

**ABUNDANCE AND SURVIVAL
OF
JUVENILE CHINOOK SALMON
IN THE
SACRAMENTO-SAN JOAQUIN ESTUARY**



**1999 ANNUAL PROGRESS REPORT
SACRAMENTO-SAN JOAQUIN ESTUARY
FISHERY RESOURCE OFFICE
U.S. FISH AND WILDLIFE SERVICE
STOCKTON, CALIFORNIA**

February 2003



**Interagency
Ecological Program**
COOPERATIVE ECOLOGICAL
INVESTIGATIONS SINCE 1970

Table of Contents

Acknowledgments.....	ii
Introduction.....	1
Methods	5
Lower Sacramento River Beach Seine.....	14
Delta Juvenile Sampling	
Delta Beach Seine.....	19
Sacramento Area Beach Seine.....	23
Lower San Joaquin River Seine	26
Kodiak and Midwater Trawl at Sacramento.....	29
Kodiak Trawl at Mossdale.....	35
Midwater Trawl at Chipps Island.....	38
Bay Seine.....	43
Absolute Abundance Estimates.....	45
1999 Mark and Recapture Studies.....	51
References	67

Acknowledgments

This sampling was conducted for and funded by the Interagency Ecological Program (IEP) for the Sacramento-San Joaquin Estuary. Members of the IEP include three state and six federal agencies: California Department of Water Resources, California Department of Fish and Game, State Water Resources Control Board, U.S. Bureau of Reclamation, U.S. Geological Survey, U.S. Fish and Wildlife Service, National Marine Fisheries Service, U.S. Army Corps of Engineers, and the U.S. Environmental Protection Agency.

Introduction

The Sacramento-San Joaquin Fishery Resource Office (SSJEFRO) has been conducting juvenile salmon sampling in the lower Sacramento River and Delta since the late 1970's. The program and its goals have evolved since then based on water management actions and endangered species listings. Prior to 1982, the program focused on monitoring juvenile salmon abundance and determining how reduced river flows would affect the survival of young salmon. After 1982 (the defeat of the Peripheral Canal), part of the focus was changed to evaluate the impact of through-Delta water conveyance on juvenile salmon survival. The greatest change in the program occurred in 1992-1993 in response to the Federal Endangered Species listing of winter run salmon. The listing required the Bureau of Reclamation to fund salmon monitoring in the lower Sacramento River and Delta between September 1 and May 31 of each year. Other listings of salmonids in the Central Valley followed. In 1998 Central Valley steelhead were federally listed as threatened and in February of 1999, spring run chinook salmon were listed as threatened by the State of California. Spring run were also federally listed in November of 1999. The program has responded by creating a sampling program that attempts to sample through-out the year at the entry (Sacramento and Mossdale) and exit (Chipps Island) points of the Delta and in the areas they reside (lower Sacramento and San Joaquin Rivers, Delta and Bay). Each year annual reports have been written to document the sampling effort and summarize findings and are available from the Stockton office.

Work in 1999 was conducted to update and refine our knowledge of the factors influencing juvenile salmon abundance, distribution, and survival in the Sacramento-San Joaquin Estuary. Field sampling and special studies were conducted between August 1, 1998, and July 31, 1999 (referred to as the 1999 field season), with various sampling gears as juveniles rear and migrate through the lower Sacramento and San Joaquin Rivers, Delta, and Bay.

Objectives of the 1999 Interagency Salmon Study were to:

- Monitor the relative abundance, distribution, and timing of juvenile chinook salmon rearing and migrating through the lower Sacramento and San Joaquin Rivers, the Delta, and portions of San Francisco Bay.
- Determine relative survival (using fall and late-fall hatchery smolts) of juvenile salmon released in the upper river and Delta, and identify potential factors influencing survival.

Midwater trawling, Kodiak trawling, and beach seining were employed at varying times and locations in the Delta, lower Sacramento and San Joaquin Rivers, and parts of the San Francisco Bay. Different sized juveniles of the various races of chinook salmon presumably have distinct spatial and temporal distributions making them vulnerable to different gear types.

Race Delineation by Size

The SSJEFRO is one of several salmon monitoring groups within the Central Valley that use size and date of capture to determine juvenile chinook salmon race in the lower Sacramento River and Delta. At this time it is the only tool used to determine race of juvenile salmon in the field. However, several problems exist regarding its validity that have been discussed in past reports (United States Fish and Wildlife Service, 1995). For these reasons, the race designations used in this report should only be used as a rough approximation and not interpreted as definitive. Research on various markers for genetic differentiation of races is ongoing and may help determine true race of Central Valley salmon juveniles sampled in the future.

Although all four races are designated in the field using the size criteria, for this report the fall and spring run categories have been combined into a group identified as fall/spring run. Spring run juveniles originating from Deer or Mill Creeks that migrate to the Delta as yearlings and would fall into the late-fall

or winter run size criteria.

Life Stage Delineation

Because designations of the various life stages of juvenile chinook depend on the physiological state of the fish, the use of fork length does not clearly define these stages but can be a rough estimate of this classification. While sac fry, fry, parr, silvery parr, smolt, and adult life stages are noted in the field, for this report we have been defined fry as being below 70 mm fork length. Juveniles larger than fry are likely starting to undergo behavioral and physiological changes to prepare them for the transition to salt water, and have defined as smolts (> 70 mm). Yearlings have been defined as juveniles residing in freshwater approximately one year.

In the field, life stage designations include sac fry, fry, parr, silvery parr, and smolt based on external characteristics including the presence or absence of an external sac, visible parr marks, or deciduous scales.

Escapement

To help understand the abundance changes of the juvenile salmon populations in the Delta, graphs of the annual number of returning adults of each race passing Red Bluff Diversion Dam (RBDD) in the upper Sacramento River, and returns to the Coleman National Fish Hatchery are shown in Figure 1. For escapement estimates to be properly obtained, the RBDD gates must be in the closed position. Since 1993, this has not occurred during late-fall upstream migration.

To estimate late-fall run escapement, carcass surveys began in 1998. Between 1993 and 1998, returns to Coleman National Fish Hatchery were used for the estimate.

Fall/spring run returns in 1999 were the eighth highest since 1978 at 48,775, although well below the 95,505 chinook that returned in 1998. Late-fall returns were only slightly lower than in 1998. Winter run numbers continued to be low, but higher than any of the previous ten years (Figure 1).

Fall run escapements in the Feather River were above average in 1999, while escapements in the American River were the sixth highest (Figure 2).

Compared with escapements during the 1980's, the Stanislaus, Tuolumne and Merced River returns through the 1990's have been low, however they have continued to increase (Figure 2).

Water Conditions During Study

The 1999 water year (October 1998 through September 1999) was classified as a wet year.

Rainfall during the 1999 water year provided above average precipitation between October and March making this the fifth consecutive wet year, something that has not occurred this century. Reservoir storage was termed excellent, and there was good snowpack through most of the state. Temperatures were cooler than during 1997 - 1998 period due to a La Nina condition that caused a severe freeze just before Christmas (Roos 1999).

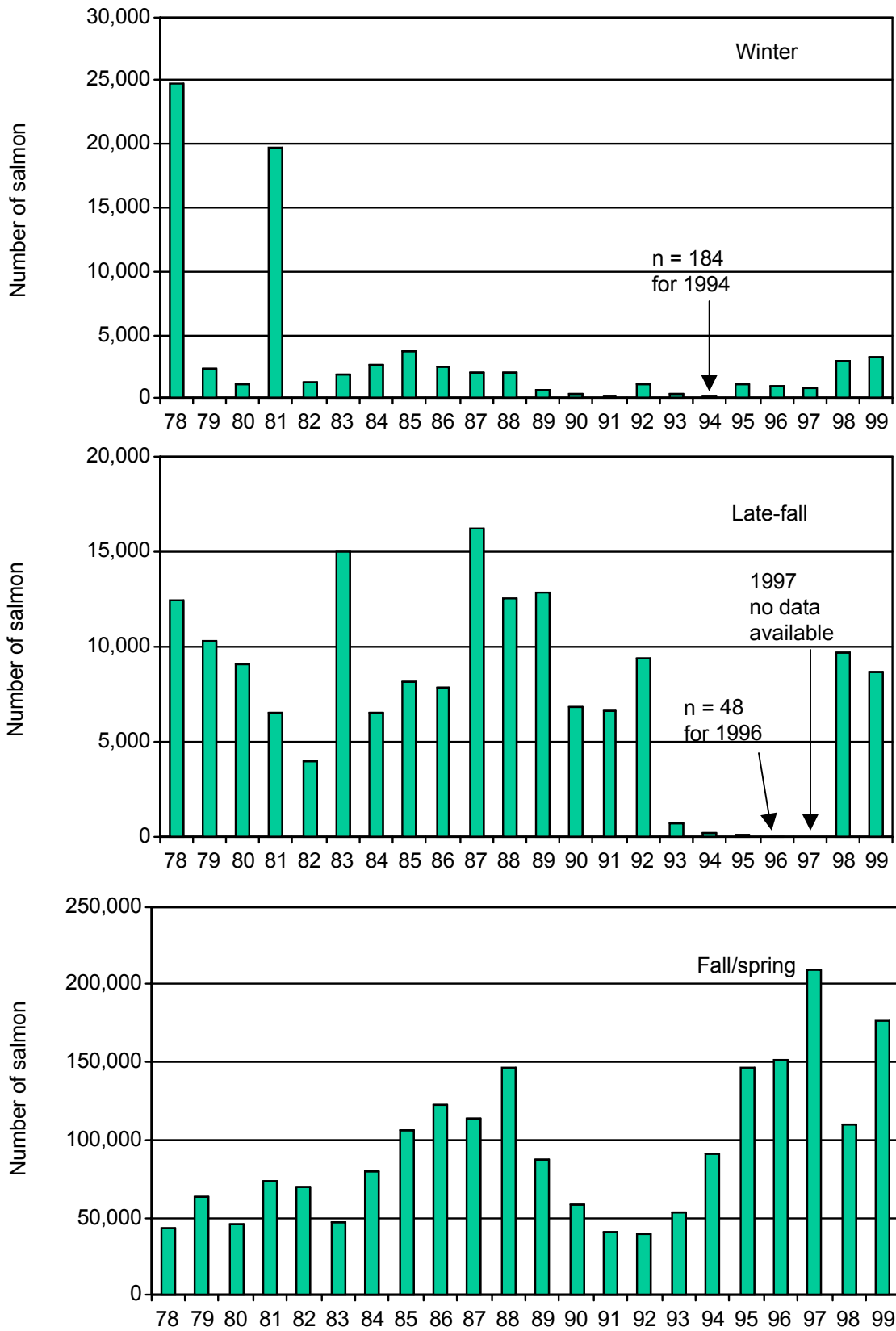

Figure 1. Red Bluff Diversion Dam yearly escapement estimates of adult winter, late-fall, and fall/spring run chinook. Source; Department of Fish and Game, Inland Fisheries Division, Red bluff. Totals for each year are the sum of both in-river and hatchery totals.

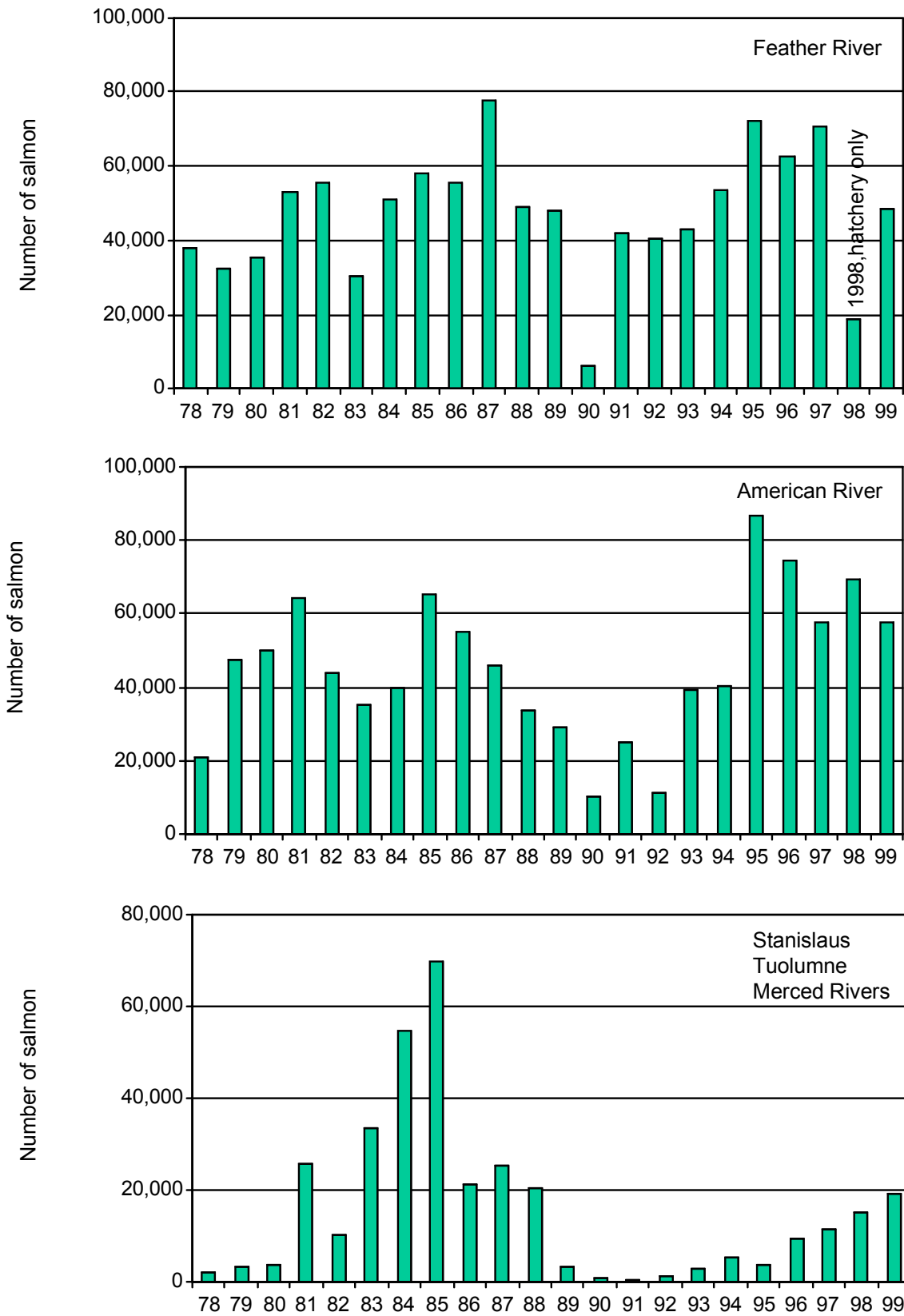

Figure 2. Spawner population estimates of fall run chinook salmon between 1978 and 1999 on the Feather and American Rivers, and the Stanislaus, Tuolumne, and Merced Rivers combined. Totals for each year are the sum of both in-river and hatchery totals.

Methods

Beach Seine

All seining was done with a 15 meter x 1.2 meter (50' x 4') 3 mm (1/8") delta square mesh beach seine with a 7.5 meter (4') long bag. One seine haul was attempted at each site. Seine sites consisted of cement boat ramps, sandy beaches, and muddy inlets. The majority of sites on the Sacramento River and Delta have been sampled since the mid-1970's to document the relative abundance of juvenile chinook salmon between and within years (Figures 3, 4, and 5). To determine relative abundance and spatial distribution of juvenile chinook in the Estuary, it is broken into seven regions: the lower Sacramento River (between Colusa and Elkhorn), Sacramento River at Sacramento (between Verona and Clarksburg), North Delta (Discovery Park to Antioch on the Sacramento River), Central Delta (between the San Joaquin River and Sacramento River), South Delta (adjacent to and south of the San Joaquin River), San Joaquin River (between Mossdale and Tuolumne River) and the Bay (downstream of Pittsburg to Tiburon in San Francisco Bay).

Beach seine sites are accessed with either a vehicle or vessel.

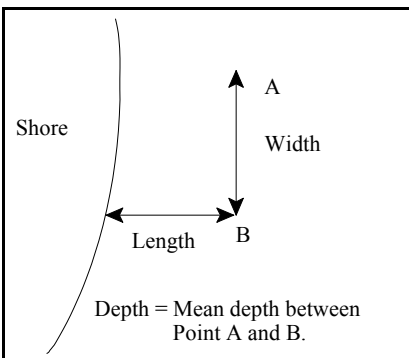

Every attempt was made to seine the original historical sites to retain validity of year to year catch per unit effort comparisons. Occasionally, changes in flow or excessive traffic prevented seining a site.

Before valid comparisons in abundance and timing within and between years were made, catches were corrected for effort by standardizing to catch per cubic meter (CPM³). Catch per cubic meter for each beach seine haul was calculated using the following equation in meters (see diagram on left):

$$\text{Seine CPM}^3 = \text{Catch} / (0.5) (\text{depth} \times \text{width} \times \text{length})$$

Midwater trawl

The midwater trawl net used at Sacramento is composed of six panels, each decreasing in mesh size towards the cod end (Figure 6). Fully extended mouth size is 1.8 meter x 4.6 meters (6' x 15') and mesh size range from 8 inch stretch at the mouth to 1/2 inch stretch just before the cod end. The cod end is composed of 1/4 inch weave mesh. Depressors made of 1/4 inch stainless steel (one on each side of the bottom of the net) are attached to the net with shackles and connected to bridles with chain and then Miller Swivels. Hydrofoils with floats spread the top of the net at water level and are attached using the same equipment as the depressors. One-hundred foot long 1/4 inch diameter Amsteel rope bridles are attached to Miller Swivels and attached to the cable from the boat. The net is fished one-hundred feet from the boat (swivels are located just aft of the a-frame). Actual fishing dimensions of the net vary due to currents and weather conditions and have been described in past reports (United States Fish and Wildlife Service, 1993). Although called a midwater trawl due to its net design, it is fished on the surface of the water.

The larger midwater trawl net used at Chipps Island (Figure 7) is similar in construction to the midwater trawl net used at Sacramento and has a mouth dimension of 3 meters x 9 meters (10'x30'). It is also towed at the surface of the water column. Six panels, each decreasing in mesh size towards the cod end. Mesh sizes ranged from 10 centimeter to 1.25 centimeter (4 inch to 1/2 inch) stretch just before the cod end. Cod end was composed of 0.8 centimeter (5/16 inch) knotless material. Depressors and hydrofoils were connected in the same manner as with the smaller Sacramento midwater trawl. The net is fished one-hundred and fifty feet aft of the vessel.

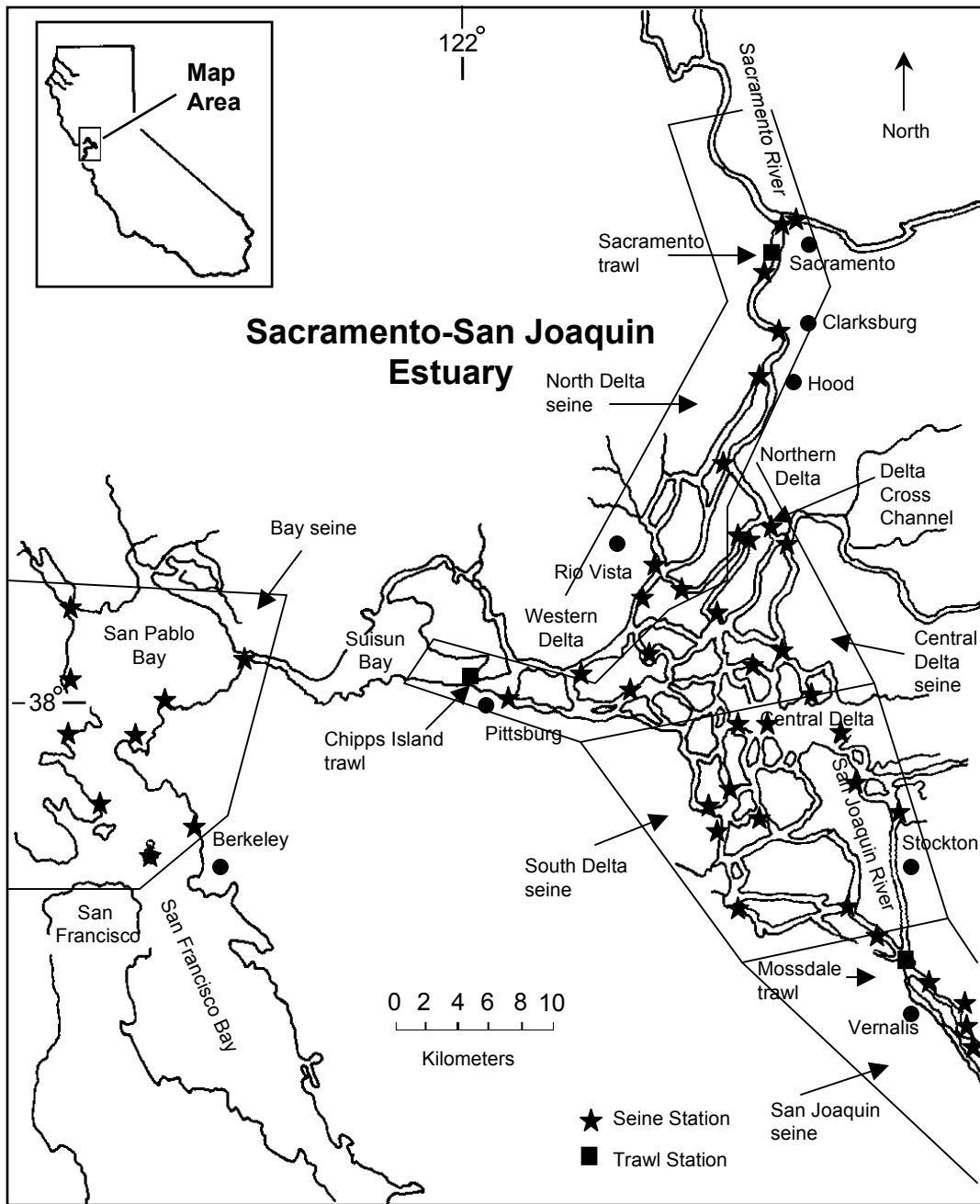

Figure 4. Sampling sites used during the 1999 field seasons in the Sacramento-San Joaquin Estuary. Beach seine and trawl recovery locations are marked with stars and squares respectively. The bordered areas show each beach seine region. Note: not all of the seine sites are shown within each region.

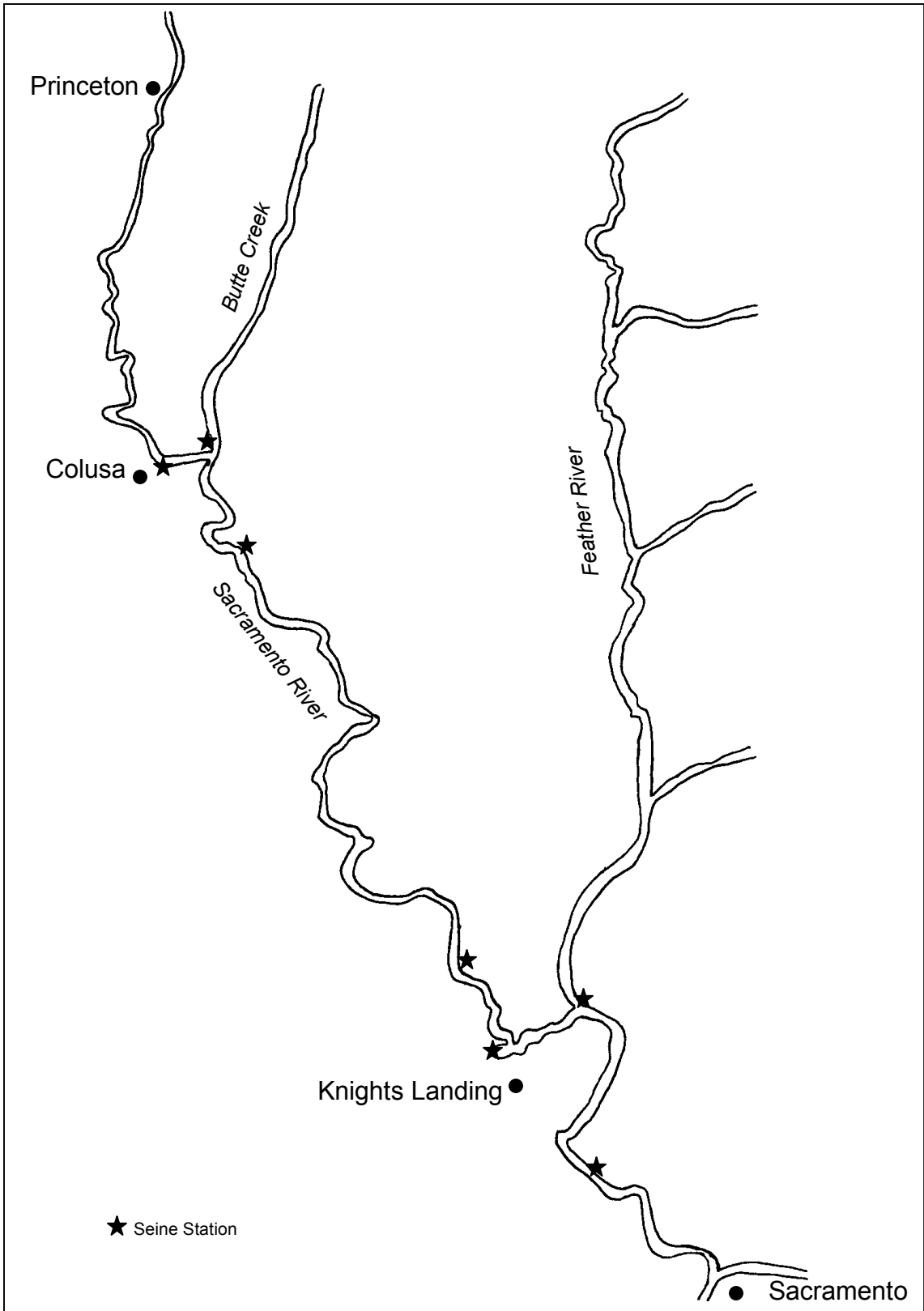

Figure 4: Lower Sacramento River beach seine sites used during the 1999 sampling season by the STFWO.

<u>Lower Sacramento River Seine</u>		<u>North Delta Seine</u>	
SR144W	Colusa State Park	SR060E	Discovery Park
SR138E	Ward's Landing	SR049E	Garcia Bend
SR130E	South Meridian	SR043E	Clarksburg
SR094E	Reels Beach	SS011N	Steamboat Sl.
SR090W	Knights Landing	SR024E	Koket
SR080E	Verona	SR017E	Isleton
SR071E	Elkhorn	SR014W	Rio Vista
<u>Central Delta Seine</u>		AM001S	American River
LP003E	Terminus	SR012E	Stump Beach
XC001N	Delta Cross Channel	MS001N	Sherman Island
GS010E	Georgiana Slough	<u>South Delta Seine</u>	
SF014E	Wimpy's	TC002E	Turner Cut
MK004W	B&W Marina	SJ032S	Lost Isle
DS002S	King's Island	SJ026N	Venice Island
SJ005N	Eddo's	WD002W	Veale Tract
TM001N	Brannon Island	OR014W	Cruiser Haven
SJ001S	Antioch Dunes (Antioch Dunes National Wildlife Refuge)	OR019E	Old River
<u>San Joaquin Seine</u>		MR010W	Woodward Island
<u>San Joaquin Seine</u>		<u>Sacramento Seine</u>	
SJ041N	Dad's Point	SR080E	Verona
SJ051E	Dos Reis	SR071E	Elkhorn
SJ056E	Mossdale	SR062E	Sand Cove
SJ058W	Wetherbee	SR060E	Discovery Park
SJ063W	Big Beach	SR057E	Miller Park
SJ068W	Durham	SR055E	Sherwood Harbor
SJ074W	Sturgeon Bend	SR049E	Garcia Bend
SJ077E	Route 132	SR043E	Clarksburg
SJ083W	North of Tuolumne River	<u>Trawls</u>	
SJ086W	Grayson	SA010W	SB018 Chipps Island
<u>Bay Seine (West)</u>		<u>Bay Seine (East)</u>	
SA004W	Tiburon	SA001M	Treasure Island
SA008W	Paradise Beach	SA007E	Berkeley Frontage
SP001W	China Camp	SP000E	Pt. Molate
SP000W	McNear's Beach	SA009E	Keller Beach
		SP003E	Point Pinole East
			SR055M Sacramento

Figure 5: Station codes and names for all gears used by SSJEFRO in 1999. The beach seine sites in the Lower Sacramento River sampling area are upstream of the city of Sacramento on the Sacramento River (RM 60). The North Delta seine sites are south of Sacramento on the Sacramento River. The Central Delta seine sites are between the Sacramento and San Joaquin Rivers and the South Delta seine sites are located in the interior Delta south of the San Joaquin River. The San Joaquin River seine sites are upstream of Dos Reis Park (RM 51) on the San Joaquin River. The Sacramento seine ranges from Verona (RM 80) to Clarksburg (RM 43) on the Sacramento River and consists of three sites exclusively for the Sacramento area seine: Sand Cove, Miller Park, and Sherwood Harbor. Bay seine sites are west of Pittsburg to McNear's Beach (SF Bay).

Ten twenty minute trawls were done per sample day at both locations. All trawling at Sacramento was done in the middle of the channel facing upstream against the current within 1.5 kilometers of the sample site. Trawling at Chipps Island also was done within 1.5 kilometers from the sample site in both directions regardless of tide, and in three channel locations: North, South, and middle. Occasionally, inclement weather, mechanical problems, or excessive fish catches required reducing tow times or the number of tows. During the spring of 1999, 2 shifts of 10, twenty minute tows were conducted at Chipps Island. This is discussed in more detail in the mark and recapture section of this report.

The net mouth area in the small and large midwater trawl nets used for calculations were actual estimated net mouth fishing areas. Previous studies showed that the midwater trawl nets don't open completely while under tow (United States Fish and Wildlife Service, 1993) and that mouth dimensions vary within and between tows. Catch by cubic meter (CPM³) per tow in the midwater trawl was calculated with the following formula:

$$\text{CPM}^3 = \frac{\text{catch per tow}}{\text{net mouth area (m}^2\text{) X distance net passes through water column(m)}}$$

Estimated net mouth areas used in this report were the mean mouth openings calculated from these studies. The estimated net mouth areas while fishing were 5.1 square meters for the small midwater trawl used at Sacramento and 18.6 square meters for the large midwater trawl used at Chipps Island. The distance the net passes through the water column defined in meters was measured during each tow with a General Oceanics mechanical flow meter (model 2030). Total revolutions per tow were counted by the flow meter and converted to linear distance using standard equations as described in the General Oceanics manual. This is a measurement of the distance of water sampled and is not related to distance traveled relative to land which can be effected by tides and currents.

Kodiak trawl

The Kodiak trawl net also is variable mesh with a fully expanded mouth opening of 1.83 x 7.62 meters (6 x 25 feet) and is shown in Figure 8. The estimated fishing net mouth area, extrapolated from midwater trawl studies (United States Fish and Wildlife Service, 1993), is 12.5 square meters for the Kodiak trawl. A float line and lead line enable the net to fish the top 1.8 meters of the water column. At the front of each wing is a 1.8 meter bar keeping this depth constant. The Kodiak trawl is fished with an aluminum live box as a cod end to avoid excessive fish mortality. Two boats tow the Kodiak net through the water, one pulling each wing. At the end of each tow, field crews on one of the boats retrieve the live box from the end of the net and remove the fish. The method used to calculate CPM³ per tow is the same as the midwater trawl.

Daily, weekly, and monthly CPUE calculations

Data was summarized using monthly CPM³ values. The average monthly CPM³, unless otherwise specified, was calculated based on the daily and weekly averages as shown in the following formulas.

$$\text{Average Daily CPM}^3 = \frac{\sum_{i=1}^3 (\text{site/tow CPM}^3)}{\text{\# sites/tows sampled in each day}}$$

$$\text{Average Weekly CPM}^3 = \frac{\sum_{i=1}^3 (\text{daily CPM}^3)}{\text{\# days sampled in each week}}$$

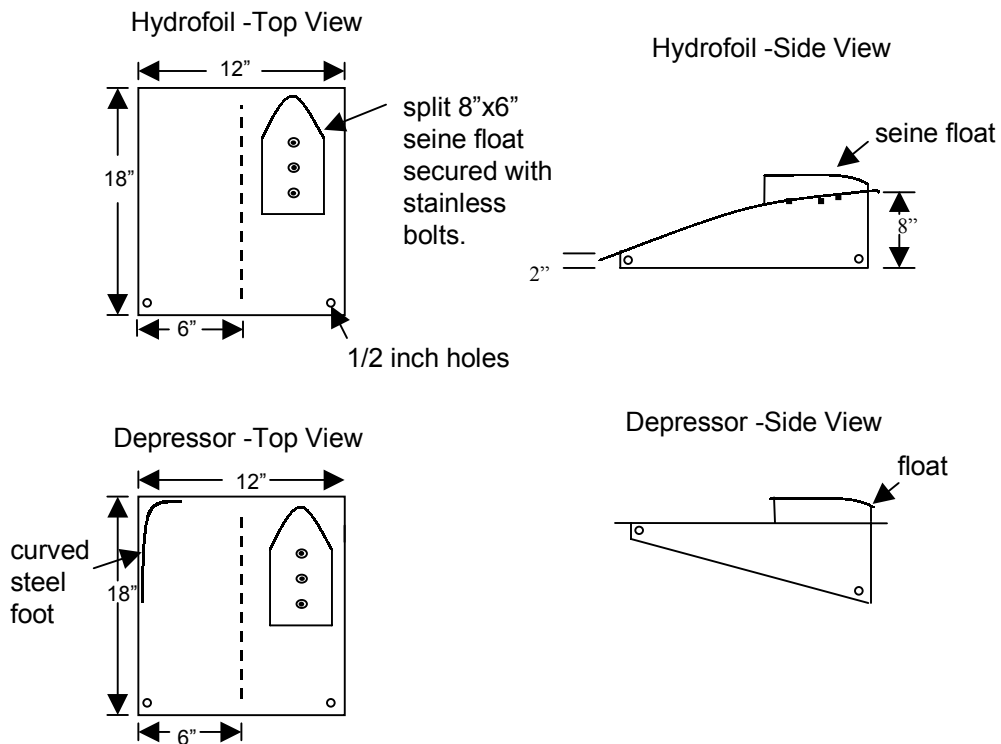
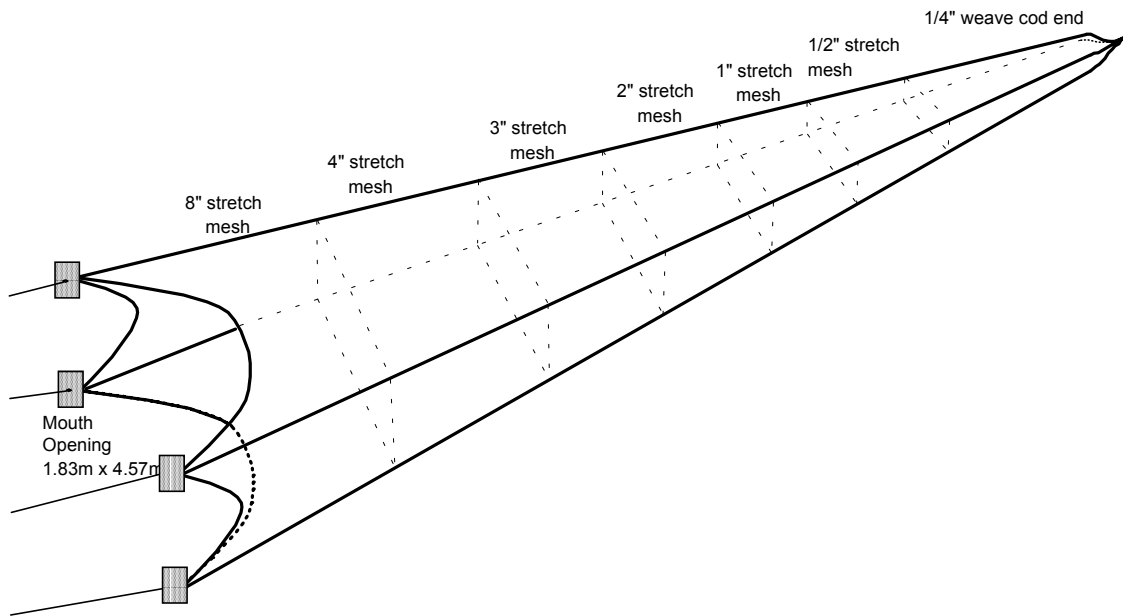
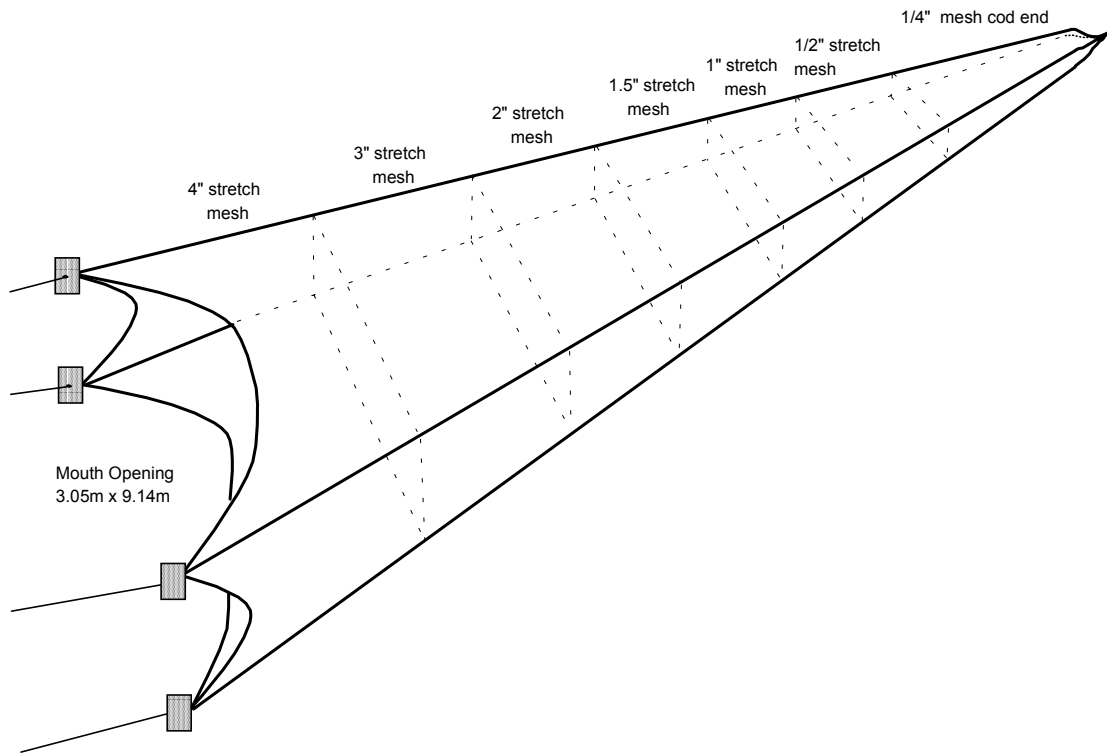
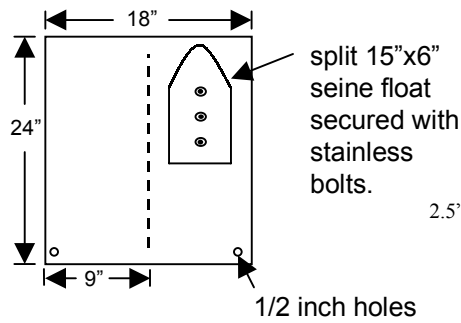

Figure 6. Schematic drawing of the midwater trawl net (top), and depressors and hydrofoils (bottom) used at Sacramento during the 1999 field season.



Hydrofoil -Top View



Hydrofoil -Side View

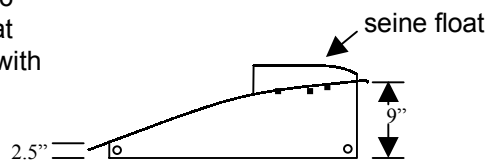

Depressor -Top View

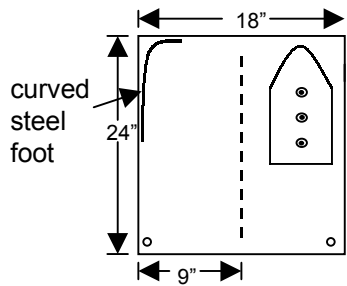

Depressor -Side View

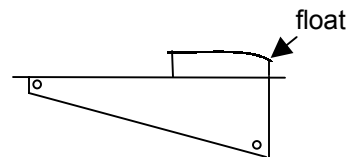

Figure 7. Schematic drawing of the midwater trawl net (top), and depressors and hydrofoils (bottom) used at Chipps Island during the 1999 field season.

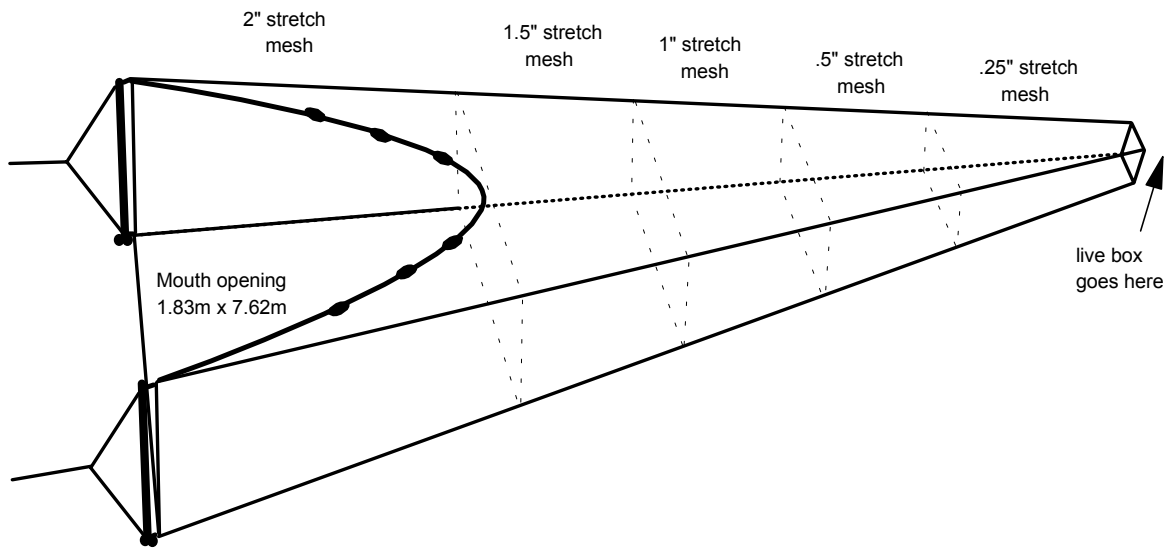

Figure 8. Schematic drawing of the Kodiak trawl net used at Sacramento during the 1999 field season.

$$\text{Average Monthly CPM}^3 = \frac{\sum_{i=1}^3 (\text{weekly CPM}^3)}{\text{\# weeks sampled in each month}}$$

The monthly CPM³ was the sum of weekly CPM³ divided by the number of weeks sampled per month. Weeks were designated as Monday-Sunday and weeks which overlap months were split and included in their respective months. Each average weekly CPM³ was calculated by averaging all daily means within the week. The daily CPM³ was the average of all tows for trawl or all seine sites for each day.

Lower Sacramento River Beach Seine

To estimate the relative abundance of juvenile chinook salmon in the lower Sacramento River, beach seining was conducted at nine sites once per week from August 1, 1998, through July 31, 1999. The area sampled was from Colusa (rm 144) downstream to Elkhorn (rm 71). The substrates sampled were sand and paved boat ramps.

1999 Field Season

A total of 74 winter run were captured in the lower Sacramento River beach seine during the 1999 field season. Except for one fry (35 mm) captured in September all winter run were captured during two periods that began with increasing flows. The first of these periods began in November when highest catch and CPM³ were recorded. Both periods began with high CPM³s and then tapered off (Figure 9). Monthly peaks in winter run abundance in the lower Sacramento River beach seine were earlier in 1999 (November) than in past years where peaks were generally observed in December and January (Table 1).

Late-fall spawning occurs between January and late April. Juveniles enter the Delta as fry in the spring/summer or as smolts/yearlings in the fall/winter. These different life history characteristics within a brood year causes catches from multiple brood years to occur in one field year (August - July). A total of 47 smolt/yearling sized late-fall chinook were captured between November and December from the 1998 brood year. Size ranged between 83 and 134 mm fork length. Peak CPM³ was in November just before the first high flow event of the season. Two late-fall juveniles were captured in August, the third time in the seven years shown in Figure 10. In April and May, a total of four brood year 1999 late-fall run fry were captured (Figure 9 and 10). Past mean monthly peaks were observed in December with the exception of 1993-1994, when the monthly peak was observed in October (Table 2)

The most abundant race captured in the lower Sacramento River during the 1999 field season was fall/spring. Size ranged between 29 and 105 mm fork length. Catches occurred throughout the season except during September and October with the peak catch and CPM³ occurring in March during a period of high flows (Figure 9). Mean monthly peak catch per cubic meter in past years has been in January or February with the exception of 1992-1993 when it was also in March (Table 3)

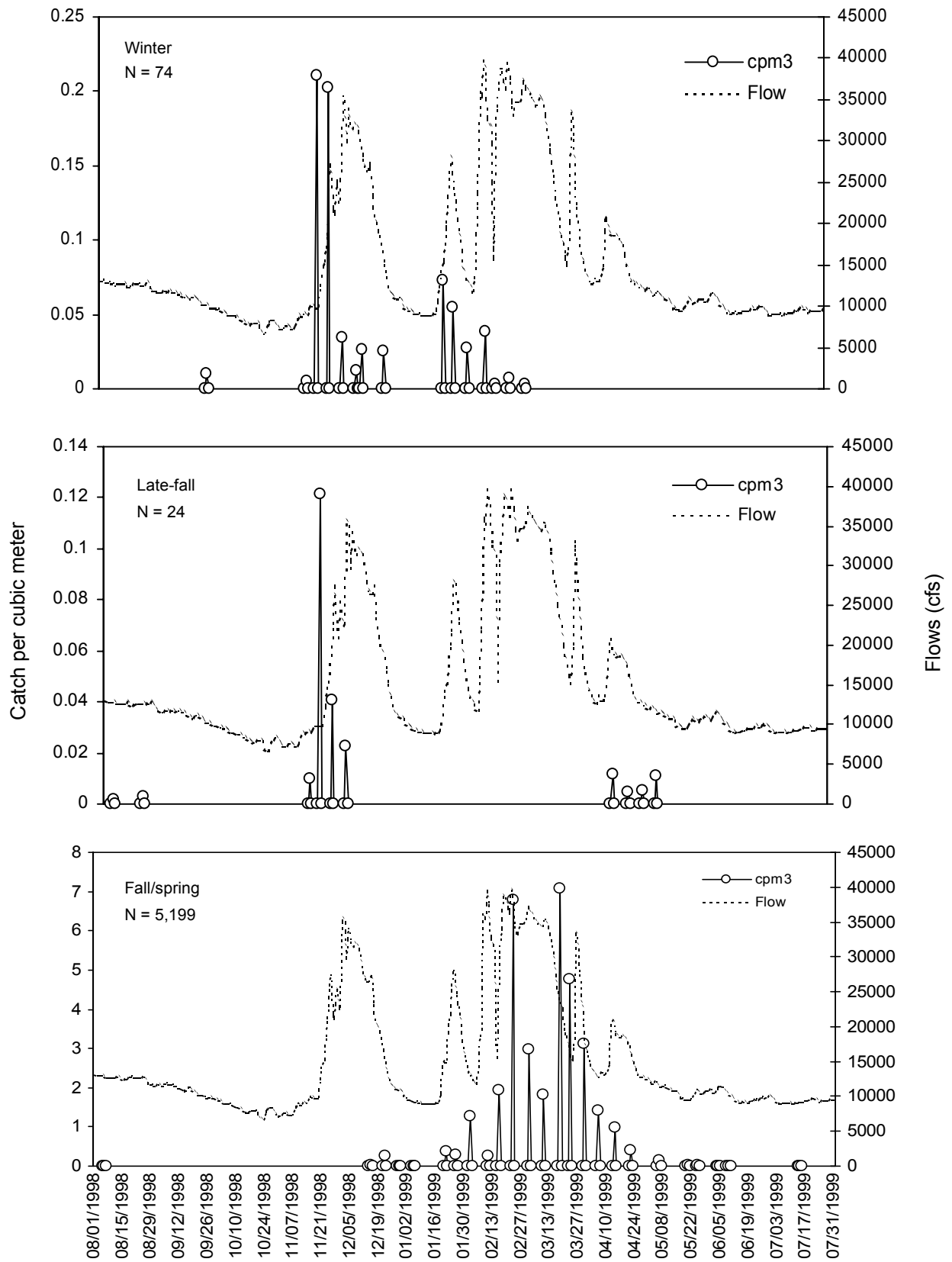

Figure 9. Daily catch per cubic meter in the lower Sacramento River beach seine during the 1999 field season, and flow measured at Colusa (cfs).

Table 1. Lower Sacramento River beach seine **winter run** raw catch, catch per cubic meter x's 100 (in parenthesis), and maximum monthly statistics for each year of between the 1993 and 1999 field seasons. Peak catch per cubic meter values are highlighted. Water year type (C = critical, D = dry, BN = below normal, AN = above normal, W = wet), average (Aver), average (Aver) catch and CPM³ per year are also shown. NS = no sample.

Field season	Water year	Aug	Sep	Oct	Nov	Dec	Jan	Feb	Mar	Apr	May	Jun	Jul	Aver
1992 - 1993	AN	NS	2 (0.110)	0	15 (1.870)	18 (0.650)	52 (2.300)	30 (2.300)	0	0	0	0	0	10.6 (0.657)
1993 - 1994	C	0	0	2 (0.016)	0	5 (0.052)	7 (0.369)	12 (0.853)	0	0	0	0	0	2.0 (0.108)
1994 - 1995	W	0	0	0	7 (0.019)	2 (0.064)	53 (1.626)	4 (0.140)	12 (0.157)	0	0	0	0	6.5 (0.167)
1995 - 1996	W	0	0	0	0	119 (3.046)	45 (1.365)	14 (0.662)	4 (0.305)	1 (0.031)	0	0	0	15.3 (0.451)
1996 - 1997	W	0	0	0	0	34 (3.515)	0	7 (0.428)	4 (0.255)	0	0	0	0	3.8 (0.350)
1997 - 1998	W	0	0	0	36 (3.300)	48 (3.710)	48 (3.724)	0	0	0	0	0	0	11.0 (0.895)
1998 - 1999	W	0	1 (0.265)	0	92 (15.85)	114 (9.433)	41 (3.631)	14 (1.922)	1 (0.056)	0	0	0	0	21.92 (2.596)

Table 2. Lower Sacramento River beach seine **late-fall run** raw catch, catch per cubic meter x's 100 (in parenthesis), and maximum monthly statistics for each year of between the 1993 and 1999 field seasons. Peak catch per cubic meter values are highlighted. Water year type (C = critical, D = dry, BN = below normal, AN = above normal, W = wet), average (Aver), average (Aver) catch and CPM³ per year are also shown. NS = no sample.

Field season	Water year	Aug	Sep	Oct	Nov	Dec	Jan	Feb	Mar	Apr	May	Jun	Jul	Aver
1992 - 1993	AN	NS	0	1 (0.030)	1 (0.070)	1 (0.090)	1 (0.040)	1 (0.030)	0	2 (0.260)	10 (0.370)	0	0	1.5 (0.081)
1993 - 1994	C	1 (0.034)	2 (0.021)	29 (0.405)	10 (0.079)	9 (0.128)	1 (0.013)	1 (0.085)	0	0	0	0	0	4.4 (0.064)
1994 - 1995	W	0	0	0	2 (0.027)	10 (0.438)	7 (0.502)	0	0	0	2 (0.126)	0	0	1.8 (0.091)
1995 - 1996	W	4 (0.091)	0	0	0	14 (0.403)	2 (0.105)	0	0	0	0	1 (0.038)	0	1.8 (0.053)
1996 - 1997	W	0	0	0	1 (0.014)	6 (0.545)	0	0	0	0	0	0	0	0.6 (0.047)
1997 - 1998	W	0	0	0	0	12 (0.825)	1 (0.032)	0	0	0	2 (0.300)	7 (0.769)	0	1.8 (0.161)
1998 - 1999	W	2 (0.111)	0	0	26 (2.127)	21 (1.352)	0	0	0	3 (0.537)	1 (0.281)	0	0	4.3 (0.474)

Table 3. Lower Sacramento River beach seine **fall/spring run** raw catch, catch per cubic meter x's 100 (in parenthesis), and maximum monthly statistics for each year of between the 1993 and 1999 field seasons. Peak catch per cubic meter values are highlighted. Water year type (C = critical, D = dry, BN = below normal, AN = above normal, W = wet), average (Aver), average (Aver) catch and CPM³ per year are also shown. NS = no sample.

Field season	Water year	Aug	Sep	Oct	Nov	Dec	Jan	Feb	Mar	Apr	May	Jun	Jul	Aver
1992 - 1993	AN	NS	0	0	0	25 (1.415)	240 (7.855)	307 (11.4)	327 (20.65)	549 (16.61)	162 (5.49)	4 (0.63)	0	146.6 (5.822)
1993 - 1994	C	2 (0.068)	0	1 (0.011)	0	146 (6.446)	571 (12.09)	888 (63.90)	594 (48.56)	258 (6.610)	97 (1.734)	0	0	191.5 (11.62)
1994 - 1995	W	0	0	0	0	15 (0.912)	1,641 (219.3)	1,716 (183.7)	1,321 (151.1)	279 (36.88)	186 (19.09)	18 (2.09)	1 (0.052)	431.4 (51.1)
1995 - 1996	W	2 (0.042)	0	0	0	1,028 (43.74)	2,345 (158.8)	3,854 (274.4)	2,043 (190.8)	282 (22.25)	46 (13.94)	0	1 (0.023)	800.1 (58.67)
1996 - 1997	W	0	0	0	0	289 (20.05)	500 (162.4)	711 (94.48)	354 (56.61)	121 (7.582)	9 (0.559)	1 (0.042)	0	165.4 (20.61)
1997 - 1998	W	0	0	0	0	100 (21.89)	1,649 (137.1)	44 (10.06)	377 (50.16)	161 (32.62)	140 (36.62)	17 (1.817)	2 (0.556)	207.5 (24.24)
1998 - 1999	W	1 (0.045)	0	0	3 (0.393)	266 (26.01)	1,667 (184.4)	1,582 (255.7)	2,985 (395.5)	405 (72.58)	56 (27.63)	3 (0.353)	2 (0.206)	580.8 (80.23)

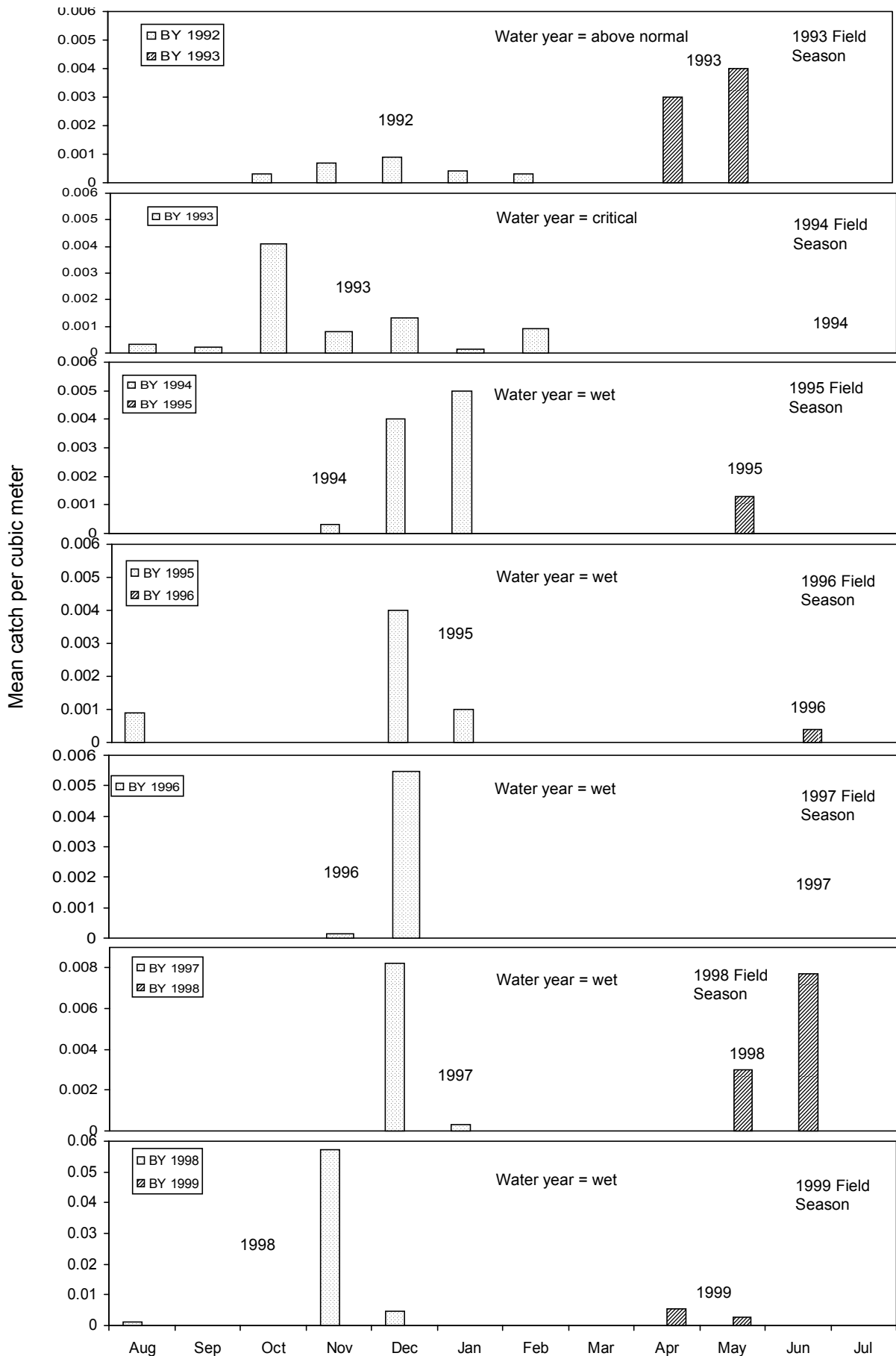

Figure 10. Mean catch per cubic meter of late-fall chinook in the lower Sacramento River beach seine; brood years (BY) 1992 through 1999.

**Delta Juvenile Sampling
Beach Seine
(North, Central, and South Delta)**

Delta beach seining was conducted from August 1, 1998, to July 31, 1999. A total of ten North Delta sites were sampled weekly, and ten Central and nine South Delta sites were sampled between one and two times per month (Figures 3 and 4).

1999 Field Season

Winter run catches were the third highest over a seven year period, and down only slightly from 1998. For the first time since this seine route began in 1976, fry were captured in September. On September 22, one winter run fry was captured at Clarksburg, then three were captured on September 30 at Discovery Park and Koket. These four fry were captured nearly two months earlier than any other winter run have been detected in the Delta. The majority of winter run were detected during high flow events (Figure 11). In 1998-1999 field year the monthly peak of winter run was detected in November, earlier than in past years where it has ranged between December and February (Table 4).

Catches of late-fall juveniles occurred between November 25, 1998, and May 4, 1999, and were first detected during a period of increasing flows. A total of seven yearlings from the 1998 brood year and 17 fry from the 1999 brood year were captured (Figure 11). The monthly peak was in November in 1999, similar to 1992-1993. All other years observed the monthly peak in December or January. The 1995-1996 field year was the only year with the peak observed in February (Table 5).

As in past years, fry fall/spring run catches began at the onset of the seasons first significant flow event in December, however, it was not until the end of January, at the beginning of a second period of high flows that large numbers of fry were captured (Figure 11). The monthly peak in 1999 was observed in March. In past years the peak has been in February or March (Table 6).

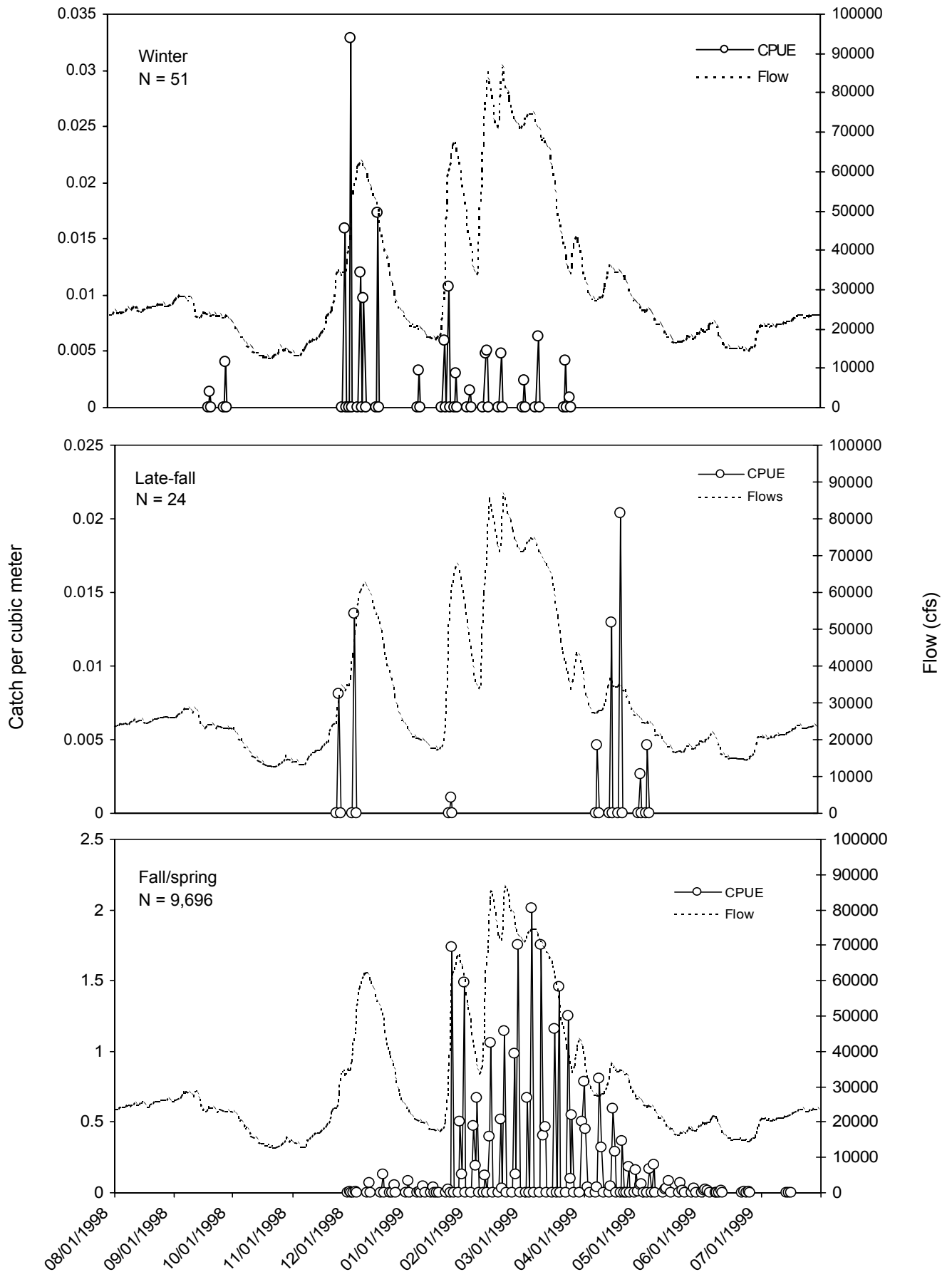

Figure 11. Daily catch per cubic meter (CPM³) in the Delta area beach seine during the 1999 field season, and flow at Freeport.

Table 4. Delta beach seine **winter run** raw catch, catch per cubic meter x's 100 (in parenthesis), and maximum monthly statistics for each year of between the 1993 and 1999 field seasons. Peak catch per cubic meter values are highlighted. Water year type (C = critical, D = dry, BN = below normal, AN = above normal, W = wet), average (Aver), average (Aver) catch and CPM3 per year are also shown. NS = no sample.

Field season	Water year	Aug	Sep	Oct	Nov	Dec	Jan	Feb	Mar	Apr	May	Jun	Jul	Aver
1992 - 1993	AN	NS	0	0	9 (0.310)	4 (0.110)	7 (0.640)	7 (0.300)	1 (0.070)	0	0	0	NS	2.3 (0.130)
1993 - 1994	C	NS	0	0	0	0	0	2 (0.140)	0	0	0	0	0	0.2 (0.012)
1994 - 1995	W	0	0	0	0	0	6 (0.306)	4 (0.158)	1 (0.017)	0	0	0	0	0.9 (0.043)
1995 - 1996	W	0	0	0	0	73 (1.129)	39 (0.562)	20 (0.686)	5 (0.101)	2 (0.066)	0	0	0	11.6 (0.212)
1996 - 1997	W	0	0	0	1 (0.049)	2 (0.075)	1 (0.135)	2 (0.060)	3 (0.040)	0	0	0	0	0.8 (0.030)
1997 - 1998	W	0	0	0	5 (0.434)	42 (1.217)	9 (0.197)	1 (0.053)	1 (0.036)	0	0	0	0	4.8 (0.161)
1998 - 1999	W	0	4 (0.054)	0	47 (1.851)	53 (1.725)	13 (0.212)	4 (0.136)	7 (0.136)	0	0	0	0	10.7 (0.343)

Table 5. Delta beach seine **late-fall run** raw catch, catch per cubic meter x's 100 (in parenthesis), and maximum monthly statistics for each year of between the 1993 and 1999 field seasons. Peak catch per cubic meter values are highlighted. Water year type (C = critical, D = dry, BN = below normal, AN = above normal, W = wet), average (Aver), average (Aver) catch and CPM3 per year are also shown. NS = no sample.

Field season	Water year	Aug	Sep	Oct	Nov	Dec	Jan	Feb	Mar	Apr	May	Jun	Jul	Aver
1992 - 1993	AN	NS	0	0	2 (0.080)	1 (0.040)	1 (0.080)	0	0	0	0	6 (0.340)	NS	1 (0.058)
1993 - 1994	C	NS	0	0	0	3 (0.065)	3 (0.074)	0	0	0	0	0	0	0.5 (0.013)
1994 - 1995	W	0	0	0	1 (0.007)	9 (0.068)	4 (0.180)	1 (0.013)	0	1 (0.039)	3 (0.050)	0	0	1.6 (0.030)
1995 - 1996	W	0	0	0	0	6 (0.098)	2 (0.034)	2 (0.103)	0	1 (0.017)	7 (0.064)	0	1 (0.029)	1.6 (0.029)
1996 - 1997	W	0	0	0	3 (0.025)	2 (0.041)	1 (0.206)	0	0	1 (0.212)	1 (0.139)	0	0	0.7 (0.052)
1997 - 1998	W	0	0	0	1 (0.022)	7 (0.304)	0	0	0	18 (0.635)	4 (0.112)	10 (0.064)	0	3.3 (0.095)
1998 - 1999	W	0	0	1 (0.015)	9 (0.413)	7 (0.223)	2 (0.133)	0	0	14 (0.336)	3 (0.058)	0	0	3 (0.098)

Table 6. Delta beach seine **fall/spring run** raw catch, catch per cubic meter x's 100 (in parenthesis), and maximum monthly statistics for each year of between the 1993 and 1999 field seasons. Peak catch per cubic meter values are highlighted. Water year type (C = critical, D = dry, BN = below normal, AN = above normal, W = wet), average (Aver), average (Aver) catch and CPM3 per year are also shown. NS = no sample.

Field season	Water year	Aug	Sep	Oct	Nov	Dec	Jan	Feb	Mar	Apr	May	Jun	Jul	Aver
1992 - 1993	AN	NS	0	0	0	11 (0.265)	156 (6.545)	283 (7.305)	756 (28.53)	1,048 (14.32)	98 (2.175)	17 (1.530)	NS	236.9 (5.515)
1993 - 1994	C	NS	0	0	2 (0.056)	12 (0.287)	119 (3.608)	1,943 (49.34)	582 (11.65)	115 (4.836)	24 (0.828)	3 (0.014)	0	233.3 (6.42)
1994 - 1995	W	0	1 (0.031)	0	0	16 (0.346)	3,357 (67.92)	3,394 (84.15)	4,716 (120.4)	1,132 (23.33)	265 (4.569)	27 (0.540)	1 (0.021)	1,075.8 (25.11)
1995 - 1996	W	0	0	0	0	1,261 (13.29)	3,159 (44.82)	7,927 (166.9)	4,724 (83.43)	720 (13.52)	106 (2.206)	6 (0.111)	4 (0.158)	1492.3 (27.04)
1996 - 1997	W	0	0	0	0	725 (18.23)	829 (40.86)	1,341 (47.35)	1,159 (29.94)	500 (10.97)	34 (1.906)	3 (0.061)	0	382.6 (12.44)
1997 - 1998	W	1 (0.021)	0	0	0	56 (1.553)	1,490 (48.08)	1,419 (81.51)	2,232 (59.66)	1,062 (24.73)	278 (6.849)	48 (0.811)	0	548.8 (18.50)
1998 - 1999	W	0	0	0	8 (0.507)	194 (3.862)	1,132 (24.89)	2,801 (62.95)	4,181 (105.1)	1,287 (25.19)	247 (6.228)	22 (0.447)	1 (0.016)	822.8 (19.10)

Sacramento Area Beach Seine

On September 21, 1994, an additional beach seine route combining the two downstream sites of the lower Sacramento River seine with the three upper sites of the North Delta Area seine began on a seasonal basis. Three new sites were also included on this route (Figures 3 and 4). This seining was conducted in addition to normal sampling to capture winter run fry and winter, late-fall and spring run yearlings as they enter the Delta to help in managing water project operations. Sampling generally has been conducted three to seven days per week, October through February. This is the first year that this seine route has been included in the annual report, and comparisons to previous years have not been done.

1999 Field Season

There were two peak CPM³ periods for winter run, one at the beginning of the first high flow event, and again at the beginning of the second high flow event. (Figure 12 and Table 7).

Catches of late-fall juveniles occurred between October 21, 1998, and January 8, 1999. A total of 54 yearlings from the 1998 brood year were ranging from 88 mm to 134 mm.(Figure 12 and Table 7). Peak CPM³ occurred just before the first period of high flows.

Fall/spring run were first detected as flows increased, and as with the other two seine routes, large numbers weren't captured until December. The highest catch and CPM³ occurred on the last day of the season (January 29, 1999) just after the second period of peak flows (Figure 12 and Table 7).

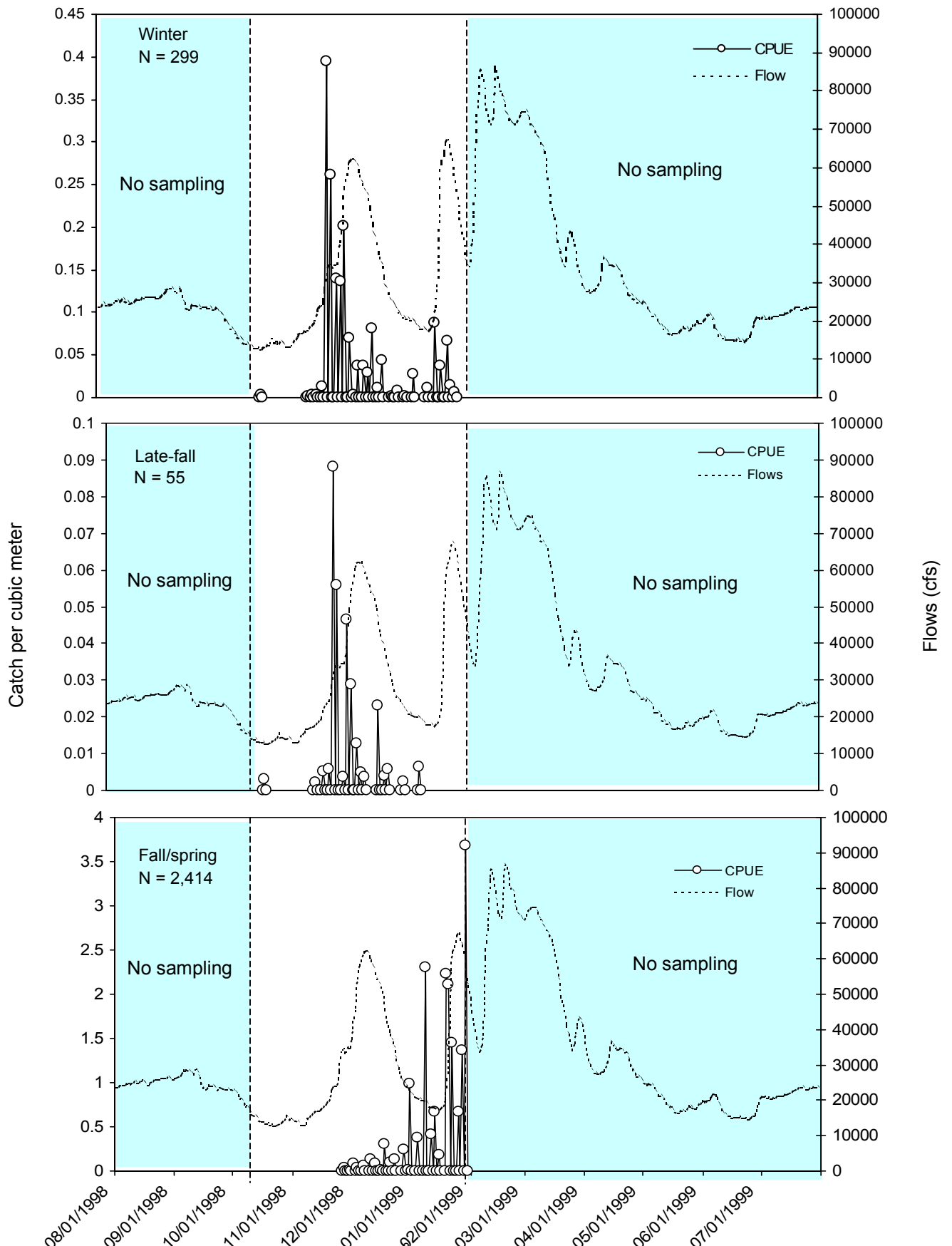

Figure 12. Daily catch per cubic meter (CPM) in the Sacramento area beach seine during the 1999 field season, and flow at Freeport.

Table 7 . Sacramento area beach seine **fall/spring, late-fall, and winter run** raw catch, catch per cubic meter x's 100 (in parenthesis), and maximum monthly statistics for the 1999 field season. Peak catch per cubic meter values are highlighted. Average (Aver) catch and CPM³ are also listed. NS = no sample

Race	Aug	Sep	Oct	Nov	Dec	Jan	Feb	Mar	Apr	May	Jun	Jul	Aver
Fall/spring	NS	NS	0	10 (0.492)	532 (14.93)	1,872 (144.3)	NS	NS	NS	NS	NS	NS	603.5 (39.93)
Late-fall	NS	NS	1 (0.050)	24 (1.123)	29 (1.132)	1 (0.052)	NS	NS	NS	NS	NS	NS	13.8 (0.589)
Winter	NS	NS	1 (0.053)	111 (8.512)	151 (5.536)	36 (2.121)	NS	NS	NS	NS	NS	NS	74.8 (4.056)

San Joaquin River Beach Seine

The lower San Joaquin River beach seine was started in 1994, to document the relative abundance and distribution of San Joaquin River chinook salmon. Seining has been conducted once per week, between January and June, each year.

All San Joaquin River chinook have been classified as fall run since spring run chinook were eliminated from the three San Joaquin River tributaries (Stanislaus, Tuolumne, and Merced) by 1930 and from the mainstem by 1947 as a result of dam construction (U.S. Fish and Wildlife Service, 1995).

1999 field season

In 1999, sampling was conducted from January 5 through June 30. Unlike the previous two years when high flows prevented access to the sites, all sites were accessible throughout the season. 1999 recorded the highest catches and CPM³ of the six years that sampling has been conducted on the San Joaquin River. A total of 1,302 juveniles were captured in 1999, nearly 4 times the number of chinook captured in the previous five years combined (Figure 13 and Table 8). Peak monthly catch was observed in February in 1999. In some years the peak can be as late as April (Table 8).

Figure 13 shows flow and CPM³ between 1994 and 1999. In 1994, a critical water year, chinook were captured only in April, and CPM³ was the second lowest for the six year period. The next five years were wet, and generally, CPM³ increased over that period. In January 1997, as flows reached flood stages, most of the seine sites were inaccessible, and no chinook were captured until March, during a period of decreasing flows. Chinook were sampled from January through May of 1998, a wet year, when the first large number of chinook were captured just prior to a period of increased flows. In 1999, the first large groups of fish to move occurred as flows were increasing.

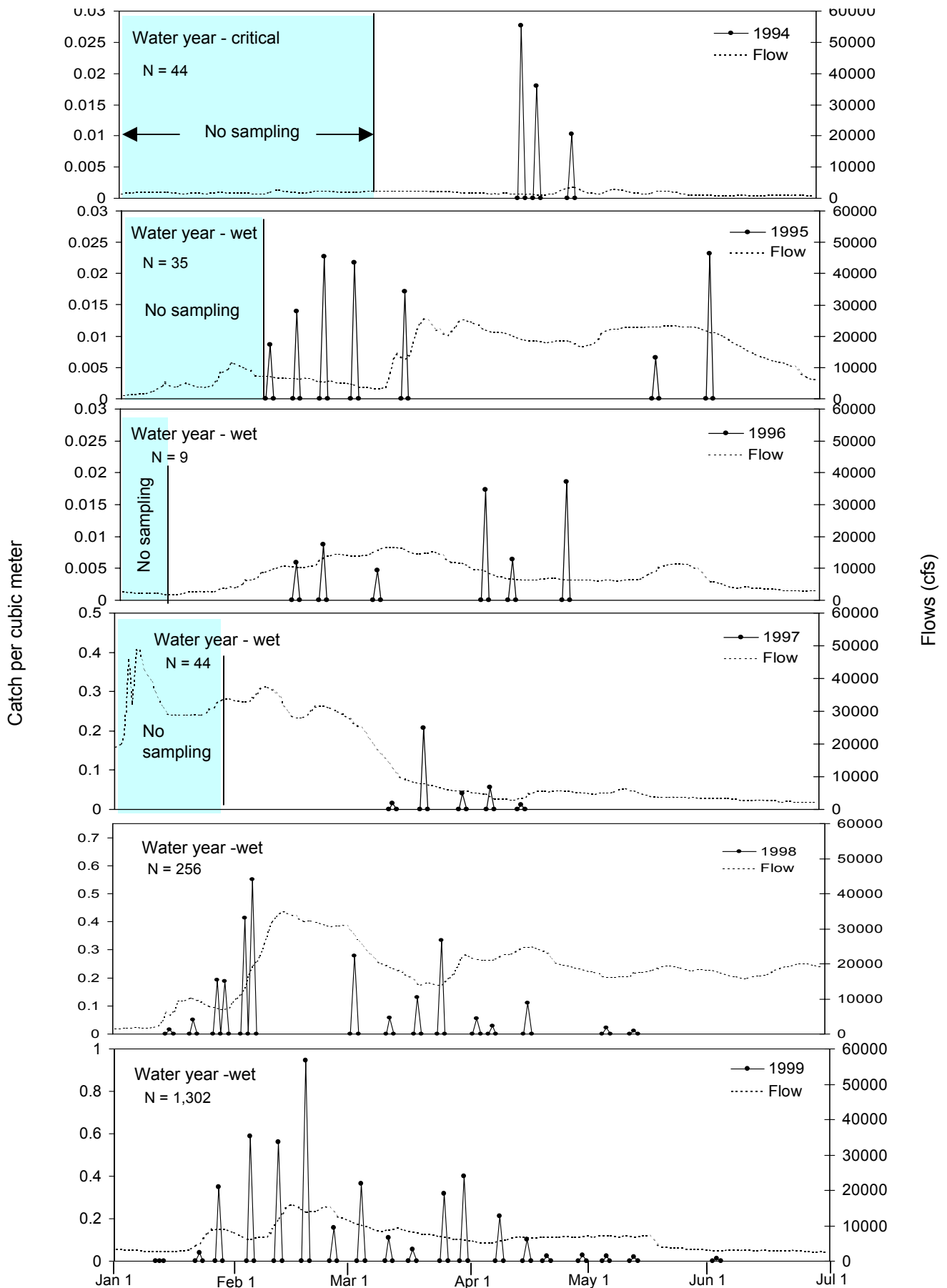

Figure 13. Daily catch per cubic meter for fall run chinook in the San Joaquin beach seine, and mean daily flow at Vernalis, 1994 to 1999.

Table 8. San Joaquin River beach seine **fall run** catch, catch per cubic meter x's 100 (in parenthesis), and maximum monthly statistics for each year between 1993 and 1999 field season. Peak catch per cubic meter values are highlighted. Water year type (C = critical, D = dry, BN = below normal, AN = above normal, W = wet), average (Aver) catch and CPM³ per year are also shown. * = sampled only one day in February 1998. NS = Not sampled.

Field season	Water year	Aug	Sep	Oct	Nov	Dec	Jan	Feb	Mar	Apr	May	Jun	Jul	Aver
1993 - 1994	C	NS	NS	NS	NS	NS	NS	NS	0	44 (1.99)	0	0	NS	7.3 (0.330)
1994 - 1995	W	NS	NS	NS	NS	NS	NS	14 (1.510)	18 (0.970)	0	1 (0.220)	2 (0.770)	NS	5.8 (0.580)
1995 - 1996	W	NS	NS	NS	NS	NS	0	2 (0.370)	1 (0.120)	6 (1.060)	0	0	NS	1.5 (0.260)
1996 - 1997	W	NS	NS	NS	NS	NS	0	0	27 (4.930)	17 (2.250)	0	0	NS	7.3 (1.200)
1997 - 1998	W	NS	NS	NS	NS	NS	82 (5.900)	* 36 (35.30)	88 (13.90)	43 (5.430)	7 (0.840)	0	NS	42.7 (10.20)
1998 - 1999	W	NS	NS	NS	NS	NS	83 (13.04)	563 (56.20)	278 (24.90)	363 (17.90)	13 (1.030)	2 (0.230)	NS	217.0 (18.90)

Kodiak and Midwater Trawl at Sacramento

Beginning in 1995 and continuing to the present, two types of gears have been used for trawling near Sacramento; the Kodiak and midwater trawl. Kodiak trawling has normally occurred from mid October through March, and midwater trawling the rest of the year. All trawling was done approximately 5 kilometers (4 miles) downstream of Sacramento to estimate the abundance and timing of juvenile salmon entering the Delta. The same site has been sampled since 1988, except 1990, when sampling was done near the town of Courtland approximately 34 kilometers (21 miles) downstream of the present site. As in the past, 10 twenty minute tows were conducted between three and seven days a week depending on the need to index the relative abundance of juvenile salmon entering the Delta.

At times, the Kodiak and midwater trawls have been used interchangeably between January and March when high flows occur. During these high flow periods when large debris fields were moving down the river, Kodiak trawling was suspended. Changing over to the midwater trawl allowed sampling to continue.

1999 field season

Winter run were first detected in October, the first time they have been captured that early in six years. Peak CPM³ was in November (n = 57) as flows were increasing. The last winter run was captured in April. Size ranges for the Kodiak and midwater trawl were 49-128 mm and 67-133 mm respectively (Figure 14). Peak catch and CPM³ for winter-run and late-fall occurred on November 24, 1998. The monthly peak catch per cubic meter in past years has occurred between February and April (Table 9).

Catches of late-fall run chinook were highest in December (n = 16), and coincided with increasing flows. These were brood year 1998 fish, with size ranges between 87 and 133 mm. Two 1999 brood year chinook were captured in April during receding flows (32 and 36 mm). All but three of the late-fall were taken using the Kodiak trawl (Figure 14). Monthly catch per cubic meter peaks in past years has ranged between October and January (Table 10).

Catches of fall/spring run in the Kodiak trawl were down slightly from 1998 at 5,573, and the highest CPM³ for the season was close to one half of 1998. The reason for the difference in CPM³ was that in during January 1998, conditions did not allow for the completion the standard 10 tows due to very high flow and fog. As in past years, most fall/spring were captured between April and May using the midwater trawl. These fish were captured well after peak flows, and during a period of hatchery releases. A total of 6,975 chinook were captured for the season (Figure 14 and Table 11).

Figure 15 shows an overall decline in the numbers of smolts captured from 1988 through 1999, between April and June each year. A possible reason for this is the wet water years from 1995 through 1999 when higher flows during the winter period could have pushed salmon from the river and into the Delta as fry during the winter rather than smolts during the spring. There also appears to be fewer smolts migrating during June (with the possible exception of 1998) than prior to 1994.

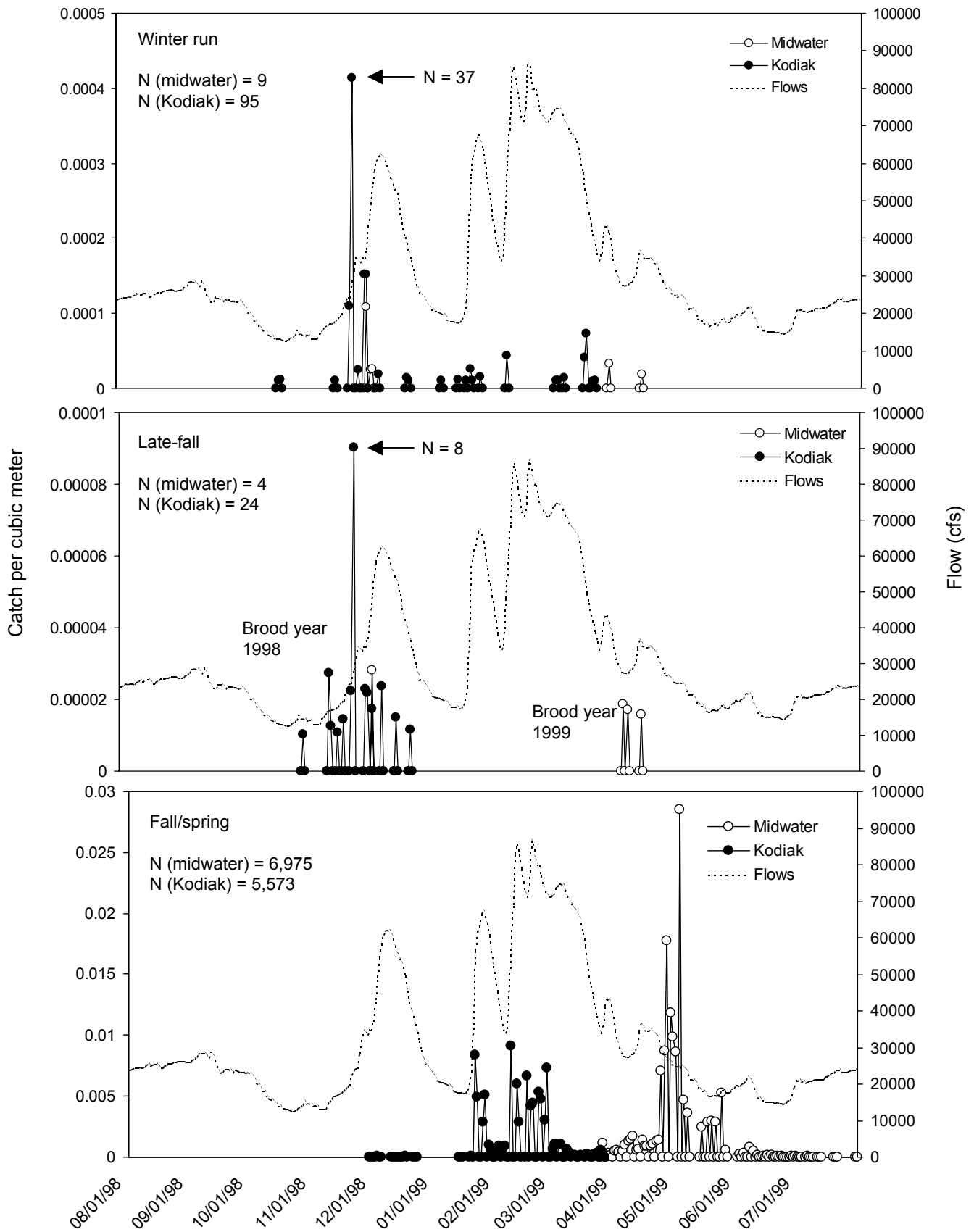

Figure 14. Daily catch per cubic meter in the midwater and Kodiak trawl at Sacramento during the 1999 field season for fall/spring, late-fall, and winter run chinook salmon, and flow at Freeport (cfs).

Table 9. Sacramento River midwater and Kodiak trawl **winter run** raw catch, catch per cubic meter multiplied by 10,000 (in parenthesis), and maximum monthly statistics for each year between 1993 and 1999 field seasons. Peak catch per cubic meter values are highlighted. Water year type (C = critical, D = dry, BN = below normal, AN = above normal, W = wet), average (Aver) catch and CPM³ per year are also shown. NS = Not sampled.

Field season	Water year	Aug	Sep	Oct	Nov	Dec	Jan	Feb	Mar	Apr	May	Jun	Jul	Aver
1992 - 1993 mwtr	AN	NS	0	0	0	4 (0.081)	15 (0.118)	27 (0.210)	153 (0.597)	73 (0.359)	0	0	NS	27.2 (0.137)
1993 - 1994 mwtr	C	NS	0	0	0	0	0	8 (0.084)	2 (0.024)	5 (0.054)	0	0	NS	1.5 (0.161)
1994 - 1995 mwtr	W	NS	0	0	0	0	NS	NS	15 (0.334)	10 (0.281)	0	0	0	1.4 (0.056)
1994 - 1995 kdr	W	NS	NS	NS	NS	1 (0.026)	3 (0.054)	40 (0.292)	35 (0.892)	45 (0.356)	NS	NS	NS	25 (0.324)
1995 - 1996 mwtr	W	0	0	0	NS	NS	NS	NS	NS	2 (0.011)	0	0	0	0.3 (0.002)
1995 - 1996 kdr	W	NS	NS	0	0	61 (0.249)	31 (0.142)	31 (0.170)	120 (0.723)	3 (0.605)	NS	NS	NS	35.1 (0.270)
1996 - 1997 mwtr	W	0	0	0	NS	NS	0	2 (0.041)	0	2 (0.013)	0	0	0	0.4 (0.008)
1996 - 1997 kdr	W	NS	NS	0	2 (0.016)	8 (0.039)	0	13 (0.213)	18 (0.117)	NS	NS	NS	NS	6.8 (0.063)
1997 - 1998 mwtr	W	0	0	0	NS	NS	NS	NS	0	5 (0.082)	0	0	NS	0.7 (0.012)
1997 - 1998 kdr	W	NS	NS	0	10 (0.076)	9 (0.088)	2 (0.015)	3 (0.069)	33 (0.233)	NS	NS	NS	NS	9.3 (0.080)
1998 - 1999 mwtr	W	NS	NS	NS	NS	6 (0.532)	NS	NS	2 (0.082)	3 (0.007)	0	0	0	1.8 (0.104)
1998 - 1999 kdr	W	NS	0	2 (0.011)	57 (0.678)	16 (0.127)	6 (0.063)	3 (0.037)	11 (0.106)	NS	NS	NS	NS	13.6 (0.146)

Table 10. Sacramento River midwater and Kodiak trawl **late-fall run** raw catch, catch per cubic meter multiplied by 10,000 (in parenthesis), and maximum monthly statistics for each year between 1993 and 1999 field seasons. Peak catch per cubic meter values are highlighted. Water year type (C = critical, D = dry, BN = below normal, AN = above normal, W = wet), average (Aver) catch and CPM³ per year are also shown. NS = Not sampled.

Field season	Water year	Aug	Sep	Oct	Nov	Dec	Jan	Feb	Mar	Apr	May	Jun	Jul	Aver
1992 - 1993 mwtr	AN	NS	0	0	43 (0.475)	11 (0.175)	2 (0.017)	1 (0.007)	0	5 (0.024)	0	1 (0.010)	NS	6.3 (0.071)
1993 - 1994 mwtr	C	NS	4 (0.155)	19 (0.207)	1 (0.005)	4 (0.048)	1 (0.010)	2 (0.020)	0	0	0	0	NS	3.1 (0.045)
1994 - 1995 mwtr	W	NS	0	0	1 (0.011)	30 (0.332)	NS	NS	0	0	0	0	1 (0.016)	3.6 (0.040)
1994 - 1995 kdtr	W	NS	NS	NS	NS	2 (0.048)	8 (0.153)	0	0	0	NS	NS	NS	2.0 (0.040)
1995 - 1996 mwtr	W	1 (0.016)	1 (0.013)	0	NS	NS	NS	NS	NS	1 (0.006)	0	0	0	0.4 (0.005)
1995 - 1996 kdtr	W	NS	NS	0	0	17 (0.070)	10 (0.043)	0	0	0	NS	NS	NS	3.9 (0.016)
1996 - 1997 mwtr	W	0	0	0	NS	NS	2 (0.064)	0	0	0	0	0	0	0.2 (0.006)
1996 - 1997 kdtr	W	NS	NS	0	8 (0.045)	8 (0.039)	1 (0.150)	1 (0.016)	0	NS	NS	NS	NS	3.0 (0.041)
1997 - 1998 mwtr	W	5 (0.090)	3 (0.069)	2 (0.078)	NS	NS	NS	NS	0	1 (0.019)	0	1 (0.012)	NS	1.7 (0.038)
1997 - 1998 kdtr	W	NS	NS	0	16 (0.096)	5 (0.044)	0	0	0	NS	NS	NS	NS	3.5 (0.023)
1998 - 1999 mwtr	W	NS	NS	NS	NS	1 (0.094)	NS	NS	0	3 (0.021)	0	0	0	0.7 (0.019)
1998 - 1999 kdtr	W	NS	0	1 (0.007)	16 (0.158)	7 (0.056)	0	0	0	NS	NS	NS	NS	3.4 (0.031)

Table 11. Sacramento River midwater and Kodiak trawling **fall/spring** run raw catch, catch per cubic meter multiplied by 10,000 (in parenthesis), and maximum monthly statistics for each year between 1993 and 1999 field seasons. Peak catch per cubic meter values are highlighted. Water year type (C = critical, D = dry, BN = below normal, AN = above normal, W = wet), average (Aver) catch and CPM³ per year are also shown. NS = Not sampled.

Field season	Water year	Aug	Sep	Oct	Nov	Dec	Jan	Feb	Mar	Apr	May	Jun	Jul	Aver
1992 - 1993 mwtr	AN	NS	1 (0.016)	0	4 (0.040)	22 (0.293)	195 (2.340)	403 (2.479)	515 (2.300)	8,535 (47.85)	10,145 (82.62)	694 (9.330)	NS	2,051.4 (14.73)
1993 - 1994 mwtr	C	NS	1 (0.042)	0	1 (0.007)	4 (0.075)	192 (1.994)	1,036 (10.95)	69 (0.850)	6,588 (109.4)	2,425 (27.45)	73 (1.648)	NS	1,038.9 (15.24)
1994 - 1995 mwtr	W	NS	0	0	0	6 (0.069)	NS	NS	1,020 (23.03)	648 (14.78)	2,312 (13.88)	289 (4.382)	20 (0.261)	477.2 (6.267)
1994 - 1995 kdr	W	NS	NS	NS	NS	0	1,132 (18.88)	1,168 (7.581)	2,324 (58.79)	1,366 (9.675)	NS	NS	NS	1,198 (18.99)
1995 - 1996 mwtr	W	6 (0.073)	0	0	NS	NS	NS	NS	NS	5,767 (44.18)	5,493 (31.52)	62 (2.344)	13 (0.229)	1,620.1 (11.19)
1995 - 1996 kdr	W	NS	NS	0	0	669 (1.900)	7,456 (48.56)	21,044 (191.5)	2,802 (16.85)	2,111 (51.24)	NS	NS	NS	6,816.4 (168.2)
1996 - 1997 mwtr	W	0	1 (0.013)	0	NS	NS	46 (1.726)	47 (0.935)	9 (1.674)	5,886 (51.84)	1,451 (13.56)	59 (0.881)	30 (0.576)	752.9 (7.121)
1996 - 1997 kdr	W	NS	NS	0	2 (0.014)	191 (1.599)	117 (20.36)	242 (4.180)	407 (2.711)	NS	NS	NS	NS	159.8 (4.811)
1997 - 1998 mwtr	W	10 (0.161)	1 (0.019)	0	NS	NS	NS	NS	22 (7.347)	1,734 (25.49)	1,061 (15.53)	671 (7.780)	NS	499.9 (8.047)
1997 - 1998 kdr	W	NS	NS	0	2 (0.012)	37 (0.274)	3,211 (89.64)	1,530 (53.79)	1,260 (12.73)	NS	NS	NS	NS	1,006.7 (26.09)
1998 - 1999 mwtr	W	NS	NS	NS	NS	0	NS	NS	39 (6.927)	3,599 (33.95)	3,187 (58.39)	140 (2.015)	10 (0.153)	1,395 (20.29)
1998 - 1999 kdr	W	NS	0	0	1 (0.009)	12 (0.131)	1,755 (14.02)	3,248 (42.53)	557 (4.571)	NS	NS	NS	NS	1,114.6 (12.25)

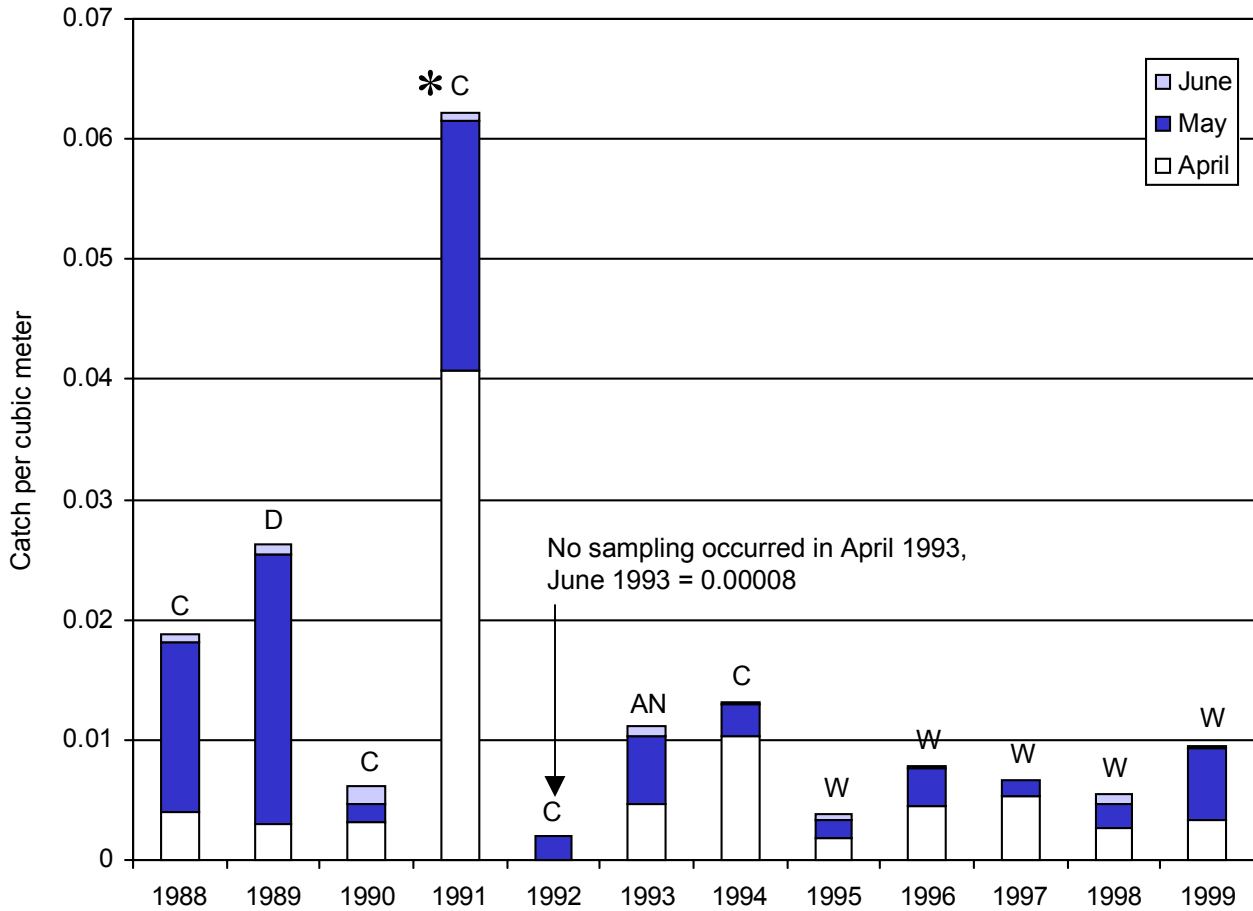

Figure 15. Sacramento trawl catch per cubic meter of all unmarked juvenile chinook between 1988 and 1999, for April, May, and June. * = Due to high catches on April 29, May 1 and May 3, 10 minute tows were conducted most of each sample day. Each 10 minute tow was then standardized to 20 minutes, doubling the catch for each tow. W = wet year, AN = above normal year, D = dry year, and C = critical year.

Kodiak Trawl at Mossdale

Trawling at Mossdale began on September 4, 1996, to index juvenile salmon moving into the Delta from the San Joaquin basin. As stated in the lower San Joaquin River beach seine section, all San Joaquin River chinook have been classified as fall run.

1999 field season

1999 was the first year when flows were high enough to conduct sampling at Mossdale from November through June. Juveniles were first detected entering the Delta in January, and continued to be captured until sampling ended for the season in June. During the previous two seasons when sampling did not occur during the January - February period due to low flows, peak CPM³ occurred during May, after hatchery releases. In 1999 peak monthly CPM³ occurred during February. Highest daily CPM³ occurred on February 10, 1999 at the beginning of a spike in flows (Figure 16 and Table 12).

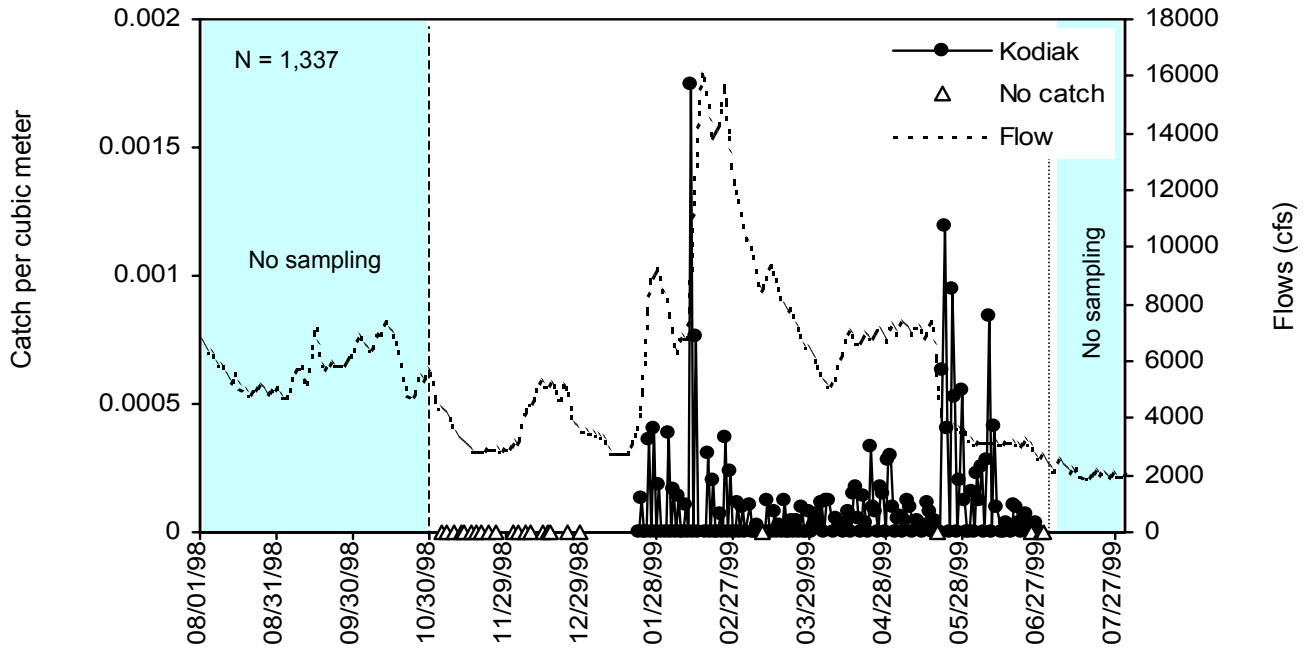

Figure 16. Daily catch per cubic meter in the Kodiak trawl at Mossdale during the 1999 field season for San Joaquin River Basin fall run chinook salmon. Flow information was taken at Vernalis.

Table 12. Mossdale Kodiak trawl **fall run** raw catch, catch per cubic meter multiplied by 10,000 (in parenthesis), and maximum monthly statistics for each year between 1997 and 1999 field seasons. Peak means are highlighted. An average of the monthly means for all years is included in the last row of the table. Prior to 1997, sampling at Mossdale occurred between April and June, conducted by DFG, Region 4. NS = Not sampled.

Field season	Water year	Aug	Sep	Oct	Nov	Dec	Jan	Feb	Mar	Apr	May	Jun	Jul	Aver
1996 - 1997	W	NS	0	0	0	0	NS	NS	30 (0.720)	800 (2.920)	656 (4.020)	110 (1.190)	NS	399 (1.200)
1997 - 1998	W	NS	NS	NS	NS	NS	NS	NS	NS	504 (2.210)	1,261 (3.120)	549 (0.490)	NS	771.3 (1.940)
1998 - 1999	W	NS	NS	NS	0	0	81 (0.960)	319 (3.94)	84 (0.680)	264 (1.190)	406 (2.300)	183 (1.380)	NS	167.1 (1.310)

Midwater Trawling at Chipps Island

Trawling at Chipps Island was conducted to gain information about juvenile salmon emigrating from the Delta. Ten 20 minute tows were conducted between three and seven days a week depending on the need to recover coded wire tagged salmon for survival studies. A doubling of effort was conducted between April 22 and May 22. During this period of sampling, 20 twenty minute tows were conducted each day, seven days per week to increase recovery of CWT smolts.

1999 field season

Winter run catches in 1999 were greater than in 1998, however average CPM³ was lower than in 1992-1993, 1994-1995 and 1995-1996. Peak catch per cubic meter was in march as in most past years (Table 13). Size ranges were between 67 and 162 mm, and catches occurred from December 1, 1998 to April 29, 1999. Winter run were first detected during the first high flow event, and continued to be sampled throughout the high flow period, with peak CPM³ occurring as flows were receding (Figure 17).

Late-fall catches were up slightly from 1998, with average CPM³ higher than any of the years shown in Table 14. Of the 96 late-fall captured, 95 were from BY 1998 with sizes ranging between 73 and 193 mm. These smolts/yearlings were captured between September 2, 1998, and February 10, 1999 with the majority emigrating during the first peak outflows of the season. Only one BY 1999 fry was captured on July 7, 1999 at 56 mm. (Figure 17).

A total of 14,204 fall/spring were captured for the 1998-1999 season. Average CPM³ was nearly one half the CPM³ in 1998, and ranked sixth of the seven years shown in Table 15. Yearling size smolts were captured between September 2 and October 14, with size ranges from 93 to 265 mm. Most of these chinook were taken well after peak outflow (Figure 17).

Overall, as in past years, most of the smolts in 1999 migrated through the Delta in April and May, reflecting the high numbers of fall/spring run chinook, and the influence of hatchery releases from Coleman National Fish Hatchery. The mean juvenile chinook abundance in 1999 for April, May, and June was twice as high as 1997, but only one half as large as in 1998, or a third of 1983, the historic year of greatest abundance (Figure 18).

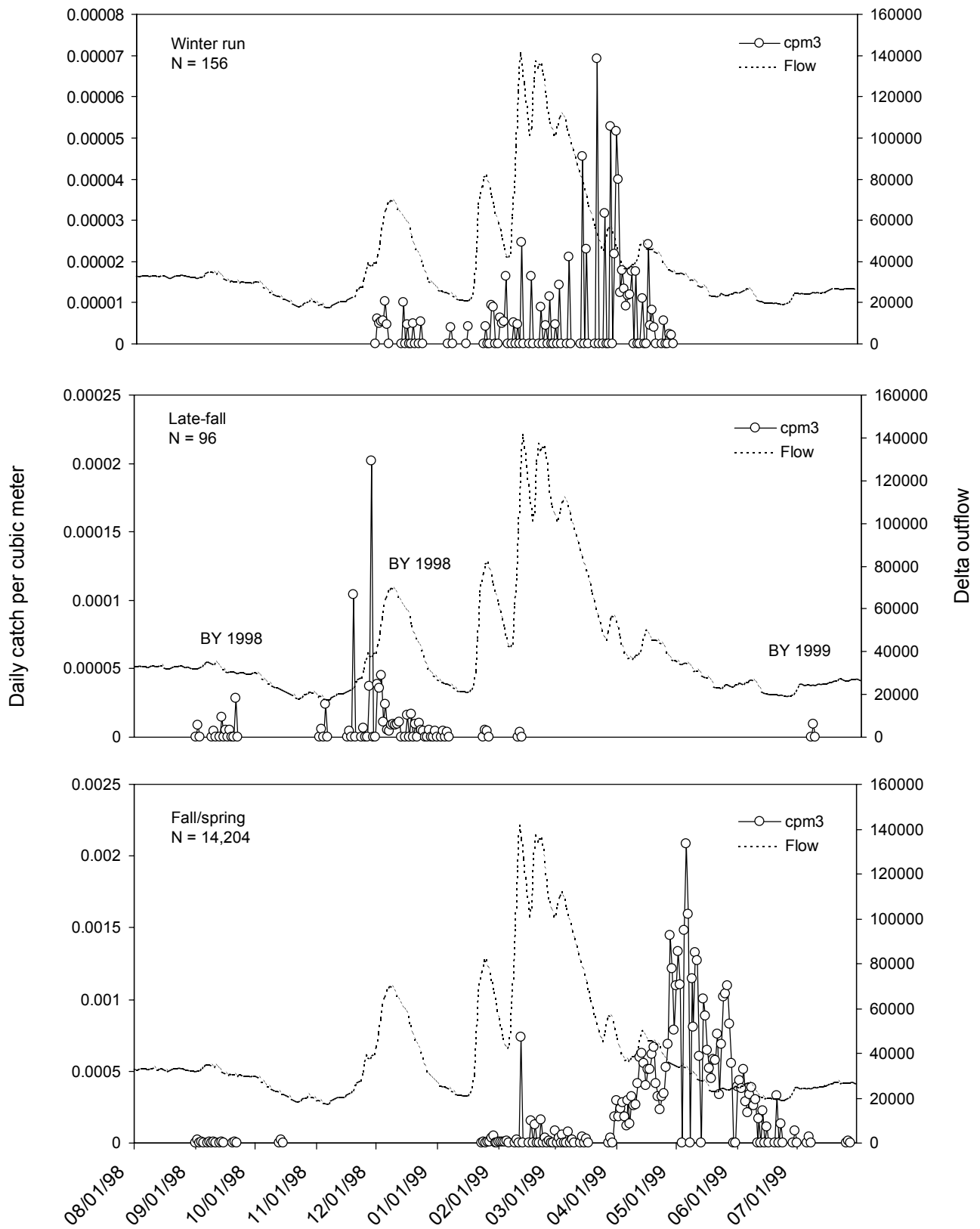

Figure 17. Daily catch per cubic meter in the Chipps Island midwater trawl during the 1999 field season for fall/spring, late-fall, and winter run chinook salmon, and Delta outflow.

Table 13.

Chippis Island midwater trawl **winter run** raw catch, catch per cubic meter X's 10,000 (in parenthesis), and maximum monthly statistics for each year between 1993 and 1999 field seasons. Peak catch per cubic meter values are highlighted. Water year type (C = critical, D = dry, BN = below normal, AN = above normal, W = wet), average (Aver) catch and CPM³ per year are also shown. NS = Not sampled.

Field season	Water year	Aug	Sep	Oct	Nov	Dec	Jan	Feb	Mar	Apr	May	Jun	Jul	Aver
1992 - 1993	AN	NS	NS	NS	NS	NS	NS	NS	NS	223 (0.330)	2 (0.002)	0	0	56.3 (0.083)
1993 - 1994	C	NS	NS	NS	0	0	1 (0.003)	2 (0.011)	29 (0.083)	14 (0.021)	1 (0.001)	0	NS	8.0 (0.013)
1994 - 1995	W	NS	NS	0	0	0	10 (0.012)	38 (0.325)	109 (0.437)	151 (0.332)	4 (0.004)	0	0	31.2 (0.111)
1995 - 1996	W	0	0	0	0	4 (0.064)	38 (0.066)	33 (0.112)	239 (0.595)	39 (0.086)	3 (0.001)	0	0	29.7 (0.077)
1996 - 1997	W	0	NS	0	0	1 (0.009)	11 (0.017)	33 (0.082)	72 (0.253)	44 (0.129)	2 (0.003)	0	0	14.8 (0.045)
1997 - 1998	W	0	0	0	0	6 (0.010)	17 (0.026)	4 (0.018)	54 (0.217)	29 (0.062)	2 (0.003)	0	NS	10.2 (0.031)
1998 - 1999	W	NS	0	0	0	12 (0.020)	7 (0.012)	18 (0.086)	64 (0.278)	55 (0.102)	0	0	0	14.2 (0.045)

Table 14.

Chippis Island midwater trawl **late-fall run** raw catch, catch per cubic meter X's 10,000 (in parenthesis), and maximum monthly statistics for each year between 1993 and 1999 field seasons. Peak catch per cubic meter values are highlighted. Water year type (C = critical, D = dry, BN = below normal, AN = above normal, W = wet), average (Aver) catch and CPM³ per year are also shown. NS = Not sampled.

Field season	Water year	Aug	Sep	Oct	Nov	Dec	Jan	Feb	Mar	Apr	May	Jun	Jul	Aver
1992 - 1993	AN	NS	NS	NS	NS	NS	NS	NS	NS	0	0	0	0	0
1993 - 1994	C	NS	NS	NS	8 (0.030)	53 (0.079)	2 (0.005)	5 (0.013)	0	0	0	0	NS	8.5 (0.016)
1994 - 1995	W	NS	NS	0	9 (0.023)	49 (0.073)	34 (0.040)	0	0	0	1 (0.001)	0	0	8.9 (0.014)
1995 - 1996	W	0	1 (0.006)	1 (0.015)	0	10 (0.184)	20 (0.039)	1 (0.002)	0	0	1 (0.005)	0	0	2.8 (0.021)
1996 - 1997	W	0	NS	0	0	74 (0.112)	12 (0.022)	0	0	0	0	0	0	7.8 (0.012)
1997 - 1998	W	5 (0.015)	6 (0.051)	6 (0.020)	5 (0.031)	49 (0.083)	12 (0.011)	0	0	0	0	0	NS	7.5 (0.019)
1998 - 1999	W	NS	12 (0.058)	0	25 (0.381)	53 (0.091)	4 (0.008)	1 (0.003)	0	0	0	0	1 (0.012)	8.7 (0.049)

Table 15. Chippis Island midwater trawl **fall/spring run** raw catch, catch per cubic meter X's 10,000 (in parenthesis), and maximum monthly statistics for each year between 1993 and 1999 field seasons. Peak catch per cubic meter values are highlighted. Water year type (C = critical, D = dry, BN = below normal, AN = above normal, W = wet), average (Aver) catch and CPM³ per year are also shown. NS = Not sampled.

Field season	Water year	Aug	Sep	Oct	Nov	Dec	Jan	Feb	Mar	Apr	May	Jun	Jul	Aver
1992 - 1993	AN	NS	NS	NS	NS	NS	NS	NS	NS	4,909 (7.380)	9,934 (11.04)	2,580 (4.210)	48 (0.624)	4,367.8 (5.814)
1993 - 1994	C	NS	NS	NS	11 (0.331)	0	0	1 (0.003)	5 (0.017)	3,713 (4.439)	2,094 (3.740)	102 (0.195)	NS	740.8 (4.293)
1994 - 1995	W	NS	NS	15 (0.057)	9 (0.036)	0	457 (0.572)	125 (0.407)	262 (1.134)	4,179 (7.779)	11,423 (15.39)	3,178 (4.850)	100 (0.345)	1,975 (3.057)
1995 - 1996	W	14 (0.032)	8 (0.068)	15 (0.193)	1 (0.013)	2 (0.031)	59 (0.100)	1,578 (3.661)	688 (1.590)	4,233 (9.356)	10,195 (13.58)	339 (1.580)	0	1,428 (2.510)
1996 - 1997	W	2 (0.141)	NS	0	1 (0.011)	7 (0.017)	31 (0.817)	2 (0.004)	27 (0.123)	2,351 (3.912)	1,323 (2.358)	187 (0.358)	26 (0.103)	359.6 (0.713)
1997 - 1998	W	10 (0.047)	3 (0.013)	1 (0.003)	0	1 (0.002)	209 (0.336)	138 (0.678)	568 (2.735)	10,929 (10.71)	20,377 (16.28)	1,711 (3.62)	NS	3,086 (3.168)
1998 - 1999	W	NS	10 (0.053)	4 (0.028)	0	0	22 (0.041)	194 (1.171)	124 (0.207)	3,828 (4.676)	9,153 (9.923)	866 (2.211)	3 (0.127)	1,291 (1.703)

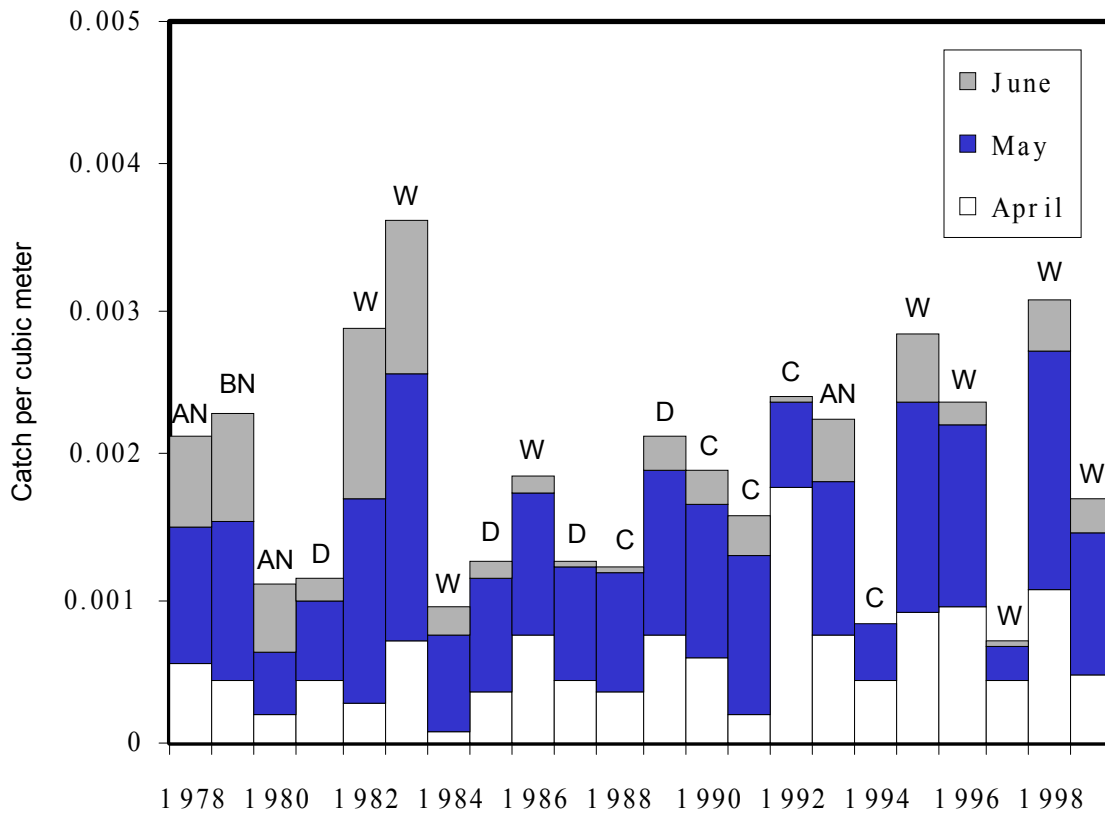

Figure 18. Catch per cubic meter of all races of salmon in the midwater trawl during April, May, and June at Chipps Island for the years 1978 - 1999. W = wet year, AN = above normal year, D = dry year, and C = critical year.

Bay Seine

On January 28, 1997, using historical seine sites from the 1980's, the office began revisiting sites in the Bay, to determine if fry were present in the San Francisco Bay. Seining was conducted between January and March. Ten seine sites were separated into two seine routes of five sites sampled per week.

1999 field season

Sampling was conducted from November 5, 1998, through July 28, 1999. During this period CPM³ was low. Of the 11 juveniles, 10 of the fry ranged from 30 to 66 mm. Unlike previous years, one 105 mm smolt was captured at McNear's Beach on May 26, 1999 (Figure 19).

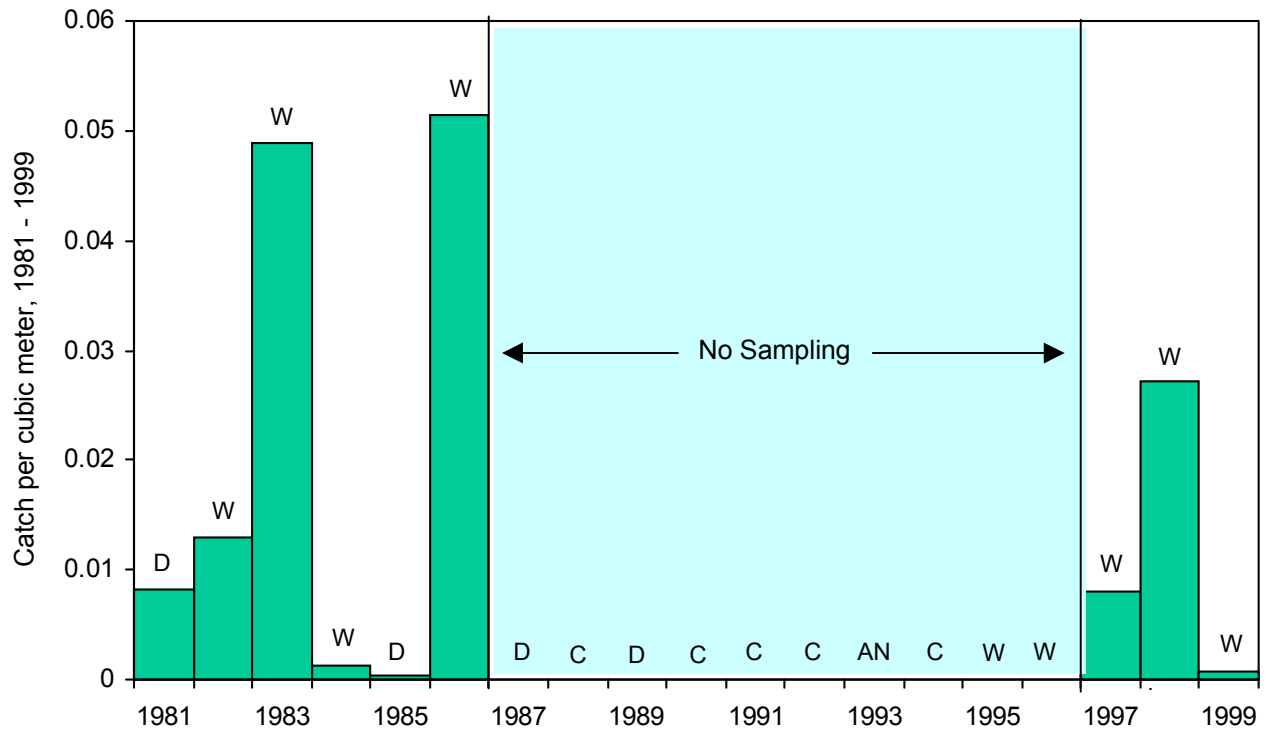

Figure 19. Mean yearly catch per cubic meter for all chinook salmon races, from 1981 through 1999. The water year type is included for each year (W=wet, AN=above normal, BN=below normal, D=dry, and C=critical).

Absolute Abundance Estimates

To estimate the absolute abundance of each of the various races of juvenile salmon passing Chipps Island, we used the mean yearly trawl recovery rate to expand catches. Each years mean trawl recovery rate is the average of the trawl recovery rates of all tag groups within a year.

The trawl recovery rate at Chipps Island was calculated based on the following formulas:

Trawl recovery rate = # captured at Chipps / # available for capture at Chipps, adjusted for time,
the # captured = the number of a particular tag code recovered at Chipps Island,
the # available for capture at Chipps adjusted for time = # surviving X fraction of time sampled,
the # surviving to Chipps Island = recovery rate in the ocean fishery of the upstream tag group /
recovery rate in the ocean fishery of the control group (Benicia, Port Chicago, or Ryde),
and the recovery rate in the ocean fishery = expanded # of a of a particular tag code recovered in
ocean fishery/number released

The mean yearly recovery rate between 1980 and 1999 (excluding 1987) ranged from 0.0034 to 0.0329 and averaged 0.0102 (Figure 20). No control releases were made during 1987 thus no estimate of trawl recovery rate was obtained for that year. The mean recovery rates for years 1980 to 1996 (excluding 1987) were used as recovery rates during 1978, 1979, and 1987 due to a lack of control releases and/or data availability.

If the control groups (Port Chicago or Benicia) had unusually low ocean survival rates the resulting trawl recovery estimate would be greater than 1.0. To prevent this, Ryde which is approximately 25 miles upstream was used at times as a control group.

Groups with survival greater than 1.0 were not used in the calculation of trawl recovery rates because they were outside the boundaries of reasonable estimates. Survival values equal to 0.0 were not used as well, because recovery rates could not be estimated using null values. Although there were many assumptions associated with these estimates of trawl recovery, they do provide an assessment of trawl recovery at Chipps Island.

Past expansions using the fraction of time and channel width sampled of coded wire tagged fish recovered at Chipps Island have estimated survival to be greater than 1.0 at times. This may indicate that, due to the tidal flux at Chipps Island, the same group of fish were sampled repeatedly (fish may be moving past Chipps Island more than once due to tidal effect). This would over estimate survival. Sampling was also done during the day which typically yields higher catches than at night (Wickwire and Stevens, 1966) which would also bias the survival estimates high. It was assumed for these estimates of trawl recovery rates that the coded wire tagged smolts passing by Chipps Island were equally distributed in both time and space (across the channel).

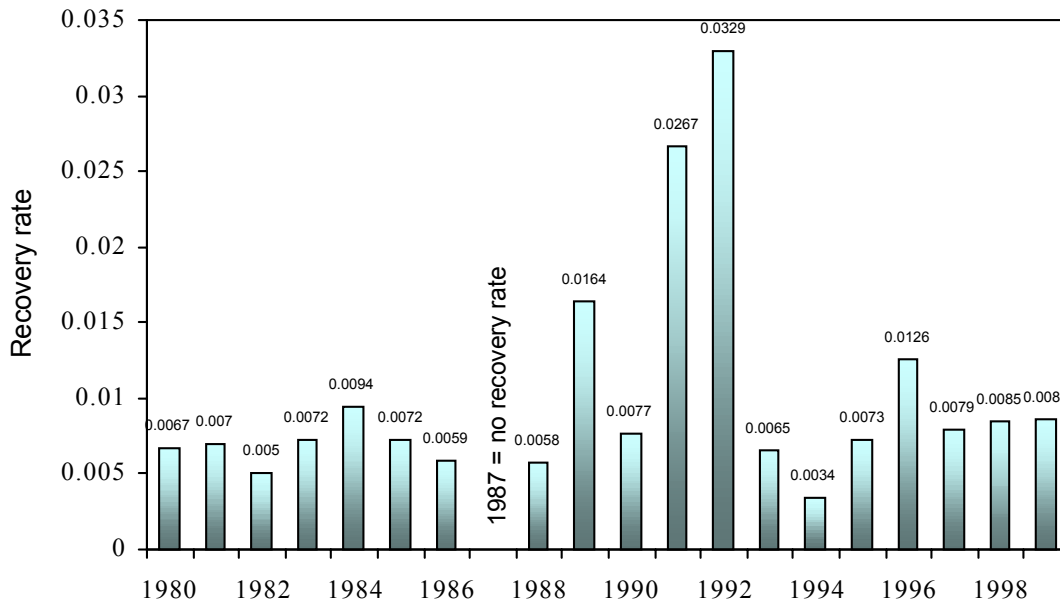

Figure 20. Recovery rate of the midwater trawl at Chipps Island between 1980 and 1999 (excluding 1987)

Absolute abundance for each of the races was estimated using the mean trawl recovery rate to expand juvenile catch at Chipps Island between 1993-1994 and 1998-1999.

The juvenile winter run estimate was 262,137 during 1999. This is less than the peaks observed in 1995 and 1996, but greater than that observed in 1998 (Table 15).

A total of 88 late-fall yearlings were captured at Chipps Island between September 1998 and February 1999 (the 1999 field season) representing the 1998 brood stock. No fry from this brood year were caught during the summer of 1998. One 1999 brood year late-fall fry was captured during the 1999 field season (Table 15).

Juvenile fall/spring run chinook estimates for the season shown in Table 15, consist of fry captures during the winter, and smolt captures during the spring (between August 1, 1998 and July 31, 1999). Estimates during 1999 were the second lowest from 1994 through 1999. Only the 1997 estimates were lower than 1999.

Table 15. Fall/spring, winter, and late-fall run chinook abundance estimates between 1993-1994 (1994) and 1998-1999 (1999).

Year/race	Catch	Trawl Recovery Rate	Estimated Abundance
1994 Fall/spring	5,926	0.0034	14,835,287
1995 Fall/spring	19,748	0.0073	23,406,563
1996 Fall/spring	17,132	0.0126	9,282,405
1997 Fall/spring	3,957	0.0079	9,263,602
1998 Fall/spring	33,947	0.0085	21,777,960
1999 Fall/spring	12,485	.00086	9,513,315
1994 Winter	47	0.0034	201,613
1995 Winter	312	0.0073	640,174
1996 Winter	356	0.0126	470,228
1997 Winter	163	0.0079	306,391
1998 Winter	112	0.0085	190,136
1999 Winter	157	0.0086	262,137
1994 Brood Year Late-fall	0 (fry) 97 (yearling)	0.0034 0.0073	0 174,848
1995 Brood Year Late-fall	1 (fry) 33 (yearling)	0.0073 0.0126	589 <u>22,654</u> 23,017
1996 Brood Year Late-fall	1 (fry) 86 (yearling)	0.0126 0.0079	596 <u>117,721</u> 118,317
1997 Brood Year Late-fall	0 (fry) 83 (yearling)	0.0079 0.0085	0 122,465
1998 Brood Year Late-fall	0 (fry) 88 (yearling)	0.0085 0.0086	0 147,434
1999 Brood Year Late-fall*	1 (fry)	0.0086	17,899

* = this estimate only includes fry captures during the 1999 field season.

Figure 21 graphs yearly abundance estimates at Chipps Island between April 1 and June 30 from 1978 to 1999 using the trawl recovery rate for each year and if not available, the mean from 1980 to 1999 (excluding 1987). This graph provides a general index of the absolute production of chinook passing Chipps Island between April and June from 1978 to 1998.

As discussed previously, catch per cubic meter at Chipps Island of smolts between April and June is significantly correlated with mean flow at Rio Vista (cfs) between 1978 and 1999 (Figure 22). This relationship shows that salmon smolt density increases during higher outflow.

If the mean density of smolts captured between April and June is divided by the trawl recovery rate for each year and plotted with flow, the relationship is improved (Figure 23), indicating that trawl recovery rates likely vary between years. Correcting for these differences in recovery rates improves the observed relationship and validates the use of this methodology.

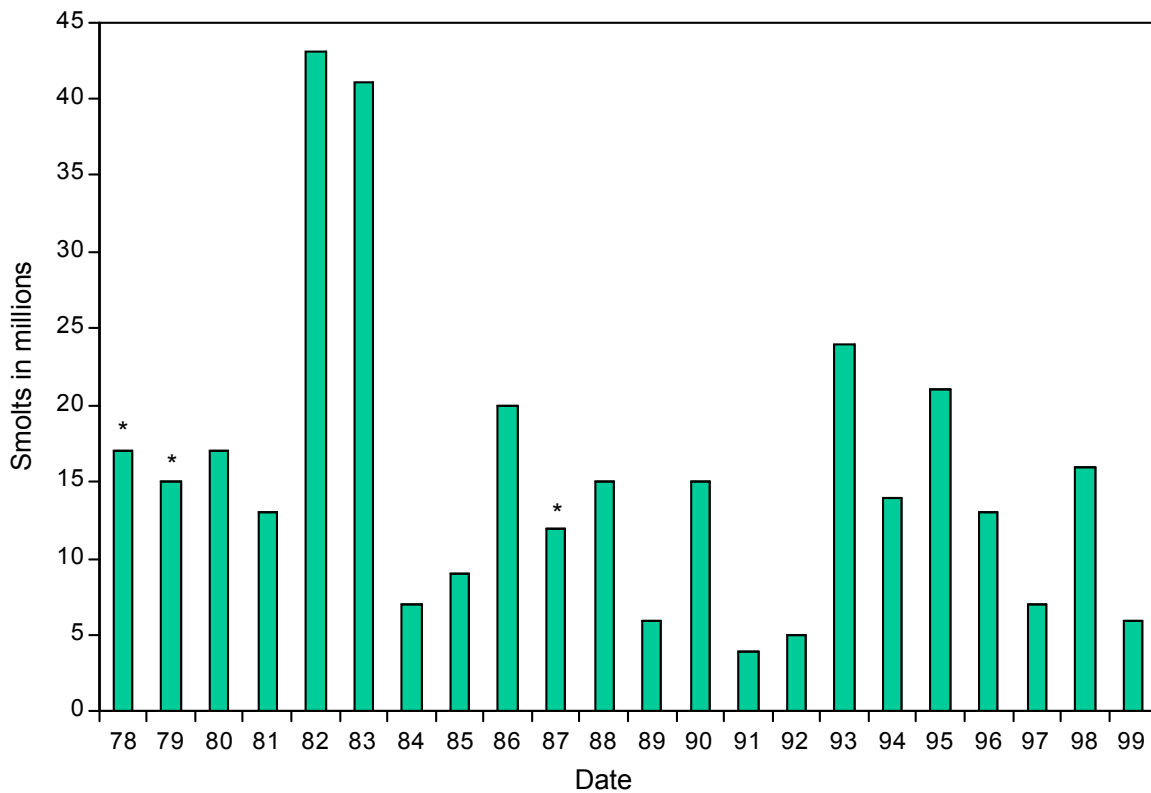

Figure 21. Absolute estimates of smolt abundance at Chipps Island between April 1 and June 30 from 1978 to 1999 using trawl recovery rates calculated from ocean recoveries. * = used mean trawl recovery between 1980 and 1996 (excluding 1987)

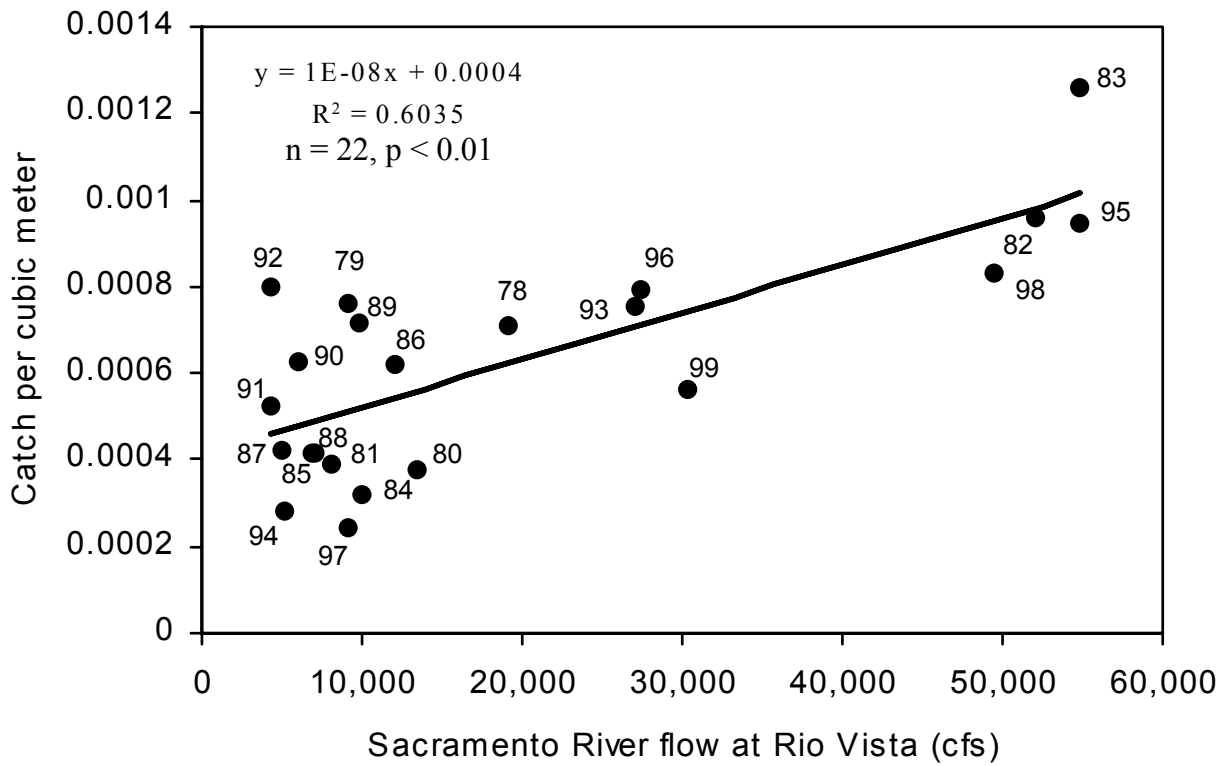

Figure 22. Mean catch of unmarked chinook salmon smolts per cubic meter in the midwater trawl at Chipps Island between April and June of 1978 to 1999 versus mean daily Sacramento River flow at Rio Vista between April and June in cfs.

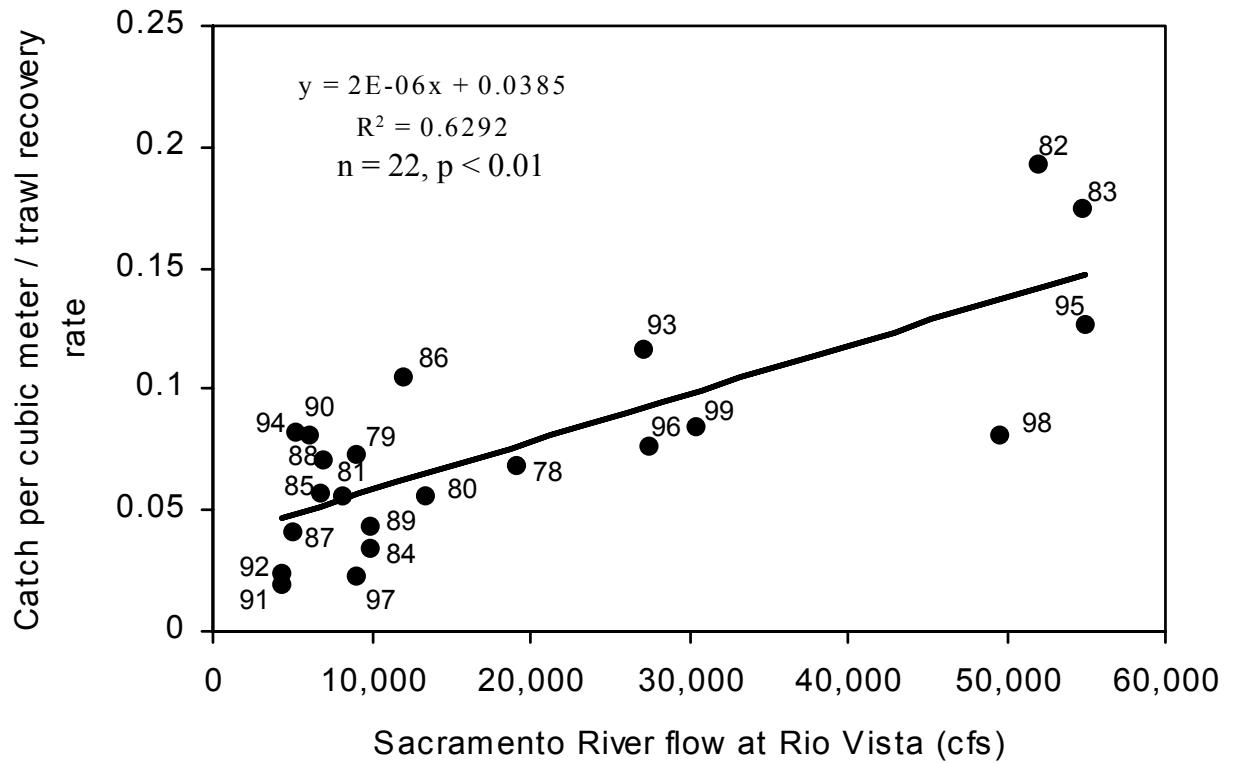

Figure 23. Catch of unmarked smolts per cubic meter at Chipps Island divided by the recovery rate based on CWT studies versus mean daily flow at Rio Vista (April-June) in cfs, from 1978 to 1999. Mean recovery rates for years 1980 to 1996 (excluding 1987) were used as recovery rate during 1978, 1979, 1987 due to lack of control releases and or data availability.

1999 Mark and Recapture Studies

Introduction

Three separate mark and recapture experiments were conducted in 1999 to better understand juvenile chinook salmon survival through the Sacramento/San Joaquin Delta. They were the : Delta Action 8 experiment , the Sacramento River Fall-Run Survival Indexing experiment and the Vernalis Adaptive Management Plan (Vamp) experiment.

The Delta Action 8 experiment utilizes late-fall run yearlings from Coleman National Fish Hatchery to help assess how juvenile salmon survive in the interior Delta relative to the mainstem Sacramento River, and how that relative interior Delta survival is related to exports.

The Sacramento River Fall Run Survival experiment indexes the survival of juvenile chinook salmon as they migrate through the Delta from Sacramento River to Chipps Island. Three groups of hatchery fish from Feather River were released between April 15 and May 15 in 1999 under various environmental conditions. The indices are compared to similar indices generated in previous years. This serves as an indicator of survival through the Delta for naturally spawned fall run smolts. It also provides estimates of baseline survival to help evaluate Delta restoration and operational changes that may occur in the future.

VAMP releases are designed to evaluate the role of river flows and State Water Project (SWP) and Central Valley Project (CVP) exports on juvenile Chinook salmon survival through the San Joaquin River Delta. VAMP measures survival under specific flow and export targets and includes a barrier at the head of Old River. San Joaquin River flow at Vernalis was approximately 7000 cfs during these experiments in 1999. Exports were approximately 3500 cfs. The head of Old River barrier was not installed in 1999 because access to the site was not granted by the landowner.

Methods

Capture of all marked groups of juvenile chinook salmon was accomplished utilizing the mid-water trawl at Chipps Island, located near Pittsburg, California. This site was chosen for marked fish recovery since all emigrating juveniles need to pass Chipps island on their way to the ocean. While this area is a relatively narrow constriction of the confluence of the river, it still measures approximately 3900 feet. The trawling methods were described earlier in this document under the methods for trawling section. Coded wire tag (CWT) juvenile chinook salmon are marked externally with an adipose fin clip. If a fin clip is observed, the juvenile chinook salmon were collected and returned to the laboratory for processing at the end of the sampling day. Each marked group has a unique coded wire tag code. The CWT is dissected from the salmon and read under the microscope. Tags are read twice with any discrepancies resolved by a third reader.

Survival to Chipps Island was calculated using the following equation:

$$S = \# \text{ fish recovered} / ((\# \text{ fish released}) * (\text{Fraction of time sampled}) * (\text{percent of channel sampled}))$$

Relative survival is the ratio of one survival index divided by another. In the case of the relative survival in the interior Delta the Georgiana Slough survival index to Chipps Island is divided by the Ryde index.

Sampling in 1999 was also conducted in April and May on the lower San Joaquin River at Jersey Point by Chuck Hanson, a consultant as part of the VAMP studies. Those recoveries will also be

reported. Survival indices to Jersey Point were generated from the recoveries of smolts released as part of the VAMP studies similar to the methodology used to index survival to Chipps Island. Recoveries at Jersey Point from marked fish released on the mainstem Sacramento River are informative but are not used to index survival since many fish released on the Sacramento River would not be caught in the lower San Joaquin River. In contrast, Chipps Island is located at the confluence of the Sacramento and San Joaquin Rivers and would catch marked fish released in either river.

Marked fish are also recovered in the south Delta at the fish facilities and in other sampling conducted by this office. These will also be reported.

Delta Action 8 Experiments

In 1992, an experiment to determine relative juvenile chinook salmon survival in the interior Sacramento/San Joaquin Delta was initiated. The study looked at differences in survival rates between fish released in the interior Delta and those released in the mainstem Sacramento River. The ratio of survival between the two groups is a measure of relative interior delta survival. This relative interior Delta survival was hypothesized to increase as Central Valley Project (CVP) and State Water Project (SWP) exports decrease. These experiments started using fall run smolts from Feather River Hatchery, and were generally conducted in April and May.

In 1993, the experiment was broadened to include juvenile salmon survival in the winter season. These experiments used late fall run chinook salmon from Coleman National Fish Hatchery. It was believed that late-fall run chinook were better surrogates for winter run, based on their larger size and the timing of their outmigration. Late fall run chinook salmon migrate from November through January during which time water temperatures are cooler than during the spring months. Initially, two sets were to be released. One set under high export conditions and one during a low export condition. During certain years, it was not possible to meet the experimental criteria.

Methods

In 1999, four groups of Coleman NFH late-fall chinook were released at two locations on the Sacramento River. Two groups were released on December 1 and December 29 at Georgiana Slough and two groups were released at Ryde on December 2 and December 30. An additional group was released on December 22 at Port Chicago. Releases at Port Chicago were made to estimate survival in the delta using ocean recoveries. The Port Chicago group is used to factor out survival downstream of that location. The Delta cross channel gates were closed throughout the releases. The gates were not reopened until the end of May. Recoveries were made at Chipps Island and at the state and federal salvage facilities. Ocean recoveries will be made in future years.

Results

Survival indices for late-fall run chinook used in these experiments were substantially higher for fish which utilized the mainstem Sacramento River (Ryde 0.74 and 0.37) versus fish which utilized the central Delta (Georgiana Slough 0.18 and 0.27) as their outmigration pathway (Table 16). As in past years, the data from this years experiments seems to support the hypothesis that chinook salmon experience lower survival when released into the central Delta, even when released in the winter when water temperatures are lower during the time of their migration. However, the December 30 release at Ryde had a low survival index. It isn't clear why this second Ryde group survived at such a low rate.

The Delta Cross Channel gates were closed beginning on September 9 and remained closed during the rest of the fall, winter and spring due to high flows in the lower Sacramento River at

Freeport (<25,000 cfs). Exports were low, between 2000 and 2400 cfs and similar for both groups during the 10 to 14 days after release. Flows on the Sacramento River however were lower for the second group (20,000 cfs versus 55,000 cfs for the first group).

Table 16. Survival indices and expanded SWP and CVP salvage numbers for late fall run releases made in the Sacramento / San Joaquin River Delta in 1998-1999 Field year.

Release Date	Release Site	Number Released	Average FL of Fish (mm)	River Temp. (°F)	Truck Temp. (°F)	Survival Index	Survival Ratio	Expanded SWP Salvage	Expanded CVP Salvage
12/01/98	Georgiana Slough	69180	120	53	56	0.180	0.24	12	16
12/02/98	Ryde	48207	120	52	56	0.741		0	0
12/22/98	Port	45195	120	48	44	**		0	0
12/29/98	Georgiana Slough	68843	119	46	48	0.269	0.72	24	24
12/30/98	Ryde	48804	120	48	50	0.374		0	0

When evaluating this data it is important to compare relative Georgiana Slough survival to Ryde survival. It is our hypothesis that Georgiana Slough survival relative to that at Ryde increases as exports decrease. The ratio of survival of the Georgiana Slough / Ryde group was 0.24 and 0.72 for the first and second groups respectively.

The average Delta inflow for the month of December varied between 27,261cfs (December 31) and 69997cfs (December 8), with an average inflow of 50,709 cfs. Total Exports for December varied from 1148 cfs (December 22) to 3,867 cfs (December 16) with an average export of 2,358 cfs. Actual E/I ratios calculated during the late-fall experiments varied from 2% to 9% average 3% for the December 1 release and from 2% to 33% average 11% for the December 29 release. The ratio of survival was higher when flows were higher and exports were lower and the E/I average ratio was lower.

Sacramento River Fall-Run Survival Index

Since 1978, marked fish have been released near Sacramento and recovered at Chipps Island to index survival through the Delta. These indices can be used to evaluate survival through the Delta annually and over-time. Releases in 1999 were conducted to continue this monitoring of fall run survival through the Delta (Table 17). These indices of survival allow comparisons pre and post 1994 CALFED Bay Delta Accord agreement. Other objectives for the study were to obtain smolt survival indices through the Delta (Sacramento to Chipps Island), to use in improving chinook smolt survival models for the Delta and for assessing future water management or restoration actions in the Delta

Methods

In 1999, three sets of CWT fish from Feather River Fish Hatchery were released from the Broderick boat ramp in West Sacramento. These releases are conducted to estimate survival over the peak period of outmigration of natural fall run chinook salmon. The releases occurred on April 15, April 30 and May 14. An additional group was released at Port Chicago (Concord Naval Weapons Station) to estimate survival from Sacramento to Port Chicago, utilizing ocean recoveries. The Port Chicago release was made on April 26.

Delta Cross Channel gates were closed for the entire period coded wire tags from these release groups were recovered at Chipps Island. Gates reopened on May 28, 1999. Combined CVP/SWP exports averaged 4300 for the months of April and May.

Results

The survival index of the first release group was 0.73, which was the highest of the three groups. The index for the second release was lower at 0.42. The last release had the lowest survival index of 0.22. These differences in survival may be attributable to the increasing river temperatures (55 vs. 64) during each consecutive release.

Table 17. Survival indices and expanded SWP and CVP salvage numbers for fall run releases made in the Sacramento / San Joaquin River Delta in 1999.

Release Date	Release Site	Number Released	Average FL (mm)	Truck Temp. (°F)	River Temp. (°F)	Survival Index	Expanded SWP Salvage	Expanded CVP Salvage
04/15/99	West Sacramento	51,795	82	59	55	0.73	0	0
04/30/99	West Sacramento	51,672	82	55	61	0.42	0	12
05/14/99	West Sacramento	51,218	87	54	64	0.22	0	21
04/26/99	Port Chicago	51,094	89	54	62	N/A	0	0

Previous releases since 1988 have yielded survival indexes ranging from 0.0 in 1994, to the value of 1.1 in 1996 (Table 18). Survival within a season can also be quite variable and ranged between 0.65 to 0.08 in 1988. Survival in 1999 was generally above average.

Survival indices for those years which are either above normal or wet are relatively high early in the study period, but decrease later in the spring. Even in wet and above normal years, river flows likely decrease through-out the study period and could affect the decrease in survival through the month period. One additional explanation may be that as river temperatures increase, salmon are more susceptible to stress and predation. Stress decreases the immune system and exposes the fish to diseases. Also, higher water temperatures cause salmon to become lethargic which may make them more susceptible to predation. River temperatures increased for each consecutive release in 1999 (Table 18).

One additional consideration is the difference in water temperatures the experimental fish are exposed to at the hatchery and at release in these experiments. Exposing hatchery-reared fish to differences in water temperature between the hatchery truck and river, sometimes as much as 22 degrees, may result in increased stress levels due to the shock of such a dramatic temperature change over a very short period of time

The temperature differences between the truck and river in 1999, increase over the study period as , the survival index decreases. There appears to be a strong relationship between the temperature gap and the resulting survival index in all of the data. When the temperature gap is 12 degrees or greater, survival is typically low, at 0.35 or less, with one exception in 1990 when it was quite good at 1.06. Conversely, with a temperature gap of nine degrees or less, survival is typically much better, at 0.43 or higher.

In recent VAMP experiments this change in temperature and how it may relate to mortality has been addressed by releasing a sub-set of the marked fish into net pens and holding them for 48 hours. In the several years of using these procedures very few mortalities have been observed. So while the difference in temperatures does not directly cause mortality it may subject the experimental fish to increased predation. To assess the quality of the fish used in the VAMP experiments, fish health studies are conducted using groups held in the net pens 24 hours after release.

Mortality could be related just to the higher temperatures and not necessarily the difference in temperatures between the hatchery truck and the river, but it is likely the two variables are interrelated.

Table 18. Historical releases at Miller Park (Sacramento) 1988-1996 and Broderick Boat Ramp (West Sacramento) 1997-1999, water year type, truck water and river water temperature at release, temperature difference and survival index. Prior to 1998, temperatures were measured in _F; for 1998 and 1999, temperatures were measured in _C and a conversion to _F is provided.

Release Date	Water Year Type	Truck Temp. _F	River Temp. _F	Temp. Difference _F	Survival Index	Delta Cross Channel Gates
05/05/88	Critical	54	62	+8	0.65	open *
06/23/88	Critical	55	74	+19	0.08	Open*
06/01/89	Dry	51	67	+16	0.16	Open
06/14/89	Dry	58	70	+12	0.20	Open

05/07/90	Critical	56	70	+14	1.06	Open
04/25/91	Critical	54	62	+8	0.78	Open
04/29/91	Critical	59	62	+3	0.49	Open
04/23/93	Above normal	53	61	+8	0.63	Closed
05/03/93	Above normal	56	62	+6	0.43	Closed
05/21/93	Above normal	51	65	+14	0.35	Closed
05/28/93	Above normal	55	64	+9	0.75	Open *
05/03/94	Critical	52	67	+15	0.07	Closed
05/24/94	Critical	49	71	+22	0.00	Closed
05/01/95	Wet	59.5	58.5	-1	0.63	Closed
04/25/96	Wet	48	57	+9	1.11	Closed
05/06/96	Wet	48	65	+7	0.58	Closed
04/15/97	Wet	48	63	+15	0.43	Closed
05/01/97	Wet	48	63	+15	0.40	Closed
05/15/97	Wet	52	72	+20	0.02	Open*
04/15/98	Wet	50	55.4	+5.4	0.66	Closed
04/27/98	Wet	59	60.8	+1.8	0.67	Closed
05/15/98	Wet	53.6	57.2	+3.6	0.93	Closed
04/15/99	Wet	59	55.4	-3.6	0.72	Closed
04/30/99	Wet	55	60.8	+5.8	0.42	Closed
05/14/99	Wet	54	64.4	+10.4	0.22	Closed

* DCC gate status reported for the day after release

VAMP Releases

Escapement in the San Joaquin River and tributaries has fluctuated dramatically for many years with peak escapement values near 70,000 fish. Escapement is related to San Joaquin River flows between April and June 2 ½ years earlier, when the juveniles are migrating to the ocean (Brandes, 2000). Results from various past smolt survival experiments conducted in the South Delta indicate that survival to Chipps Island is very low in some years and survival down the mainstem San Joaquin is generally greater than for smolts migrating down upper Old River. The barrier was identified as a way to increase smolt survival through the Delta by preventing smolts from migrating into upper Old River. The objective of the VAMP study has been to obtain estimates of survival through the San Joaquin Delta with a barrier in place. Since the barrier was not installed in 1999, the studies conducted in 1999 were considered complementary VAMP studies (Table 19). Survival was measured under the without barrier conditions and will be compared to with barrier estimates made in future years.

Method

The 1999 Vernalis Adaptive Management Plan (VAMP) study involved releases of CWT chinook salmon at three locations along the San Joaquin River; Mossdale, Dos Reis, and Jersey Point. Tagged chinook salmon were released to evaluate a 7000 cfs flow and a 3500 cfs export condition. Releases occurred April 19 for both Mossdale and Dos Reis, with a second release at Mossdale occurring on April 20. The release at Jersey Point was made on April 21. Merced River Hatchery fish were used for these releases (Table 19). For a full write up and analysis on the VAMP results see (Brandes,2000).

Results

The first set of releases had survival indices of 0.28, 0.42, and 0.72 for Mossdale, Dos Reis, and Jersey Point release groups respectively. Survival improved as the fish were released closer to Chipps Island. A second set of fish was released at Mossdale on April 20, and had a survival index of 0.05. This second Mossdale release had approximately 1,230 fish removed for efficiency studies at Mossdale. Flows ten days after release averaged between 6930 to 7280 cubic feet per second (cfs), and average exports varied from 2768 to 3450 cfs. Post VAMP flows remained high throughout April and May, averaging 6272 cfs with exports averaging 3460 cfs.

Table 19. Survival indices and expanded SWP and CVP salvage numbers for fall run releases made in the Sacramento / San Joaquin River Delta in 1999.

Release Date	Release Site	Number Released	Average FL of Fish (mm)	Truck Temp. (°F)	River Temp. (°F)	Survival Index	Expanded SWP Salvage	Expanded CVP Salvage
04/19/99	Mossdale	24765	79	53	62	0.20	463	438
	Mossdale	24773	79	53	62	0.36	475	521
	Mossdale	25279	79	53	62	0.30	497	546
	Total					0.28		
	Dos Reis	25161	80	54	63	0.43	17	86
	Dos Reis	24988	80	54	63	0.42	21	61
	Total					0.43		
04/20/99	Mossdale	23775	78	N/P	N/P	0.05	367	479
04/21/99	Jersey	24395	81	51	63	0.61	2	0
	Jersey	25101	81	51	63	0.85	46	12
	Total					0.73		

The number of recoveries at Chipps Island from the Mossdale releases was very low. As in previous years, such a low number of recoveries makes true differences in survival rates difficult to determine.

The high number of recoveries at the salvage facilities in 1999 seems to indicate that fish in the South Delta are using Old River as a migratory pathway when there is no head of Old River barrier (HORB). In 1997, the HORB was installed as part of the South Delta experiments and fewer marked fish were recovered at the fish facilities. Percentages of salvaged fish at the facilities were 0.46%, 0.31%, and 0.05% for Mossdale, Dos Reis, and Jersey Point, respectively in 1997. In 1999, the salvage facilities recovered 3.82% of the first Mossdale release and 3.56% of the second release with recoveries for Dos Reis and Jersey Point at 0.74% and 0.24%, respectively. Flows and exports in 1999 were similar to those in 1997. In 1998 flows on the San Joaquin were too high to allow the installation of the HORB, so south Delta survival was measured without the barrier. There were very few fish salvaged at the facilities in 1998 and survival indices were relatively high at 0.56, 0.59, and 1.84 for Mossdale, Dos Reis, and Jersey Point, respectively. San Joaquin River flows for the 1998 experiments averaged 22,000 cfs at Vernalis. This may suggest that at higher flows, not as much water from the San Joaquin River is diverted into Old River, thus decreasing the chances of salmon being entrained and ending up at the facilities (Table 20).

Table 20. Survival indices and expanded SWP and CVP salvage numbers for fall releases made in the Sacramento/San Joaquin River Delta 1997 through 1999. (N/P= Not provided)

Release Date	Release Site	Number Released	Average FL (mm)	Truck Temp. (°F)	River Temp. (°F)	Survival Index	Expanded SWP Salvage	Expanded CVP Salvage	% of Release Salvaged
04/28/97	Mossdale	48774	100	50	60	0.19	34	192	0.46%

04/29/97	Dos Reis	102480	74	56	60	0.15	130	264	0.38%
05/02/97	Jersey Point	51588	75	55	64	0.50	12	12	0.05%
04/16/98	Mossdale	77655	86	54	57	0.56	0	48	0.06%
04/17/98	Dos Reis	77373	86	54	59	0.59	0	0	0.0%
4/20/98	Jersey Point	50271	89	54	59	1.84	0	0	0.0%
04/19/99	Mossdale	74817	79	53	62	0.29	1,435	1,505	3.93%
04/19/99	Dos Reis	50149	80	54	63	0.42	38	147	0.74%
04/20/99	Mossdale	23775	78	N/P	N/P	0.05	367	479	3.56%
04/21/99	Jersey Point	49496	81	51	63	0.72	2	0	0.24%

Results of VAMP releases recovered in the trawl at Jersey Point indicate survival indices in 1999 were generally similar to those obtained at Chipps Island with the Mossdale index at 0.18, and the Dos Reis index at 0.40. Both the information at Jersey Point and Chipps Island indicate that being diverted into upper Old River decreases survival. The Dos Reis group would estimate survival for smolts not diverted into upper Old River as it is downstream of upper Old River. The Mossdale group would represent smolts that are exposed to being diverted into upper Old River. This comparison indicates smolts survive at twice the rate when they subject to being diverted into upper Old River. This provides further support for installation of the HORB when possible to improve survival through the Delta for smolts originating in the San Joaquin basin.

Absolute survival estimates (the ratio of the upstream index at Chipps Island divided by the downstream index) indicated that survival for the Mossdale group relative to the Jersey Point group was 0.38 and 0.58 for the Dos Reis group. These absolute estimates are higher than would have been expected based on the relationships established between flow and survival. It is hypothesized that the Jersey Point group was biased low because of interrupted sampling at Chipps Island during the recovery period (Brandes,2000).

In addition, an analyses was conducted to determine if increasing sampling at Chipps Island from one primarily day shift to two shifts incorporating the crepuscular periods could have biased our survival estimates. Results indicated that survival indices and estimates in 1999 were similar when either sampling regime was used.

Other recoveries in sampling gears during the 1998-1999 Field Year

Coded wire tagged late-fall, winter, spring and fall run are recovered in our various sampling throughout the field year (Table 21). They are summarized here but specific information on any one individual recovered marked fish is available on the IEP server.

Winter Run

Approximately 150,000 hatchery winter run from Coleman National Fish Hatchery were released in the upper Sacramento River at Caldwell Park on January 28. Fifty-five were recovered in our sampling (Sacramento trawl, Chipps Island trawl, and beach seine) in IEP real time sampling in the central/south Delta (Quimby East and Middle River/Prisoner Point), in VAMP sampling at Jersey Point (1) and at the State Fish Facility. They were recovered between February 8 and May 10 at forklength sizes between 71 and 145 millimeters. Twenty-one were recovered at Chipps Island with recovery dates between March 15 and April 19. Three were recovered in the normal salvage processing at the State Fish Facility with an additional 5 recovered in Handling and Trucking experiments.

This information would indicate that these winter run entered the Delta within a few weeks after release, but did not migrate past Chipps Island or reach the fish facilities prior to mid-March when they were between 89 and 145 millimeters.

Such information on the transit of marked fish through the river and Delta may provide a better understanding of how and when winter run use the delta and upriver for rearing and migration.

Late-fall Run

As mentioned previously, between December 1 and December 30, 1999 two groups of marked late-fall fish from Coleman National Fish Hatchery were released at Georgiana Slough and two were released at Ryde. In addition to those recovered at Chipps Island and at the fish facilities reported above, 7 of those released into Georgiana Slough and 25 of those released at Ryde were recovered in beach seining through-out the delta. Those released at Georgiana Slough were recovered in the central/western Delta. Those released at Ryde were recovered at stations along the Sacramento River downstream of Ryde. Recoveries from both releases were made between December 3 and February 25.

In addition thirty-four late fall released at Battle Creek were recovered in the beach seining in the lower Sacramento River (Reels Beach, Knight Landing, Verona and Elkhorn) and Delta (Miller Park, Garcia Bend, Clarksburg, Ryde, Isleton and B&W Marina). Approximately 800,000 late-fall are released at Battle Creek between November and January each year.

Spring Run

A total of 8 wild spring run released from Okie Dam on Butte Creek were recovered at Chipps Island in 1999. One additional recovery was made during sampling at Jersey Point for VAMP. Recoveries were made between April 2 and May 1. Size (forklength) at recovery was between 73 and 99 millimeters. Four others were recovered at Chipps Island between May 21 and May 27 from spring run Feather River releases made at Crockett. No spring run were recovered in the Delta at Sacramento or in the beach seining. This may reflect the relative few released (approximately 90,000) and the potential for less rearing in the Delta for this race of salmon.

Fall Run

Numerous fall run coded wire tagged fish are released through out the Central Valley. Many are recovered in our trawling at Sacramento, Chipps Island and in our beach seining in the lower Sacramento and San Joaquin River and Delta. Some were also recovered in the sampling at Jersey Point.

A total of 368 coded wire tagged fish were recovered in the Sacramento trawl from fall run hatchery fish released in Battle Creek (262), below Red Bluff Diversion Dam (1), at Bow River Resort (2), at Elkhorn (17), at Live Oak on the Feather River (16), Verona (42) and West Sacramento (28).

Those recovered at Sacramento, Chipps Island, Jersey Point, in Real Time sampling, in seining locations and at the State Water and Central Valley Project's fish facilities are provided in table 6. A map of real time stations is available on the web at <http://www.delta.dfg.ca.gov/data/rtm1999/sample-sites.asp>. The seining and trawling sites are listed in figure 5.

It is interesting to note that many fall run released on the Sacramento River (i.e. Battle Creek, Verona, Sacramento and Ryde) were recovered at Jersey Point indicating these fish moved into the central

Delta via Georgiana Slough or Three Mile Slough. It is also possible they moved upstream to Jersey Point after they migrated past the confluence of the Sacramento and San Joaquin Rivers. Seven smolts released at Port Chicago (downstream of Chipps Island) were recovered at Jersey Point and 35 were recovered at Chipps Island indicating there is some possible upstream migration or movement likely from the tides.

There is much to be learned from the recovery of tagged fish released through out the Central Valley. Reporting this data and making it available through the IEP server is the first step in using this information to better understand juvenile salmon survival and distribution through the Delta.

Table 21. Recovery location, number recovered and release location of coded wire tagged juveniles recovered in the various sampling gears in the juvenile salmon program, in real time monitoring and trawling at Jersey Point.

Location	Number Recovered	Release Location	Race
Chipps Island trawl	359	Battle Creek	Fall
Jersey Point trawl	186	Battle Creek	Fall
Discovery Park	1	Battle Creek	Fall
Elkhorn	1	Battle Creek	Fall
Federal Fish Facility	2	Battle Creek	Fall
Koket	1	Battle Creek	Fall
Little Mandeville West	1	Battle Creek	Fall
Middle River/Prisoners Pt	2	Battle Creek	Fall
Quimby East	2	Battle Creek	Fall
Reels Beach	1	Battle Creek	Fall
Sacramento Trawl	262	Battle Creek	Fall
State Fish Facility	2	Battle Creek	Fall
State Fish Facility	10	Battle Creek	Fall
Stump Beach	1	Battle Creek	Fall
Chipps Island trawl	1	Below RBDD	Fall
Sacramento trawl	1	Below RBDD	Fall
Colusa St. Park	1	Bow River Resort	Fall
Garcia Bend	1	Bow River Resort	Fall
San Joaquin River	1	Bow River Resort	Fall
Sacramento trawl	2	Bow River Resort	Fall
Jersey Point trawl	1	Bow River Resort	Fall

Chipps Island trawl	39	Dos Reis	Fall
Dos Reis	13	Dos Reis	Fall
Federal Fish Facility	15	Dos Reis	Fall
Little Mandeville West	3	Dos Reis	Fall
Middle River/Prisoners Pt	1	Dos Reis	Fall
Palm Tract	1	Dos Reis	Fall
San Joaquin River	2	Dos Reis	Fall
State Fish Facility	5	Dos Reis	Fall
State Fish Facility	8	Dos Reis	Fall
Turner Cut	3	Dos Reis	Fall
Webb Tract	1	Dos Reis	Fall
Jersey Point trawl	89	Dos Reis	Fall
B&W Marina	1	Elkhorn	Fall
Chipps Island trawl	8	Elkhorn	Fall
Clarksburg	11	Elkhorn	Fall
Discovery Park	4	Elkhorn	Fall
Discovery Pk. Alternate	1	Elkhorn	Fall
Elkhorn	337	Elkhorn	Fall
Federal Fish Facility	1	Elkhorn	Fall
Isleton	3	Elkhorn	Fall
Middle River/Prisoners Pt	1	Elkhorn	Fall
Quimby East	1	Elkhorn	Fall
Rio Vista	1	Elkhorn	Fall
Sacramento trawl	16	Elkhorn	Fall
Sacramento trawl	1	Elkhorn	Fall
State Fish Facility	2	Elkhorn	Fall
State Fish Facility	4	Elkhorn	Fall
Terminous	1	Elkhorn	Fall
Jersey Point trawl	3	Elkhorn	Fall
Chipps Island	51	Georgiana Slough	Fall
Federal Fish Facility	3	Georgiana Slough	Fall
Little Mandeville West	1	Georgiana Slough	Fall
Middle River/Prisoners Pt	2	Georgiana Slough	Fall
Palm Tract	1	Georgiana Slough	Fall
Quimby East	4	Georgiana Slough	Fall
State Fish Facility	1	Georgiana Slough	Fall
State Fish Facility	1	Georgiana Slough	Fall
State Fish Facility	6	Georgiana Slough	Fall
Terminous	1	Georgiana Slough	Fall
Webb Tract	2	Georgiana Slough	Fall
Jersey Point trawl	107	Georgiana Slough	Fall
Chipps Island	1	Grayson	Fall
Federal Fish Facility	30	Grayson	Fall

State Fish Facility	10	Grayson	Fall
State Fish Facility	28	Grayson	Fall
Turner Cut	1	Grayson	Fall
Jersey Point trawl	5	Grayson	
State Fish Facility	1	Gridley Boat Ramp	Fall
Jersey Point trawl	1	Gridley Boat Ramp	Fall
Chippis Island Trawl	24	Hatfield State Park	Fall
Columbia Cut	1	Hatfield State Park	Fall
Dos Reis	1	Hatfield State Park	Fall
Federal Fish Facility	259	Hatfield State Park	Fall
Little Mandeville West	4	Hatfield State Park	Fall
San Joaquin River	3	Hatfield State Park	Fall
State Fish Facility	83	Hatfield State Park	Fall
State Fish Facility	265	Hatfield State Park	Fall
Turner Cut	3	Hatfield State Park	Fall
Wetherbee	2	Hatfield State Park	Fall
Jersey Point trawl	26	Hatfield State Park	
Chippis Island Trawl	4	Isleton	Fall
Isleton	1	Isleton	Fall
Little Mandeville West	1	Isleton	Fall
Quimby East	1	Isleton	Fall
Sherman Island	1	Isleton	Fall
Brannan Island	1	Jersey Point	Fall
Chippis Island Trawl	59	Jersey Point	Fall
Federal Fish Facility	1	Jersey Point	Fall
Little Mandeville West	4	Jersey Point	Fall
Quimby East	3	Jersey Point	Fall
State Fish Facility	1	Jersey Point	Fall
State Fish Facility	5	Jersey Point	Fall
Webb Tract	1	Jersey Point	Fall
Jersey Point trawl	235	Jersey Point	
Columbia Cut	1	Knights Ferry	Fall
Federal Fish Facility	7	Knights Ferry	Fall
Chippis Island Trawl	7	La Grange	Fall
Columbia Cut	1	La Grange	Fall
Federal Fish Facility	161	La Grange	Fall
Quimby East	1	La Grange	Fall
Route 132	1	La Grange	Fall
State Fish Facility	61	La Grange	Fall
State Fish Facility	188	La Grange	Fall
Turner Cut	2	La Grange	Fall
Webb Tract	1	La Grange	Fall

Wetherbee	1	La Grange	Fall
Jersey Point trawl	15	La Grange	Fall
Chippis Island Trawl	2	Lighthouse Marina	Fall
Columbia Cut	1	Lighthouse Marina	Fall
Little Mandeville West	1	Lighthouse Marina	Fall
State Fish Facility	2	Lighthouse Marina	Fall
Venice Island	2	Lighthouse Marina	Fall
Webb Tract	1	Lighthouse Marina	Fall
Jersey Point trawl	2	Lighthouse Marina	Fall
Chippis Island Trawl	33	Live Oak	Fall
Sacramento Trawl	16	Live Oak	Fall
State Fish Facility	1	Live Oak	Fall
Big Beach	1	Mossdale	Fall
Chippis Island Trawl	38	Mossdale	Fall
Dos Reis	10	Mossdale	Fall
Federal Fish Facility	211	Mossdale	Fall
Little Mandeville West	2	Mossdale	Fall
Middle River/Prisoners Pt	3	Mossdale	Fall
Mossdale	17	Mossdale	Fall
Palm Tract	2	Mossdale	Fall
Quimby East	2	Mossdale	Fall
San Joaquin River	1	Mossdale	Fall
State Fish Facility	87	Mossdale	Fall
State Fish Facility	332	Mossdale	Fall
Turner Cut	4	Mossdale	Fall
Union Island	1	Mossdale	Fall
Webb Tract	2	Mossdale	Fall
Jersey Point trawl	61	Mossdale	Fall
Chippis Island Trawl	60	New Hope Landing	Fall
Federal Fish Facility	1	New Hope Landing	Fall
Little Mandeville West	2	New Hope Landing	Fall
Quimby East	1	New Hope Landing	Fall
State Fish Facility	1	New Hope Landing	Fall
State Fish Facility	1	New Hope Landing	Fall
Wimpy's	16	New Hope Landing	Fall
New Hope Landing	9	New Hope Landing	Fall
Federal Fish Facility	5	Oakdale Rec Area	Fall
State Fish Facility	1	Oakdale Rec Area	Fall
Big Beach	1	Old Fisherman's Club	Fall
Chippis Island Trawl	20	Old Fisherman's Club	Fall
Connection Slough	1	Old Fisherman's Club	Fall
Federal Fish Facility	135	Old Fisherman's Club	Fall
Little Mandeville West	2	Old Fisherman's Club	Fall

Mossdale	1	Old Fisherman's Club	Fall
Palm Tract	1	Old Fisherman's Club	Fall
Quimby East	1	Old Fisherman's Club	Fall
Route 132	1	Old Fisherman's Club	Fall
State Fish Facility	37	Old Fisherman's Club	Fall
State Fish Facility	199	Old Fisherman's Club	Fall
Wetherbee	2	Old Fisherman's Club	Fall
Jersey Point trawl	26	Old Fisherman's Club	Fall
Chippis Island Trawl	35	Port Chicago	Fall
Sherman Island	1	Port Chicago	Fall
Jesrey Point trawl	7	Port Chicago	Fall
Chippis Island Trawl	87	Ryde	Fall
Clarksburg	1	Ryde	Fall
Federal Fish Facility	1	Ryde	Fall
Isleton	3	Ryde	Fall
Koket	3	Ryde	Fall
Middle River/Prisoners Pt	1	Ryde	Fall
Quimby East	3	Ryde	Fall
Rio Vista	3	Ryde	Fall
State Fish Facility	2	Ryde	Fall
Jersey Point trawl	36	Ryde	Fall
Chippis Island Trawl	115	Sherman Island	Fall
Federal Fish Facility	2	Sherman Island	Fall
Little Mandeville West	2	Sherman Island	Fall
Quimby East	1	Sherman Island	Fall
State Fish Facility	1	Sherman Island	Fall
Webb Tract	1	Sherman Island	Fall
Wimpy's	2	Sherman Island	Fall
Chippis Island Trawl	4	Thermalito Bypass	Fall
Jersey Point trawl	1	Thermalito Bypass	Fall
Chippis Island Trawl	1	Tuolumne River	Fall
Federal Fish Facility	17	Tuolumne River	Fall
San Joaquin River	1	Tuolumne River	Fall
State Fish Facility	4	Tuolumne River	Fall
State Fish Facility	17	Tuolumne River	Fall
Chippis Island Trawl	13	Upper Merced @ MRFF	Fall
Federal Fish Facility	108	Upper Merced @ MRFF	Fall
Palm Tract	1	Upper Merced @ MRFF	Fall
San Joaquin River	1	Upper Merced @ MRFF	Fall
State Fish Facility	49	Upper Merced @ MRFF	Fall
State Fish Facility	177	Upper Merced @ MRFF	Fall
Wetherbee	3	Upper Merced @ MRFF	Fall
Jersey Point trawl	14	Upper Merced @ MRFF	Fall

State Fish Facility	1	Upper Old River	Fall
Chippis Island Trawl	71	Verona	Fall
Clarksburg	9	Verona	Fall
Discovery Park	27	Verona	Fall
Elkhorn	26	Verona	Fall
Federal Fish Facility	2	Verona	Fall
Garcia Bend	2	Verona	Fall
Georgiana Slough	3	Verona	Fall
Isleton	3	Verona	Fall
Koket	3	Verona	Fall
Rio Vista	1	Verona	Fall
Sacramento Trawl	17	Verona	Fall
Sacramento Trawl	25	Verona	Fall
State Fish Facility	3	Verona	Fall
State Fish Facility	6	Verona	Fall
Steamboat Sl. (mouth)	1	Verona	Fall
Verona	2	Verona	Fall
Jersey Point trawl	40	Verona	Fall
Chippis Island Trawl	120	West Sacramento	Fall
Federal Fish Facility	1	West Sacramento	Fall
Garcia Bend	1	West Sacramento	Fall
Sacramento Trawl	28	West Sacramento	Fall
State Fish Facility	1	West Sacramento	Fall
State Fish Facility	3	West Sacramento	Fall
Steamboat Sl. (mouth)	2	West Sacramento	Fall
Terminus	1	West Sacramento	Fall
Webb Tract	1	West Sacramento	Fall
Jersey Point trawl	51	West Sacramento	Fall
Chippis Island Trawl	5	Woodbridge Dam	Fall
Federal Fish Facility	1	Woodbridge Dam	Fall
State Fish Facility	1	Woodbridge Dam	Fall
Wimpy's	1	Woodbridge Dam	Fall
Jersey Point trawl	2	Woodbridge Dam	Fall
Chippis Island Trawl	9	Yolo Bypass - County Rd 16	Fall
State Fish Facility	1	Yolo Bypass - County Rd 16	Fall
B&W Marina	1	Battle Creek	LateFall
Chippis Island Trawl	190	Battle Creek	LateFall
Clarksburg	2	Battle Creek	LateFall
Elkhorn	13	Battle Creek	LateFall
Federal Fish Facility	2	Battle Creek	LateFall
Garcia Bend	4	Battle Creek	LateFall
Isleton	1	Battle Creek	LateFall
Knights Landing	1	Battle Creek	LateFall

Koket	3	Battle Creek	LateFall
Miller Park	3	Battle Creek	LateFall
Reels Beach	4	Battle Creek	LateFall
Sacramento Trawl	60	Battle Creek	LateFall
State Fish Facility	2	Battle Creek	LateFall
State Fish Facility	6	Battle Creek	LateFall
Verona	2	Battle Creek	LateFall
Antioch Dunes	1	Georgiana Slough	LateFall
B&W Marina	2	Georgiana Slough	LateFall
Chippis Island Trawl	24	Georgiana Slough	LateFall
Eddo's	2	Georgiana Slough	LateFall
Federal Fish Facility	3	Georgiana Slough	LateFall
State Fish Facility	1	Georgiana Slough	LateFall
State Fish Facility	7	Georgiana Slough	LateFall
Terminous	2	Georgiana Slough	LateFall
Chippis Island	1	Port Chicago	LateFall
Chippis Island	47	Ryde	LateFall
Isleton	9	Ryde	LateFall
Koket	7	Ryde	LateFall
Rio Vista	9	Ryde	LateFall
Chippis Island Trawl	4	Crockett	Spring
Chippis Island Trawl	8	Okie Dam	Spring
Jersey Point Trawl	1	Okie Dam	Spring
Brannan Island	1	Caldwell Park	Winter
Chippis Island Trawl	21	Caldwell Park	Winter
Clarksburg	3	Caldwell Park	Winter
Colusa St. Park	4	Caldwell Park	Winter
Discovery Pk. Alternate	1	Caldwell Park	Winter
Knights Landing	5	Caldwell Park	Winter
Koket	1	Caldwell Park	Winter
Middle River/Prisoners Pt	1	Caldwell Park	Winter
Quimby East	1	Caldwell Park	Winter
Sacramento Trawl	7	Caldwell Park	Winter
State Fish Facility	5	Caldwell Park	Winter
State Fish Facility	3	Caldwell Park	Winter
Verona	1	Caldwell Park	Winter
Jersey Point Trawl	1	Caldwell Park	Winter

References

- Brandes, P.L. 2000. 1999 South Delta Salmon Smolt Survival Studies. Available from USFWS, 4001 N. Wilson Way, Stockton CA 95205. 32 pgs.
- Dauble, D.D., Page, T.L., Hanf, W.R. Jr. 1989. Spatial Distribution of Juvenile Salmonids in the Hanford Reach, Columbia River. *Fishery Bulletin*. 87:4.
- Healy, M.C. 1991. Life history of chinook salmon (*Oncorhynchus tshawytscha*). P 311- 394. In: Groot, C., and L. Margolis (eds.). Pacific Salmon Life Histories. UBC Press, Vancouver.
- Fisher, F.W. 1994. Past and present status of Central Valley chinook salmon. *Conservation. Biol.* 8(3): 870-873.
- United States Fish and Wildlife Service. 1981. Distribution and food habits of juvenile salmonids in the Duwamish Estuary, Washington 1980. USFWS Fisheries Assistance Office Olympia Washington.
- Reimers, P. E. 1968. Social behavior among juvenile fall chinook salmon. *Journal of Fisheries Research Board of Canada*. 25: 2005-2008.
- Slater, D.W. 1963. Winter-run chinook salmon in the Sacramento River, California with notes on water temperature requirements for spawning. U.S. Fish and Wildlife Special Science Report 461. Washington D.C.
- Thomas et al. 1969. Effect of yolk sac absorption on the swimming ability of fall chinook salmon. *Trans. Amer. Fish. Soc.* 3:406-410.
- United States Fish and Wildlife Service, 1993. Annual progress report "Abundance and survival of juvenile chinook salmon in the Sacramento-San Joaquin Estuary".
- United States Fish and Wildlife Service, 1994. Annual progress report "Abundance and survival of juvenile chinook salmon in the Sacramento-San Joaquin Estuary".
- United States Fish and Wildlife Service, 1995. Annual progress report "Abundance and survival of juvenile chinook salmon in the Sacramento-San Joaquin Estuary".
- United States Fish and Wildlife Service, 1995. "Working Paper on Restoration Needs. Habitat Restoration Actions to Double Natural Production of Anadromous fish in the Central Valley of California". Volume 2.
- United States Geological Survey, 1997. Water Resources data -- California water year 1996, Volume 4, Northern Central Valley basins and the Great Basin from Honey Lake Basin to Oregon State Line. Sacramento, CA.
- United States Fish and Wildlife Service. 1987. Exhibit 31: The needs of chinook salmon, *Oncorhynchus tshawytscha* in the Sacramento-San Joaquin Estuary.
- United States Geological Survey. 1995. California Data Exchange Center.
- Wickwire, R.H., Stevens, D.E. 1966. Migration and distribution of young king salmon, *Oncorhynchus tshawytscha*, in the Sacramento River near Collinsville. Anadromous Fisheries Branch Administrative Report No. 71-4. California Department of Fish and Game.

Personal Communications

Colleen Harvey, California Department of Fish and Game, Red Bluff.