

# **Watershed Loading, Hydrodynamic, and Water Quality Modeling in Support of the Loma Alta Slough Bacteria and Nutrient TMDL**

**Submitted to:**

San Diego Regional Water Quality Control Board

Agreement No. 09-075-190

**Submitted by:**

Coastal Monitoring Associates, LLC  
4741 Orchard Ave.  
San Diego, CA 92107



Southern California Coastal Water  
Research Project  
3535 Harbor Blvd., Suite 110  
Costa Mesa, CA 92626



**April 2013**

**Technical Report 666**

*This Page Intentionally Left Blank*

## TABLE OF CONTENTS

<b>1</b>	<b>Introduction .....</b>	<b>1</b>
1.1	Loma Alta Slough and Watershed Background.....	1
1.2	Modeling Approach.....	4
<b>2</b>	<b>Watershed Loading Model Calibration and Validation .....</b>	<b>5</b>
2.1	Methods.....	5
2.1.1	Data Sources to Support Model Development.....	5
2.1.2	Processing of Time Series Data .....	15
2.1.3	Methodology to Develop and Calibrate Hydrologic Model.....	17
2.1.4	Methodology to Develop and Validate Watershed Nutrient and Bacteria Loading Model	23
2.2	Results and Discussion of Watershed Hydraulic Loading Model Calibration and Validation .....	24
2.3	Results and Discussion of Watershed Nutrient and Bacteria Loading Model Validation .....	28
2.3.1	Nutrients.....	28
2.3.2	Bacteria.....	28
2.4	Uncertainties in Watershed Loading Model Results.....	30
2.5	Watershed Modeling Summary.....	31
<b>3</b>	<b>ESTUARY HYDRODYNAMIC MODEL CALIBRATION AND VALIDATION .....</b>	<b>32</b>
3.1	METHODS.....	32
3.1.1	Previous Work.....	32
3.1.2	Model Selection .....	32
3.1.3	Data Sources .....	33
3.1.4	Model Set Up and Development.....	34
3.2	Results and Discussion of the Estuary Hydrodynamic Model .....	39
3.2.1	Wet Season (January-May 2008) .....	39
3.2.2	Dry Season (May –October 2008) .....	49
3.3	Estuary Hydrodynamic Modeling Uncertainties .....	52

<b>3.4</b>	<b>Summary of Estuary Hydrodynamic Modeling .....</b>	<b>53</b>
<b>4</b>	<b>Estuary Bacteria Model Calibration and Validation .....</b>	<b>54</b>
<b>4.1</b>	<b>Methods.....</b>	<b>54</b>
4.1.1	Data Sources .....	54
4.1.2	Model Development .....	55
<b>4.2</b>	<b>RESULTS AND DISCUSSION OF BACTERIA SIMULATION MODEL .....</b>	<b>55</b>
4.2.1	Model Calibration for Wet Weather .....	55
4.2.2	Model Calibration for Dry Weather .....	59
<b>4.3</b>	<b>Uncertainties in Bacteria Simulation Modeling .....</b>	<b>62</b>
<b>4.4</b>	<b>Summary of Bacteria Simulation Modeling .....</b>	<b>62</b>
<b>5</b>	<b>ESTUARY EUTROPHICATION MODEL CALIBRATION AND VALIDATION .....</b>	<b>63</b>
<b>5.1</b>	<b>Methods.....</b>	<b>63</b>
5.1.1	Data Sources .....	63
5.1.2	Supplemental Data Sources for Calibration and Validation .....	65
5.1.3	Model Development .....	66
5.1.4	Model Simulations .....	68
<b>5.2</b>	<b>Results and Discussion of Eutrophication Model.....</b>	<b>69</b>
5.2.1	Dissolved Oxygen .....	69
5.2.2	Simulations of DO New Boundary Data for August 6-7, 2012 .....	73
<b>5.3</b>	<b>Sensitivity Analysis.....</b>	<b>77</b>
5.3.1	Calibration and Sensitivity Analysis for Macroalgae .....	84
5.3.2	Calibration and Validation of Slough Nutrient Concentrations .....	91
<b>5.4</b>	<b>Uncertainties in Eutrophication Modeling.....</b>	<b>95</b>
5.4.1	Dissolved Oxygen .....	95
5.4.2	Macroalgae .....	95
5.4.3	Nutrient Concentrations.....	95
<b>5.5</b>	<b>Summary of Eutrophication Modeling .....</b>	<b>95</b>
<b>6</b>	<b>Model Application .....</b>	<b>97</b>

<b>6.1</b>	<b>Use of Models to Calculate Numeric Targets.....</b>	<b>97</b>
6.1.1	Bacteria.....	97
6.1.2	Eutrophication .....	98
<b>6.2</b>	<b>Use of Models to Calculate Total Maximum Daily Loads.....</b>	<b>106</b>
6.2.1	Approach to Estimate TMDL.....	106
6.2.2	Results and Discussion .....	107
<b>6.3</b>	<b>Use of Models to Estimate Sources of Bacteria and Nutrients from Land Use.....</b>	<b>116</b>
6.3.1	Methods .....	116
6.3.2	Results and Discussion .....	116
<b>6.4</b>	<b>Use of Model to Analyze Implementation Scenarios.....</b>	<b>118</b>
6.4.1	Methods .....	118
6.4.2	Results and Discussion of Scenario Analyses.....	120
6.4.3	Results and Discussion of Eutrophication Scenarios.....	130
6.4.4	Summary of Implementation Scenario Analysis For Bacteria and Nutrients .....	130
<b>7</b>	<b>Summary of Modeling Work and Recommendations .....</b>	<b>133</b>
7.1	Summary of Model Calibration and Validation .....	133
7.2	Use of the Model to Facilitate Discussion on the Nutrient and Bacteria TMDL .....	135
<b>8</b>	<b>References .....</b>	<b>137</b>

## List of Figures

Figure 1.1. Location map for the Loma Alta Slough and watershed in southern California. ....	2
Figure 1.2. Detail map of Loma Alta Slough (or Lagoon) showing inlet to the ocean and the location of sampling stations.....	3
Figure 2.1. Digital Elevation Model (DEM) used for the Loma Alta Slough watershed hydrologic model.....	7
Figure 2.2. SANDAG 2009 LULC data, clipped to the delineated area of the Loma Alta Slough watershed. ....	8
Figure 2.3. SSURGO hydrologic soils group data, clipped to the delineated Loma Alta Slough watershed. ....	9
Figure 2.4. Location of CIMIS stations 150 and 173 relative to the Loma Alta Slough.....	9
Figure 2.5. Plot of observed stream discharge data associated with mass emission station. Top and bottom panels represent different months as examples of flow patterns. ....	17
Figure 2.6. Delineated Loma Alta Slough watershed and derived stream network.....	17
Figure 2.7. Percent slope derived from 10-m resolution DEM for the Loma Alta watershed. ....	18
Figure 2.8. Plots of simulated (red) and measured (blue) hydrographs for Storms 1 and 2 (a), Storms 3 and 4 (b), and Storms 5 and 6 (c); see Table 2.10 calibration/validation dates.....	27
Figure 2.9. Comparison of measured and modeled stormwater bacteria from the Loma Alta Slough watershed (10 <sup>th</sup> , 25 <sup>th</sup> , 50 <sup>th</sup> , 75 <sup>th</sup> , and 90 <sup>th</sup> simulated percentiles are shown). ....	29
Figure 2.10. Comparison of measured and modeled stormwater nutrients from the Loma Alta Slough watershed. ....	29
Figure 2.11. Comparison of measured and modeled stormwater bacteria from the Loma Alta Slough watershed. ....	30
Figure 3.1. The EFDC model grid for Loma Alta Slough.....	35
Figure 3.2. Schematic model cross sections, depths, sand berm, riverine and ocean boundaries. ....	36
Figure 3.3. Dry weather base flows (newly measured dry based flow for July 7-Aug 31, 2011 are plotted with the same months/dates for 2008).....	38
Figure 3.4. Close-up look of dry weather base flows (newly measured dry based flow for July 7-Aug 31, 2011 are plotted with the same months/dates for 2008). ....	39
Figure 3.5. Simulated water surface elevations during different tidal and river discharge conditions (vertical dimensions are up to the scale, horizontal dimension of the river stretch are off the scale distance from Segment Station #7 to Segment Station #28 is about 400 m). ....	40
Figure 3.6. Means and RMS of WSE at OI (above) and Segment 1 (bottom).....	41
Figure 3.7. Comparisons of measured (red) and modeled (blue for 60 cm and green for 100 cm berm heights) water surface elevations at OI, with runoff discharge in black for January, 2008. ....	42
Figure 3.8. Comparisons of measured (red) and modeled (blue for 60 cm and green for 100 cm berm heights) water surface elevations at SEG#1, with runoff discharge in black for January, 2008. ....	43
Figure 3.9. Comparison of measured (red) and modeled (blue for bottom and green for surface layer) (a) salinities at OI, using adjusted runoff discharge (in black) for Jan, 2008, (b) salinities at Segment 1, using simulated runoff discharge (in black) for Jan, 2008, (c) salinities at SEG1, using modified discharge (in black) for Mar, 2008, and (d) salinities at SEG1, using modified discharge (in black) for Apr, 2008. ....	47

Figure 3.10. Comparisons of measured (red) and modeled (blue for bottom and green for surface layer) (a) temperature at OI for Jan, 2008, (b) temperature at OI for Apr, 2008, (c) temperature at SEG1 for Jan, 2008, and (d) temperature at SEG1 for Apr, 2008. .	48
Figure 3.11. Water surface elevation in Loma Alta Slough during the dry season (ocean tides are in red for comparison). .	49
Figure 3.12. Measured and simulated salinities during slough open period (Jan-Apr 2008) and slough closure period (May 15-July 30, 2008) with tides plotted in the background. .	51
Figure 3.13. Close-up comparison between simulated and measured salinities and tides during the closure period. Salinities peaked up during June 4 and July 4 from overtopping of the tides and sand berm of 1.54 m is obtained by calibration. .	51
Figure 3.14. Tides during Jan-Oct 2008 with references to 1) NAVD, 2) Model reference (1.69 m), 3) Existing sand berm height during slough closure (1.54 m), and 4) Mean Lower High Water (MLHW). .	52
Figure 4.1. Model/measurement comparisons for enterococci during the 2008 wet weather at Segment 1 (above) and Ocean Inlet (bottom). .	56
Figure 4.2. Model/measurement comparisons for fecal coliform during the 2008 wet weather at Segment 1 (above) and Ocean Inlet (bottom). .	57
Figure 4.3. Model/measurement comparisons for total coliform during the 2008 wet weather at Segment 1 (above) and Ocean Inlet (bottom). .	58
Figure 4.4. Model/measurement comparisons of fecal coliform (top), total coliform, enterococcus at Segment 1 for the 2008 dry season). .	60
Figure 4.5. Model/measurement comparisons of Fecal coliform, total coliform and enterococcus at Ocean Inlet for the 2008 dry season. .	61
Figure 5.1. Processes and state variables simulated in the WASP 7.1 model. .	66
Figure 5.2. Loading concentrations measured at ME station. .	67
Figure 5.3. Dissolved oxygen model/data comparison between Segment 1 (top) and Ocean Inlet (bottom) for the period of January-May 2008. .	70
Figure 5.4. Dissolved oxygen model/data comparison between Segment 1 (top) and Ocean Inlet (bottom) for the period of May-October 2008. .	71
Figure 5.5. Comparison of predicted surface and bottom water dissolved oxygen based on 2008 input data with measured surface and bottom water data in 2010 for Segment 1 (top) and Ocean Inlet (bottom). .	72
Figure 5.6. Predicted DO concentrations and contributions from macroalgae DO production and consumption and CBOD. .	73
Figure 5.7a. Measured boundary condition for DO during August 6-7 between 2008 and 2012. .	74
Figure 5.7b. Measured boundary condition for BOD during August 6-7 between 2008 and 2012. .	74
Figure 5.8a. Simulated DO at surface Segment 1 between the 2008 and the new 2012 DO data at the boundary. .	75
Figure 5.8b. Simulated DO at bottom Segment 1 between the 2008 and the new 2012 DO data at the boundary. .	75
Figure 5.8c. Simulated DO at surface (OI) between the 2008 and the new 2012 DO data at the boundary. .	76
Figure 5.8d. Simulated DO at bottom (OI) between the 2008 and the new 2012 DO data at the boundary. .	76
Figure 5.9a. Sensitivity analysis of DO concentrations for 2X the rates of BOD decay, respiration and mineralization. .	78

Figure 5.9b. Sensitivity analysis of DO concentrations for 10X the rates of BOD decay, respiration, and mineralization.....	79
Figure 5.10. Sensitivity analysis for DO concentrations with and without macroalgae effects. ....	79
Figure 5.11. Sensitivity analysis for DO concentrations with upstream boundary conditions for DO = 5 mg L <sup>-1</sup> and 7 mg L <sup>-1</sup> . ....	80
Figure 5.12. Sensitivity analysis for DO reduction of nutrient loads.....	80
Figure 5.13a. Sensitivity analysis for DO at OI surface 2008 and 2012.....	81
Figure 5.13b. Sensitivity analysis for DO at OI bottom 2008 and 2012. ....	82
Figure 5.13c. Sensitivity analysis for DO at Segment 1 surface 2008 and 2012.....	82
Figure 5.13d. Sensitivity analysis for DO at Segment 1 bottom 2008 and 2012. ....	83
Figure 5.14. Comparison between predicted and measured macroalgae biomass at OI. ....	84
Figure 5.15. Predicted and measured macroalgae concentrations during 2008. ....	85
Figure 5.16a. Simulated results of baseline condition, increased growth rate and increased death rate on macroalgae biomass at OI.....	86
Figure 5.16b. Simulated results of baseline condition, increased growth rate and increased death rate on macroalgae biomass at Segment 1.....	87
Figure 5.17. Time series of growth limitation functions for nitrogen, phosphorus and light. ....	88
Figure 5.18. Simulated macroalgae concentrations for the three scenarios defined in Table 5.2 (measurements were taken during July and September 2008).....	89
Figure 5.19a. Macroalgae biomass at OI for nutrient load reduction scenarios. ....	90
Figure 5.19b. Macroalgae biomass at OI for nutrient load reduction scenarios. ....	91
Figure 5.20. Comparison of observed versus predicted DIN (ammonium + NO <sub>x</sub> ; top left panel), total N (top right panel) and total P (bottom left). Predicted = X Observed is the linear regression model of observed versus predicted, no intercept, where X is the model slope. R <sup>2</sup> represents model fit. Color of dot represent sampling period, where blue = January, yellow = April, green= July and red = October 2008.....	92
Figure 5.21. Simulated and measured total inorganic-N (above), total-N (middle) and total-P (bottom) at OI station.....	93
Figure 5.22. Simulated and measured total inorganic-N (above), total-N (middle) and total-P (bottom) at OI station.....	94
Figure 6.1. Examples of three options for temporal aggregation of FIB data: daily mean, daily maximum an 8 a.m. options.....	98
Figure 6.2. Examples of three types of primary producers found in Loma Alta Slough: macroalgae on tidal flats (top left) and floating macroalgae during a closed inlet (top right), microphytobenthos (mid panel) and phytoplankton (bottom panel). ....	102
Figure 6.3. Graphs showing analysis decline in total coliform concentration in Loma Alta Slough as a function of % reduction in dry weather flow for an 8:00 a.m. single grab event (top panel), daily mean (middle panel, and 30-day geomean (bottom panel). Graphs show allowable exceedance days at 0% (black), 5% (red) and 10% (green) of dry days per year. ....	109
Figure 6.4. Graphs showing analysis decline in fecal coliform concentration in Loma Alta Slough as a function of % reduction in dry weather flow for an 8:00 a.m. single grab event (top panel), daily mean (middle panel, and 30-day geomean (bottom panel). Graphs show allowable exceedance days at 0% (black), 5% (red) and 10% (green) of dry days per year. ....	110
Figure 6.5. Graphs showing analysis decline in enterococcus concentration in Loma Alta Slough as a function of % reduction in dry weather flow for an 8:00 a.m. single grab event (top panel), daily mean (middle panel), and 30-day geomean of daily mean (bottom	



panel). Graphs show allowable exceedance days at 0% (black), 5% (red) and 10% (green) of dry days per year. ....	111
Figure 6.6. Graphs showing analysis of decline of FIB concentration in Loma Alta Slough as a function of % reduction in wet weather FIB loads for an 8:00 a.m. single grab event (black) and daily mean (red) for total coliform (top panel), fecal coliform (middle panel) and enterococcus (bottom panel). ....	112
Figure 6.7. Graphs showing analysis of decline in floating macroalgal biomass in Loma Alta Slough as a function of % reduction in dry weather flow, relative to the macroalgal biomass numeric target = $90 \mu\text{g L}^{-1}$ ). ....	113
Figure 6.8. Graphs showing analysis of decline in TN (top panel) and TP (bottom panel) in Loma Alta Slough as a function of % reduction in dry weather TN or TP loads, relative to the numeric targets for flowing waters ( $1 \text{ mg L}^{-1}$ TN and $0.1 \text{ mg L}^{-1}$ TP ) and standing waters ( $0.5 \text{ mg L}^{-1}$ TN and $0.05 \text{ mg L}^{-1}$ TP). ....	115
Figure 6.9. Conceptual model for the scenario of dilution by withdrawal of slough water. ....	119
Figure 6.10. Scenario #1 Model Results: Enterococci (Above), Fecal Coliform (middle) and Total Coliform (bottom). ....	123
Figure 6.11. Scenario #2 Model Results: Enterococci (Above), Fecal Coliform (middle) and Total Coliform (bottom). ....	124
Figure 6.12. Scenario #3 Model Results: Enterococci (Above), Fecal Coliform (middle) and Total Coliform (bottom). ....	125
Figure 6.13. Scenario #4 Model Results: Enterococci (Above), Fecal Coliform (middle) and Total Coliform (bottom). ....	126
Figure 6.14. Scenario #5 Model Results: Enterococci (Above), Fecal Coliform (middle) and Total Coliform (bottom). ....	127
Figure 6.15. Concentrations for equilibrium for Scenario #6. ....	128
Figure 6.16. Concentrations for equilibrium for Scenario #7. ....	129
Figure 6.16. Simulated total-N, total-P and macroalgae biomass at OI for inlet openness and load reduction scenarios(C/Chla ratio = 120). ....	131
Figure 6.17. Simulated total-N, total-P and macroalgae biomass at Segment 1 for inlet openness and load reduction scenarios (C/Chla ratio = 120). ....	132

## LIST OF TABLES

Table 2.1. SDHM pervious land types (PERLND = pervious land area).....	10
Table 2.2. SDHM impervious land types (IMPLND = impervious land area).....	12
Table 2.3. Loma Alta Slough mass emission monitoring results. ....	13
Table 2.4. Stormwater nutrient concentration from land uses in Ackerman and Schiff (2003) and Sengupta et al. (in review). ....	14
Table 2.5. Stormwater bacteria concentrations from land uses.....	15
Table 2.6. Mapping from 2009 SANDAG LULC data to SDHM vegetation/surface types. ....	20
Table 2.7. Areas for the unique SDHM Vegetation/Surface types represented in the Loma Alta Slough watershed model for the drainage area above the mass emission station.....	21
Table 2.8. Areas for the unique SDHM Vegetation/Surface types represented in the Loma Alta Slough watershed model for the drainage area below the mass emission station and above the main basin outlet located at the most upstream point of the EFDC model grid.....	22
Table 2.9. Percent imperviousness for the water quality watershed model (Ackerman and Schiff 2003). ....	24
Table 2.10. Six storms for hydrological model calibration/validation. ....	26
Table 3.1. Summary statistics for water surface elevations (means and root mean square error) between model and measurement 2008. ....	40
Table 4.1. Summary of validation data for wet weather bacteria concentrations. ....	59
Table 5.1. Summary of the timing of data collection for eutrophication in Loma Alta Slough by time period, types of sampling event, and organization ....	65
Table 5.2. WASP model parameters and values. ....	68
Table 5.3. Dissolved oxygen model validation: Percentages of time DO <5 mg L <sup>-1</sup> by field and model data Jan-Oct 2008 and Sept-Oct 2010. ....	69
Table 5.4. Growth and death rates for macroalgae biomass sensitivity analysis simulations.....	85
Table 6.1. Numeric targets used for model scenario study. ....	97
Table 6.2. SDRWQCB Basin Plan objectives for oxygen and biostimulatory substances (SDRWQCB Basin Plan XXXX). ....	99
Table 6.3. Definition of estuarine beneficial uses applicable to selection of E-NNE indicators..	101
Table 6.3. EU WDF proposed classification of macroalgal abundance as a function of dry weight weight biomass and percent cover (from Scanlan et al. 2007). Scanlan et al. (2007) wet weight values were transformed to dry weight using Bight 08 Eutrophication Assessment data (McLaughlin et al., in press). Combination of biomass are cover are ranked from low macroalgal abundance = very high ecological condition (blue) to high macroalgal abundance = very low ecological condition (red).....	103
Table 6.5. Table of % reduction in dry weather flow required to meet FIB TMDL numeric targets. Slope (b) and y-intercept (a) refer to regression relationship used to extrapolate fow reduction	

required to meet Slough FIB numeric targets. Ent = enterococcus, FC = fecal coliform, and TC = total coliform. Exceedance rate refers to allowable exceedance rate based (currently at 0%)... 108

Table 6.6. Table of % reduction in wet weather FIB loads required to meet FIB TMDL numeric targets. Slope (b) and y-intercept (a) refer to regression relationship used to extrapolate load reduction required to meet Slough FIB numeric targets. %Reduction refers to reduction in FIB load. 108

Table 6.7. Table of percent reduction in dry weather TN and TP loads required to meet macroalgal numeric target discussed in Section 6.1. Slope and y-intercept refer to regression relationship used to extrapolate flow reduction required to meet the numeric target. Ocean inlet refers to the section downstream of the railroad bridge. Segment 1 (upstream) refers to the section of the Slough upstream of the railroad bridge to the Coast Highway..... 113

Table 6.8 Table of percent reduction in dry weather TN loads required to meet the TN numeric target based on a flowing waters (TN = 1 mg L<sup>-1</sup>) and standing water (TN =0.5 mg L<sup>-1</sup>) interpretation of the Basin Plan Biostimulatory Objective. Ocean inlet refers to the section downstream of the railroad bridge. Segment 1 (upstream) refers to the section of the Slough upstream of the railroad bridge to the Coast Highway. .... 114

Table 6.9 Table of percent reduction in dry weather TN and TP loads required to meet the TN and TP numeric targets based on a flowing waters (TP = 0.1 mg L<sup>-1</sup>) and standing water (TP = 0.05 mg L<sup>-1</sup>) interpretation of the Basin Plan Biostimulatory Objective. Ocean inlet refers to the section downstream of the railroad bridge. Segment 1 (upstream) refers to the section of the Slough upstream of the railroad bridge to the Coast Highway. .... 114

Table 6.7. Nutrient Land Use Flux (lb/ac/yr)..... 117

Table 6.8. Bacteria Land Use Flux (10<sup>9</sup>/ac/yr)..... 118

Table 6.9. Summary of scenario effects on number of exceedance days for enterococcus. Numbers incorporate the 22% allowable exceedance days for wet weather (n = 38 days) and 0% exceedance allowance for dry weather. .... 121

Table 6.10. Summary of scenario effects on number of exceedance days for enterococcus. Numbers incorporate the 22% allowable exceedance days for wet weather (n = 38 days) and 0% exceedance allowance for dry weather. .... 121

Table 6.11. Summary of scenario effects on number of exceedance days for enterococcus. Numbers incorporate the 22% allowable exceedance days for wet weather (n = 38 days) and 0% exceedance allowance for dry weather. .... 122

# 1 INTRODUCTION

Loma Alta Slough is a small coastal estuarine wetland located at the mouth of Loma Alta Creek next to Buccaneer Beach Park and is entirely within the City of Oceanside in north San Diego County, California. It has intermittent connection to the Pacific Ocean due to natural closing and opening of the mouth of the Estuary. The Estuary provides refuge, foraging areas, and breeding grounds for coastal marine species, including threatened and endangered species. The watershed also serves as habitat for approximately 100 species of wildlife including migratory birds, raptors, and the federally threatened California gnatcatcher (City of Oceanside 2003). The Estuary receives freshwater inputs from an approximately 25.4 sq. km watershed, of which 95% is within the City of Oceanside, while the remaining 5% is within the City of Vista, the California Department of Transportation (Caltrans), North County Transit District, and the County of San Diego.

Loma Alta Slough was placed on the Section 303(d) list of Water Quality Limited Segments in 1996 for eutrophic conditions and indicator bacteria with an estimated affected area affected of 3.3 hectares out of a total of 43.3 hectares. To meet water quality standards, the Slough is subject to the development of a total maximum daily load (TMDL) to restore appropriate beneficial uses (USEPA 2009).

## 1.1 Loma Alta Slough and Watershed Background

Loma Alta Slough (Figure 1.1), located north of Highway 78, in Oceanside, California, is an engineered estuarine system with the main reach of the slough extending about 400 m from the Pacific Ocean shoreline to Pacific Coast Highway with nearly a constant width of 14 m. The listed portion of the Slough is downstream of the railroad bridge. Loma Alta Creek (Figure 1.2) is the main tributary to the slough and extends about seven miles inland. Commonly, because the slough looks and acts more like a river system, the entire reach of Loma Alta, including the slough, is referred to as Loma Alta Creek. The focus area for this study is the lower 400-m reach and will be referred to as Loma Alta Slough in this document. References to the entire main stem of the creek, including to the slough, will be referred to as Loma Alta Creek.

Loma Alta Slough receives freshwater inflows from the watershed (Figure 1.1 and Figure 1.2), which extends from the mouth of the slough upstream and encompasses approximately 25.4 sq. km. Freshwater runoff is highly seasonal and generally associated with incoming Pacific storms. In general, the wet season runs from about October to April with the rest of the year as dry season. Stream gauge data collected at the Mass Emission Station (MES; Figure 1.2) in the slough shows that the freshwater inflows are generally low, less than 1 cfs during the dry season, whereas inflows generally range from 20 to several hundred cfs during the wet season, and large storms can generate river runoff inflow as high as 600-700 cfs. In addition to receiving seasonal freshwater inflows, the slough flow is also influenced by the flux and exchange of the ocean water through the ocean inlet (Figure 1.2).

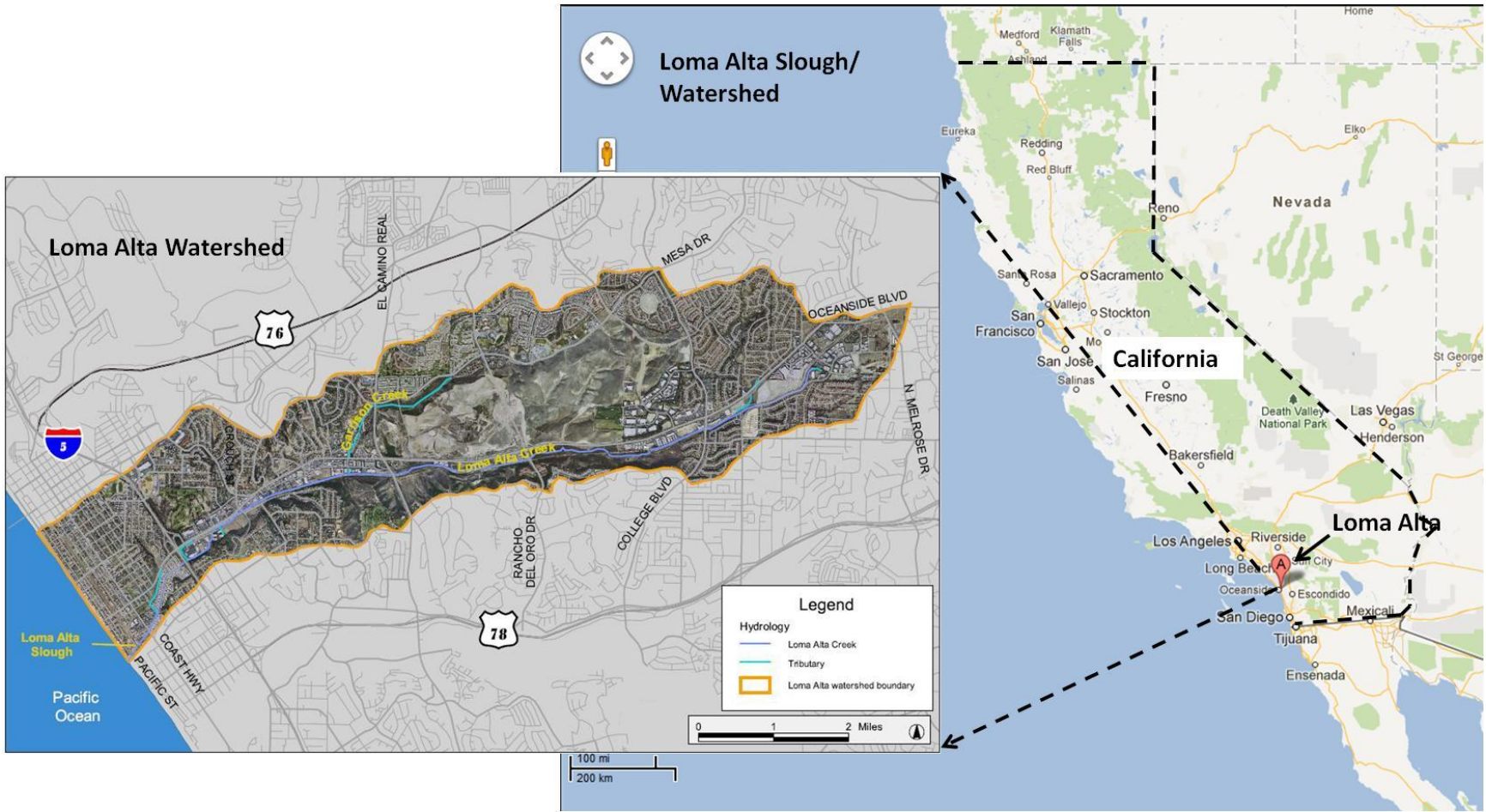
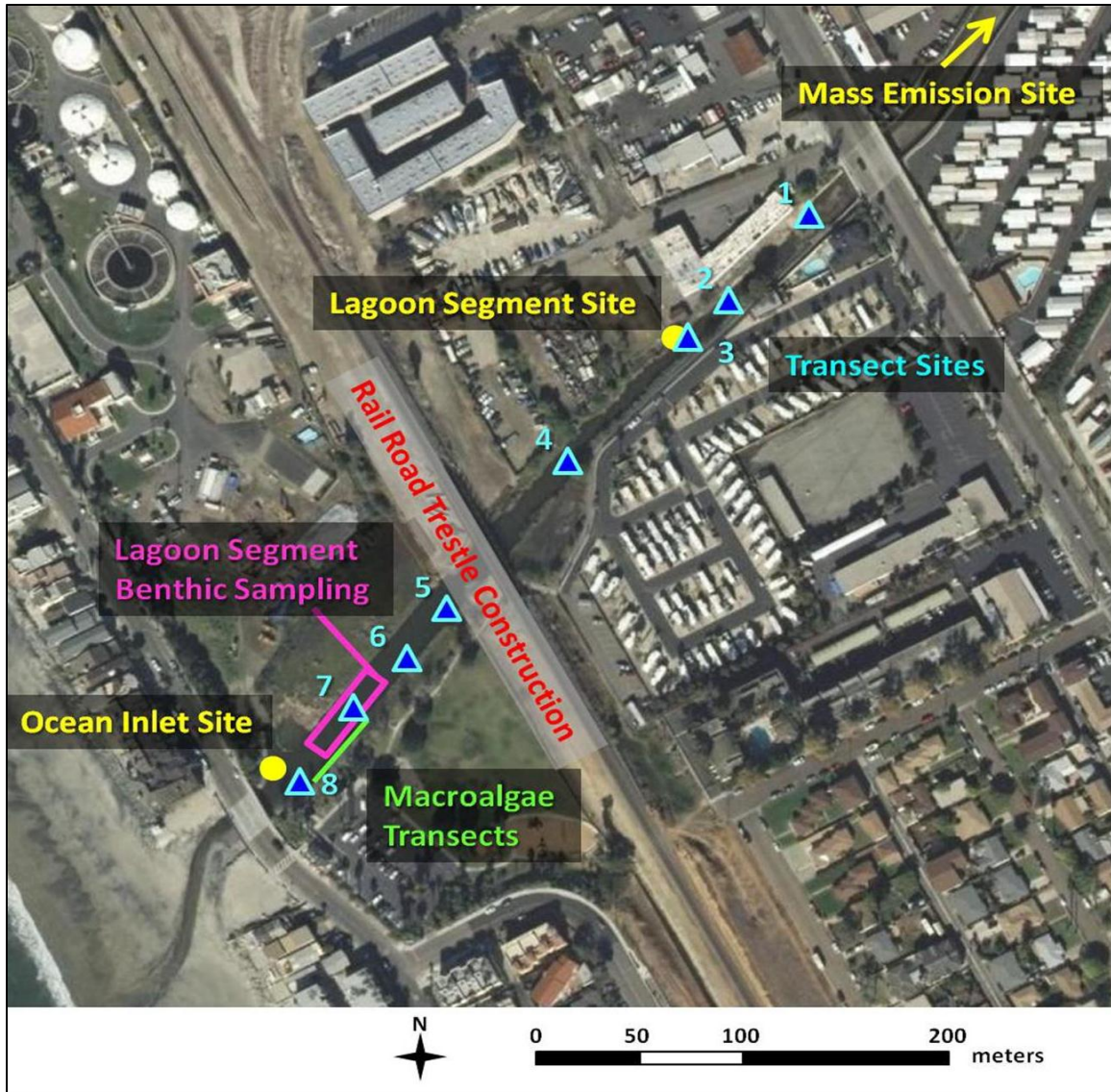


Figure 1.1. Location map for the Loma Alta Slough and watershed in southern California.



**Figure 1.2. Detail map of Loma Alta Slough (or Lagoon) showing inlet to the ocean and the location of sampling stations.**

Complex natural sediment transport and morphological changes take place year round in the slough and, in particular, near the ocean inlet, where the slough interacts with the ocean water when the inlet is open. During the wet season (Oct-Apr), the inlet generally remains open, but closes intermittently in highly irregular cycles. In general, this opening and closing of the inlet is influenced by the river flow dynamics from the storms and the beach sand movement. Observations from local residents suggest that the inlet could remain open for a few days after storms, and then becomes closed by the sand berms formed by natural accumulation of sand from the ocean, which was reinforced by construction by the City of Oceanside. The exact timing and nature of the closing and opening during the wet season is variable. Local observations of the mouth dynamics illustrate that in the beginning of the wet season, the mouth can open and

shut, but once the groundwater table rises due to repeated precipitation, it flows consistently until the beginning of the dry weather season (A. Witheridge, personal communication). It is clear that, during the seasons, the slough water intermittently exchanges with the ocean through channels generated by the complex dynamics of sand/sediment transport. During the dry season from May-Oct, the inlet naturally closes as flows from the watershed are reduced and tidal action causes the natural build-up of the sand berm. Inlet closing results in stagnation of the slough flows and degradation of the water quality, and in particular, enhancement of eutrophication in the slough. During this period, the slough is like a pond with excessive nutrient loads and elevated summer water temperatures, which produce favorable conditions for eutrophication and resulting degradation of water quality in the slough. On the north side of the slough, the City manages a UV treatment facility that withdraws water via a pump from a downstream location of the slough processes it through the UV facility, and discharges the treated water to the Pacific Ocean south of Buccaneer Beach. The facility began operation in 2009. The treatment is variable during the summer as it depends on the flow coming from the watershed. Regularly there is not enough flow to keep the pumps running continuously.

## **1.2 Modeling Approach**

Hydrodynamic and water quality models have become important tools in aiding decisions about water quality management. Models provide the ability to evaluate water quality under a range of expected conditions, to establish loadings required to meet water quality criteria, to evaluate potential management scenarios, and to identify key knowledge gaps to focus future monitoring and research. For this study, watershed loading, hydrodynamic transport, and estuary water quality models were linked to establish nutrient and bacteria TMDLs, and to evaluate potential management scenarios. An integrated modeling approach was developed to investigate the relationships between the bacteria, eutrophication, and the pollutant loads received from the watershed. The watershed model, Hydrological Simulation Program in Fortran (HSPF), was used to simulate freshwater inflows and pollutant loads from the watershed for the period from 10/1/2007 through 10/31/2008. The inflows and loads from HSPF were used as input to the Environmental Fluid Dynamics Code (EFDC) model, which was configured to simulate the hydrodynamics and transport of water and bacteria for the 400-m stretch of the Slough. The simulated hydrodynamics was stored in a link file (LomaAlta.hyd) that links to WASP7.4, which was then used to simulate the water quality and eutrophication condition of the river.

This report summarizes the application of this integrated model to Loma Alta Slough including: 1) the methods and results of calibration and validation of the Loma Alta Creek watershed loading, and estuary hydrodynamic and water quality models for bacteria and nutrients and 2) the results of management scenario analyses conducted to assist stakeholders in their consideration of implementation scenarios.

## 2 WATERSHED LOADING MODEL CALIBRATION AND VALIDATION

This section summarizes the development, calibration, and validation of the watershed loading model for the Loma Alta Slough watershed. This includes identification and description of the watershed characteristics and types of data that were utilized for the model, as well as the approach that was followed for constructing, calibrating, and verifying the hydrologic model for the Loma Alta Slough watershed.

### 2.1 Methods

#### 2.1.1 Data Sources to Support Model Development

The physical, watershed, meteorological, and hydrological data that were utilized to support hydrologic simulation of the Loma Alta Slough watershed are summarized below.

##### Physical Data

Physical watershed-specific data relevant to hydrologic model deployment were obtained from Geographic Information Systems (GIS) databases, field observations, and engineering specifications. The Environmental Systems Research Institute, Inc. (ESRI) ArcGIS and ArcView GIS software packages were utilized for mapping and evaluation of GIS data at multiple scales. Physical watershed-specific data for the Loma Alta Slough watershed, in a GIS ready format, were obtained from:

1. A United States Geological Survey (USGS) 10-m resolution National Elevation Dataset Digital Elevation Model (DEM) (Figure 2.1) SANDAG Land Use and Land Cover (LULC) data representative of watershed land surface conditions for approximately 2009 (Figure 2.2). The LULC data shown in Figure 2.1 are for the delineated Loma Alta Slough watershed area.
2. The Soil Survey Geographic (SSURGO) database for San Diego County, California (
3. Figure 2.3). The soils data shown in
4. Figure 2.3 are for the delineated Loma Alta Slough watershed area.

##### Meteorological Data

The meteorological time series data requirements for the hydrologic model included precipitation and potential evapotranspiration. Observed precipitation data, collected at the mass emission station (see Figure 2.1 through

Figure 2.3 for the location of the mass emission station (black dot) relative to the delineated Loma Alta Slough watershed) was provided by SCCWRP. The period of record for the observed precipitation data set was 10/01/2007 00:30:00 through 10/31/2008 12:30:00. Observed hourly precipitation data for CIMIS (The California Irrigation Management Information System, <http://www.cimis.water.ca.gov/cimis/welcome.jsp>) stations 150 and 173 (see Figure 2.4) were also collected for the period January 2007 through October 2007. Daily maximum temperature, minimum temperature, dew point temperature, wind movement, and solar radiation data was



collected for calendar years 2007 through 2009 for CIMIS stations 147, 150, 153, 173, and 184 (see Figure 2.4).

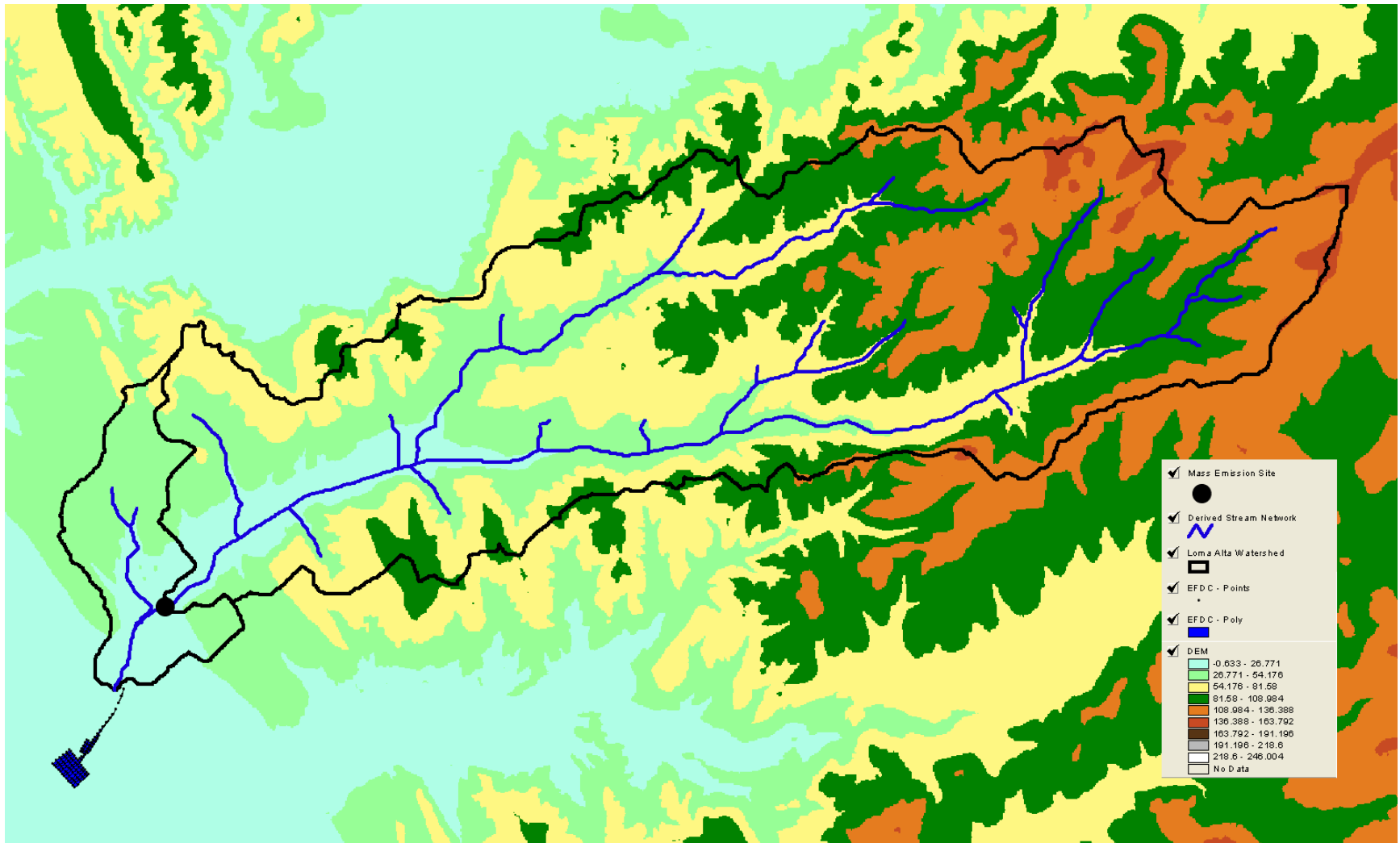


Figure 2.1. Digital Elevation Model (DEM) used for the Loma Alta Slough watershed hydrologic model.

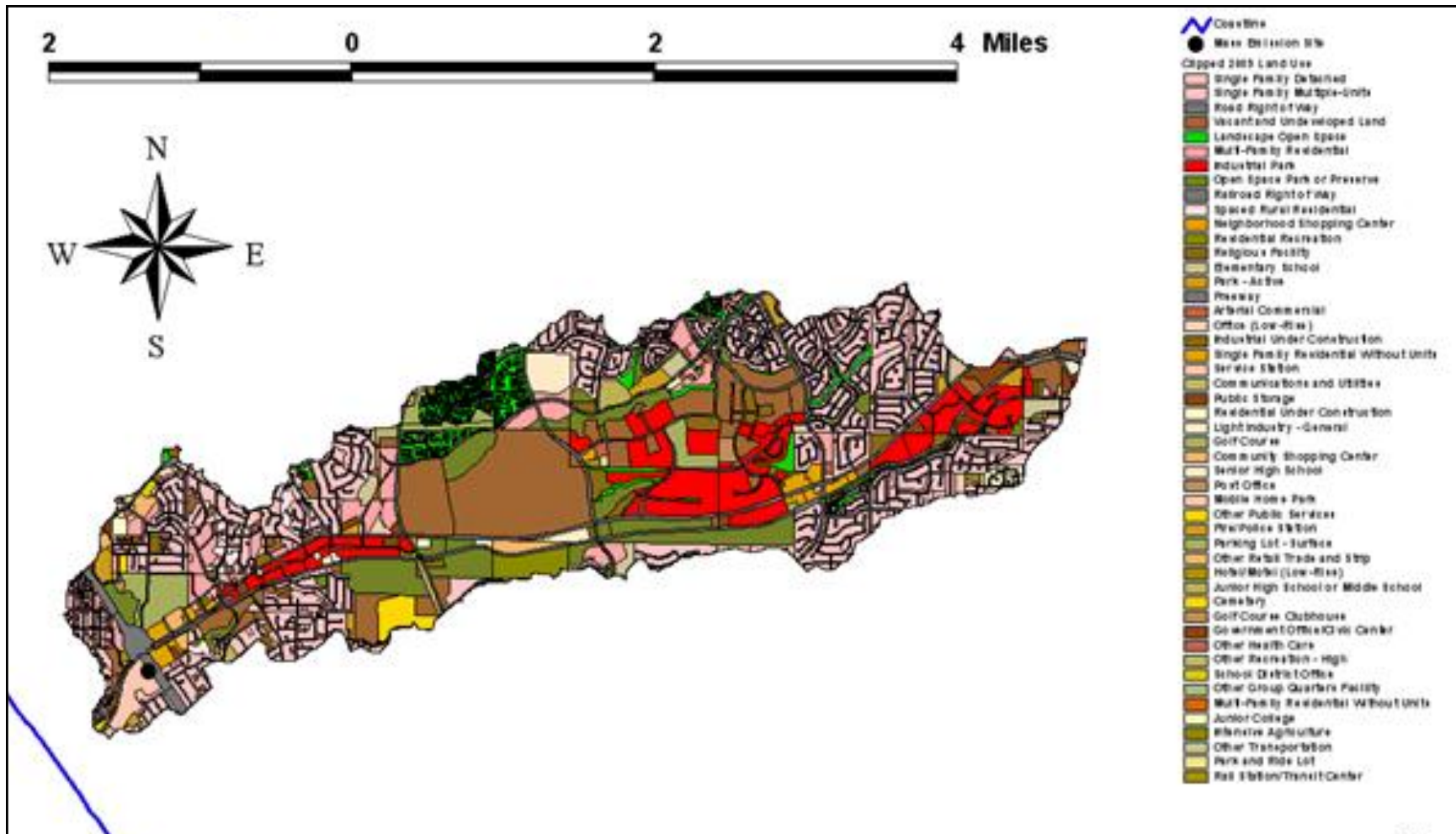


Figure 2.2. SANDAG 2009 LULC data, clipped to the delineated area of the Loma Alta Slough watershed.

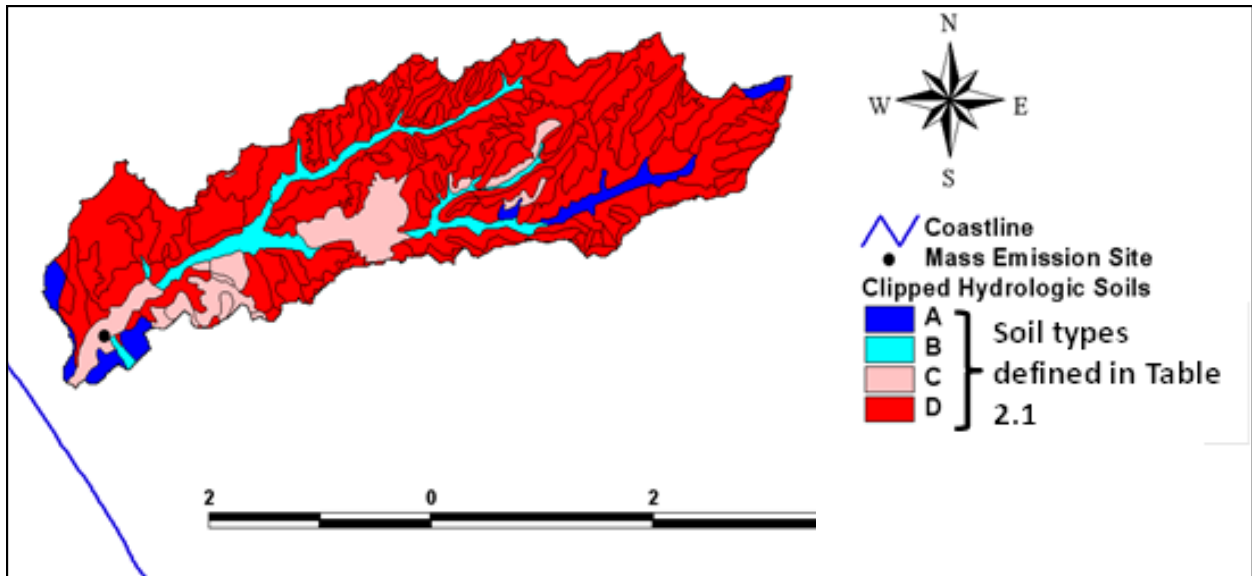


Figure 2.3. SSURGO hydrologic soils group data, clipped to the delineated Loma Alta Slough watershed.

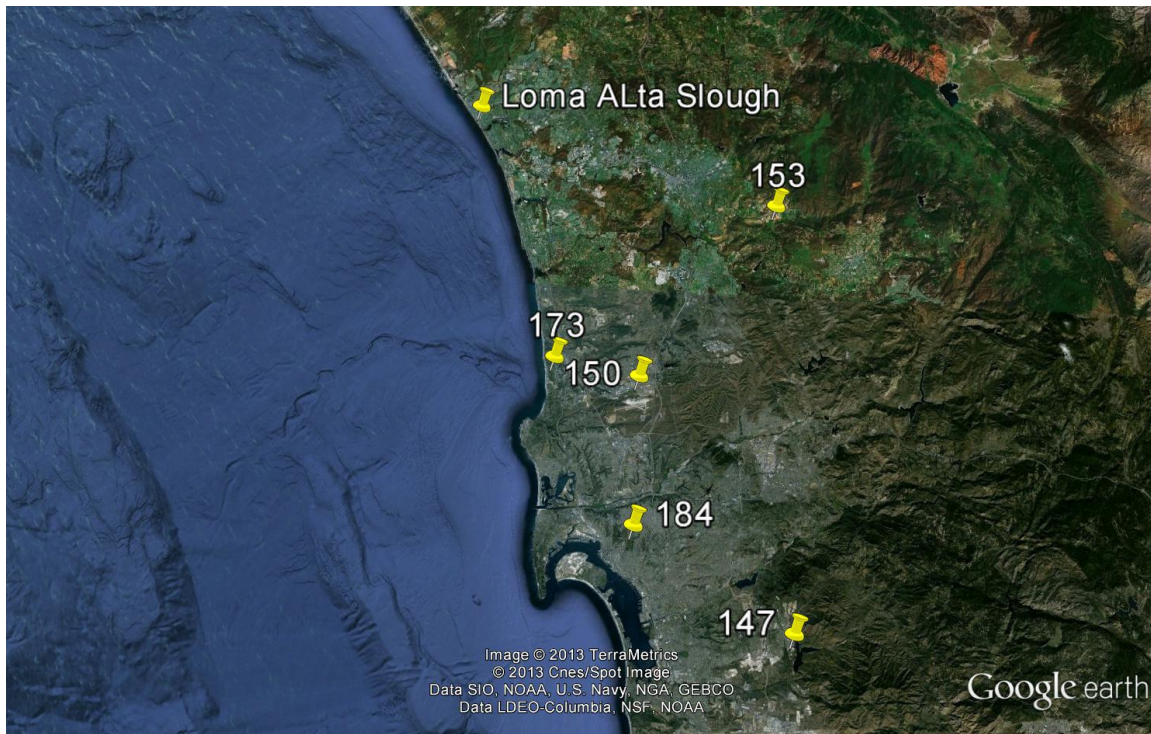


Figure 2.4. Location of CIMIS stations 150 and 173 relative to the Loma Alta Slough.

### Hydrological Data

Data required to calibrate and verify processes simulated by a hydrological model are summarized below. Model calibration and verification data were not used as input to the hydrological model, but rather were used to support parameter estimation, evaluation of model performance, and prediction.

**Stream Discharge Data.** Observed stream discharge data, collected at the mass emission station (see Figure 2.1 through

Figure 2.3 for the location of the mass emission station relative to the delineated Loma Alta Slough watershed), was provided by SCCWRP. The period of record for this observed stream discharge data set was 10/01/2007 00:00:00 through 10/31/2008 23:00:00.

**Literature Search.** A literature search was conducted to identify additional data, beyond the observed stream discharge data, that could be used to improve the calibration and validation of the hydrological model for the Loma Alta Slough watershed.

**Hydrological Response.** The San Diego Hydrology model was identified as a source of additional (synthetic) data set for hydrological model validation. In particular, the San Diego Hydrology Model parameter set provided a basis for the creation of multiple model simulated synthetic datasets related to the partition of precipitation at the land surface (viz., summed direct surface runoff, interflow runoff, base flow runoff, and evapotranspiration for the period 10/01/2007 through 10/31/2008) for uniquely defined pervious and impervious land areas represented within the Loma Alta Slough watershed. Within the San Diego Hydrology Model documentation, preferred parameter values are explicitly specified for sixty pervious land area types and seventeen impervious land area types. The sixty pervious land area types are a function of land use and land cover, soils, and percent slope; whereas, the seventeen impervious land area types are a function of land use and land cover and percent slope. In particular, Table 2.1 and 2.2 list the sixty pervious land area types and seventeen impervious land area types expressed in the San Diego Hydrology Model.

**Table 2.1. SDHM pervious land types (PERLND = pervious land area).**

PERLND No.	Soil	Vegetation/Surface	Slope
1	A	Forest	Flat (0-5%)
2	A	Forest	Moderate (5-10%)
3	A	Forest	Steep (10-20%)
4	A	Forest	Very Steep (>20%)
5	A	Shrub	Flat (0-5%)
6	A	Shrub	Moderate (5-10%)
7	A	Shrub	Steep (10-20%)
8	A	Shrub	Very Steep (>20%)
9	A	Grass	Flat (0-5%)
10	A	Grass	Moderate (5-10%)
11	A	Grass	Steep (10-20%)
12	A	Grass	Very Steep (>20%)
13	A	Dirt	Flat (0-5%)

PERLND No.	Soil	Vegetation/Surface	Slope
14	A	Dirt	Moderate (5-10%)
15	A	Dirt	Steep (10-20%)
16	A	Dirt	Very Steep (>20%)
17	A	Urban	Flat (0-5%)
18	A	Urban	Moderate (5-10%)
19	A	Urban	Steep (10-20%)
20	A	Urban	Very Steep (>20%)
21	B	Forest	Flat (0-5%)
22	B	Forest	Moderate (5-10%)
23	B	Forest	Steep (10-20%)
24	B	Forest	Very Steep (>20%)
25	B	Shrub	Flat (0-5%)
26	B	Shrub	Moderate (5-10%)
27	B	Shrub	Steep (10-20%)
28	B	Shrub	Very Steep (>20%)
29	B	Grass	Flat (0-5%)
30	B	Grass	Moderate (5-10%)
31	B	Grass	Steep (10-20%)
32	B	Grass	Very Steep (>20%)
33	B	Dirt	Flat (0-5%)
34	B	Dirt	Moderate (5-10%)
35	B	Dirt	Steep (10-20%)
36	B	Dirt	Very Steep (>20%)
37	B	Urban	Flat (0-5%)
38	B	Urban	Moderate (5-10%)
39	B	Urban	Steep (10-20%)
40	B	Urban	Very Steep (>20%)
41	C/D	Forest	Flat (0-5%)
42	C/D	Forest	Moderate (5-10%)
43	C/D	Forest	Steep (10-20%)
44	C/D	Forest	Very Steep (>20%)
45	C/D	Shrub	Flat (0-5%)
46	C/D	Shrub	Moderate (5-10%)
47	C/D	Shrub	Steep (10-20%)
48	C/D	Shrub	Very Steep (>20%)
49	C/D	Grass	Flat (0-5%)
50	C/D	Grass	Moderate (5-10%)
51	C/D	Grass	Steep (10-20%)
52	C/D	Grass	Very Steep (>20%)
53	C/D	Dirt	Flat (0-5%)
54	C/D	Dirt	Moderate (5-10%)
55	C/D	Dirt	Steep (10-20%)
56	C/D	Dirt	Very Steep (>20%)
57	C/D	Urban	Flat (0-5%)
58	C/D	Urban	Moderate (5-10%)
59	C/D	Urban	Steep (10-20%)
60	C/D	Urban	Very Steep (>20%)

**Table 2.2. SDHM impervious land types (IMPLND = impervious land area).**

IMPLND No.	Surface	Slope
1	Roads	Flat (0-5%)
2	Roads	Moderate (5-10%)
3	Roads	Steep (10-20%)
4	Roads	Very Steep (>20%)
5	Roof Area	All
6	Driveways	Flat (0-5%)
7	Driveways	Moderate (5-10%)
8	Driveways	Steep (10-20%)
9	Driveways	Very Steep (>20%)
10	Sidewalks	Flat (0-5%)
11	Sidewalks	Moderate (5-10%)
12	Sidewalks	Steep (10-20%)
13	Sidewalks	Very Steep (>20%)
14	Parking	Flat (0-5%)
15	Parking	Moderate (5-10%)
16	Parking	Steep (10-20%)
17	Parking	Very Steep (>20%)

### Water Quality Data

Data required to calibrate and verify water quality processes simulated by the watershed model are summarized below. Model calibration and verification data were used to support parameter estimation, evaluation of model performance, and prediction.

Ideally in a watershed water quality modeling application, data are collected from small catchments within the watershed to reflect the pollutant export from individual land uses. That data is used to calibrate the model. The model is then validated against data collected from a much larger area, integrating the runoff from multiple land uses. In this study, data was only available from a single mass emission monitoring point at the bottom of the watershed; no other data on the catchment scale were available. This necessitated that data from other sources be identified to characterize the land use runoff conditions.

**Mass Emission Monitoring.** Three storms were monitored during 2008 at the mass emission station in the Loma Alta Slough by Mactec Engineering & Consulting, Inc. (Mactec). Eight to 12 individual pollutograph samples were taken throughout the course of a storm so that a characteristic event mean concentration was calculated for each constituent for each storm. The monitoring methods and results of those efforts are detailed in Mactec (2009). The EMC bacteria and nutrient concentration for each of the three monitored storms are shown in Table 2.3. Daily loading data for Enterococcus, fecal coliform, and total coliform, in G-org (Giga ( $10^9$ )-Organisms) unit and associated with the mass emission station (see Figure 2.1 through

Figure 2.3 for the location of the mass emission station relative to the delineated Loma Alta Slough watershed), was obtained from Appendix D-3 of the CHU Lagoon Monitoring Report dated June 2009 prepared by Mactec. The period of record for the daily loading data sets was 11/01/2007 through 10/31/2008.

**Table 2.3. Loma Alta Slough mass emission monitoring results.**

Parameter	1/7/2008	1/24/2008	2/3/2008	Average
Enterococcus (CFU/100mL)	21,712	11,862	13,000	15,525
Fecal Coliform (MPN/100mL)	9,273	29,658	1,700	13,544
Total Coliform (MPN/100mL)	55,021	86,468	35,000	58,830
Ammonia (mg L <sup>-1</sup> )	0.10	0.12	0.45	0.22
Nitrate-Nitrite (mg L <sup>-1</sup> )	0.61	0.48	0.27	0.45
Total Nitrogen (mg L <sup>-1</sup> )	1.40	1.28	No Data	1.34
Dissolved Phosphorous (mg L <sup>-1</sup> )	0.29	0.17	0.19	0.22
Phosphorous (mg L <sup>-1</sup> )	0.38	0.23	0.30	0.30

**Land Use Runoff Characterization.** Because of the paucity of land use monitoring data in the Loma Alta Slough watershed, data from other sources were used to characterize the land use runoff. Land use monitoring from the regional stormwater monitoring programs has been characterized by Ackerman and Schiff (2003). In that study, land use monitoring throughout southern California were compiled with 10<sup>th</sup> percentile, median, and 90<sup>th</sup> percentile concentrations calculated for broad land use categories (Error! Not a valid bookmark self-reference.4).

Not all of the nutrient species were analyzed in the land use monitoring. Relationships between total nitrogen and nitrite-nitrate and total dissolved phosphorous and total phosphorous and phosphate are empirically developed (



Table 2.4). These relationships were used to define the characteristic stormwater bacteria concentration from each land use type (Table 2.5).

**Table 2.4. Stormwater nutrient noncentration from land uses in Ackerman and Schiff (2003) and Sengupta et al. (in review).**

Land Use Type	TN (mg L <sup>-1</sup> )	TP (mg L <sup>-1</sup> )	Ammonia (mg L <sup>-1</sup> )	Nitrate (mg L <sup>-1</sup> )	Phosphate (mg L <sup>-1</sup> )
<b>Agriculture</b>	10.41	11.30	1.34	7.31	3.27
<b>Commercial</b>	3.56	0.56	0.45	1.30	0.09
<b>Industrial</b>	3.55	1.33	0.34	1.29	0.32
<b>Open</b>	2.46 <sup>a</sup>	0.35 <sup>b</sup>	0.04	0.34	0.03
<b>Residential</b>	3.96	1.10	0.42	1.65	0.25

**Table 2.5. Stormwater bacteria concentrations from land uses.**

Land Use	Concentration (Count 100 ml <sup>-1</sup> )		
	Fecal Coliform	Total Coliform	Enterococcus
Agriculture	13,381	80,292	93,664
Commercial	13,477	80,868	94,336
High Density Residential	80,858	166,026	67,383
Industrial	1,063	7,012	3,394
Low Density Residential	9,403	23,389	30,702
Open	25	609	81
Open-Recreational	8,446	21,994	27,557
Transportation	2,115	8,261	4,127

### *2.1.2 Processing of Time Series Data*

#### *Precipitation Data*

The observed precipitation data collected at the mass emission station (see Figure 2.1 through Figure 2.3 for the location of the mass emission station relative to the delineated Loma Alta Slough watershed) were provided by SCCWRP. The data had to be processed into a usable format by interpolating the original data to a continuous record at an hourly time step and then subsequently further processed to interface the data with the watershed model to support simulation. The public domain time series processor TSPROC (see Doherty 2004) was used to interpolate the precipitation accumulation data. The precipitation accumulation data were subsequently differenced to create precipitation rate data and converted from millimeters to inches during the process. A final step was performed to verify that the processed continuous hourly precipitation data yielded the same summary values as expressed in Table 4-44 in the June 2009 Mactec report. While monthly totals were the same, there were some minor discrepancies with daily totals which were attributed to the interpolation process.

The average hourly precipitation rate was computed using the hourly precipitation data from CIMIS stations 150 and 173 for the period 01/01/2007 00:00:00 through 10/01/2007 12:00:00. Combining this hourly precipitation dataset with the processed continuous hourly precipitation data associated with the mass emission station allowed for watershed simulation at an hourly time step for the period 01/01/2007 through 10/31/2008.

#### *Evaporation Data*

The daily maximum temperature, minimum temperature, dew point temperature, wind movement, and solar radiation data collected for calendar years 2007 through 2009 for CIMIS stations 147, 150, 153, 173, and 184 (see Figure 2.4) were processed into a single representative station to accommodate the fact that each of the datasets contained missing data records and the watershed model requires complete and continuous records. Subsequently, the processed daily maximum temperature, minimum temperature, mean dew point temperature, mean wind speed, and solar radiation data were utilized to compute Penman pan evaporation rates for the period January 1, 2007 through December 31, 2009

using the public domain data processing WDMUtil software system. WDMUtil was subsequently used to disaggregate the computed daily Penman pan evaporation data to an hourly time step.

### Stream Discharge Data

The observed stream discharge data collected at the mass emission station (see Figure 2.1 through Figure 2.3 for the location of the mass emission station relative to the delineated Loma Alta Slough watershed) and provided by SCCWRP was interpolated to an hourly time step using the public domain time series processor TSPROC (Doherty 2004). Discharge totals at the monthly and daily time scale were compared with those reported in Table 4-45 in the June 2009 Mactec report. As with the processed precipitation data comparisons, the differences were relatively minor and were attributed to the interpolation.

Plots of the original (i.e., as provided) observed stream discharge data (see Figure 2.5) showed that observed flows during the dry weather (base flow) maintained at 1 to 2 cfs levels with some oscillations throughout the period. These dry weather base flow rates measured during the dry weather (no rain within 48 hours) posed problems when they were compared with other independent data. First, the watershed model predicted much lower flow rates (~0.01 cfs) during the corresponding dry weather period, although the watershed model is only designed to simulate wet weather flow rates. Second, and most importantly, the watershed flows, including the dry weather flow rate, were used to drive and calibrate the receiving water hydrodynamic and eutrophication model. As discussed in detail in Section 3.1, watershed flow rate was calibrated to maintain a base flow at 0.495 cfs during the dry weather period. Due to these inconsistencies associated with measured dry weather flow rates, it was suspected that the flow rates measured during dry weather in 2008 were potentially erroneous. As such, flow rates during July-August 2011 (representative of dry weather) were measured using a new set of flow gauge. The average dry weather flow rate during the two months was 0.495 cfs, exactly the same as what the calibration of the hydrodynamic model produces.

**Hydrologic Response Data.** Upon completion of watershed model development (see Section 4), a simulation was performed using the SDHM parameter set, and simulated direct surface runoff (SURO), interflow runoff (IFWO), base flow runoff (AGWO), and evapotranspiration (TAET) were saved for each of SDHM's sixty pervious land area and seventeen impervious land area types that were appropriately represented into the final Loma Alta Slough watershed model. The processing and management of this hydrologic response data was performed using the public domain time series data processor TSPROC (see Doherty 2004 for details about TSPROC). The TSPROC input data file that was prepared in part to process and manage the synthetic model simulated observations that were used to supplement the model calibration is provided in Appendix 1.

Error! Reference source not found. **Figure 2.5. Plot of observed stream discharge data associated with mass emission station. Top and bottom panels represent different months as examples of flow patterns.**

### 2.1.3 Methodology to Develop and Calibrate Hydrologic Model

#### Model Development

Relevant features of the development process for the hydrologic model that was developed for the Loma Alta Slough watershed are summarized below.

**Basin Delineation.** The deterministic eight-neighbor digital elevation model processing algorithm TOPAZ (for Topographic Parameterization), as encapsulated in the Watershed Modeling System, was utilized to delineate the Loma Alta Slough watershed using the 10-m resolution digital elevation model. The delineated watershed and derived stream network, both obtained using WMSTOPAZ, are shown in Figure 2.5. As indicated in Figure 2.5, the Loma Alta Slough watershed was discretized into two sub-basins, with the upper basin draining to the mass emission station, and the main basin outlet just upstream of the EFDC hydrodynamic model grid.

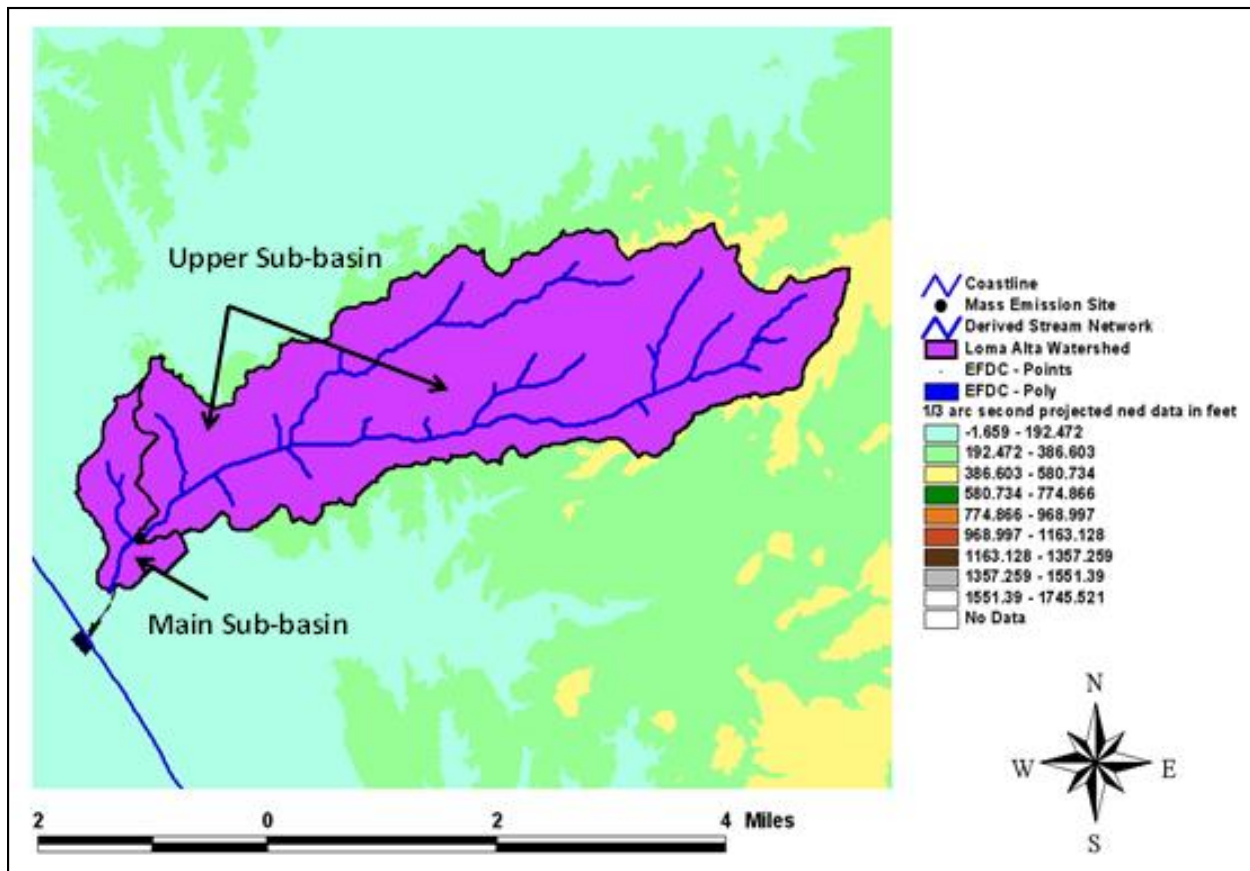


Figure 2.5. Delineated Loma Alta Slough watershed and derived stream network.

**Landscape Features.** Based on the SDHM parameter set, landscape features incorporated into the model included a cross product of a remapping of the 2009 SANDAG land use and land cover data (see Figure 2.2) to the SDHM vegetation/surface types, hydrologic soils group data (see

Figure 2.3), and percent slope (see

Figure 2.6). This product was determined using GIS analysis. The remapping of the 2009 SANDAG land use and land cover data (see Figure 2.2) to the SDHM vegetation/surface types is summarized in Table 2.6. The remapped pervious and impervious land cover areas for the Loma Alta Slough watershed drainage area above the mass emission station and for the remaining drainage area below the mass emission station and above the main basin outlet located at the most upstream point of the EFDC model grid are presented in Table 2.7 and 2.8. With the watershed model, IMPLND area refers to directly connected impervious land area. To account for the potential overestimation of IMPLND roof area, a simple multiplicative parameter for reducing its total area within each of the two modeled sub-watersheds was employed, and the reduced roof area was then increased for the urban landscaped vegetation types, distributed to those PERLND types based on their originally determined distribution in each sub-basin.

Stage-discharge relationships for the reach within each delineated sub-watershed were specified based on application of Manning's equation and information encapsulated in BASINS Technical Note 1 ([http://water.epa.gov/scitech/datait/models/basins/upload/2009\\_04\\_13\\_BASINSs\\_tecnote1.pdf](http://water.epa.gov/scitech/datait/models/basins/upload/2009_04_13_BASINSs_tecnote1.pdf)).

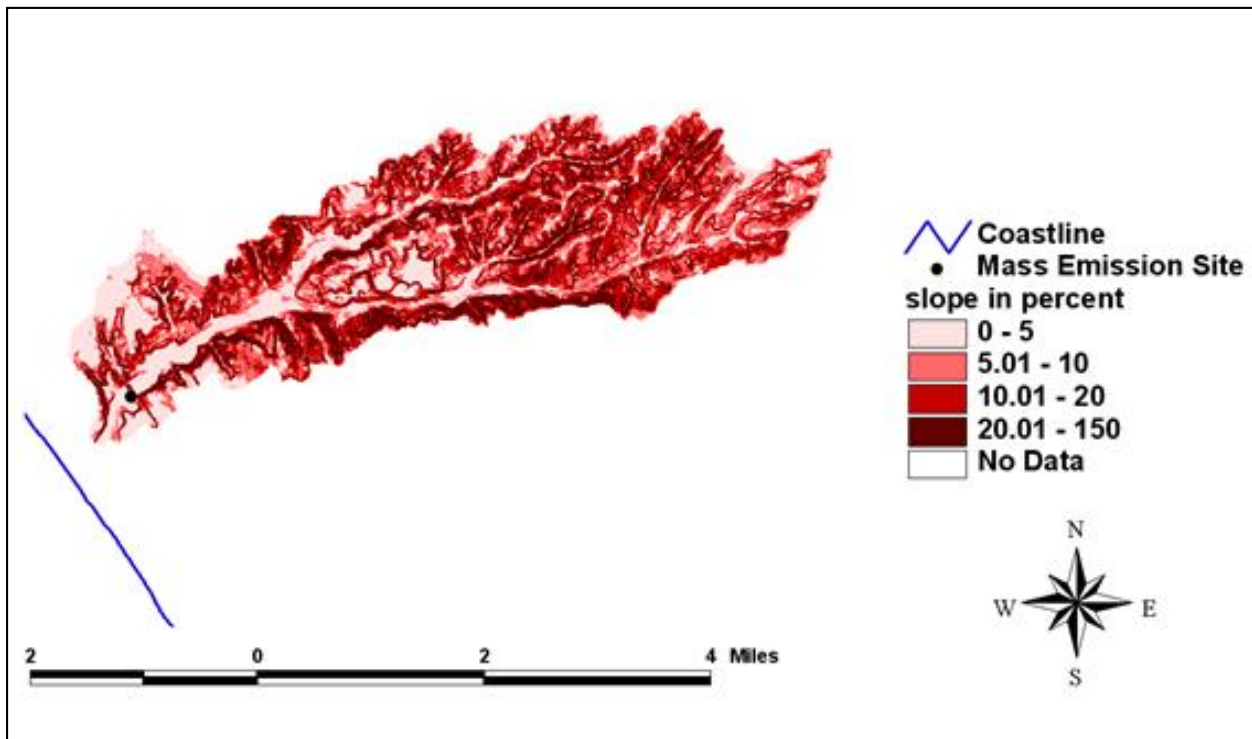


Figure 2.6. Percent slope derived from 10-m resolution DEM for the Loma Alta watershed.



Table 2.6. Mapping from 2009 SANDAG LULC data to SDHM vegetation/surface types.

SANDAG GIS 2009 Landuse Data	SDHM LU Classifications - %s									
	PERLNDS					IMPLNDS				
	natural vegetation			urban veg.						
	Forest	native shrub	non-turf grass	Dirt	Urban landscaped veg. (lawns, flowers, planted shrubs and trees)	Roads	Roof area	Driveways	Sidewalks	Parking
LANDUSE										
Mobile Home Park	0.00%	0.00%	0.00%	0.00%	20.00%	10.00%	50.00%	10.00%	10.00%	0.00%
Single Family Detached	0.00%	0.00%	0.00%	0.00%	30.00%	0.00%	65.00%	5.00%	0.00%	0.00%
Road Right of Way	0.00%	0.00%	0.00%	0.00%	0.00%	100.00%	0.00%	0.00%	0.00%	0.00%
Vacant and Undeveloped Land	0.00%	50.00%	0.00%	50.00%	0.00%	0.00%	0.00%	0.00%	0.00%	0.00%
Single Family Multiple-Units	0.00%	0.00%	0.00%	0.00%	15.00%	0.00%	70.00%	5.00%	5.00%	5.00%
Park - Active	0.00%	0.00%	0.00%	10.00%	65.00%	0.00%	5.00%	0.00%	5.00%	15.00%
Communications and Utilities	0.00%	0.00%	0.00%	10.00%	30.00%	10.00%	40.00%	0.00%	0.00%	10.00%
Other Transportation	0.00%	0.00%	0.00%	0.00%	0.00%	0.00%	50.00%	0.00%	0.00%	50.00%
Multi-Family Residential	0.00%	0.00%	0.00%	0.00%	5.00%	0.00%	70.00%	0.00%	5.00%	20.00%
Freeway	0.00%	0.00%	0.00%	0.00%	0.00%	100.00%	0.00%	0.00%	0.00%	0.00%
Other Public Services	0.00%	0.00%	0.00%	0.00%	20.00%	0.00%	50.00%	0.00%	0.00%	30.00%
Multi-Family Residential Without Units	0.00%	33.34%	33.33%	33.33%	0.00%	0.00%	0.00%	0.00%	0.00%	0.00%
Single Family Residential Without Units	0.00%	33.34%	33.33%	33.33%	0.00%	0.00%	0.00%	0.00%	0.00%	0.00%
Other Group Quarters Facility	0.00%	0.00%	0.00%	0.00%	20.00%	0.00%	50.00%	0.00%	5.00%	25.00%
Hotel/Motel (Low-Rise)	0.00%	0.00%	0.00%	0.00%	5.00%	0.00%	65.00%	0.00%	0.00%	30.00%
Service Station	0.00%	0.00%	0.00%	0.00%	5.00%	0.00%	70.00%	0.00%	0.00%	25.00%
Railroad Right of Way	0.00%	0.00%	0.00%	25.00%	75.00%	0.00%	0.00%	0.00%	0.00%	0.00%
Elementary School	0.00%	0.00%	0.00%	0.00%	20.00%	0.00%	50.00%	0.00%	5.00%	25.00%
Other Retail Trade and Strip	0.00%	0.00%	0.00%	0.00%	5.00%	0.00%	70.00%	0.00%	0.00%	25.00%
Cemetery	0.00%	0.00%	0.00%	0.00%	80.00%	10.00%	0.00%	0.00%	0.00%	10.00%
Senior High School	0.00%	0.00%	0.00%	0.00%	20.00%	0.00%	50.00%	0.00%	5.00%	25.00%
Industrial Park	0.00%	0.00%	0.00%	0.00%	10.00%	0.00%	65.00%	0.00%	0.00%	25.00%
Public Storage	0.00%	0.00%	0.00%	0.00%	0.00%	20.00%	75.00%	0.00%	0.00%	5.00%
Light Industry - General	0.00%	0.00%	0.00%	0.00%	10.00%	0.00%	65.00%	0.00%	0.00%	25.00%
Rail Station/Transit Center	0.00%	0.00%	0.00%	0.00%	20.00%	0.00%	60.00%	0.00%	0.00%	20.00%
Open Space Park or Preserve	0.00%	50.00%	10.00%	40.00%	0.00%	0.00%	0.00%	0.00%	0.00%	0.00%
Arterial Commercial	0.00%	0.00%	0.00%	0.00%	5.00%	0.00%	85.00%	0.00%	5.00%	5.00%
Residential Recreation	0.00%	0.00%	0.00%	0.00%	65.00%	0.00%	20.00%	0.00%	5.00%	10.00%
Spaced Rural Residential	0.00%	0.00%	0.00%	0.00%	25.00%	0.00%	70.00%	5.00%	0.00%	0.00%
Landscape Open Space	0.00%	0.00%	0.00%	0.00%	100.00%	0.00%	0.00%	0.00%	0.00%	0.00%
Office (Low-Rise)	0.00%	0.00%	0.00%	0.00%	5.00%	0.00%	65.00%	0.00%	5.00%	25.00%
Community Shopping Center	0.00%	0.00%	0.00%	0.00%	5.00%	0.00%	50.00%	0.00%	5.00%	40.00%
Neighborhood Shopping Center	0.00%	0.00%	0.00%	0.00%	5.00%	0.00%	50.00%	0.00%	5.00%	40.00%
Religious Facility	0.00%	0.00%	0.00%	0.00%	10.00%	0.00%	50.00%	0.00%	5.00%	35.00%
Junior High School or Middle School	0.00%	0.00%	0.00%	0.00%	20.00%	0.00%	50.00%	0.00%	5.00%	25.00%
Other Health Care	0.00%	0.00%	0.00%	0.00%	5.00%	0.00%	65.00%	0.00%	0.00%	30.00%
School District Office	0.00%	0.00%	0.00%	0.00%	5.00%	0.00%	65.00%	0.00%	5.00%	25.00%
Government Office/Civic Center	0.00%	0.00%	0.00%	0.00%	5.00%	0.00%	65.00%	0.00%	5.00%	25.00%
Junior College	0.00%	0.00%	0.00%	0.00%	20.00%	0.00%	50.00%	0.00%	5.00%	25.00%
Fire/Police Station	0.00%	0.00%	0.00%	0.00%	5.00%	0.00%	70.00%	0.00%	5.00%	20.00%
Post Office	0.00%	0.00%	0.00%	0.00%	5.00%	0.00%	70.00%	0.00%	0.00%	25.00%
Park and Ride Lot	0.00%	0.00%	0.00%	0.00%	0.00%	0.00%	0.00%	0.00%	0.00%	100.00%
Other Recreation - High	0.00%	0.00%	0.00%	0.00%	10.00%	0.00%	50.00%	0.00%	5.00%	35.00%
Golf Course	0.00%	0.00%	0.00%	0.00%	100.00%	0.00%	0.00%	0.00%	0.00%	0.00%
Golf Course Clubhouse	0.00%	0.00%	0.00%	0.00%	5.00%	0.00%	60.00%	0.00%	5.00%	30.00%
Residential Under Construction	0.00%	0.00%	0.00%	50.00%	0.00%	0.00%	50.00%	0.00%	0.00%	0.00%
Industrial Under Construction	0.00%	0.00%	0.00%	50.00%	0.00%	0.00%	50.00%	0.00%	0.00%	0.00%
Parking Lot - Surface	0.00%	0.00%	0.00%	0.00%	0.00%	0.00%	0.00%	0.00%	0.00%	100.00%
Intensive Agriculture	0.00%	0.00%	0.00%	50.00%	50.00%	0.00%	0.00%	0.00%	0.00%	0.00%

**Table 2.7. Areas for the unique SDHM Vegetation/Surface types represented in the Loma Alta Slough watershed model for the drainage area above the mass emission station.**

<b>Drainage Area Above Mass Emission Station</b>					
<b>PERLNDS</b>			<b>IMPLNDS</b>		
	sq. ft.	acre		sq. ft.	acre
1	0	0	1	6812240	156.3875
2	0	0	2	9808535	225.173
3	0	0	3	11018214	252.9434
4	0	0	4	4864325	111.6695
5	83409.91	1.914828	5	75716635	1738.215
6	241418.8	5.542213	6	474144.2	10.88485
7	127464.4	2.926181	7	908286.9	20.8514
8	31131.87	0.714689	8	1132730	26.0039
9	7753.597	0.177998	9	713800.8	16.38661
10	15742.15	0.36139	10	435023.8	9.986772
11	13862.49	0.318239	11	404655.5	9.289613
12	5404.022	0.124059	12	390734.3	8.970025
13	112662.1	2.586366	13	224971.8	5.164642
14	331113.8	7.601328	14	3588564	82.3821
15	209640.8	4.812691	15	4136661	94.96468
16	31895.48	0.732219	16	4206914	96.57745
17	286824.3	6.584581	17	2823543	64.81962
18	563956.7	12.94666			
19	466801.8	10.71629			
20	115305.4	2.647047			
21	0	0			
22	0	0			
23	0	0			
24	0	0			
25	1299315	29.82817			
26	546276.1	12.54077			
27	243181	5.582667			
28	181504.7	4.166774			
29	193487.5	4.441862			
30	97977.27	2.249249			
31	44172.01	1.01405			
32	24905.49	0.571751			
33	1242455	28.52285			
34	534234.6	12.26434			
35	266148.1	6.109919			
36	163412.9	3.751445			
37	1061890	24.37765			
38	511972.4	11.75327			
39	379808.8	8.71921			
40	97331.14	2.234415			
41	0	0			
42	0	0			
43	0	0			
44	0	0			
45	4594985	105.4863			
46	5256195	120.6656			
47	7398420	169.8444			
48	7764170	178.2408			
49	111761.4	2.565689			
50	177235.9	4.068778			
51	437686.2	10.04789			
52	751746.5	17.25772			
53	4830765	110.8991			
54	5751543	132.0373			
55	8242680	189.2259			
56	8041714	184.6123			
57	6566533	150.7469			
58	10886168	249.912			
59	15015957	344.7189			
60	8809026	202.2274			



**Table 2.8. Areas for the unique SDHM Vegetation/Surface types represented in the Loma Alta Slough watershed model for the drainage area below the mass emission station and above the main basin outlet located at the most upstream point of the EFDC model grid.**

<b>Drainage Area Above Main Basin Outlet</b>					
<b>PERLNDS</b>			<b>IMPLNDS</b>		
	sq. ft.	acre		sq. ft.	acre
1	0	0	1	2829475	64.95582
2	0	0	2	918566.3	21.08738
3	0	0	3	962855.8	22.10413
4	0	0	4	544161.5	12.49223
5	28195.13	0.647271	5	6626800	152.1304
6	35439.58	0.813581	6	303271.4	6.962153
7	12335.27	0.283179	7	77477.23	1.778632
8	3524.362	0.080908	8	28606.07	0.656705
9	1174.67	0.026967	9	25257.93	0.579842
10	783.1133	0.017978	10	330350.2	7.583798
11	0	0	11	63262.3	1.452303
12	0	0	12	25845.32	0.593327
13	32541.49	0.74705	13	17563.07	0.403193
14	40960.84	0.940332	14	1004502	23.06019
15	15154.76	0.347905	15	149080.5	3.422418
16	5051.586	0.115968	16	113014.5	2.594457
17	632388.1	14.51763	17	39649.08	0.910218
18	237542	5.453214			
19	72131.95	1.655922			
20	26961.37	0.618948			
21	0	0			
22	0	0			
23	0	0			
24	0	0			
25	0	0			
26	0	0			
27	0	0			
28	0	0			
29	0	0			
30	0	0			
31	0	0			
32	0	0			
33	0	0			
34	0	0			
35	0	0			
36	0	0			
37	34186.31	0.78481			
38	2819.49	0.064727			
39	352.4361	0.008091			
40	0	0			
41	0	0			
42	0	0			
43	0	0			
44	0	0			
45	273138.1	6.270387			
46	143911.5	3.303752			
47	203434.2	4.670206			
48	312689.9	7.178372			
49	15507.19	0.355996			
50	20088.86	0.461177			
51	25218.69	0.578941			
52	32737.1	0.75154			
53	338280	7.765841			
54	158655	3.642219			
55	206136	4.73223			
56	308166	7.074518			
57	1662677	38.1698			
58	666868.1	15.30918			
59	615353.6	14.12658			
60	319366	7.331634			

### Methodology for Watershed Hydraulic Loading Model Calibration

The hydrologic model that was developed for the Loma Alta Slough watershed was subsequently interfaced with the model-independent parameter estimation tool PEST (Doherty 2004) to support computer-based model calibration and prediction. The PEST software is comprehensively described in Doherty (2004). An integral part of the watershed model - PEST interface process involved the development of the TSPROC input data file that is presented in Appendix 1. In effect, that file is the basis for characterizing the objection function; viz., the quantitative measure of model to measurement misfit. For the Loma Alta Slough watershed model calibration, the perceptual model was to fit:

1. The hard data (i.e., the observed flow data), and
2. Expectations (based on the SDHM hydrologic model parameter set) for the partition of total summed precipitation for the period 10/01/2007 through 10/31/2008 across direct surface runoff, interflow runoff, base flow runoff, and evapotranspiration for each land use / land cover represented in the model, as noted in Section 4.2.

Due to the errors associated with the observed stream discharge data (see Section 3.3), it was determined that any computer-based model calibration work (or manual for that matter) would have to be based on the identification of specific precipitation-runoff events rather than a simple comparison of a complete continuous section of the observed hydrograph record with its model simulated counterpart. The following events/time periods were identified (based on manual inspection of the observed hydrograph) as a basis for comparing observed stream discharge data with their model simulated counterparts in support of model calibration:

Two hundred and twenty-six additional (synthetic) data observations were also included as part of the objective function for the noted period of 10/01/2007 through 10/31/2008; viz., summed SURO, IFWO, AGWO, and TAET for the forty-eight unique (SDHM-based and defined) PERLNDs represented in the model and SURO and TAET for the seventeen (SDHM-based and defined) IMPLNDs also represented in the Loma Alta Slough watershed model. This resulted in a total of 503 observations for use in the hydrologic calibration process for the Loma Alta Slough watershed.

#### *2.1.4 Methodology to Develop and Validate Watershed Nutrient and Bacteria Loading Model*

##### Model Development

This section discusses the processes that were used to simulate loads of nutrients including ammonia ( $\text{NH}_3$ ), nitrite-nitrate ( $\text{NO}_3\text{-NO}_2$ ), total nitrogen (Total-N), dissolved phosphorous ( $\text{PO}_4$ ), and total phosphorous (Total-P) and bacteria (fecal coliform, total coliform, enterococcus) from the Loma Alta Slough watersheds. The calibrated HSPF hydrology was used to simulate the hydrology of the watershed and the how stormwater transports those constituents to the Slough. Results from the water quality loading model were compared with the observed nutrient and bacteria concentrations measured in the three monitored storms from January and February 2008.

##### Water Quality Model Validation

The water quality model application required a slightly different approach than the hydrologic model. With the hydrologic model, the lands were divided into pervious and impervious areas (with soil type,

slope, etc. characterized). Since water quality varies by land use type, it was necessary to slightly modify how the different land use types were represented (while maintaining the hydrologic calibration). The water quality model simulated eight land use type: agriculture, commercial, high density residential, industrial, low density residential, open, open-recreation, transportation. The percent imperviousness for each of those land uses is shown in Table 2.9

**Table 2.9. Percent imperviousness for the water quality watershed model (Ackerman and Schiff 2003).**

Land Use	Percent Impervious
Agriculture	0
Commercial	90
High Density Residential	90
Industrial	50
Low Density Residential	15
Open	0
Open-Recreational	12
Transportation	95

Because of a paucity of land use stormwater monitoring data in the Loma Alta Slough watershed, a rigorous calibration and validation of the model was not feasible. A weight of evidence approach was selected to maximize the utility of the available data. The water quality model output for each eight land uses simulated 26 years of stormwater runoff (WY1980-2006). The model build up/wash off parameters were adjusted to approximate the observed land use concentrations in the 26 years of model output while maintaining a 30-day maximum build-up rate.

The Loma Alta Slough watershed model was run in a similar manner to the land use calibration to characterize its predictive ability relative to the three monitored storms at the mass emission station. The watershed model simulated the stormwater runoff between WY1980 and 2006. It should be noted that the model was developed only to characterize the surface stormwater runoff water quality and not the base flow conditions.

#### **4.2 Results and Discussion of Watershed Hydraulic Loading Model Calibration and Validation**

A series of PEST inversion runs were carried out to calibrate the Loma Alta Slough watershed model. As previously mentioned, to account for the potential overestimation of IMPLND roof area, a simple multiplicative parameter was specified to allow for reducing its total area within each of the two modeled sub-watersheds, with the reduced IMPLND roof area then increased for the urban landscaped vegetation types, distributed to those PERLND types based on their originally determined distribution in each sub-basin. The first two runs simply involved executing the model once, with the model fixed at the SDHM preferred parameter set, with the IMPLND roof area reduction factor set at effectively zero and

0.25, respectively. Least squares objective function values of 178.5 and 180.1 were obtained, respectively. It should be noted that for each of these two cases, the comparison of the observed and modeled synthetic data observations were identical since the parameter set was fixed at the SDHM preferred parameter set. Hence, the noted objective function values were solely due to stream discharge model to measurement misfit.

The third model calibration experiment involved a Levenberg-Marquardt (LM) supervised local search (see Skahill et al. 2009) for details regarding the Levenberg-Marquardt method of computer-based model calibration) wherein the initial estimate was at the SDHM preferred parameter set and the IMPLND roof area reduction factor initially set at 0.05. For this third model calibration experiment, 198 parameters were specified as adjustable (see Appendix 2 for the list of adjustable model parameters for this experiment, their names, initial values and specified lower and upper bounds). In order to better accommodate scaling issues resulting from the use of different units for different parameters, and in an attempt to decrease the degree of nonlinearity of the parameter estimation problem, the logs of these parameters were estimated instead of their native values; past experience has demonstrated that greater efficiency and stability of the parameter estimation process can often be achieved through this means (Skahill and Doherty 2006).

The third model calibration experiment, an actual inversion run (Levenberg-Marquardt based local search) terminated after 1596 model calls, and it resulted in reducing the objective function from a starting value of 178.4 to a final value of 143.9. Final objective function values are listed in Appendix 3 for the third model calibration experiment. Upon inspection of the parameter sensitivity file (see Doherty (2004) for a description of the various capabilities associated with the PEST tool) at the end of the third model calibration experiment inverse model run, it was apparent that specified adjustable model parameters associated with PERLNDs 1-4, 21-24, and 41-44 impaired the model identification process.

The fourth model calibration experiment also involved a Levenberg-Marquardt (LM) supervised local search wherein the initial estimate was at the SDHM preferred parameter set and the IMPLND roof area reduction factor initially set at 0.05. For this third model calibration experiment, 354 parameters were specified as adjustable (see Appendix 4 for the list of adjustable model parameters for this experiment, their names, initial values and specified lower and upper bounds). As with the third experiment, in order to better accommodate scaling issues resulting from the use of different units for different parameters, and in an attempt to decrease the degree of nonlinearity of the parameter estimation problem, the logs of these parameters were estimated instead of their native values. The fourth model calibration experiment, also an actual inversion run (Levenberg-Marquardt based local search) terminated after 3197 model calls, and it resulted in reducing the objective function from a starting value of 178.4 to a final value of 176.9. Final objective function values are listed in Appendix 5 for the fourth model calibration experiment. As with the third experiment, parameter insensitivity impaired the estimation process.

In light of the impaired LM-based inverse model runs, due to the observed parameter insensitivities, associated with the third and fourth model calibration experiments, a fifth model calibration experiment was performed using Truncated Single Valued Decomposition (TSVD) as a means to stabilize the inverse

model (see Skahill and Doherty 2006) for a brief discussion on TSVD). The adjustable model parameters, their initial values, and their lower and upper bounds were identical to those specified for the fourth model calibration experiment. The fifth experiment terminated after 17372 model calls, reducing the initial objective function value of 178.4 to a final value of 91.56. See Appendix 6 for the final objective function values associated with the fifth model calibration experiment.

While there was a notable objective function reduction with the TSVD run, relative to the two LM runs, plots of the hydrographs, most importantly, but also the costs associated with TSVD-based regularization (1. see Skahill and Doherty (2006) for a brief discussion on TSVD; 2. viz., biased and potentially unrealistic model due to potential overfitting) resulted in a final model selection to be the second model calibration experiment wherein there is an exact fit to the synthetic observations and comparable fits, with the other experiments, to the hard data (i.e., the observed flow data). Hence, the final model is simply the SDHM model with the one new parameter, red, specified the value of 0.25. Appendix 7 lists summary statistics associated with the final model calibration for the six periods identified for comparing stream flow observations with their model simulated counterparts. Figure 2.7 (a,b,c) provide the comparisons between simulated and measured flow rates for the six storms listed in Table 2..

**Table 2.10. Six storms for hydrological model calibration/validation.**

<b>Storm Number</b>	<b>Start Time/Date</b>	<b>End Time/Date</b>
1	11/30/2007 00:00:00	12/01/2007 23:00:00
2	12/07/2007 00:00:00	12/09/2007 12:00:00
3	01/05/2008 00:00:00	01/07/2008 23:00:00
4	01/27/2008 00:00:00	01/28/2008 23:00:00
5	02/03/2008 00:00:00	02/03/2008 23:00:00
6	02/24/2008 00:00:00	02/24/2008 23:00:00

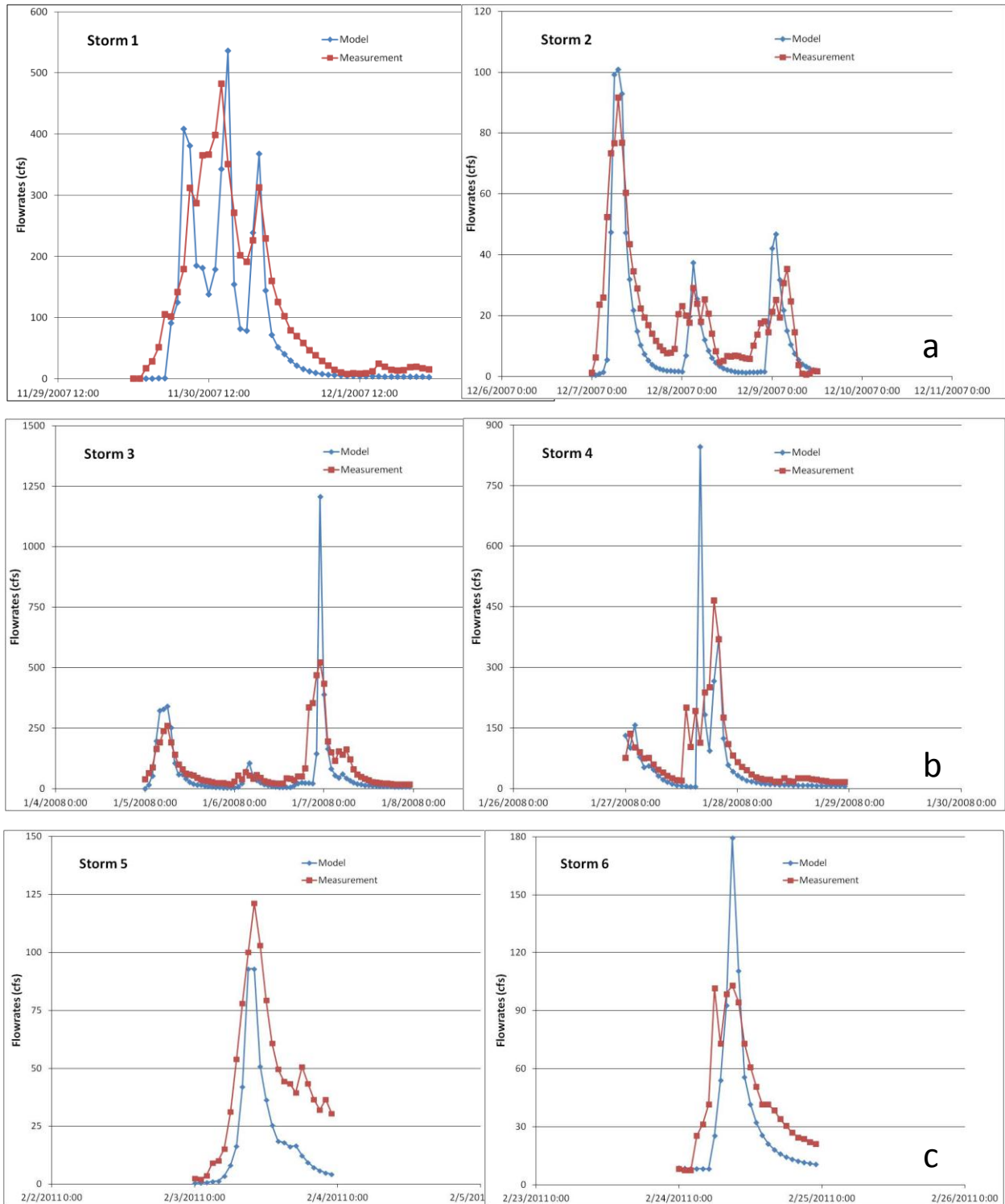


Figure 2.7. Plots of simulated (red) and measured (blue) hydrographs for Storms 1 and 2 (a), Storms 3 and 4 (b), and Storms 5 and 6 (c); see Table 2.10 calibration/validation dates.

## 2.3 Results and Discussion of Watershed Nutrient and Bacteria Loading Model Validation

### 2.3.1 Nutrients

Over the long term, the watershed model captured the observed nutrient and bacteria levels at the mass emission station. The observed ammonia levels were characterized by the model. The median model nitrite-nitrate concentrations were slightly greater than the measured but the observed concentrations were within the range of predicted values at the 10th percentile. The simulated total nitrogen showed greater range than the ammonia and nitrite-nitrate. The measured total nitrogen levels were in the lower range of the simulated but within the 25<sup>th</sup> percentile confidence intervals (Figure 2.8).

The model reproduced the observed range of dissolved and total phosphorous concentrations. The modeled median phosphate concentration were within 0.05 mg L<sup>-1</sup> of the average observed dissolved phosphorous concentrations and median total phosphorous predicted was within 0.01 mg L<sup>-1</sup> of the observed average. The range in observed variability was reproduced by the model at the 25<sup>th</sup> and 75<sup>th</sup> percentile intervals (Figure 2.9).

### 2.3.2 Bacteria

The greatest variability and difference between modeled and measured concentrations were in the bacterial predictions. Because of a paucity of bacterial land use runoff data within the modeled watershed, land use coefficients from a previous regional study (Tetra Tech) were used to characterize the land use export. Model coefficients were globally adjusted to approximate the observed bacteria levels in the watershed.

The model generally characterized the range of observed bacteria concentrations in the stormwater runoff. The model did not capture the lower fecal coliform and enterococcus levels measured during one storm. Another storm had total and fecal coliform concentrations greater than the 90th percentile confidence interval. Because the model over- and under-predicts bacteria levels, a systemic inaccuracy in the error was likely not present. The variability may more likely be reflective of episodic flushing from the system that would likely be difficult to be captured during land use stormwater monitoring. However, both the model and measured bacteria levels are more than an order of magnitude than the water quality standards and significant management actions will be required to mitigate those levels (Figure 2.10).

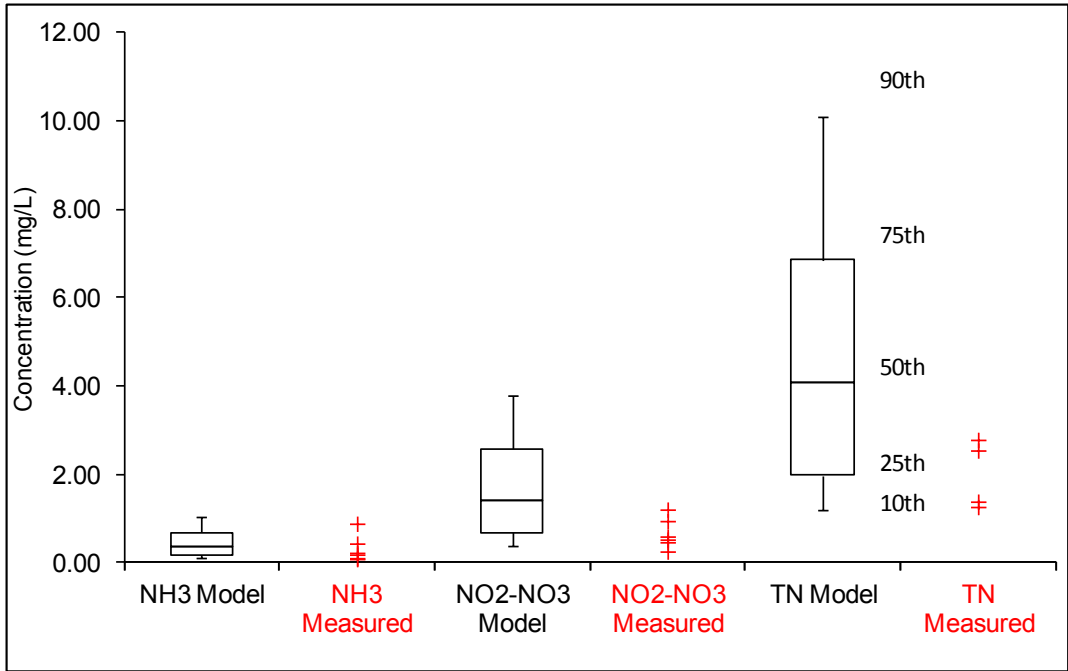


Figure 2.8. Comparison of measured and modeled stormwater bacteria from the Loma Alta Slough watershed (10<sup>th</sup>, 25<sup>th</sup>, 50<sup>th</sup>, 75<sup>th</sup>, and 90<sup>th</sup> simulated percentiles are shown).

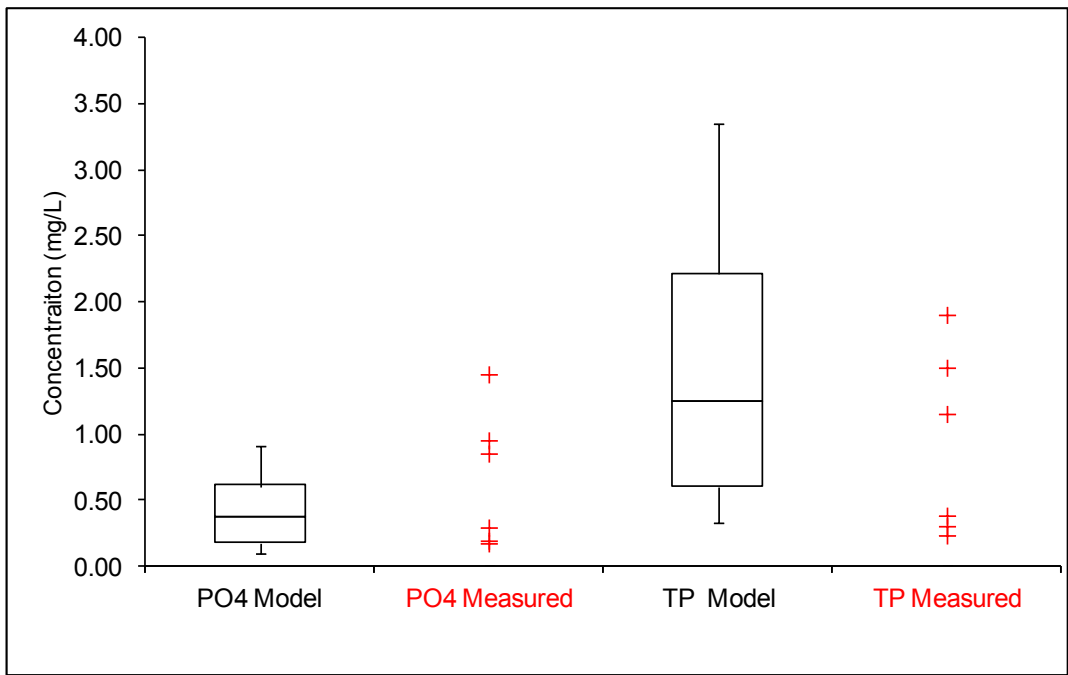
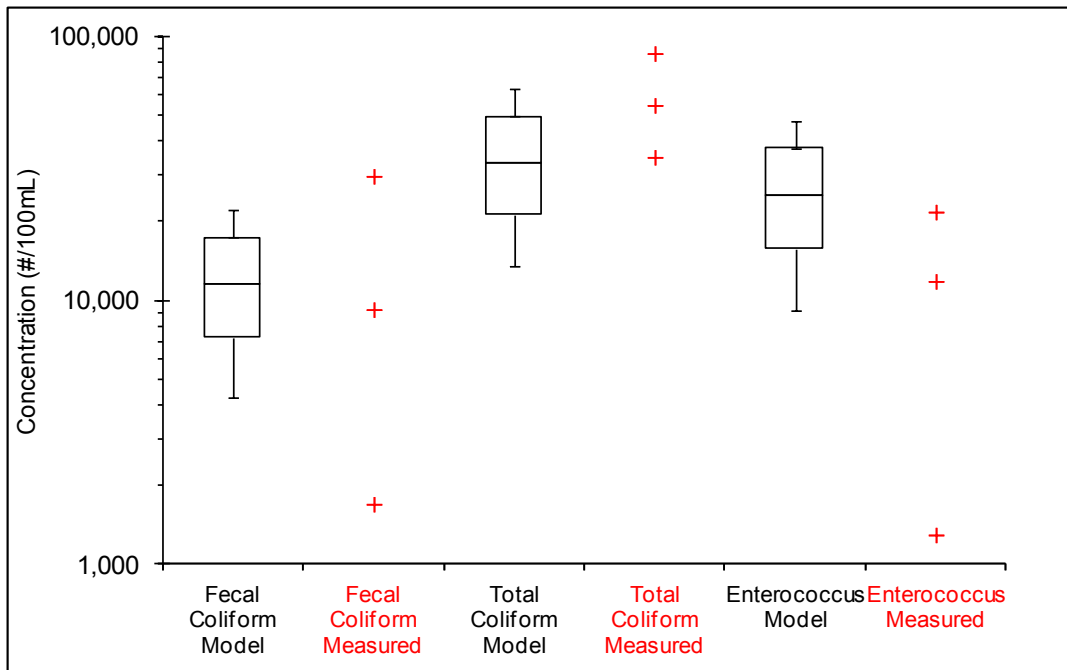


Figure 2.9. Comparison of measured and modeled stormwater nutrients from the Loma Alta Slough watershed.





**Figure 2.10. Comparison of measured and modeled stormwater bacteria from the Loma Alta Slough watershed.**

## 2.4 Uncertainties in Watershed Loading Model Results

Data compilation, analysis, and model calibration and validation were conducted to support development of a watershed loading model for the Loma Alta Slough watershed. The effort included identification and description of the watershed characteristics and types of spatial and time series data that were collected, processed, and utilized for the model. An approach was developed and applied for constructing, calibrating, and verifying the hydrologic model for the Loma Alta Slough watershed. The calibrated and verified hydrologic model was shown to be of predictive value, and capable of simulating hydrologic response based on land use and land cover, soils, and percent slope, and that capability is valid insofar as the SDHM model (which is well accepted by the hydrologic model practice community) is representative of the real world system.

While not performed, the existing Loma Alta Slough hydrologic model could rather easily be modified into the most identifiable hydrologic model representation possible, and then subsequently interfaced with stochastic global optimization capabilities encapsulated in the PEST tool (see Skahill and Doherty 200) and Skahill et al. 2009) to yield an upper bound in terms of the level of model to measurement misfit (solely focusing on stream discharge data for quantify misfit) that is possible with the given forcing and observation data.

For the Loma Alta Slough watershed model, simulation of the indicator bacteria enterococcus, fecal coliform, and total coliform was established by calibrating against the daily loading data listed in Appendix D-3 of the 2009 CHU Lagoon Monitoring Report prepared by Mactec. Fits obtained indicated

that all three bacteria loading models are predictive. In retrospect, log transformation of the loading data that was used for model calibration, and their model simulated counterparts, prior to objective function calculation, could be an avenue to pursue in attempts to ensure that the model is not biased towards over-fitting the higher loading values at the expense of the lower daily bacteria loading values.

## **2.5 Watershed Modeling Summary**

Data compilation, analysis, and model calibration and validation were conducted to support development of a watershed loading model for the Loma Alta Slough watershed. The effort included identification and description of the watershed characteristics and types of spatial and time series data that were collected, processed, and utilized for the model. An approach was developed and applied for constructing, calibrating, and verifying the hydrologic model for the Loma Alta Slough watershed. The calibrated and verified hydrologic model was shown to be of predictive value, and capable of simulating hydrologic response based on land use and land cover, soils, and percent slope, and that capability is valid insofar as the SDHM model (which is well accepted by the hydrologic model practice community) is representative of the real world system.

While not performed, the existing Loma Alta Slough hydrologic model could rather easily be modified into the most identifiable hydrologic model representation possible, and then subsequently interfaced with stochastic global optimization capabilities encapsulated in the PEST tool (see Skahill and Doherty 2006 and Skahill et al. 2009)) to yield an upper bound in terms of the level of model to measurement misfit (solely focusing on stream discharge data for quantify misfit) that is possible with the given forcing and observation data.

For the Loma Alta Slough watershed model, simulation of the indicator bacteria enterococcus, fecal coliform, and total coliform was established by calibrating against the daily loading data listed in Appendix D-3 of the 2009 CHU Lagoon Monitoring Report prepared by Mactec. Fits obtained indicated that all three bacteria loading models are predictive. In retrospect, log transformation of the loading data that was used for model calibration, and their model simulated counterparts, prior to objective function calculation, could be an avenue to pursue in attempts to ensure that the model is not biased towards over-fitting the higher loading values at the expense of the lower daily bacteria loading values.

### 3 ESTUARY HYDRODYNAMIC MODEL CALIBRATION AND VALIDATION

This section summarizes the development, calibration, and validation of the estuary hydrodynamic model for Loma Alta Slough. This includes identification and description of the data that were utilized for the model, as well as the approach that was followed for constructing, calibrating, and verifying the model for Loma Alta Slough.

#### 3.1 METHODS

##### 3.1.1 Previous Work

In 2008, Tetra Tech completed a report on initial data compilation and model configuration for the 7 listed lagoons in San Diego County (Tetra Tech 2008). Previous work consisted of setup of the LSPC (Loading Simulation Program in C++) model and EFDC (Environmental Fluid Dynamics Code) model for simulating the watershed runoff and the slough flow hydrodynamics, respectively. Some of the LSPC model input files were given to CMA by Tetra Tech, and used as a starting point for the modeling. The LSPC model uses streamlined algorithms of HSPF, and since we had to re-create some of the incomplete input files, we set up the complete HSPF model for the watershed loading simulations. The EFDC model was not received, and no details about the model setup or input data or model parameters were available in the report. A coarse model grid for the EFDC model was shown, which was proven to be inadequate to resolve the strong depth gradient in the slough.

##### 3.1.2 Model Selection

The hydrodynamic model Environmental Fluid Dynamics Code (EFDC) was selected to model the hydrodynamics and bacteria in Loma Alta Slough. Its governing hydrodynamic equations are three-dimensional (i.e. it addresses water movement up and down stream, vertically in the water column, and horizontally across the channel). The model balances water pressure while allowing water density and water surface elevation (WSE) to change with turbulence-averaged equations. It is a three-dimensional sigma-coordinate model, meaning that there are a constant number of layers throughout the model domain each with a specified percentage of total depth and thus, the thickness of those layers changes with WSE (Tetra Tech 2002). EFDC has been used extensively throughout the United States with applications including the Los Angeles Harbor/San Pedro Bay and Dominguez Channel.

There exist many versions of the EFDC models, and not all of these versions are suitable for this study. We acquired an updated version of EFDC source code from EPA Region IV, Atlanta, GA in July 2010, which has been configured for the current study. We set up the model by generation of a model grid, specifications of model boundary conditions, model test and diagnostic runs, problem identification, debugging, and solving, and finally model simulations for the study.

WASP Version 7.4 (Water Quality Analysis Simulation Program V7.4) was used to simulate the transport and fate of nutrients in Loma Alta Slough. EFDC output is stored in a link file (LomaAlta.hyd) that links to WASP7.4, which simulates the water quality and eutrophication condition of the Slough. The EFDC model also is required to be linked with WASP, for which, hydrodynamic output from EFDC is generated as a stand-alone binary file for the entire simulation period (LomaAlta.hyd). The configured water

quality model (e.g., WASP7.4) then links with the hydrodynamic file to drive the transport and eutrophication runs for the slough.

### *3.1.3 Data Sources*

Data were collected to characterize the model domain, inputs and the conditions within the estuary. Data sources used for the study are summarized below.

#### *Physical Setting*

Merged bathymetry and topography was derived from LiDAR data, which covered from approximately 150 m off the ocean beach to the railroad bridge. Based on the LiDAR data, bottom elevations and slope of the Slough were generated and extended from the railroad upstream passing the Coastal Highway Bridge (Figure 3.1).

#### *Atmospheric Conditions*

Meteorology data was used in the simulation of WSE (barometric pressure) and temperature (atmospheric temperature). EFDC requires the following meteorological data:

- air temperature
- relative humidity
- solar radiation
- dew point
- wind speed
- evaporation rate
- cloud coverage

Meteorological daily data measured at Torrey Pines was used for EFDC. In addition, temperature boundary conditions need to be prescribed at the upstream riverine segment and downstream oceanic segments. The measured temperature time series at ME was used as the riverine boundary condition, and temperature at the ocean was assumed to vary linearly from 15 to 16°C from Jan-May.

#### *Oceanic Conditions*

The oceanic WSE was needed to drive the simulation of tidal circulation within the Slough Tide gauge data for tidal conditions at or near the Slough is lacking. NOAA's tide records at La Jolla (<http://NOAA-tide.gov>) are the closest tide data and were used for setting up the ocean boundaries for the study. The scattered surf and tide data (high and low tides) at Oceanside were compared with NOAA's tide gauge data and revealed that, while there is a phase lag of about 15 minutes between La Jolla and Oceanside, the magnitudes of high and low tides are very close at these two locations. Therefore, NOAA's tidal records at La Jolla for 10/1/2007 through 10/31/2008 were used for this study.

Like the oceanic WSE boundary, no temperature or salinity data was available for the nearshore area adjacent to the mouth of LAS. Temperature and salinity data are necessary to define conditions at the boundary of the region being modeled. Therefore, data from the Scripps Pier in La Jolla, which is the closest monitoring station to the LAS were used ([www.sccoos.org](http://www.sccoos.org)).

### Inputs

Loma Alta Creek is the major source of freshwater discharging to LAS. Groundwater inputs are unquantified. Flow data were obtained to calibrate and validate the wet weather watershed loading model (Section 2) and to quantify the daily dry weather average flow into the LAS. Flow data, temperature, conductivity, bacteria (enterococcus, fecal coliform, total coliform), and total and dissolved inorganic nitrogen and phosphorus, and biological oxygen demand were obtained from Mactec (2009), data collected in support of the SDRWQCB Monitoring Order # R9-2006-0076 for Loma Alta Slough and other 303(d) listed estuaries. Discharge data measured at the ME station were used to drive the EFDC hydrodynamic simulations for both the wet period (1/1/2008-4/1/2008) and dry period (5/1/28-10/21/2008). Salinity and temperature measured at the ME station were used as the riverine boundary conditions.

### Slough Hydrodynamic Data and Continuous Water Quality Data

Data from in situ instruments deployed by Mactec (2009) at two stations including Segment 1 and the Ocean Inlet Stations were used to simulate WSE, salinity, temperature, and dissolved oxygen within the Slough.

### Additional Observations

Site visits to the Slough were conducted three times in April, October 9 and October 15, 2010 to observe how the Slough water exchanges with the ocean. During the April trip, it was observed the incoming tides flushed through a narrow channel of the Ocean Inlet into the slough. It was also observed the apparent movement of ocean water into the slough during the two-hour period. On October 9, two days after a major storm, a new channel was formed in the north side of the Ocean Inlet that drained the slough water into the ocean. On the third trip of October 15, the site was observed during both high and low tides. During the high tide (11:23 AM), the slough was almost separated from the ocean by the high sand berm near the Ocean Inlet. Only the highest tides could find its way through the very shallow “channel” on the south side of the inlet over the sand berm into the slough. During the low tide in the afternoon (~5:00 PM), the sand berm remained intact. The slough water was separated from the ocean, and could not be flushed out with the low tide. Observations from the three field trips show three different scenes regarding the dynamic nature of the water exchange near the Ocean Inlet.

### 3.1.4 Model Set Up and Development

#### Grid Generation

Initially, a model grid, similar to that shown in the Phase I (Tetra Tech 2008), was generated. There were about 20 segments along the main stretch of the creek, with an average of 30 m long for each segment. During the diagnostic runs, this model grid shows inadequate resolutions along the river stretch and therefore, a second and current grid was generated. This grid increases the creek-stretch resolutions, in particular, near the Ocean Inlet where bathymetry varies greatly from the deepest Ocean Inlet to the shallowest sand berm near the bridge. As a result, the total number of segments along the creek increases from 24 to 28 (Figure 3.1).

The LiDAR data and measured bathymetry at two locations, including Ocean Inlet and Segment 1, in the slough were used to define the bathymetry of the study area. The LiDAR data covers regions about 150 m from the coastlines to the railroad bridge. The bottom elevations upstream of the railroad bridge to the river boundary segment (Segment Station # 8) were generated by extrapolating the bottom slope from the LiDAR data between the Ocean Inlet and the railroad bridge (Segment Stations #11-18; Figure 3.1).

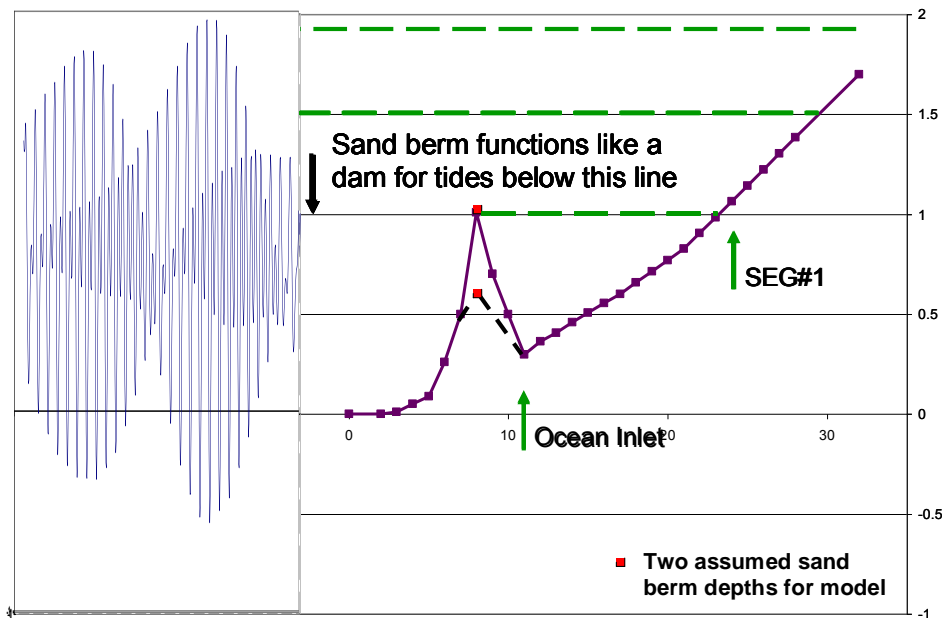


**Figure 3.1. The EFDC model grid for Loma Alta Slough.**

*Boundary Conditions*

There are two boundaries for the model grid, the upstream boundary and downstream ocean boundary (Figure 3.2). The upstream boundary (Segment #28) receives freshwater inflows and contaminant loads from the watershed. For this study, freshwater discharges measured at the ME station during 1/1/2008-10/31/2008 is used for input at the river boundary. The downstream boundary connects and receives forcing from the ocean tide. The NOAA’s ocean tide data measured at La Jolla is used to at this boundary. It is noted that the NOAA’s tide data are based on MLLW and NAVD, which are only different by  $\sim 5 \text{ cm sec}^{-1}$ . We used the tide data with reference to NAVD at the ocean boundary.

Salinity and temperature data measured at the ME site, 1/1/2008-10/31/2008 are used to act as the boundary condition for the transport simulation of these two water quality parameters. The downstream boundary conditions at the ocean are set to be fixed constants of 36 ppt for salinity and 15°C degree for temperature throughout the simulation periods. Meteorological data measured at Santa Barbara is used as the boundary conditions over the surface of the creek for heat balance (temperature) calculation in the model.



**Figure 3.2. Schematic model cross sections, depths, sand berm, riverine and ocean boundaries.**

### Model Linkage

EFDC simulates hydrodynamic current and water surface elevation, which are then linked to EPA’s water quality model, WASP7.4, to drive the eutrophication and water quality modeling. We acquired and configured EPA’s newest version of eutrophication model, WASP 7.4 for Loma Alta Slough. The water quality configuration includes two parts, model parameterization and assignment of constants and forcing terms, and assignment of hydrodynamic transport. WASP7.4 has two options of using hydrodynamic transport. WASP can assign the flows and water model segment volumes internally in the model input file. WASP7.4 can also use an externally-generated hydrodynamic file, such as the LomaAlta.hyd generated by EFDC, to drive the model runs. Based on the requirement for this study, the EFDC-generated hydrodynamic file, LomaAlta.hyd is linked with WASP7.3 for eutrophication modeling study.

### Implications of Railroad Trestle Construction Activities

Construction by Amtrak to replace and double-track the railroad crossing over the slough took place between August 2007 and August 2008. During construction a berm of imported sediment and gravel with four large corrugated metal pipes to allow flow was created under the trestles spanning from the

north to the south bank. Construction activities were documented ([www.arena.org/files/library/2009\\_Conference\\_Proceedings/The\\_Oceanside\\_Passing\\_Track\\_and\\_Bridge\\_Replacement\\_Project.pdf](http://www.arena.org/files/library/2009_Conference_Proceedings/The_Oceanside_Passing_Track_and_Bridge_Replacement_Project.pdf)). It was observed that the sand berm seemed to hinder and slow down the water from flowing downstream across the berm during high creek discharges and/or low tidal stages. During high tides, slough water reversed its direction, flowing upstream the creek. Since these conditions were unique to the construction timeframe, the simulation and characteristics of flows without the sand berm/culvert were based on two assumptions. The first assumption was that the 2008 construction was only a one-time event, not a normal condition for the slough. The second assumption was that even with the construction, the culvert and the sand berm hindered and slowed down the flow downstream, but they did not stop the flow. Therefore, modeling results with the culvert should be applicable to interpret measured water surface elevations and salinities during the period.

#### Model Calibration and Validation

Model calibration and validation compared model output to measurements made in the Slough. The first comparison was between measured and modeled water surface elevation at the Ocean Inlet (OI) and Segment 1 (Segment 1; Figure 1.2). Next, the measured and simulated temperature and salinity in the lower portion of the waters at the same sites were compared.

The model was calibrated and validated for bacteria and nutrients by comparing model output against the data collected at the *in situ* sampling locations throughout 2008. Model output was compared against measured constituents for bacteria, nutrients, and algal biomass.

#### Sensitivity Analysis

Model performance is influenced by confidence in the input data used for model development and calibration. Sensitivity analysis is an important step of the model development process; it quantifies the effects of specific data sets, including their uncertainty level, on model results. The results of the sensitivity analysis can also be used to identify priorities for future data collection.

Sensitivity of the LAS model was evaluated by altering key model parameters and assessing the relative effect on model predictions.

#### Resolution of Issues Identified with Dry Weather Flow Data

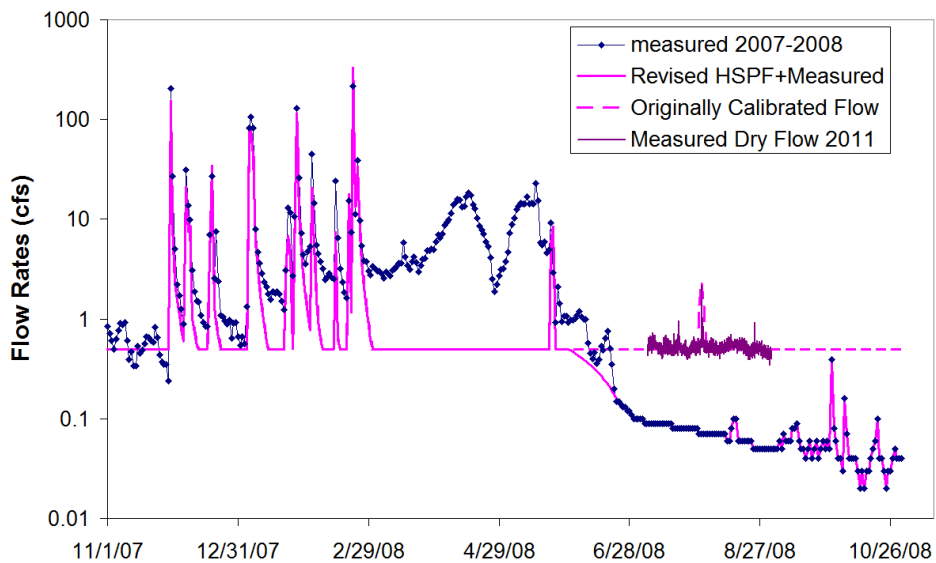
Although wet weather events constituted most of the loading of flows and bacteria to the slough water, dry weather flows are equally (if not more) important in governing transport and dilution in the slough water. This is because during wet weather, the inlet was open and large watershed runoffs flushed the slough from the upstream to the ocean fairly fast, with traveling time estimated to be less than one day for each storm. In contrast, dry weather condition constituted a large portion of the entire study periods including the periods when the inlet was open and when the inlet was closed. As such, dry weather base flows are significant and pivotal in determining the dilution and transport patterns in the slough during the dry weather condition.

During the study period, we identified potential errors in both the magnitude and behavior of the original measured dry weather base flow (Mactec 2009). The magnitude of the measured base flow was

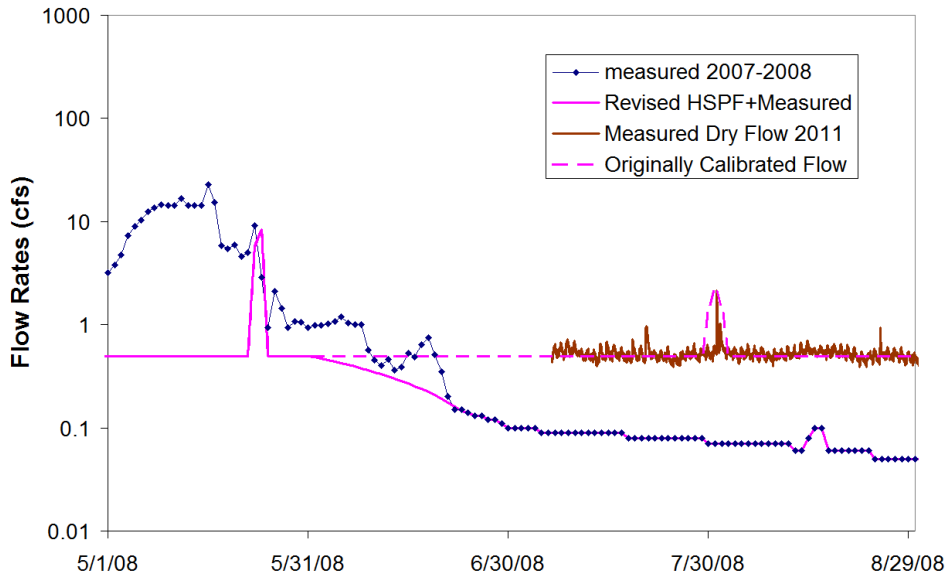


suspected to be over predicted (measured) by an order of magnitude before the inlet was closed (May, 2008) and under predicted (measured) by an order of magnitude during the period when the inlet was closed. Meanwhile, during the dry weather period, there was moderate precipitation on May 24, 2008, and no signal of such precipitation event was reflected in the measured flow. Measured flow shows significant pulses during the end of October 2008 when there was not any precipitation during the period. These over and under measured flow rates before and after the inlet was closed, in conjunction with the inconsistencies between the measured flows and precipitation have put validity of the measured dry weather base flow in question.

Through model calibration, we estimated that dry weather base flow would need to be 0.495 cfs in order to achieve best matches of salinity and temperature between model prediction and measurement. This 0.495 cfs would need to persist throughout the dry weather period (spring and summer). In Figure 3.3 and Figure 3.4, the originally calibrated flow (dashed line) includes both wet weather flow (most in Jan-Feb, 2008) and dry weather base flow. Prior to Jun 1, the revised flow predicted by the watershed model coincides with the originally calibrated flow. For Jun 1-October 31, 2008, we used measured flow which is one order of magnitude less than that of the originally calibrated flow.



**Figure 3.3. Dry weather base flows (newly measured dry based flow for July 7-Aug 31, 2011 are plotted with the same months/dates for 2008).**



**Figure 3.4. Close-up look of dry weather base flows (newly measured dry based flow for July 7-Aug 31, 2011 are plotted with the same months/dates for 2008).**

All of these issues discussed above were reported and discussed during the stakeholders' meetings and decisions were made to re-sample dry weather base flow during the summer of 2011. On Sep 17, 2011, we received measured dry weather base flow for Jul 6-Aug 31, 2011, which is plotted with the 2008 flows for the same months/dates with the year assumed to be 2008. During the period of Jul 6-Aug 31, 2011, dry weather base flow maintained relatively constant values with a mean of  $\sim 0.55$  cfs, which is coupled with some fluctuations with amplitudes of about 0.05 cfs. These patterns of the newly measured dry weather base flow are much more consistent with those in the originally calibrated flow. The difference of the calibrated and newly measured mean flow is about 10% and both flows tend to persist throughout the entire dry weather period.

It is believed that the newly measured dry weather base flow behaves much more in line with the model calibrated flow. These new flow data were used in all simulations for water quality.

## 3.2 Results and Discussion of the Estuary Hydrodynamic Model

### 3.2.1 Wet Season (January-May 2008)

During the period of 1/1/2008-10/31/2008, water surface elevations, salinity and temperature were measured at two locations: Ocean Inlet (OI) and Segment 1 within the creek. EFDC model simulations over the two seasons, the wet season from 1/1-5/31/2008, and the dry season, 6/1-10/31/2008, were conducted and results are compared with the measurements. During the wet season, 1/1-5/31/2008, the OI is assumed to remain open with the sand berm at the OI assumed to be at two heights, 100 and 60 cm with the NAVD reference. As discussed previously, formation and evolution of the sand berms is highly dynamic with different time scales involved, which is outside the scope of the current study. As

such, we assume two heights for the sand berm for the EFDC model to simulate the hydrodynamics and flow conditions.

Water Surface Elevation

EFDC was set up and simulations over the period of 152 days (1/1-5/31, 2008) were conducted. Model results are presented and analyzed by each month from Jan-April for the sake of clarity, since much data and information is involved. Table 3.1 and Figure 3. show the statistics of simulated and measured water surface elevation (WSE) at OI and Segment 1 stations Jan-Apr 2008 (Figure 3.5). Monthly means and Root Mean Square (RMS) are shown in Table 3.1.

**Table 3.1. Summary statistics for water surface elevations (means and root mean square error) between model and measurement 2008.**

	WSE at OI (meter)			WSE at Segment 1 (meter)		
	Model	Measured	RMS	Model	Measured	RMS
<b>Jan-08</b>	0.95	0.94	0.34	1.02	0.98	0.26
<b>Feb-08</b>	0.97	0.9	0.34	1.04	0.95	0.27
<b>Mar-08</b>	0.95	1.03	0.41	1.02	1.09	0.29
<b>Apr-08</b>	0.98	1.02	0.29	1.03	1.08	0.23

Error! Reference source not found.

**Figure 3.5. Simulated water surface elevations during different tidal and river discharge conditions (vertical dimensions are up to the scale, horizontal dimension of the river stretch are off the scale distance from Segment Station #7 to Segment Station #28 is about 400 m).**

Figure 3.6 shows simulated water surface elevations over the model axis of the slough during various tidal stages. In general, regions near the upstream boundary tend to function as a river with ocean tides come and go and downstream regions are more influenced by the ocean tides. These similar but different flow and transport patterns are reflected in the salinity variations, which will be discussed later. In general, model simulated water surface elevations are smooth and reasonable throughout the simulation periods.

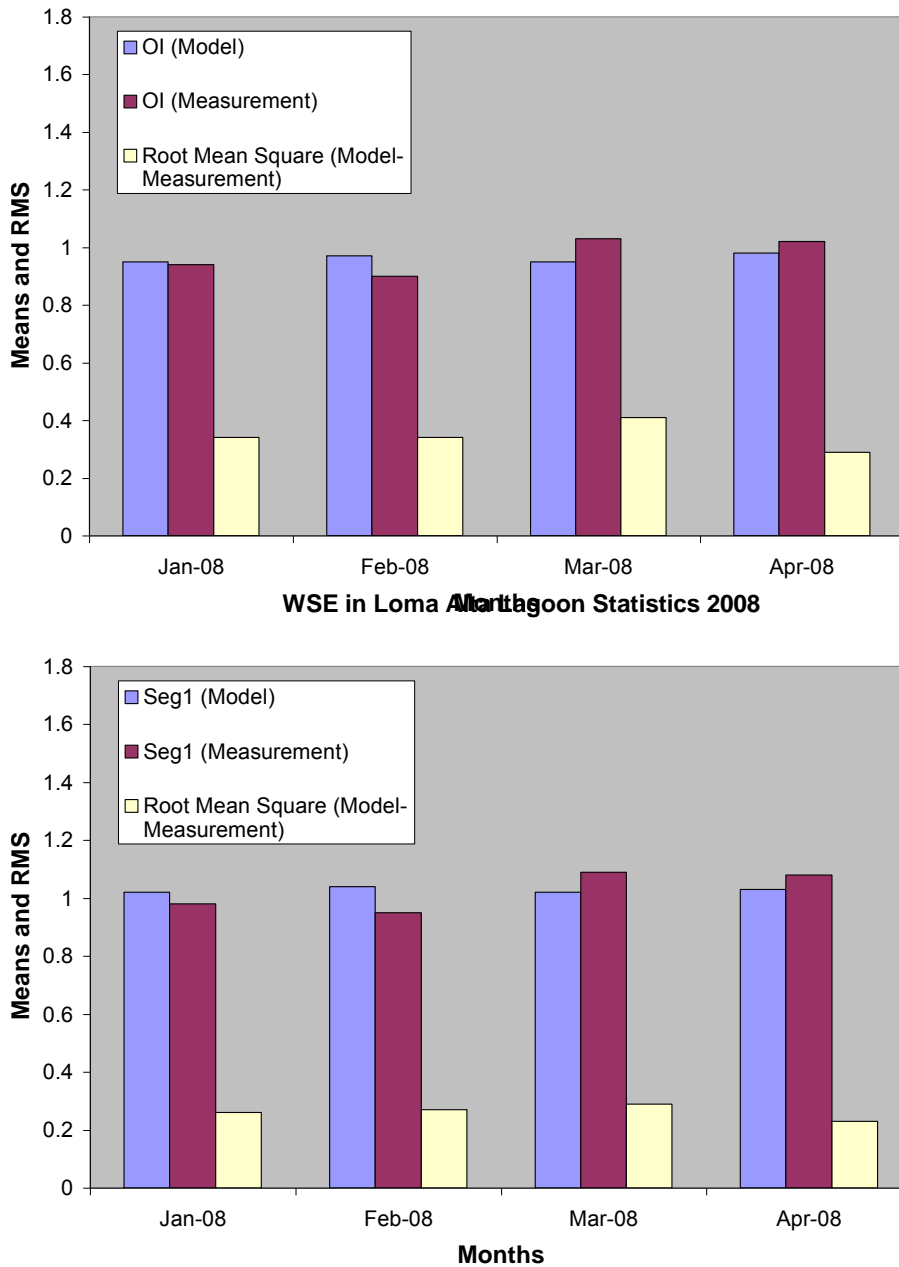
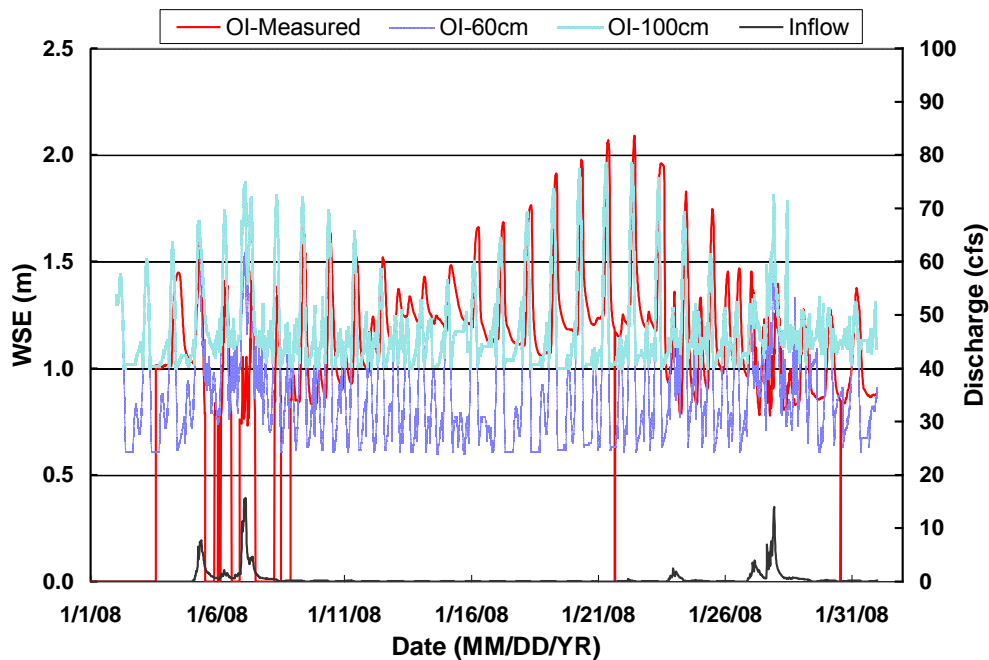


Figure 3.6. Means and RMS of WSE at OI (above) and Segment 1 (bottom).

Figure 3.5 shows the measured and simulated water surface elevations at OI for January 2008. Two modeled water surface elevations were generated for the two sand berm heights of 100 cm and 60 cm, respectively. In general, simulated WSE at OI fluctuates with the ocean tides, attaining heights during flooding tides and receding during ebbing tide, which is regulated by the sand berms. The small time lag (~40 minutes) between the model and measurements, coupled with the time lag of ~15 minutes of the ocean tide between La Jolla and Oceanside, suggests that there is a time lag of about one hour between the model and measurement. It is not clear at this stage what might have caused this one-hour time discrepancy. During flooding tides, in particular, the spring tides, ocean water flushes into the creek through the sand berm, therefore, peak water surface elevations at OI are in line with the ocean tidal stages, as predicted by the model. As the tides are subsiding and ebbing, the creek water starts to flow out until the ocean tidal height is below the sand berm and the creek water is blocked by the sand berm from flowing out. Thereafter, the water surface elevations remain at the height regulated by the sand berm.

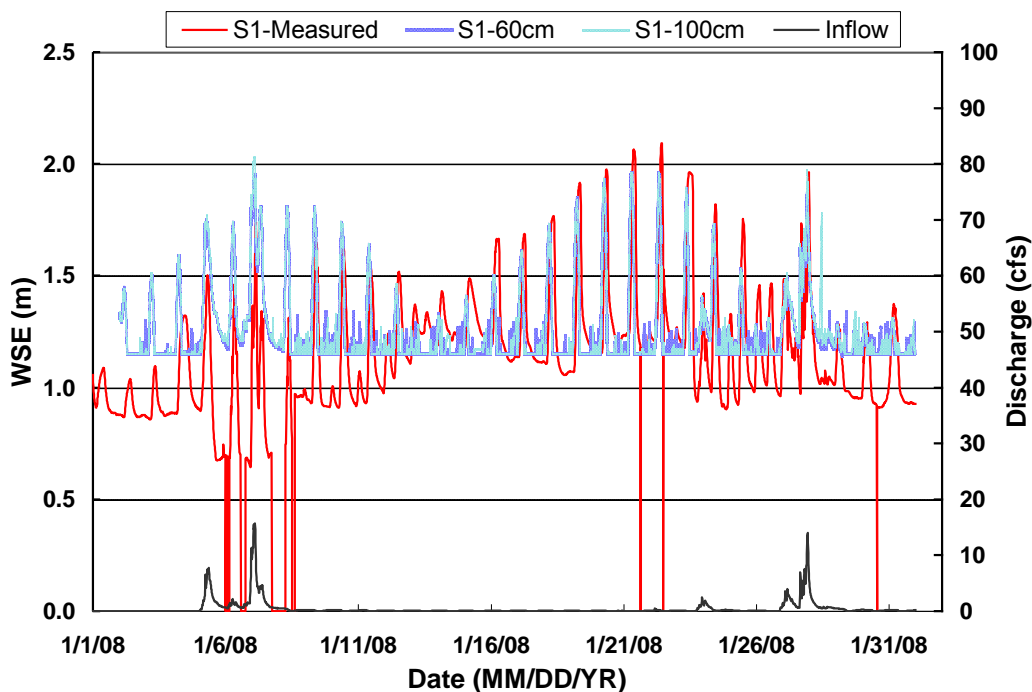


**Figure 3.5. Comparisons of measured (red) and modeled (blue for 60 cm and green for 100 cm berm heights) water surface elevations at OI, with runoff discharge in black for January, 2008.**

Water surface elevations at SEG#1 show interesting phenomena (Figure 3.6). During the simulation period, construction took place below the railroad bridge. A “dam” wall with a culvert was built and the flow across was hindered or regulated. An effect of the culvert is to regulate and reduce flows across the two sides of the culvert. For example, the flooding tides will increase the water surface on two sides of the culvert. During ebbing tides, water upstream of culvert will be regulated to recede at a slow rate due to the culvert.

The 2008 construction was a rare event, not a normal situation. For normal situations, model simulated water surface elevations at SEG#1 are analyzed and compared with measurements, knowing that conditions for model simulations and measurements were not the same.

For SEG#1, water surface elevations were flooded during high tide, similar to those at OI. During ebbing tide, the water surface elevation can be reduced only to the height of the sand berm or the bottom at SEG#1, the larger of the two. For our scenario, it is the bottom of SEG#1. According to the LiDAR data, depths east of OI are sloping up with water depths decreasing toward SEG#1 and further upstream. Therefore, initial depth at SEG#1 (~0.6 m) is less than that at OI (~1.4 m). When the ocean tide is below the sand berm (~1 m and 0.6 m, NAVD), SEG#1 gets exposed and becomes dry. The model assigns a minimum depth (~15cm) as the cell becomes dry, which may get re-wetted when ambient flows advected through. Therefore, the water surface elevation at SEG#1 is dictated by the flooding during high tide and getting the bottom dry during low tide. Communication with Mr. Honma reveals that depth at SEG#1 may not be shallower than depth at OI. If this is true, we will have to question how representative the LiDAR data, which is a snapshot survey in the past, is and what kind of bathymetry data we should use in order to fully describe reality.



**Figure 3.6. Comparisons of measured (red) and modeled (blue for 60 cm and green for 100 cm berm heights) water surface elevations at SEG#1, with runoff discharge in black for January, 2008.**

In general, measured and model predicted WSE are both oscillatory both in line with the tides. In particular, the WSE peaks between model and measurement are in the same oscillatory trends dictated by both diurnal and spring/neap tidal cycles. Such close matching between model and measurement of the peaks of WSE exists for both OI and Segment 1 throughout the wet season (1/1-4/1/2008), except

for March 21-30, 2008. During this 1-week period, the model under-predicts the WSE by about 25 cm at both OI and Segment 1. The model predicted WSE are in line with the ocean tides at the end of the spring tide and beginning of the neap tide, whereas the measured WSE still maintained the same levels during the three week period of 3/11-3/31/2008.

While the peaks of WSE between the model and measurement are in line with each other throughout the period, the low WSE (trough) are governed by the height of the sand berm near OI and the water depth at Segment 1. For the modeling study, two sand berm heights are assumed (100 cm and 60 cm). Troughs of measured WSE seem to fluctuate between these two values. The dynamics and temporal variations of the low WSE reflect those of sand berm height and local water depth. In particular, effect from the dynamics of sand berm height is more pronounced at OI than that at Segment 1. WSE at Segment 1 is governed by the wet (flood tide) and dry (ebb tide) of the local depth.

### Salinity

Salinity is a conservative material often used to calibrate a hydrodynamic model and to check validity of hydrodynamics and transport of the model. In general, salinity is expressed as a unit in ppt (parts per thousands). In practice, sometimes salinity is measured in the unit of conductivity ( $\text{mS cm}^{-1}$ , or  $\mu\text{S cm}^{-1}$ ), which is a function of salt concentration (e.g., ppt) and temperature, and therefore, becomes a non-conservative in its measurement. Therefore, to simulate and compare salinity results, conductivities measured at the three stations, including OI and Segment 1 and the ME stations, are first converted into salinities in ppt unit. EFDC model is set up with an initial salinity of 15 ppt assigned to all model grid cells with the river boundary condition assigned from the measured salinity. The downstream ocean-side boundary is assigned with 36 ppt.

Figure 3.7 shows the comparisons of salinities at OI and Segment 1 for Jan/2008 between the measurements and model simulation results using the measured discharge data and model simulated runoff, respectively. For each comparison, a set of three time series were used, including measured salinity, simulated salinity at the surface and bottom layer. In addition, the watershed runoff discharge time series is also plotted using the secondary (right) y-axis.

In general salinity at OI fluctuates with tidal variations. Salinities in the OI regions increase during high tides when ocean water floods into the creek. Salinities decrease when the tides subside. The creek water is subject to the actions and interactions from both boundaries, including freshwater inflows upstream and saline ocean water downstream. The amplitudes of tidal oscillation in salinity are obvious, which are smaller than those of the water surface elevations.

Differences of simulated salinities between the surface and bottom layers are on the order of 0 to 15 ppt, which also fluctuate with tides and river discharges. In general, the fluctuation amplitudes of simulated salinity using the measured discharge data are on the order of 15 to 20 ppt, which is greater than those of  $\sim 10$  ppt by the measurements. In other words, river discharges seem to have greater effects on salinities at OI predicted by the model than the measurements. Amplitudes of EFDC-predicted salinity using the model-simulated discharge data are on the same level as those of the measurement ( $\sim 10$  ppt). In general, riverine effects on salinity at OI seem to exist on a daily basis, which can only be

offset by the tidal flooding during high tides. In general, EFDC-predicted salinities using the measured discharge data are in agreement with measured salinity only qualitatively, whereas, EFDC-predicted salinities using the watershed model-predicted discharge data are in excellent agreement with the measured salinities throughout the wet season.

The creek water is characterized by the sudden drop of salinity during the storms. This can be seen in Figure 3.7, where drop in salinity occurs for nearly all the storms, during which the creek water is totally flushed by the freshwater from the watershed runoff. The runoff flush extends from the upstream all the way to downstream regions, including the OI station. As such flows and salinity variations show characteristics of river flows during the period, ocean tides are not strong enough to offset the freshwater flushing.

Figure 3.7 also shows model-measurement comparison of salinity for the ocean inlet and SEG1 for the months of March and April, 2008, respectively. In general, model results suggest that salinities at SEG1 are governed by two processes, high ocean salinity during the high tides, and low river salinity during the low tides. At low tides, bottom elevation at SEG1 is slightly below the sand berm height which is assumed to be at 100 cm and 60 cm, respectively. Therefore, SEG1 is characterized by the sloped river flow when the water surface elevation is reduced to the same height as the sand berm, and salinity is dictated by the river (upstream) flow. Such salinity variations and characterization at SEG1 exist for all the wet season periods.

Significance of the low base flows in March and April of 2008 is reflected in the salinity data. Under prediction of salinity using the measured discharge data is greatly and significantly improved by using the modified dry weather inflows. The model-measurement comparison and analysis results seem to suggest that the use of modified discharge data is preferred over the use of measured discharges for EFDC, since the simulated discharge data produces better simulated salinities at OI and SEG1 throughout the wet season (Jan -Apr, 2008).

### Temperature

Figure 3.8 shows model-measured comparisons of temperature at OI and Segment 1 for the months of Jan, Feb, Mar and Apr, 2008, respectively. In general, the amplitudes of oscillation of the simulated temperature are smaller than those of the measured temperature. This is because we used daily meteorological data for the model, whereas oscillations in measured temperature are driven by the diurnal cycle of meteorological data. Such diurnal oscillations are not adequately simulated in the model due to the use of daily meteorological data. From the figures, it shows that simulated temperature at OI and Segment 1 follows the measured temperature both in trend and magnitude. Measured temperature is within the range enveloped by the simulated temperatures in the surface and bottom layers. During Jan-Feb, simulated temperature in both the surface and bottom layers is about of the same magnitude. Starting from Mar to Apr when solar radiation and air temperature started to arise, simulated temperature in the surface layer started to be elevated, deviating away from the bottom temperature. However, large differences of temperature up to 5<sup>o</sup> C were observed between model and measurement with periods of 3-7 days during Mar 11, Apr 16 and Apr 30. This is probably due to the fact that temperature was measured at a deeper section of the Slough where water was



retained during low tide and the small amount of water is subject to the solar heat at fast rates. This phenomenon and interpretation between model and measurement is similar to those for salinity at SEG1, as was discussed previously. With temperature, the phenomenon is more pronounced due to the non-conservative nature associated with temperature.

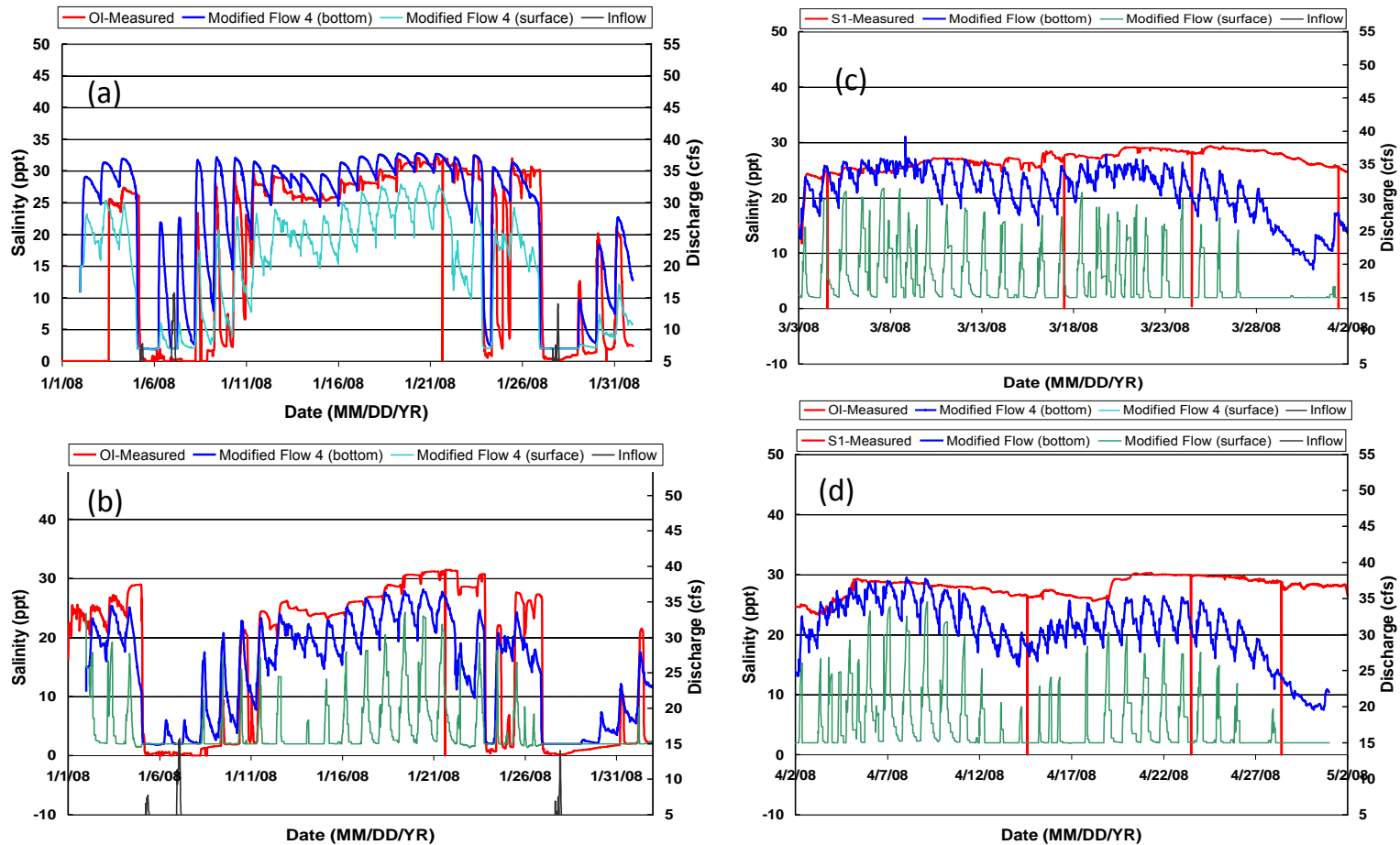


Figure 3.7. Comparison of measured (red) and modeled (blue for bottom and green for surface layer) (a) salinities at OI, using adjusted runoff discharge (in black) for Jan, 2008, (b) salinities at Segment 1, using simulated runoff discharge (in black) for Jan, 2008, (c) salinities at SEG1, using modified discharge (in black) for Mar, 2008, and (d) salinities at SEG1, using modified discharge (in black) for Apr, 2008.

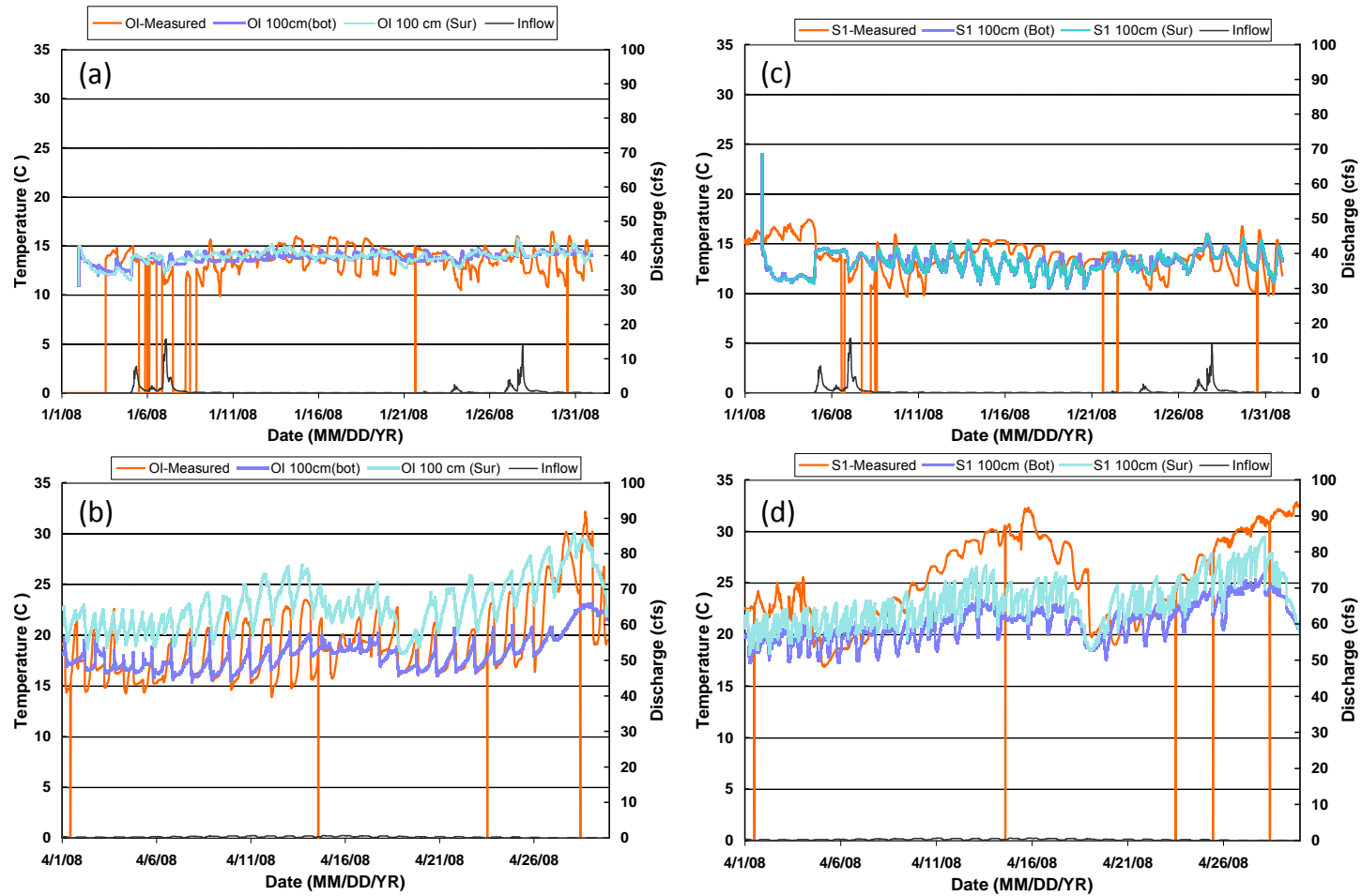
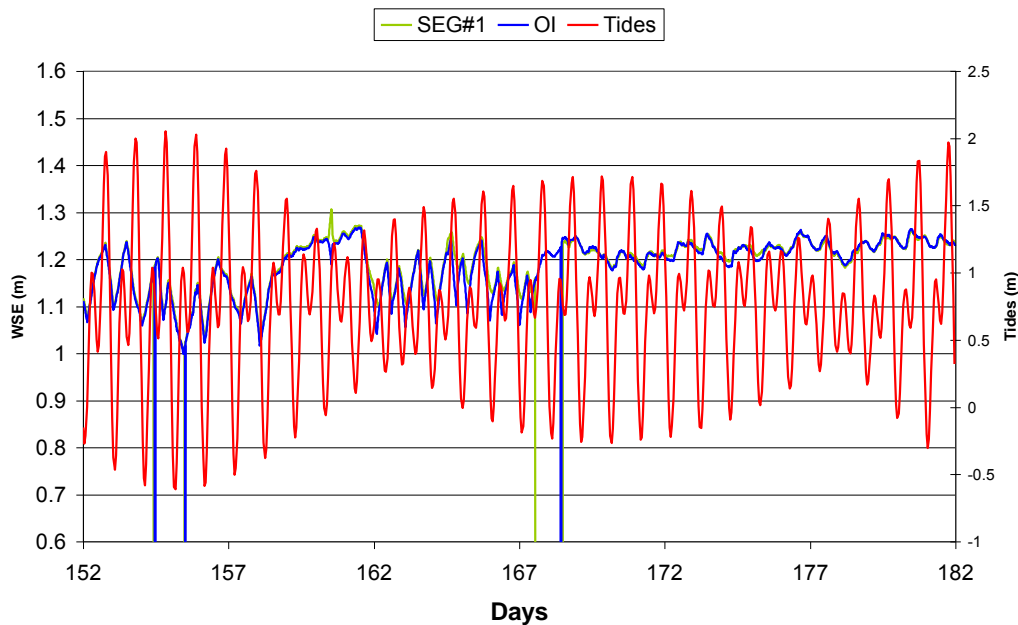


Figure 3.8. Comparisons of measured (red) and modeled (blue for bottom and green for surface layer) (a) temperature at OI for Jan, 2008, (b) temperature at OI for Apr, 2008, (c) temperature at SEG1 for Jan, 2008, and (d) temperature at SEG1 for Apr, 2008.

### 3.2.2 Dry Season (May–October 2008)

During this dry season, the inlet was closed and the surface water exchange of the slough water and ocean water ceased. The slough functioned like a pond, receiving and accumulating water that flowed in from the upstream watershed. An examination of the measured WSE (Figure 3.9) shows that the slough water maintained relatively constant water surface level during the entire dry season with some small fluctuations which are in line with the tidal height. Since there is no apparent sink for the slough water, except evaporation and seepage through the sand barrier at the OI, the continuous freshwater inflows did not result in obvious increase of WSE in the slough. A close examination of the field data is needed in order to better understand the source-sink balance and possible reason(s) for the phenomena.



**Figure 3.9. Water surface elevation in Loma Alta Slough during the dry season (ocean tides are in red for comparison).**

To account for the possibility of seepage, we observed that measured WSE data at OI have oscillations which are in line with the tidal fluctuation in frequency. The average amplitudes of these oscillations are ~3 to 5 cm, all less than 10 cm. Very likely, temporal variations of water surface elevation during the dry season result from the water seepage and exchange through the sand barrier during tidal cycles (same fluctuation frequency). It is estimated that during each tidal cycle, a total of ~500 m<sup>3</sup> of water is exchanged between the ocean and the slough, which is equivalent to an average of 0.4 to 0.8 mm sec<sup>-1</sup> of seepage velocity through the sand barrier during the 12 hour period, which is in the reasonable conductivity range of 0.3 to 1.0 mm sec<sup>-1</sup> for groundwater seepage through sand.

The order of magnitude analysis for the source and sink terms helps to identify possible reason or explanation for the behaviors of measurements and model results. More field data is needed to validate the assumptions made for the analysis. Another possibility is associated with the uncertainty in using the

measured discharge data as our boundary condition. This include two possibilities, one being the measured discharge data has errors or bias and the other being there is un-identified sink/loss term between the model's upstream boundary condition grid cell and the ME station where the discharge data were measured.

We have discussed and analyzed the significance of an accurate estimation of flow rates during the wet and, in particular, the dry seasons. With EFDC, the hydrodynamics of the slough water during the dry season is near stagnant with minimum freshwater inflows. The minimum freshwater inflows are balanced with evaporation, which is estimated to be less than  $1 \text{ cm day}^{-1}$ , and tidal exchange with the ocean water by seepage through the sand barriers near the OI station. Presently, EFDC cannot handle such seepage flows with tidal stages. Modification of the code would be required to simulate this process.

#### *Analysis of Overtopping of Ocean Water*

During the dry season, the slough was closed by the elevated sand berm, which separated and prohibited the exchange between the ocean water and the slough water. The closing date is not clear was estimated to have taken place between May 15 and 23, 2008. During the closure, the slough continued to receive dry season base flow from the watershed, however, the slough water elevation remained at relative constant height, which should result from the balance among the freshwater base flow from the watershed, evaporation and seepage between the ocean and slough through the sand berm. The measured average water surface elevation is about 1.2 m based on NAVD, which is almost identical to the water surface elevation during the low tide when the slough was open. As such the water surface elevation of 1.2 m seemed to be at equilibrium during both wet and dry season, that is the water surface elevation of the slough tends to maintain at relative constant heights, except during high tides when the slough was open.

Figure 3.10 shows both measured and simulated salinities during the period of Jan 1-July 19, 2008. While simulated salinities match well with the measurement during Jan-April 30 when the slough was open, simulated salinities resembled to measured salinities during the slough closure period, when the salinities started to decrease rapidly due to dilution from the watershed dry base flow with no saline water exchange from the ocean. During June 4 and July 4, salinities at Ocean Inlet station increased significantly, which coincidentally took place during the two peak spring tides (Figure 3.11). A berm height of 1.54 m is obtained through calibration to best match salinities between the model and measurement. As such, it is estimated the berm height was around 1.54 m during June 4 and July 4, and possibly the rest of the closure period of 2008. With the calibrated sand berm height of 1.54 m, simulated salinities match well with the measurements.

Figure 3.14 shows tidal heights relative to NAVD during Jan-Oct 2008 with three references, including the existing condition with the sand berm height of 1.54 m and Mean Lower High Water of 1.04 m, both relative to NAVD. These references will be used for managerial scenarios runs for bacteria study, which will be discussed in the next section.

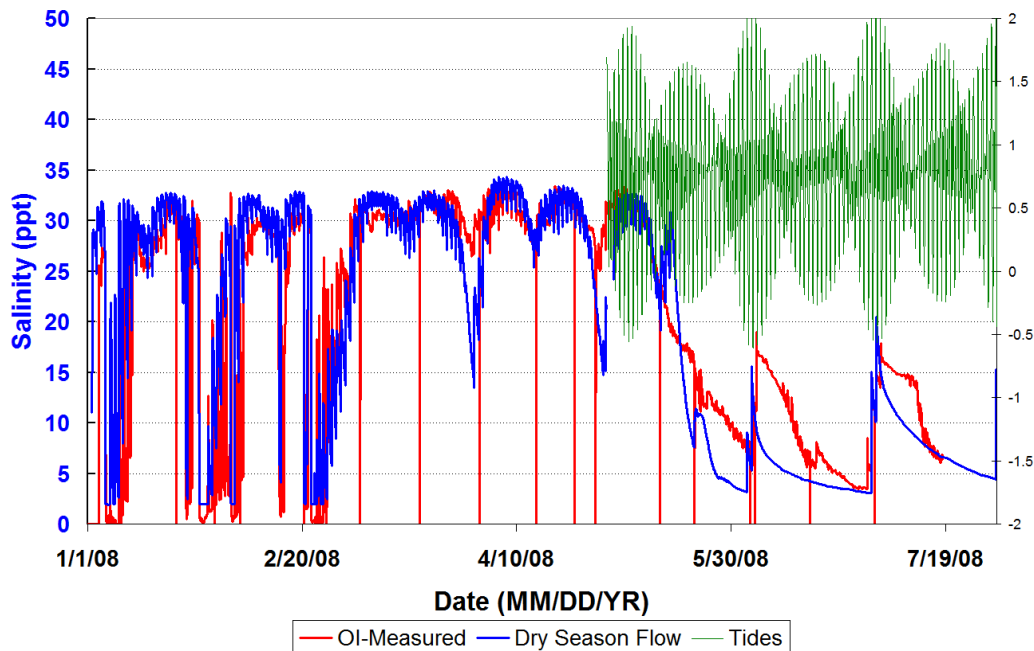


Figure 3.10. Measured and simulated salinities during slough open period (Jan-Apr 2008) and slough closure period (May 15-July 30, 2008) with tides plotted in the background.

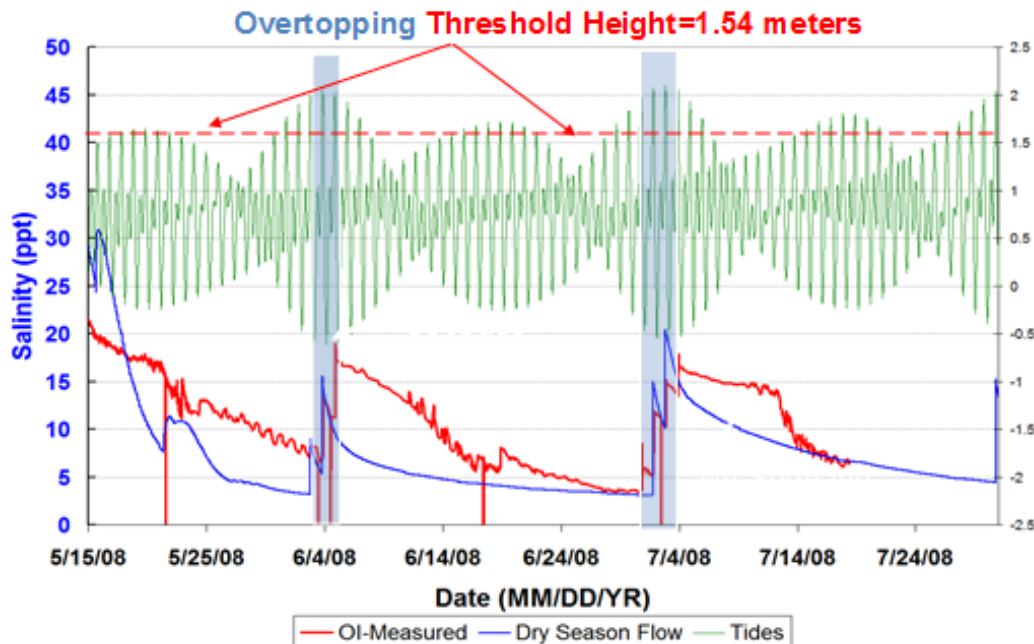
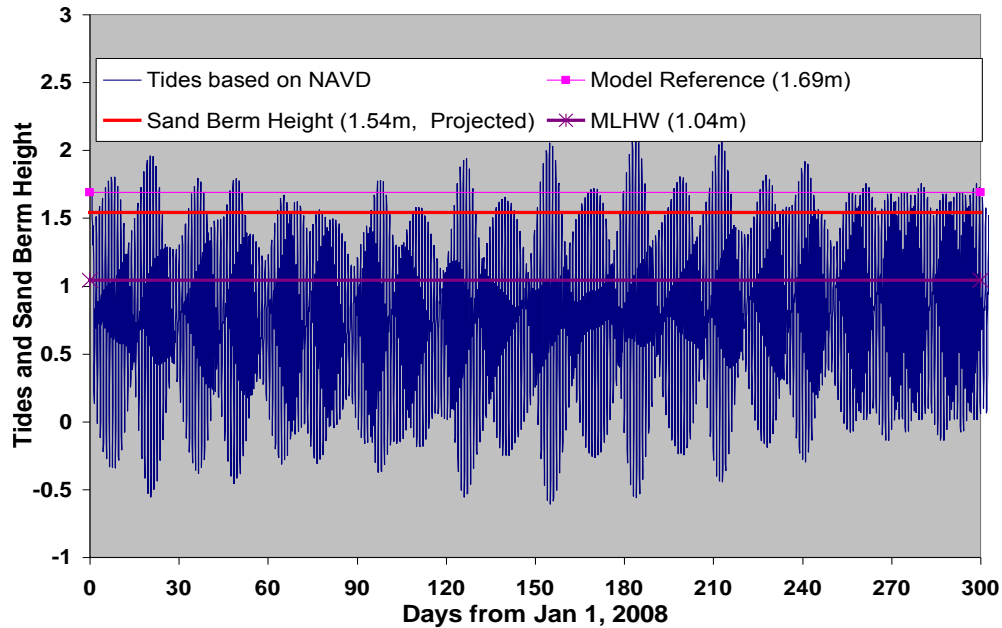


Figure 3.11. Close-up comparison between simulated and measured salinities and tides during the closure period. Salinities peaked up during June 4 and July 4 from overtopping of the tides and sand berm of 1.54 m is obtained by calibration.



**Figure 3.14. Tides during Jan-Oct 2008 with references to 1) NAVD, 2) Model reference (1.69 m), 3) Existing sand berm height during slough closure (1.54 m), and 4) Mean Lower High Water (MLHW).**

### 3.3 Estuary Hydrodynamic Modeling Uncertainties

Uncertain in estuary hydrodynamic modeling arises from several factors. This section summarizes these uncertainties.

Overall, uncertainty in model performance is low. For example, measured versus observed WSE showed a model fit of  $R = 0.96$ , with a slope of 1.003, indicating less than 1% error.

Uncertainty in dry weather flows from the watershed is another source of uncertainty. This uncertainty was addressed with additional monitoring conducted in 2010. However, it should be noted that utilization of 2010 data in the calibration of 2008 hydrology and water quality results introduces unquantifiable uncertainty.

Berm height is variable in the Slough, arising from the combination of natural forcing of freshwater flow versus. Our solution to choose fix berm heights representative of the calibration and validation periods is an acceptable solution to a modeling problem, but the lack of data on the average berm height over periods of years, particularly during wet weather and winter dry weather is a source of uncertainty to results. This uncertainty is not quantifiable.

Exchange of the Slough water with the ocean through the sand berm and with groundwater is also another source of uncertainty in the modeling. Using existing data, we were able to achieve good model validation. However, the net effect of ocean and groundwater exchange on the Slough water quality (FIB and nutrients) is not quantifiable. These uncertainties are discussed in later sections of the report.

### **3.4 Summary of Estuary Hydrodynamic Modeling**

Simulation of water surface elevation, salinity and temperature illustrate that the hydrodynamic model is working well during wet weather, winter dry weather (when the mouth is open) and summer dry weather (when the Slough mouth is closed). The good performance of the hydrodynamic model provides us with a measure of confidence to use the model for water quality applications.



## 4 ESTUARY BACTERIA MODEL CALIBRATION AND VALIDATION

This section summarizes the development, calibration, and validation of the estuary bacteria model for Loma Alta Slough. This includes identification and description of the data that were utilized for the model, as well as the approach that was followed for constructing, calibrating, and verifying the model for Loma Alta Slough.

### 4.1 Methods

#### 4.1.1 Data Sources

##### Model Inputs

Loma Alta Creek is the major source of freshwater discharging to LAS. Groundwater inputs are unquantified. Flow data modified based on calibration using salinity data were used to calibrate and validate the wet weather watershed loading model (Section 2) and to quantify the daily dry weather average flow into the LAS (see Section 3 for discussion). Flow data, temperature, conductivity, bacteria (enterococcus, fecal coliform, total coliform), and total and dissolved inorganic nitrogen and phosphorus, and biological oxygen demand were obtained from Mactec (2009), data collected in support of the SDRWQCB Monitoring Order # R9-2006-0076 for Loma Alta Slough and other 303(d) listed estuaries. Discharge data measured at ME station were used to drive the EFDC hydrodynamic simulations for both the wet period (1/1/2008-4/1/2008) and dry period (5/1/2008-10/21/2008). Salinity and temperature measured at ME station were used as the riverine boundary conditions.

##### Slough Bacteria Concentrations

Slough enteric bacteria concentrations (enterococcus, fecal and total coliform) used for model calibration and validation were derived from Mactec (2009) for three wet weather events (January 5, January 24, and February 4 of 2008) and five index periods in Loma Alta Slough:

- Jan 14, 15, 16
- Feb 7, 8, 21
- Mar 24, 25, 26, 31
- Apr 1 (2 samplings), 17
- October 7, 8, 9, 13, 14, 15

Concentrations of bacteria were measured at ME station and the slough stations at Segment 1 and Ocean Inlet during both the wet weather conditions (precipitation greater than 0.1 in during 72 hours) and the dry weather condition (precipitation less than 0.1 in during 72 hours).

## 4.1.2 Model Development

### Boundary Conditions

There are two boundaries for the model grid, the upstream boundary and downstream ocean boundary (Figure 3.2). The upstream boundary (Segment Station #28) receives freshwater inflows and bacteria loads from the watershed. For this study, modified freshwater discharges calibrated to match salinity in the Slough were utilized during 1/1/2008-10/31/2008 as input at the river boundary. When using empirical concentrations to compare against modeled output, concentrations of bacteria are multiplied by discharge to obtain bacteria loads from the watershed. Bacteria concentrations assigned to "nearest neighbor" months when no data were available (rather than a linear interpolation). The modified flow data were used to make these calculations. These bacteria loads are assigned as boundary conditions for freshwater loads entering the Slough.

### Model Parameterization -Bacteria

In general, bacteria, including the three species of Enterococci, Fecal Coliform and Total Coliform, are not conservative substance, they die with die-off rates as a function of salinity, temperature and solar light. In most modeling studies, the die-off rates empirically obtained by Mancini (1976) have been used widely. Mancini's equation can be expressed by the following equation:

$$K = (0.8 + 0.006S)1.07^{T-20} + \frac{I_0}{K_e H} (1 - e^{-K_e H})$$

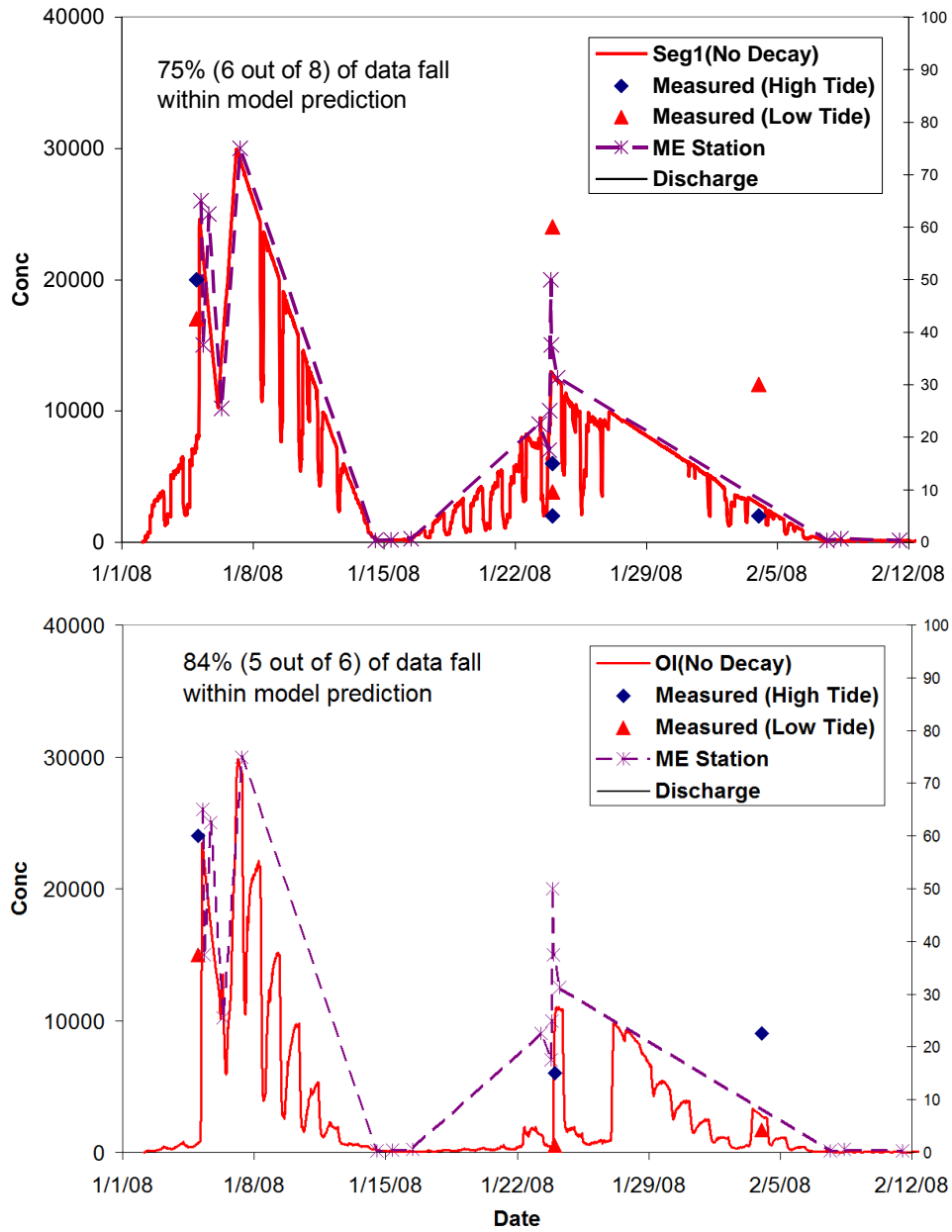
where S is the % of sea water, T is the temperature.  $I_0$  is the sunlight energy at water surface ( $\text{Cal cm}^{-2} \text{ hr}$ ),  $K_e$  is the light extinctive coefficient and H is the water depth.

Macini's equation was obtained empirically using a large amount of bacterial datasets. In spite of the fact that it contains a high level of uncertainty, it is the most commonly used formula for bacterial die-off rates. For this study, the stakeholders and SDRWQCB decided that the three bacteria species should be treated as conservative substances, meaning that the die-off rates should be assumed to be zero. The EFDC code was implemented to simulate the three bacteria species as conservative substances. Boundary conditions were assigned with the bacteria concentrations measured at the ME station. Bacteria die-off rate was turned off (set to zero).

## 4.2 RESULTS AND DISCUSSION OF BACTERIA SIMULATION MODEL

### 4.2.1 Model Calibration for Wet Weather

Simulated bacteria concentrations were compared with measured values at Segment 1 and Ocean Inlet stations during the wet weather conditions (Figure 4.1 through Figure 4.3). Concentrations measured at ME station (loading) were also used for comparison.



**Figure 4.1. Model/measurement comparisons for enterococci during the 2008 wet weather at Segment 1 (above) and Ocean Inlet (bottom).**

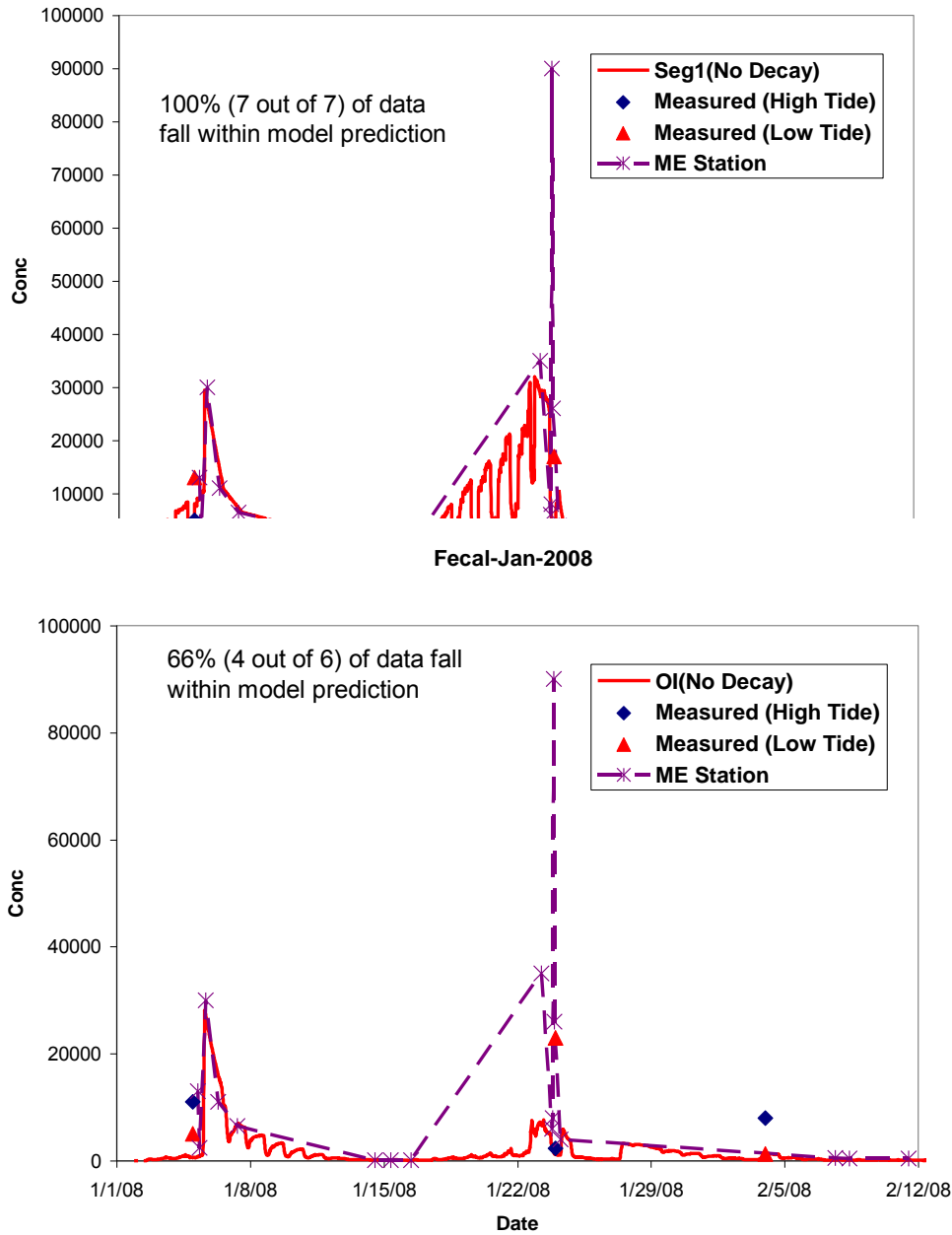
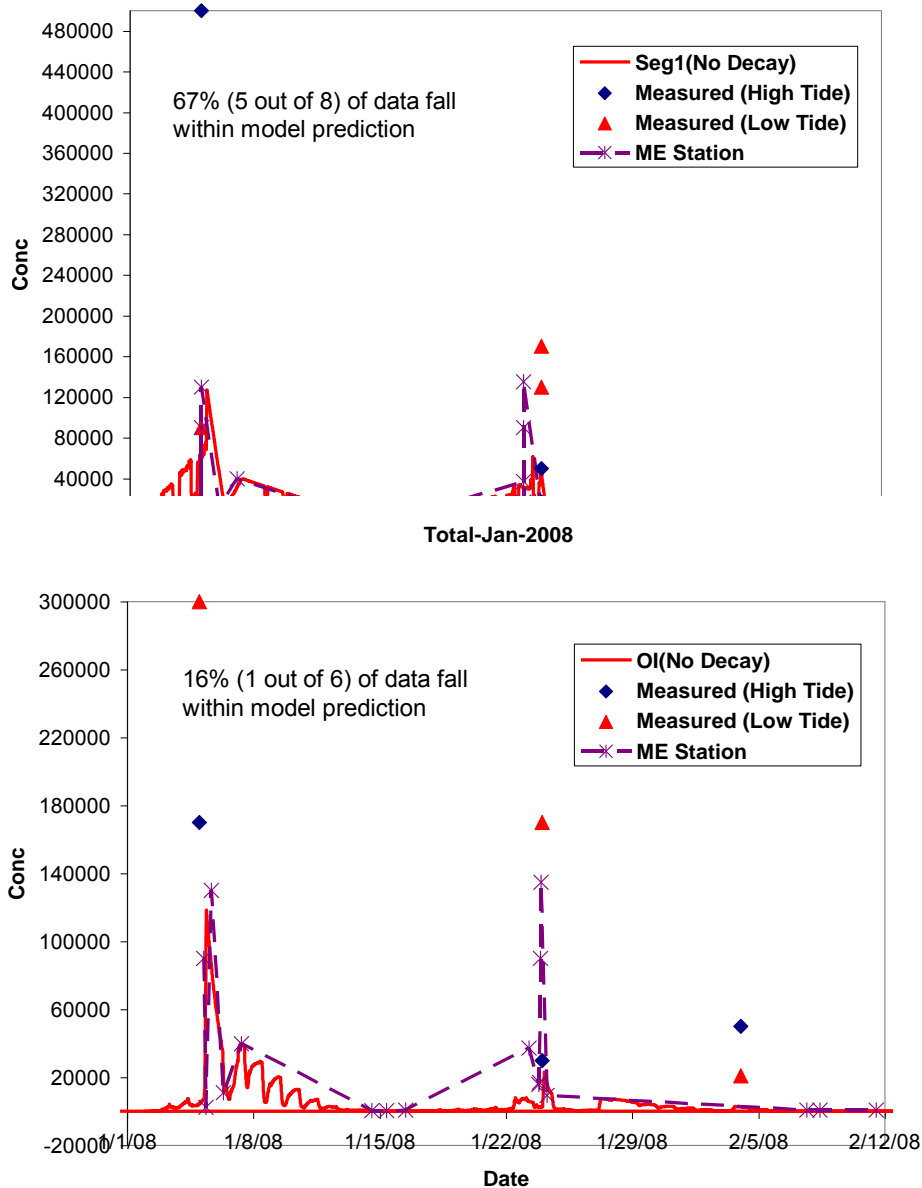


Figure 4.2. Model/measurement comparisons for fecal coliform during the 2008 wet weather at Segment 1 (above) and Ocean Inlet (bottom).



**Figure 4.3. Model/measurement comparisons for total coliform during the 2008 wet weather at Segment 1 (above) and Ocean Inlet (bottom)**

Results show that during the wet weather of November 2007–October 2008, bacteria loads from the watershed constituted the major source that were flushed downstream. Bacteria concentrations in the slough were close to the loading concentrations measured at the ME station. This is reflected by the simulated results showing that 71 % of the measured bacteria concentrations during wet weather are within the model predicted range, which indicates strong diurnal variations resulting from interactions of strong freshwater flows and flushing from the ocean water. In total, 12 out of 42 field data are outside of the model range. Results show that additional bacteria sources may exist near the Ocean Inlet

station, since some of the measured concentrations at the 12 “out of range” data points are higher than load concentrations measured at ME stations, which violates the assumption that upstream load is the only source. Therefore, more future work is needed to better identify and quantify the “additional source” which is unknown.

#### 4.2.2 Model Calibration for Dry Weather

In contrast to the wet weather, data were measured more frequently during dry weather (Table 4.1). Simulated bacteria were compared with measurements for Segment 1 station (Figure 4.4) and Ocean Inlet station (Figures 4.5), respectively. Model appears to be performing adequately for prediction of dry weather bacteria concentrations. Simulated bacteria concentrations compare well at Seg#1 for all the scenarios. Simulated bacteria concentrations under predicted at OI for most index periods. This is consistent with the results from wet weather study, for which underprediction by the model suggest that additional source(s) may be present. In addition, it should be reminded that model predictions are based on model grid resolution, meaning that concentrations are assumed to be uniform within each model grid cell, which is about 30mX40m in size on average. Measurements are based on water samples taken at specific locations, and therefore, difference may exist due to the uniformity of the model prediction versus measurement at fixed point.

**Table 4.1. Summary of validation data for wet weather bacteria concentrations.**

	Total Number of Samples	Measured Data within Simulated Daily Range
<b>Segment 1 Station</b>		
<b>Enterococci</b>	<b>8</b>	<b>75%</b>
<b>Fecal Coliform</b>	<b>8</b>	<b>100%</b>
<b>Total Coliform</b>	<b>8</b>	<b>67%</b>
<b>Ocean Inlet Station</b>		
<b>Enterococci</b>	<b>6</b>	<b>84%</b>
<b>Fecal Coliform</b>	<b>6</b>	<b>66%</b>
<b>Total Coliform</b>	<b>6</b>	<b>16%</b>

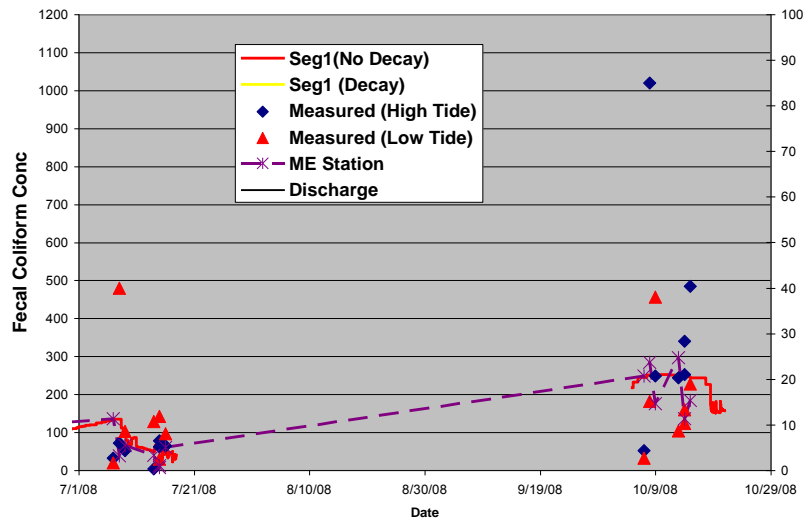
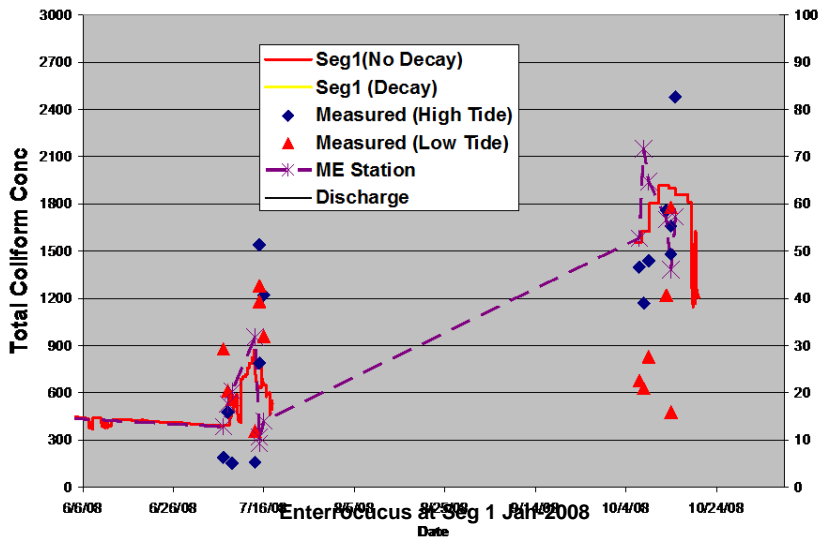
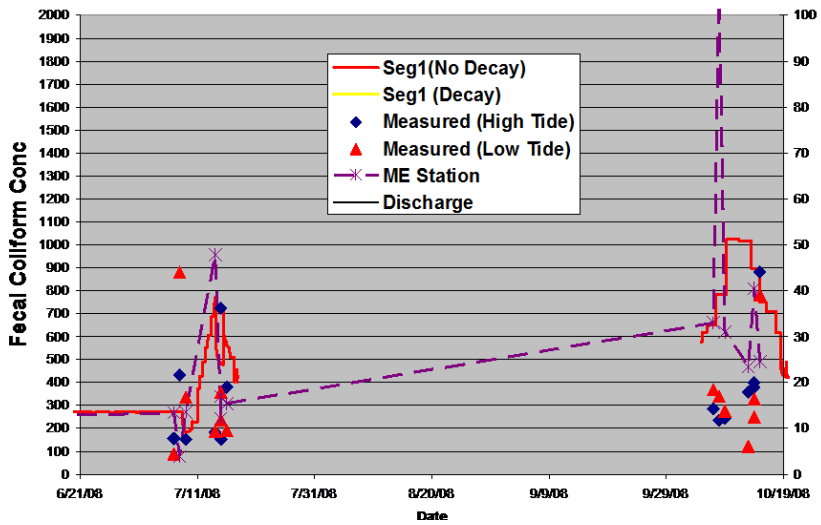


Figure 4.4. Model/measurement comparisons of fecal coliform (top), total coliform, enterococcus at Segment 1 for the 2008 dry season).

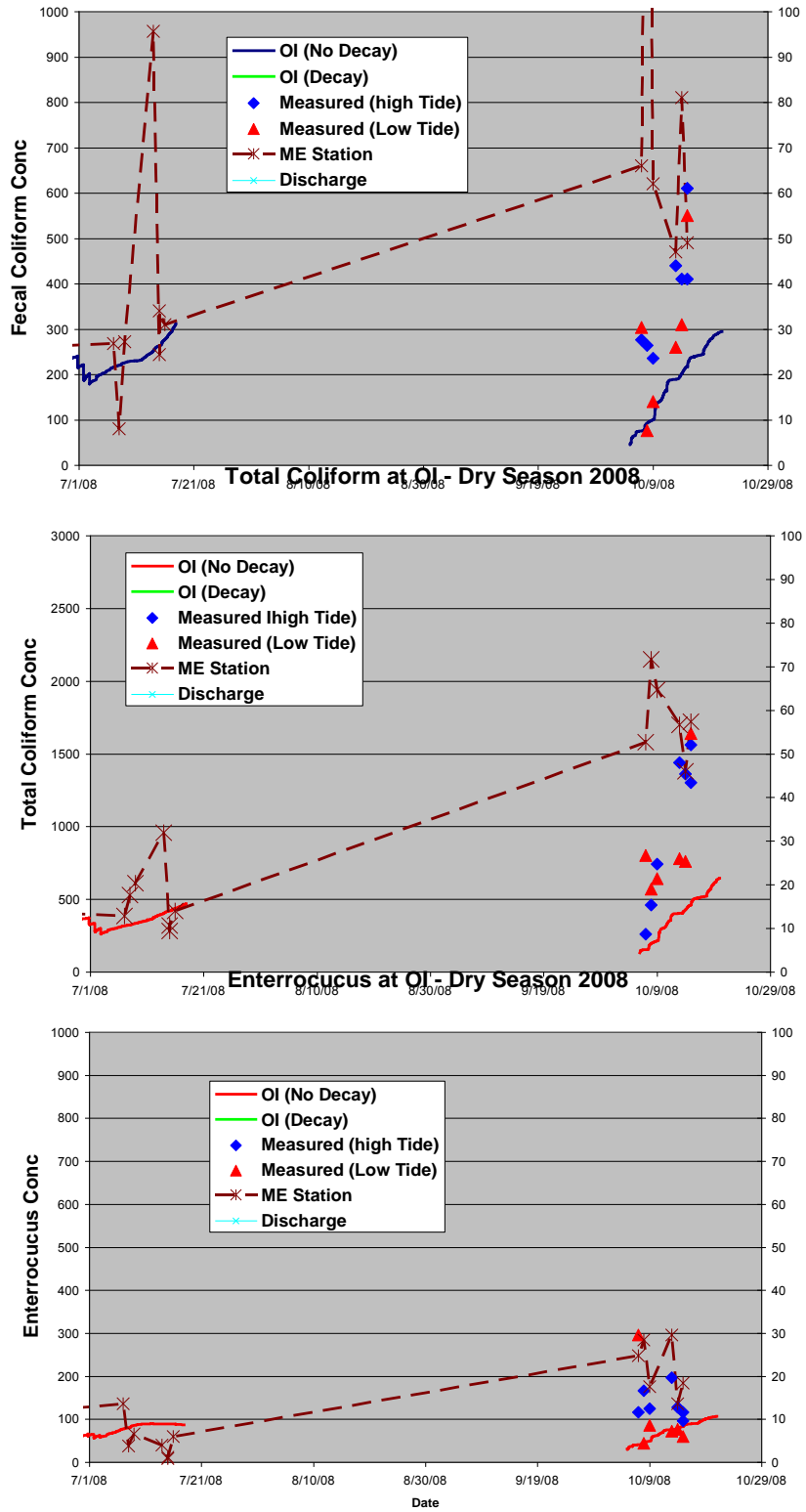


Figure 4.5. Model/measurement comparisons of Fecal coliform, total coliform and enterococcus at Ocean Inlet for the 2008 dry season.



### **4.3 Uncertainties in Bacteria Simulation Modeling**

Uncertainties in bacteria simulation modeling come from two major factors.

First, the frequency of wet (3 storms) and dry weather (4 index periods) FIB load monitoring was low. The use of either modeling results or empirical data as boundary conditions to the Slough modeling study introduces uncertainty because bacteria concentrations are known to be highly variable over time, either as a function of storm event or during dry weather conditions.

The second source of uncertainty arises from the indication that, while the MES loading explains the majority of variability in Slough FIB concentrations, there appears to be an additional source to the Slough. This will likely cause the model to underpredict the number of exceedance days relative to TMDL numeric targets.

### **4.4 Summary of Bacteria Simulation Modeling**

Simulation of bacteria during wet weather and dry weather illustrate that: 1) the FIB water quality model is performing adequately during wet and dry weather conditions and 2) watershed loads explain the majority of the measured variability in Slough FIB bacteria. During wet weather, Slough FIB concentrations closely approximated that of the MES, but approximately 33% of grabs over 3 storms were outside of modeled range, indicating that an additional bacteria sources may exist near within the lower Creek or within the Slough. A similar result was found during dry weather, particularly within the ocean inlet station. Therefore, more future work is needed to better identify and quantify this “additional source”.

## 5 ESTUARY EUTROPHICATION MODEL CALIBRATION AND VALIDATION

This section summarizes the development, calibration, and validation of the estuary eutrophication model for Loma Alta Slough. This review includes identification and description of data that were utilized for the model, as well as the approach that was followed for constructing, calibrating, and verifying the model for Loma Alta Slough.

### 5.1 Methods

#### 5.1.1 Data Sources

##### Inputs

Loma Alta Creek is the major source of freshwater discharging to LAS. Groundwater inputs are unquantified. Flow data modified based on model calibration using the salinity data were used to calibrate and validate the wet weather watershed loading model (Section 2) from January through April 2008. New flow data were used to substitute modified flow data from May through October 2008. Total and dissolved inorganic nitrogen and phosphorus, and biological oxygen demand were obtained from Mactec (2009), data collected in support of the SDRWQCB Monitoring Order for Loma Alta Slough and other 303(d) listed estuaries. When using empirical concentrations to compare against modeled output, concentrations of wet and dry weather nutrients are multiplied by discharge to obtain bacteria loads from the watershed. Concentrations were assigned to "nearest neighbor" months, rather than employing linear interpretation, when no data were available. These nutrient loads are considered boundary conditions for freshwater inputs entering the Slough.

##### Slough Continuous Water Quality Data

Data from *in situ* instruments deployed by Mactec (2009) at two stations in Segment 1 and at the Ocean Inlet stations were used to simulate dissolved oxygen within the Slough.

##### Slough Nutrients and Eutrophication

Within Slough concentration of total and dissolved inorganic nitrogen and phosphorus during the three wet weather events and four dry weather index periods were taken from Mactec (2009). Macroalgal biomass and percent cover, benthic fluxes of nutrients, and denitrification rates during the four index periods were taken from McLaughlin et al. (2010);

Table 5.1).

**Table 5.1. Summary of the timing of data collection for eutrophication in Loma Alta Slough by time period, types of sampling event, and organization**

Period	Event	Organization	Date
Wet Weather Monitoring	Storm Sampling (3 storm events)	MACTEC	1/5-1/7/08 1/23-1/24/08 2/3-2/4/08
Wet Weather Monitoring	Post Storm Sediment Sampling	MACTEC	1/14/08
Continuous Monitoring	Water Quality Monitoring	MACTEC	1/1/08- 10/21/08
Index Period 1	Ambient Sampling	MACTEC	1/14-1/16/08, 2/7- 2/8, 2/11/08
	Transect Sampling	MACTEC	1/14/08
	Benthic Chamber Study	SCCWRP	1/10/08
	Porewater Peeper Deployment	SCCWRP	1/7-1/21/08
	Sediment Core	SCCWRP	1/21/08
	Macroalgae Monitoring	UCLA	1/7-1/21/08
Index Period 2	Ambient Sampling	MACTEC	3/24-3/26/08, 3/31-4/1/08, 4/7/08
	Transect Sampling	MACTEC	3/24/08
	Benthic Chamber Study	SCCWRP	3/20/08
	Porewater Peeper Deployment	SCCWRP	3/18-4/3/08
	Sediment Core	SCCWRP	4/3/08
	Macroalgae Monitoring	UCLA	3/18-4/3/08
Index Period 3	Ambient Sampling	MACTEC	7/7-7/9/08, 7/14-7/16/08
	Transect Sampling	MACTEC	7/8/08
	Benthic Chamber Study	SCCWRP	7/7/08
	Porewater Peeper Deployment	SCCWRP	7/3-7/23/08
	Sediment Core	SCCWRP	7/23/08
	Macroalgae Monitoring	UCLA	7/3-7/23/08
Index Period 4	Ambient Sampling	MACTEC	10/7-10/9/08, 10/13-10/15/08
	Transect Sampling	MACTEC	10/7/08
	Benthic Chamber Study	SCCWRP	9/15/08
	Porewater Peeper Deployment	SCCWRP	9/12-9/29/08
	Sediment Core	SCCWRP	9/29/08
	Macroalgae Monitoring	UCLA	9/12-9/29/08

### 5.1.2 Supplemental Data Sources for Calibration and Validation

Two supplemental data sources were also used to improve our modeling studies of dissolved oxygen in the Slough. This section describes these two additional data sources.

After field data collection was completed in 2008, analysis of dissolved oxygen data illustrated chronic hypoxia and anoxia in Slough bottom waters. SCCWRP identified the need for additional DO data collection in the Slough to improve understanding of the vertical profile of DO in the Slough. City of Oceanside contracted with Merkel and Assoc. to collect continued dissolved oxygen concentrations in the surface and bottoms waters of Segment 1 and Segment 2 (Merkel 2010). These 2010 data were used to compare model output from the equivalent month in 2008 to better understand to what extent the model was representing DO conditions in the Slough, albeit during a different year and presumably algal conditions.

The second data set were collected by EPA Region 9 (Tetra Tech 2013) during 24 hours (2 days) of Aug 6-7,2012 for the purposes of better quantifying BOD, nutrient and DO loading to the Slough at a site just upstream of the estuary. These hourly data during Aug 6-7, 2012 were used to test whether Slough simulations of dissolved oxygen differed as a result of using these data.

### 5.1.3 Model Development

The EFDC hydrodynamic model was run at every one second over Jan-Oct 2008. Hydrodynamic and transport results, including water volume, current velocity, salinity and temperature of each model segment were stored at every two seconds as the .hyd file. The .hyd file was linked within the water quality model, WASP7.1, to drive the transport and water quality kinetics for the simulation of Jan-Apr 2008, the period when the inlet was open, and May-Oct 2008, the period when the inlet was closed.

The eutrophication sub model, EUTRO, was used for the Water Analysis Simulation Program (WASP 7.1). It is the recommended EPA standard model for dynamic water quality analysis and is supported and updated by the U.S. EPA Center for Exposure Assessment Modeling in Athens, GA and Region IV in Atlanta, GA. EUTRO simulates key processes, and the interactions among them, governing eutrophication and dissolved oxygen. A total of eight variables, including ammonia, nitrate and nitrite, organic nitrogen, orthophosphate, organic phosphorus, carbonaceous biological oxygen demand, phytoplankton and dissolved oxygen (Figure 5.1). These variables and the associated processes constitute four interacting systems, including phytoplankton kinetics, nitrogen cycle, and phosphorus cycle and dissolved oxygen.

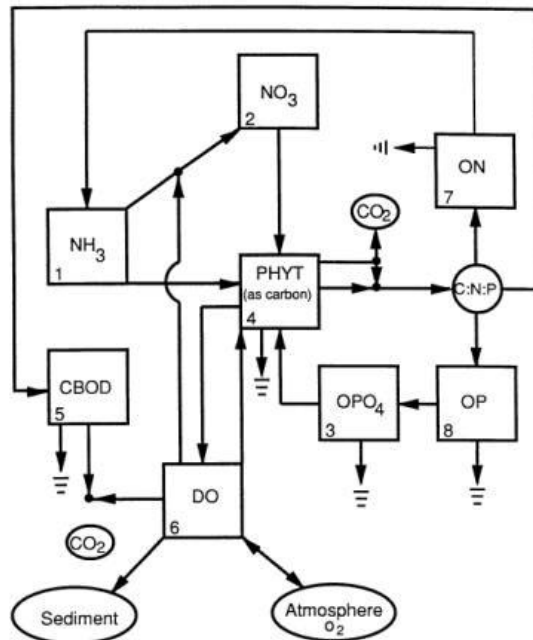


Figure 5.1. Processes and state variables simulated in the WASP 7.1 model.

WASP 7.1 uses the same model grid as that for EFDC, with the same boundary loading cells. Water quality loads measured at the ME station were assigned at the upstream boundary for the WASP 7.1 model. Figure 5.2 shows the time series of four water quality variables. The loading data were measured sparsely over the Nov 2007-Oct 2008 period, with only two sets of measurement during the May-Oct 2008 period when the inlet was closed, which is also the period for model simulation. Loadings were linearly interpolated among the measured data.

Table 5.2 shows key parameters used in the WASP7 model. Since site specific data are not available, most of these parameters are obtained from published literature (Wang et al. 1998).

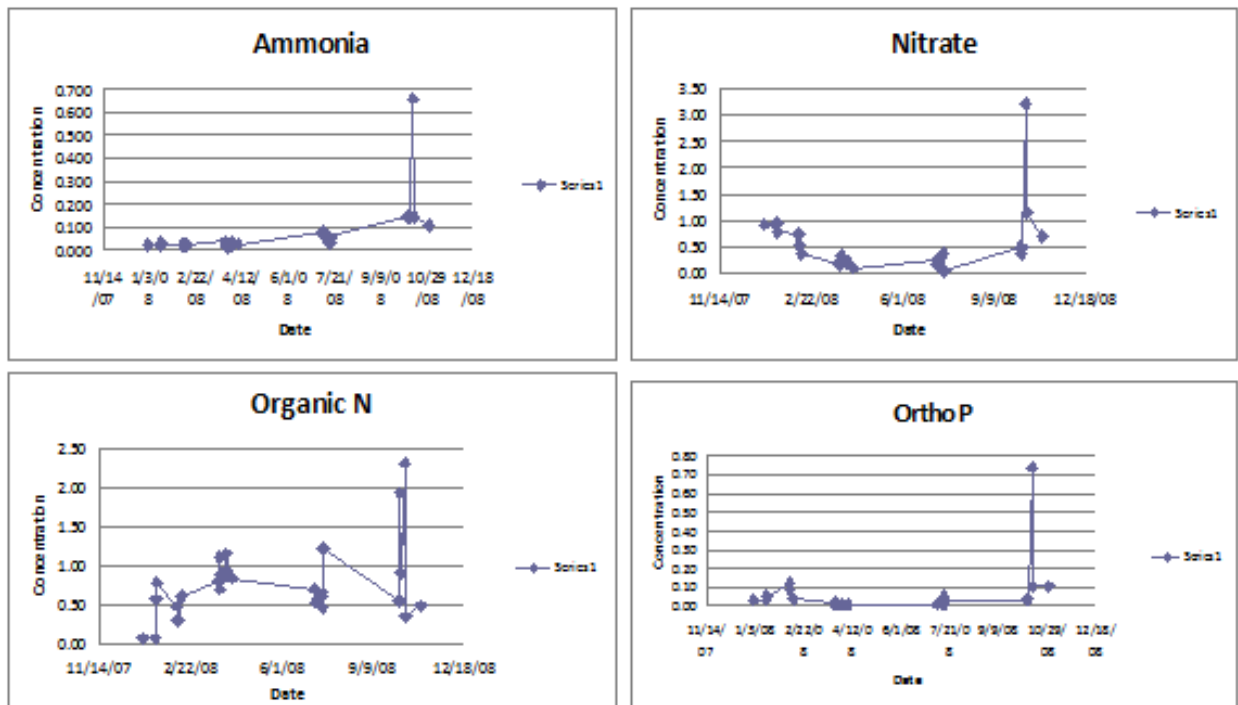


Figure 5.2. Loading concentrations measured at ME station.

**Table 5.2. WASP model parameters and values.**

Parameters	Units	Values
Benthic Ammonia Flux	Mg/m <sup>2</sup> /day	0.2
Benthic Phosphorus Flux	Mg/m <sup>2</sup> /day	1
Sediment Oxygen Demand	g/m <sup>2</sup> /day	1
Sediment Oxygen Demand Temperature Correction Factor	Unitless	1.08
Nitrification Rate Constant @20 °C	/day	0.15
Nitrification Temperature Coefficient		1
Half Saturation Constant for Nitrification Oxygen Limit	Mg-O/L	1
Denitrification Rate Constant @20 °C	/day	0.09
Denitrification Temperature Coefficient	Unitless	1.08
Half Saturation Constant for Denitrification Oxygen Limit	Mg-O/L	0.1
Dissolved Organic Nitrogen Mineralization Rate Constant @20 °C	/day	0.005
Dissolved Organic Nitrogen Mineralization Temperature Coefficient	Unitless	1.02
Mineralization Rate Constant for Dissolved Organic P @20 °C	/day	0.03
Dissolved Organic Phosphorus Mineralization Temperature Coefficient	Unitless	1.02
Phytoplankton Maximum Growth Rate Constant @20 °C	/day	1.8
Phytoplankton Growth Temperature Coefficient	Unitless	1.07
Phytoplankton Self Shading Extinction (Dick Smith Formulation)	Unitless	0.017
Phytoplankton Carbon to Chlorophyll Ratio	Unitless	30
Phytoplankton Half-Saturation Constant for Nitrogen Uptake	Mg-N/L	0.025
Phytoplankton Half-Saturation Constant for Phosphorus Uptake	Mg-P/L	0.001
Phytoplankton Endogenous Respiration Rate Constant @20 °C	/day	0.08
Phytoplankton Respiration Temperature Coefficient	Unitless	1.07
Phytoplankton Death Rate Constant (Non-Zooplankton Predation)	/day	0.01
Phytoplankton Phosphorus to Carbon Ratio	Unitless	0.025
Phytoplankton Nitrogen to Carbon Ratio	Unitless	0.1
Phytoplankton Maximum Quantum Yield Constant	Unitless	720
Phytoplankton Optimal Light Saturation	Unitless	200
Oxygen to Carbon Stoichiometric Ratio	Unitless	2.67

#### 5.1.4 Model Simulations

Simulations were conducted for May 1-Oct 31, 2008. Simulated time series were produced for dissolved oxygen, nutrient concentrations, and macroalgal biomass and compared with measured values. Measured DO data are at every 15 minutes, which were processed with a 24-hour running window to remove the diurnal oscillations. Model simulation results are at every 1.2 hours. There were no measurements during Jun 2008 for Segment 1 and during Jul-Sep 2008 at OI.

Simulations were conducted with new data acquired by Tetra Tech just upstream of the head of estuary, with the intent that these data would be more representative of the true inputs into Slough. These data

consistent of hourly measurements from August 6 midnight to August 7 23:00, 2012. These new boundary data includes DO, BOD, and nutrients. Simulations of DO with the 2012 boundary condition were conducted and compared with those with the 2008 boundary condition. Results are plotted in the same year (2008) for comparison.

## 5.2 Results and Discussion of Eutrophication Model

### 5.2.1 Dissolved Oxygen

Overall, the dissolved oxygen simulations show that the model is not adequately capturing the mean or diurnal variation of measured dissolved oxygen. During the period of Jan-April 2008, the model underpredicted period of non-compliance by approximately 15% at the ocean inlet and overpredicted percentage of non-compliance by 16% at Segment 1 (Table 5.3). During May – October, the model underpredicted percentage of time in non-compliance by 32% in the Ocean Inlet and 20% at Segment 1. Simulated DO concentrations exhibit diurnal fluctuation cycles throughout the dry and wet weather periods, whereas measured DO concentration exhibit diurnal cycle only during the wet weather period, but for dry weather, measured DO show extremely low values over extended periods at both OI and Segment 1 stations.

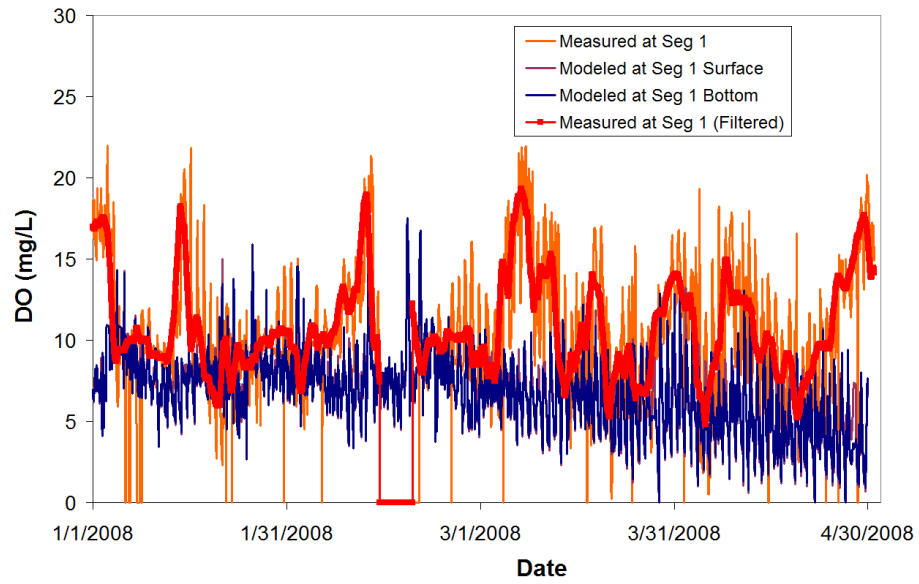
**Table 5.3. Dissolved oxygen model validation: Percentages of time DO <5 mg L<sup>-1</sup> by field and model data Jan-Oct 2008 and Sept-Oct 2010.**

Location	Jan-Apr 2008		May-Oct 2008		
	Field Data	Model	Field Data		Model 2008
			May-Oct 2008	Sep-Oct 2010	
Ocean Inlet	15.1 (bot)	0.01( top) 0.01(bottom)	82.9 (bottom)	No Data	49.1 (top) 49.6 (bottom)
Segment 1	4.2 (bot)	21.2 (top) 21.5 (bottom)	85.7 (bottom)	63.4 (top) 74.9 (bottom)	58.2 (top) 65.4 (bottom)

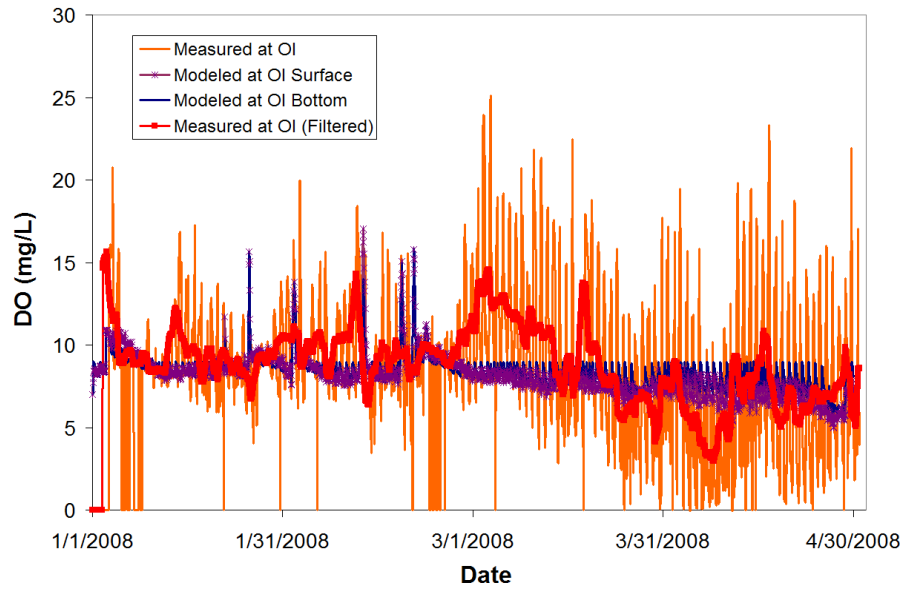
Figures 5.3 and 5.4 show the comparison between model simulation and measurement Segment 1 and Ocean Inlet for the period Jan-May and May-October 2008, respectively. Predicted DO concentrations at the surface layer are higher than those near the bottom. Dissolved oxygen concentrations measured every 15 minutes exhibited strong diurnal oscillation, which reflects the effects of macroalgae on source/sink of DO. Predicted and measured daily DO concentrations. At Segment 1, except during June 2008 when there were no measurements, predicted DO concentrations match well with measured daily DO concentrations in Jul-Sep 2008. Model underpredicted DO concentrations for May 2008 and overpredicted DO concentrations for Oct 2008.



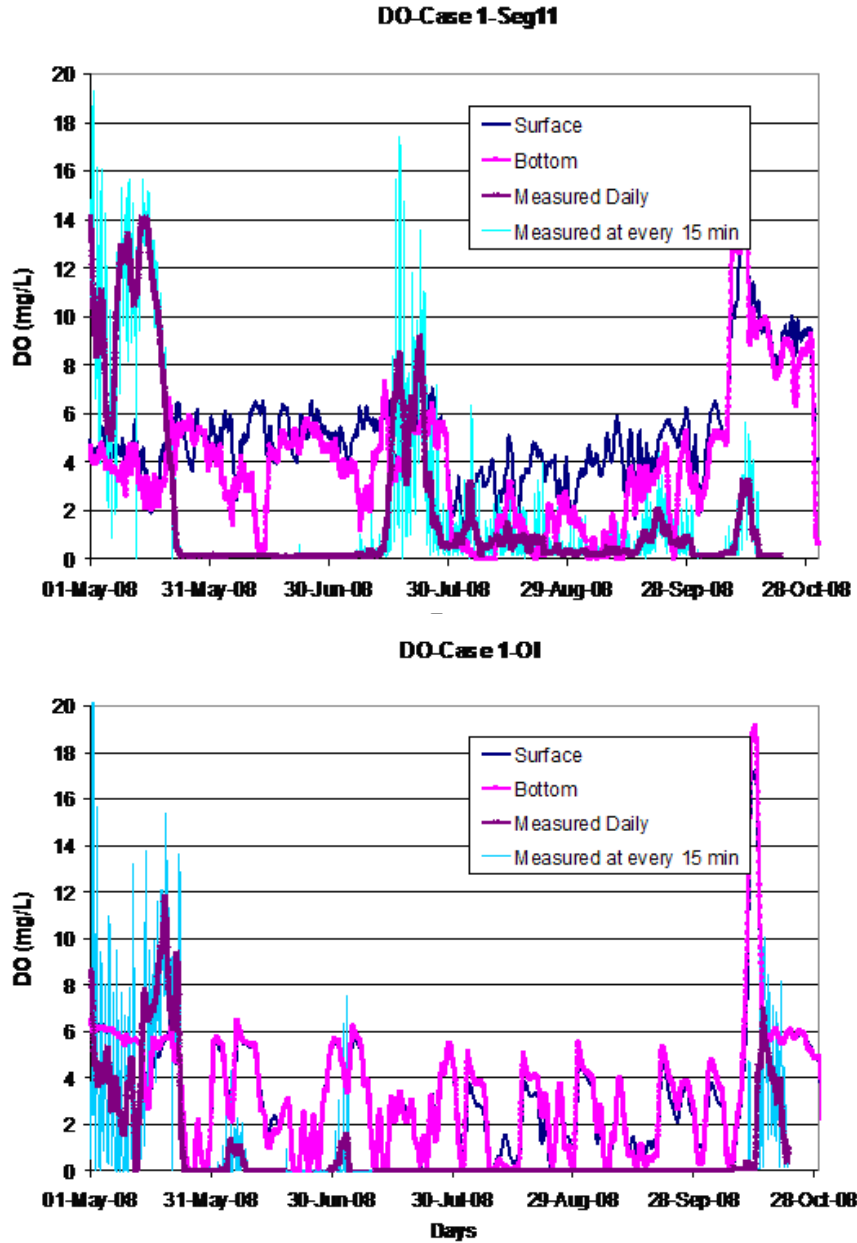
### DO at Seg1



### DO at OI

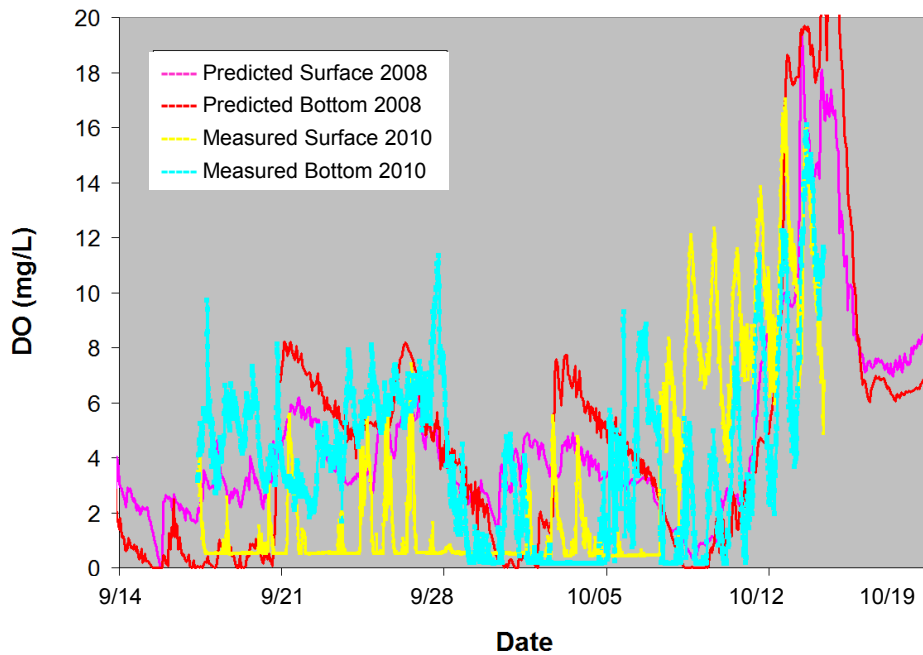
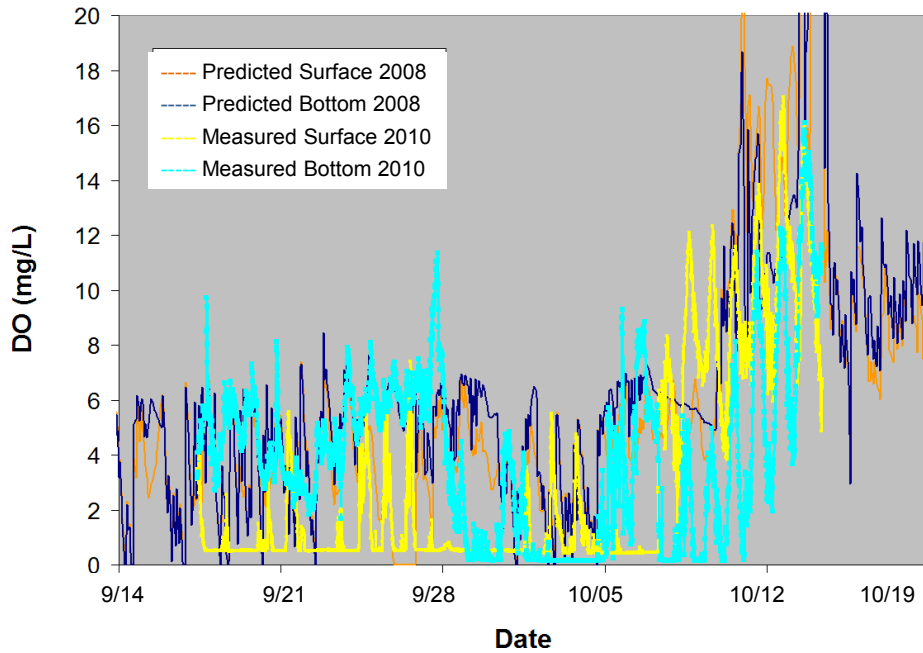


**Figure 5.3. Dissolved oxygen model/data comparison between Segment 1 (top) and Ocean Inlet (bottom) for the period of January-May 2008.**



**Figure 5.4. Dissolved oxygen model/data comparison between Segment 1 (top) and Ocean Inlet (bottom) for the period of May-October 2008.**

Predicted DO concentrations during these two months (and the rest of the period) match well with the external nutrient loadings, which maintained relative low magnitudes May-September 2008 and increased sharply by 5- to 10-fold on October 13, 2008 (Figure 5.5). Component analysis shows the algae photosynthesis constituted a major source for DO and algae respiration a major sink for DO (5.6). Dissolved oxygen is also influenced by loading from two boundaries: upstream loading boundary and re-aeration from the air. The current model structure prevents us from doing a full source/sink analysis of DO.



**Figure 5.5. Comparison of predicted surface and bottom water dissolved oxygen based on 2008 input data with measured surface and bottom water data in 2010 for Segment 1 (top) and Ocean Inlet (bottom).**

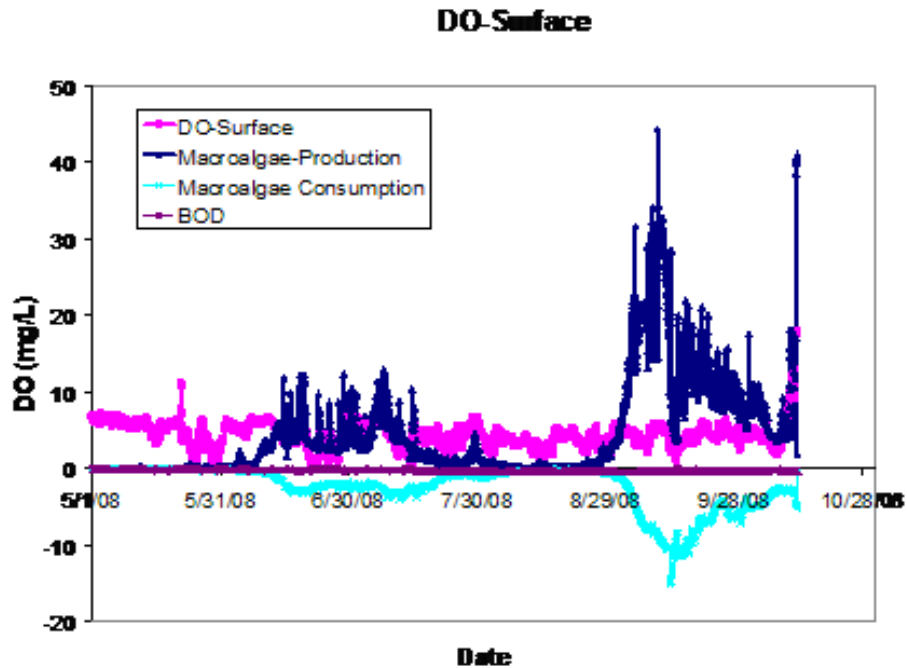


Figure 5.6. Predicted DO concentrations and contributions from macroalgae DO production and consumption and CBOD.

### 5.2.2 Simulations of DO New Boundary Data for August 6-7, 2012

The 2012 boundary DO and BOD concentrations are similar to the 2008 DO data both in diurnal pattern and magnitude with the 2012 DO concentrations slightly larger than the 2008 data (Figure 5.7a and b). The 2012 DO concentrations are higher than the 2008 data by less than  $2 \text{ mg L}^{-1}$  at peaks (oversaturation during the afternoon) and by less than  $1 \text{ mg L}^{-1}$  at troughs (anoxia before dawn or early morning).

Figures 5.8a-d show simulated DO concentrations at Segment 1 and OI for the surface and bottom layers using 2008 and 2012 measured DO data at the boundary. Dissolved oxygen concentrations at Segment 1 are influenced by the boundary conditions, both in timing and magnitude. Since the 2012 DO data were measured only during the 48 hours of August 6-7, simulated DO at Segment 1 are also immediately influenced by the DO forcing at the upstream boundary. Simulated DO concentrations using the 2012 boundary data are higher than those using the 2008 boundary data, with maximum difference less than  $2 \text{ mg L}^{-1}$ , similar to the magnitude of difference between the two sets of boundary DO data.

Compared to DO concentrations at Segment 1, simulated DO concentrations at OI are similar in pattern, but with less differences between the 2008 and 2012 boundary conditions. Differences of simulated DO concentrations at OI between the 2008 and 2012 boundary conditions start to take place late August 7, about 42 hours lagging that at Segment 1.

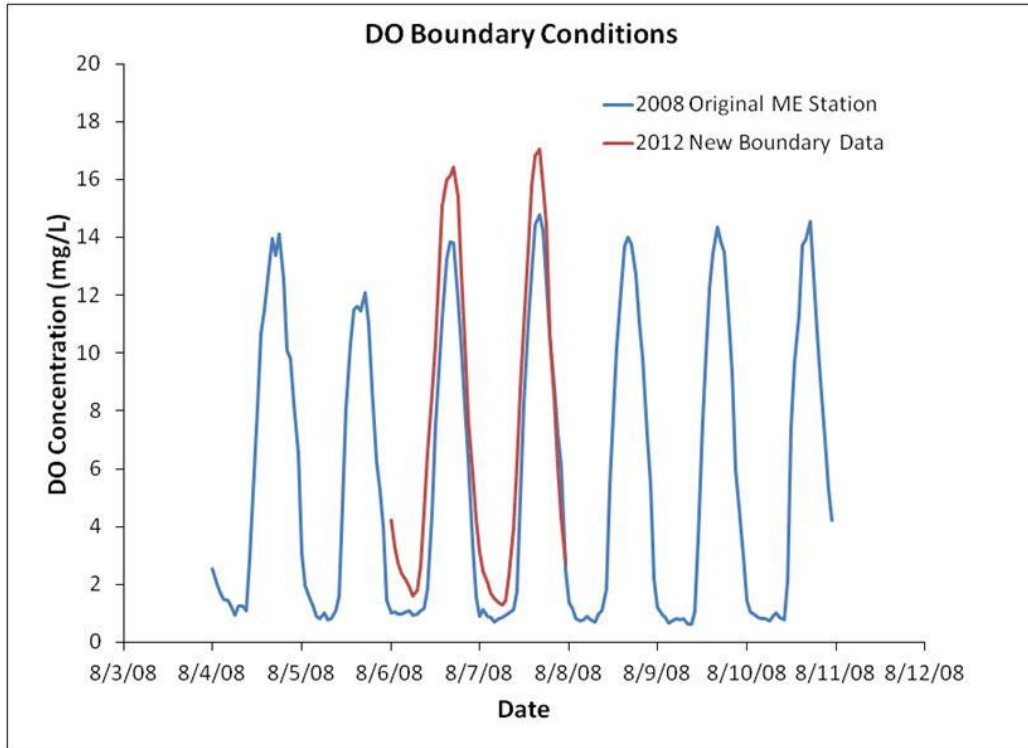


Figure 5.7a. Measured boundary condition for DO during August 6-7 between 2008 and 2012.

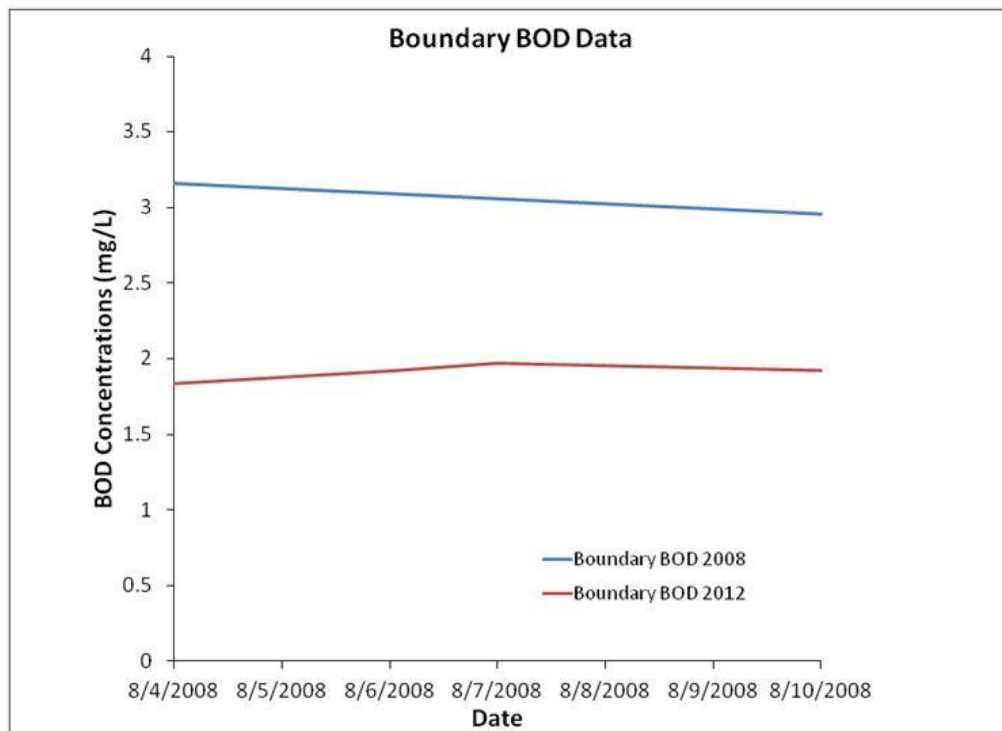
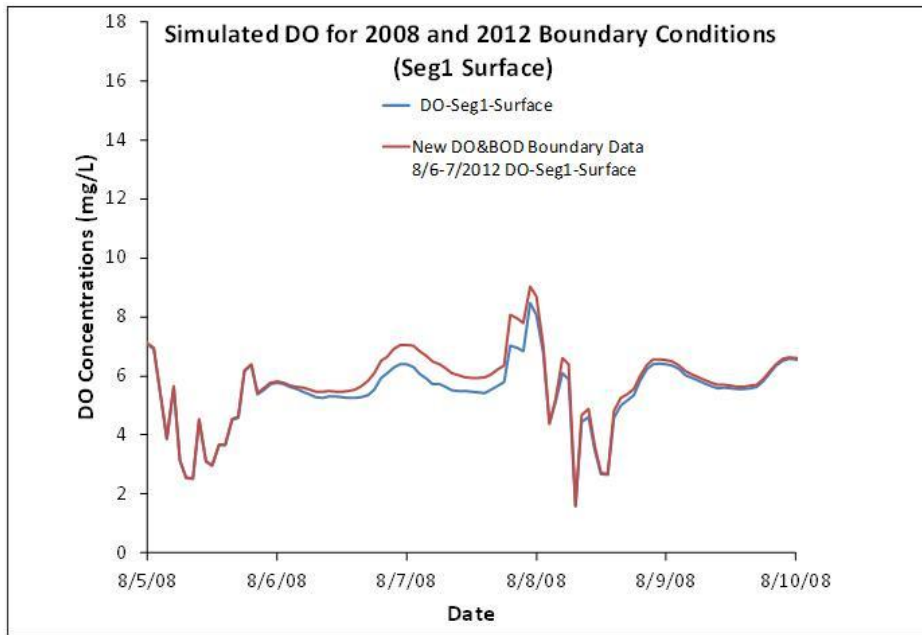
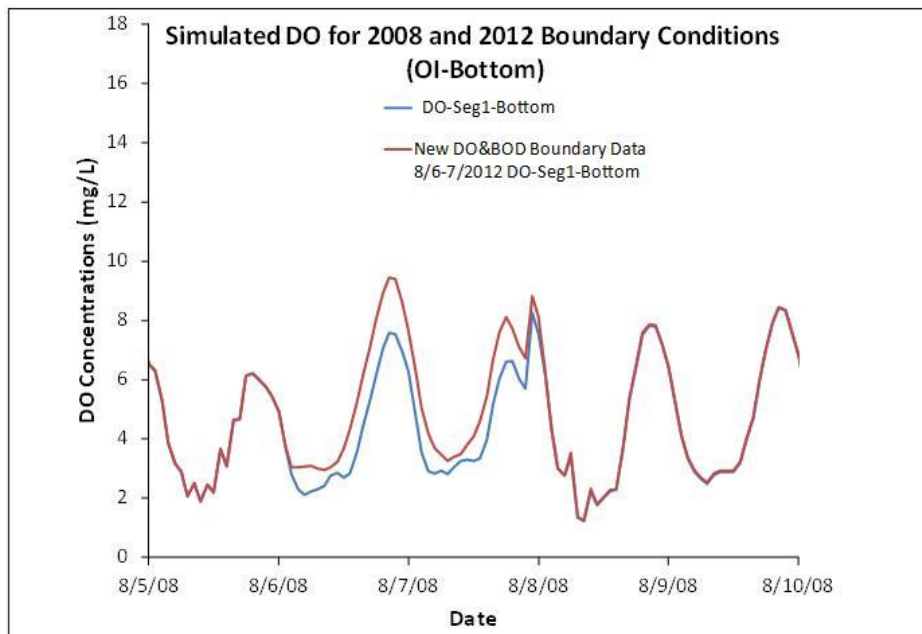


Figure 5.7b. Measured boundary condition for BOD during August 6-7 between 2008 and 2012.



**Figure 5.8a. Simulated DO at surface Segment 1 between the 2008 (blue) and the new 2012 DO data (red) at the boundary.**



**Figure 5.8b. Simulated DO at bottom Segment 1 (blue) between the 2008 and the new 2012 DO data (red) at the boundary.**

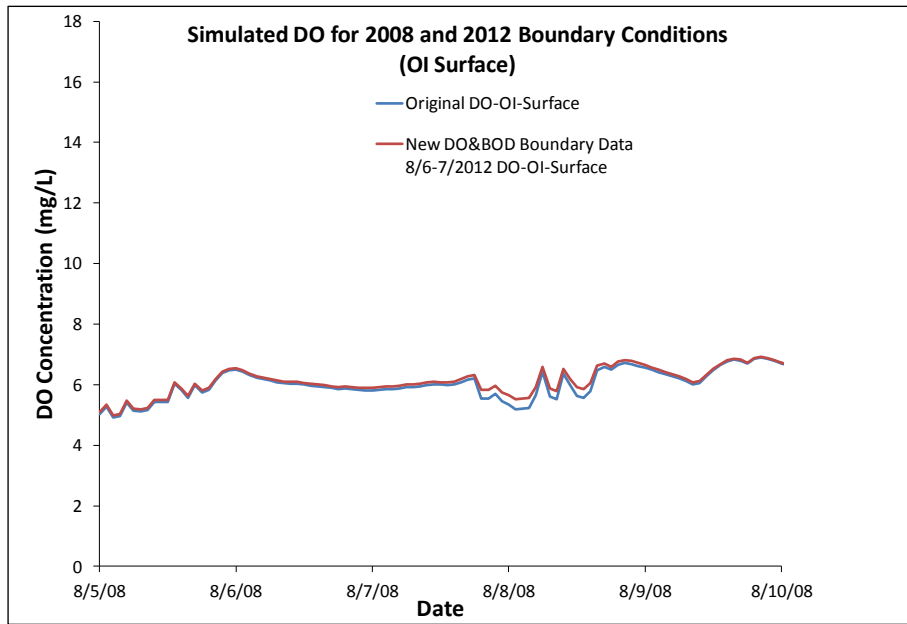


Figure 5.8c. Simulated DO at surface (OI) between the 2008 (red) and the new 2012 DO data (blue) at the boundary.

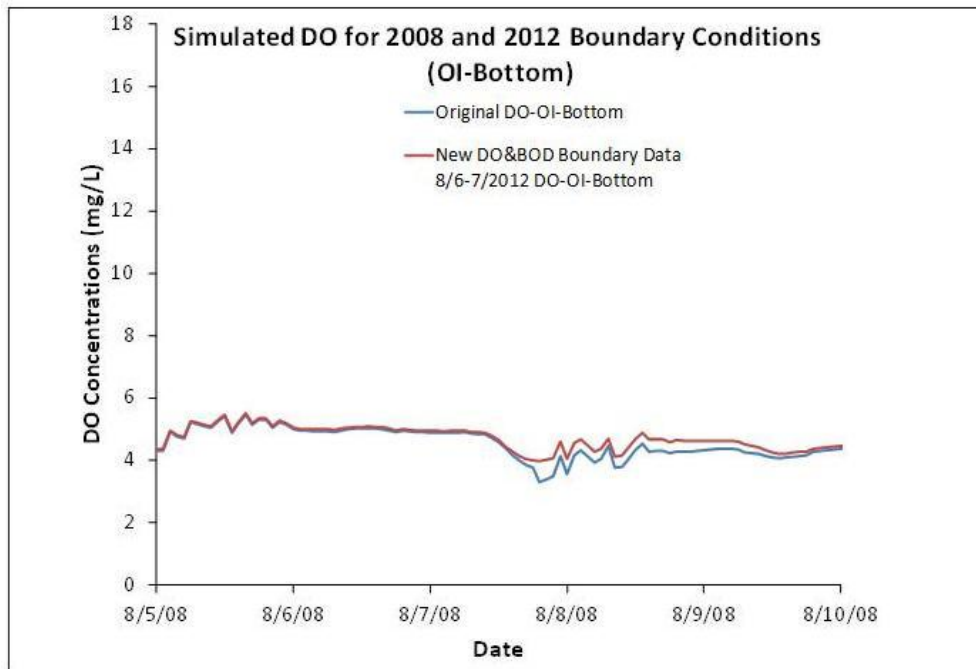


Figure 5.8d. Simulated DO at bottom (OI) between the 2008 (red) and the new 2012 DO data (blue) at the boundary.

### 5.3 Sensitivity Analysis

Dissolved oxygen plays a central role in its relationship with a number of processes, such as re-aeration, primary producer respiration, mineralization, and decaying processes from BOD, SOD, nitrification, etc. Of these processes, we have selected the following key processes for sensitivity analysis to identify and highlight potential processes that govern DO variation in the Slough:

- BOD decay rate
- Macroalgal biomass
- Primary producer respiration
- Mineralization rate
- Creek DO Load
- Creek BOD
- Nutrient load
- SOD

Simulated DO concentrations in the Slough are not sensitive to rates of BOD decay, mineralization or respiration of primary producer when these rates are increased to twice the baseline values (Figure 5.9a). However, changes in simulated DO concentrations and respiration rate are observed when the BOD decay rate increases 10-fold during algal bloom periods (early October 2008; Figure 5.9b).

Macroalgae affects DO in two ways: over-growth resulting in over-saturation from photosynthesis during peak sunlight and anoxia resulting from increased respiration during non-sunlight period. The effects are evaluated by scenarios with and without the existence of macroalgae. Figure 5.10 shows that differences in simulated DO concentrations between the two scenarios are not pronounced, except during the algae blooms period (late October 2008).

Figure 5.11 shows the effect of DO loads from the upstream boundary conditions on in-slough DO concentration. Similar to the 2008/2012 boundary DO data analysis made previously, upstream DO concentrations have some effects on in-slough DO concentrations. However, these effects decrease as slough water is advected downstream, during which DO is gradually governed more by the dynamics of processes shown in Figure 5.1.

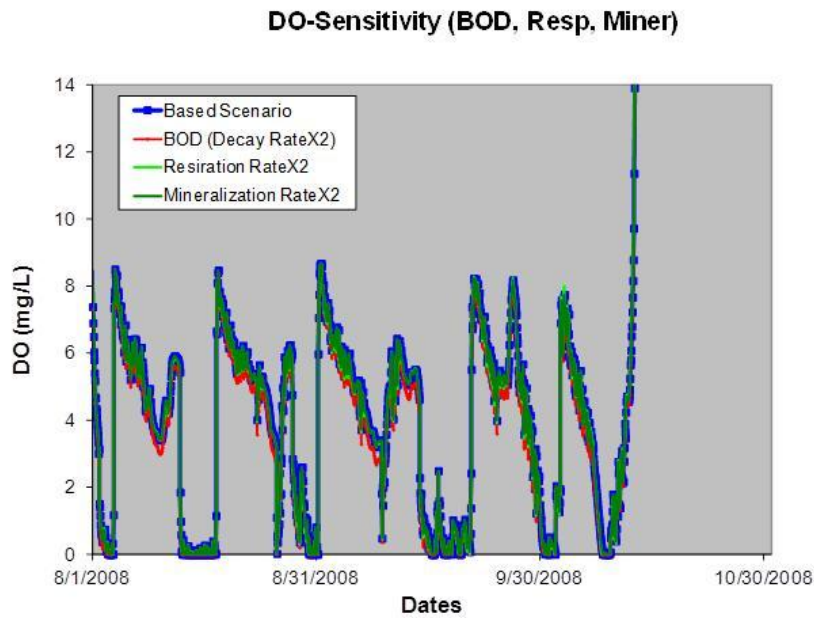
In general, reduction of nutrient loads elevates DO concentrations in the Slough (Figure 5.12). However, increased DO concentration from reduced nutrient loads is not significant for minor or moderate nutrient load reduction.

In the new 2012 boundary data file provided by TetraTech, SOD was analytically projected to have a value of  $-4.5 \text{ g O}_2 \text{ m}^{-2} \text{ d}^{-1}$  SOD. A sensitivity analysis was conducted that used  $-4.5 \text{ g O}_2 \text{ m}^{-2} \text{ d}^{-1}$  SOD for the slough water, compared to  $-1 \text{ g O}_2 \text{ m}^{-2} \text{ d}^{-1}$  SOD for the baseline condition (2008). Simulations were conducted for May 1 to Oct 30, 2008 and results are compared with the baseline conditions (2008; Figures 5.13a-d). Using the  $4.5 \text{ g O}_2 \text{ m}^{-2} \text{ d}^{-1}$  projected by the new boundary data file, simulated DO concentrations at both OI and Segment 1 remained very low ( $0$  to  $2 \text{ mg L}^{-1}$ ) at the bottom layers. Dissolved oxygen concentrations of  $0$  take place more frequently at OI than at Segment 1. These new DO patterns using the  $\text{SOD} = 4.5 \text{ g O}_2 \text{ m}^{-2} \text{ d}^{-1}$  seem to match well with measured values. Note that values measured by McLaughlin et al. (2011) in the Slough were a net positive flux (release of  $\text{O}_2$  to the surface waters) during July and September of  $+1.6$  to  $+3.84 \text{ g O}_2 \text{ m}^{-2} \text{ d}^{-1}$ . Dark chamber fluxes ranged from  $0$  in July to  $-2.84 \text{ g O}_2 \text{ m}^{-2} \text{ d}^{-1}$  in September. They note that the benthic chambers were positioned on a sand

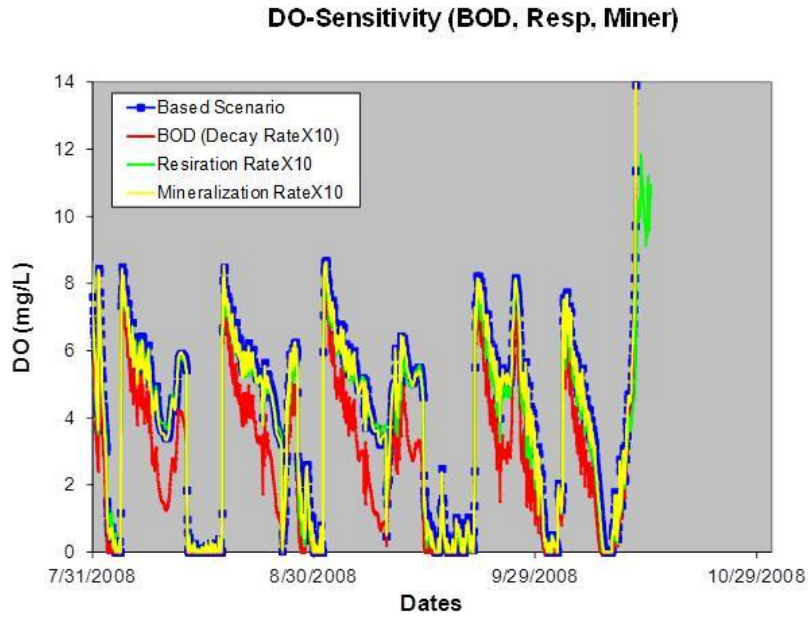


bar “bench”, not at the thalweg of the channel. This bench was higher in the water column and is likely to have a more active microphytobenthos community than the thalweg of the channel. Therefore, there is considerable uncertainty in the true SOD in Loma Alta Slough.

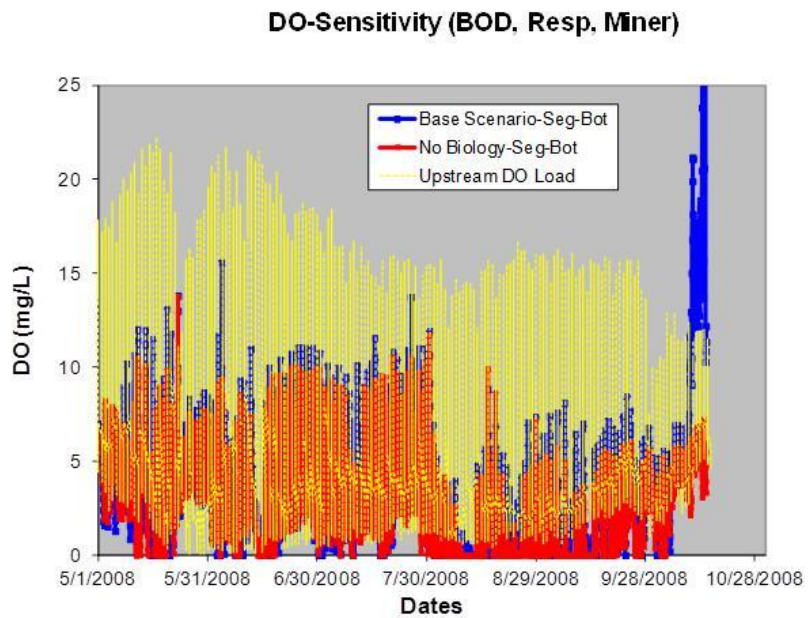
In conclusion, it may be possible that this is the source of the discrepancy between measured and modeled values in 2008. Alternatively, there may be some other within-Slough source of oxygen demand that is driving down bottom water DO. Regardless, based on the new head-of-estuary DO and BOD values, it is clear that the watershed only contributes to the DO fluctuations in the Slough but is not responsible for the chronic hypoxia that was measured in the Slough.



**Figure 5.9a. Sensitivity analysis of DO concentrations for 2X the rates of BOD decay, respiration and mineralization.**



**Figure 5.9b. Sensitivity analysis of DO concentrations for 10X the rates of BOD decay, respiration, and mineralization.**



**Figure 5.10. Sensitivity analysis for DO concentrations with and without macroalgae effects.**

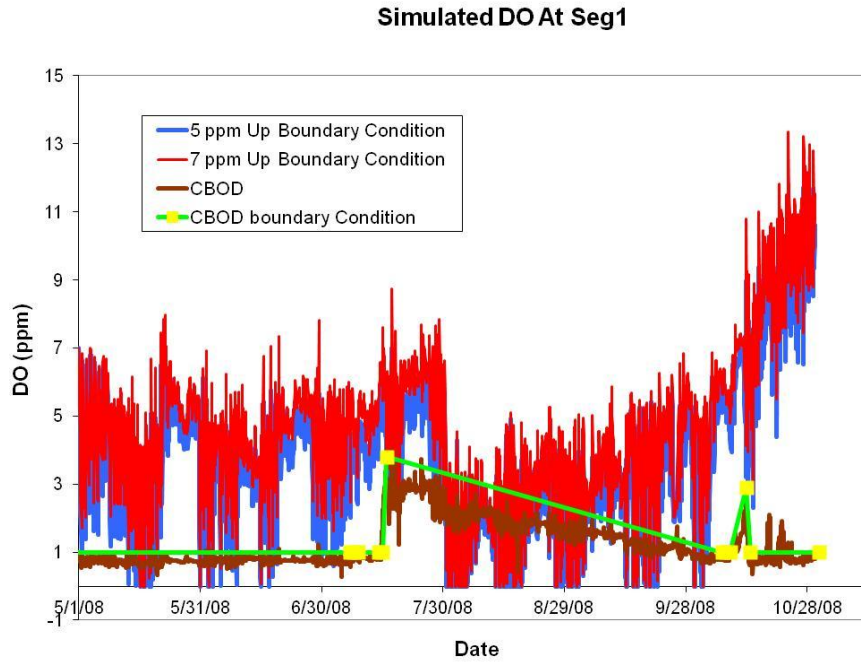


Figure 5.11. Sensitivity analysis for DO concentrations with upstream boundary conditions for DO = 5 mg L<sup>-1</sup> and 7 mg L<sup>-1</sup>.

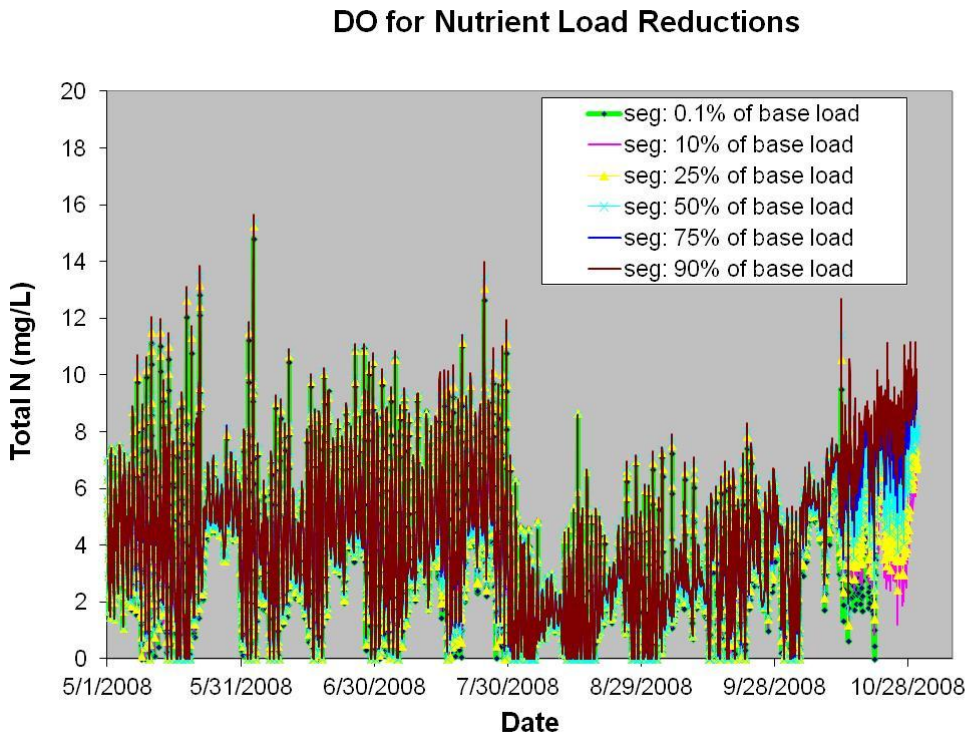


Figure 5.12. Sensitivity analysis for DO reduction of nutrient loads.

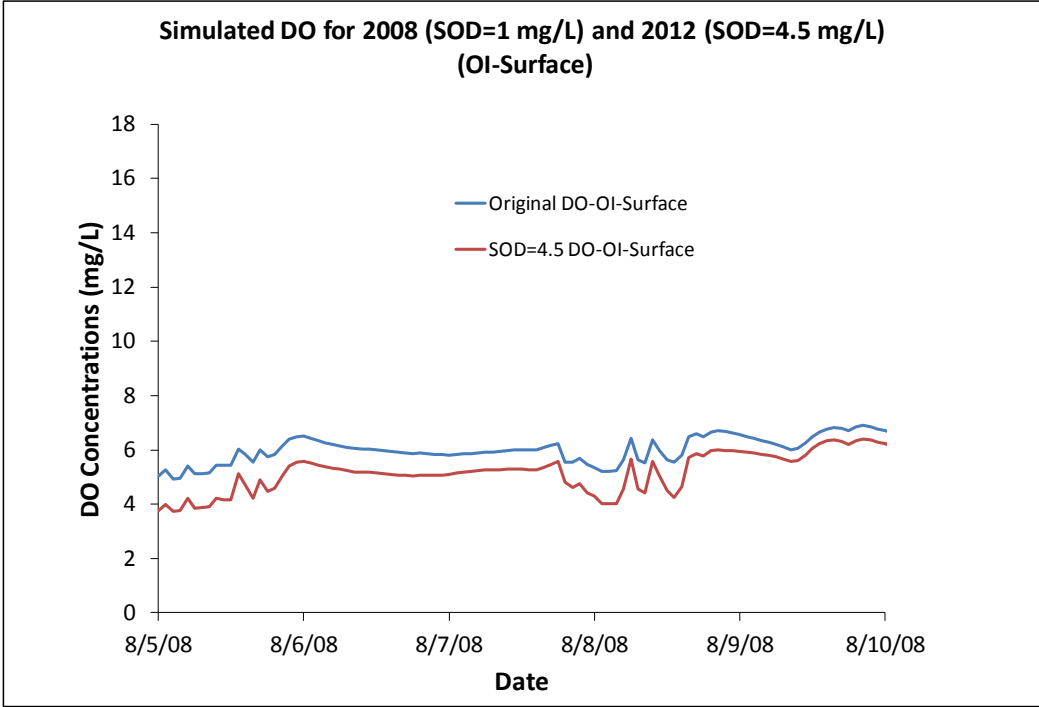


Figure 5.13a. Sensitivity analysis for DO at OI surface 2008 and 2012.

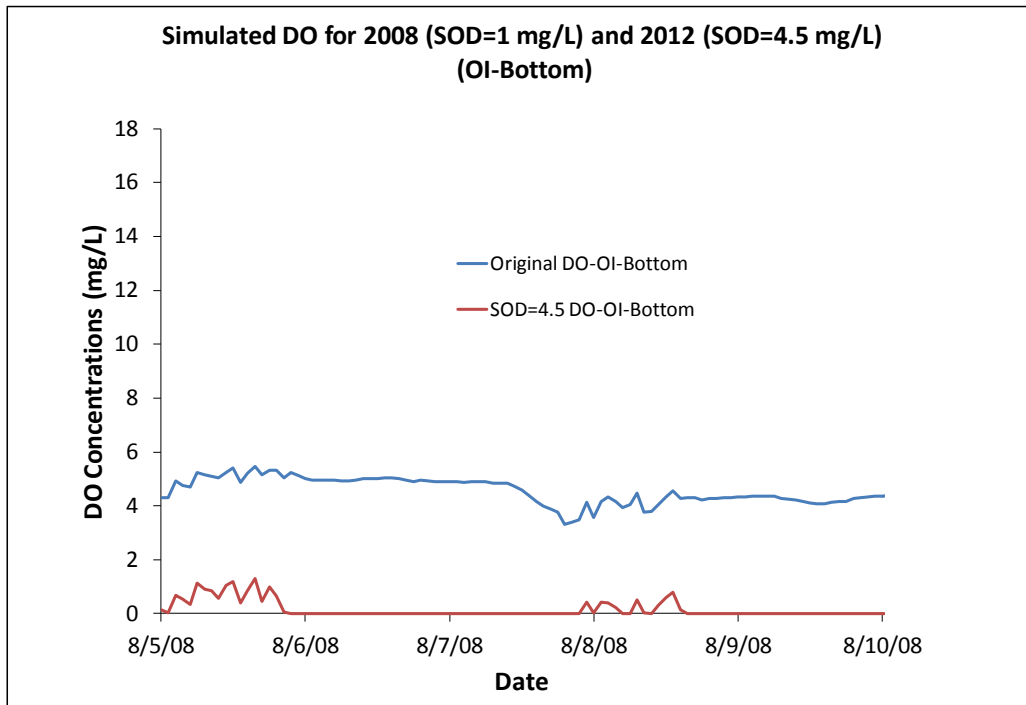


Figure 5.13b. Sensitivity analysis for DO at OI bottom 2008 and 2012.

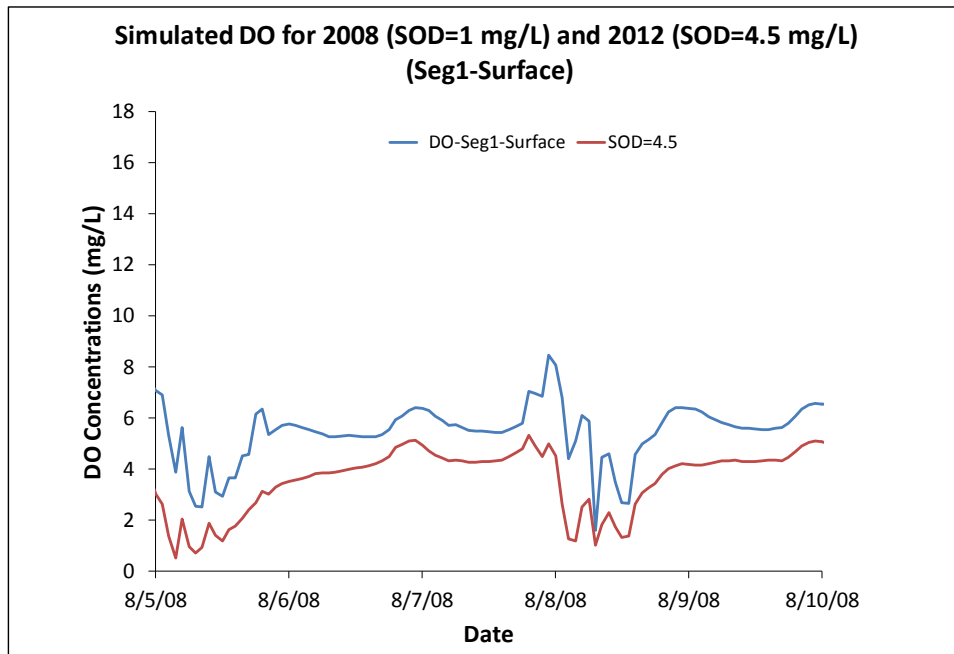


Figure 5.13c. Sensitivity analysis for DO at Segment 1 surface 2008 and 2012.

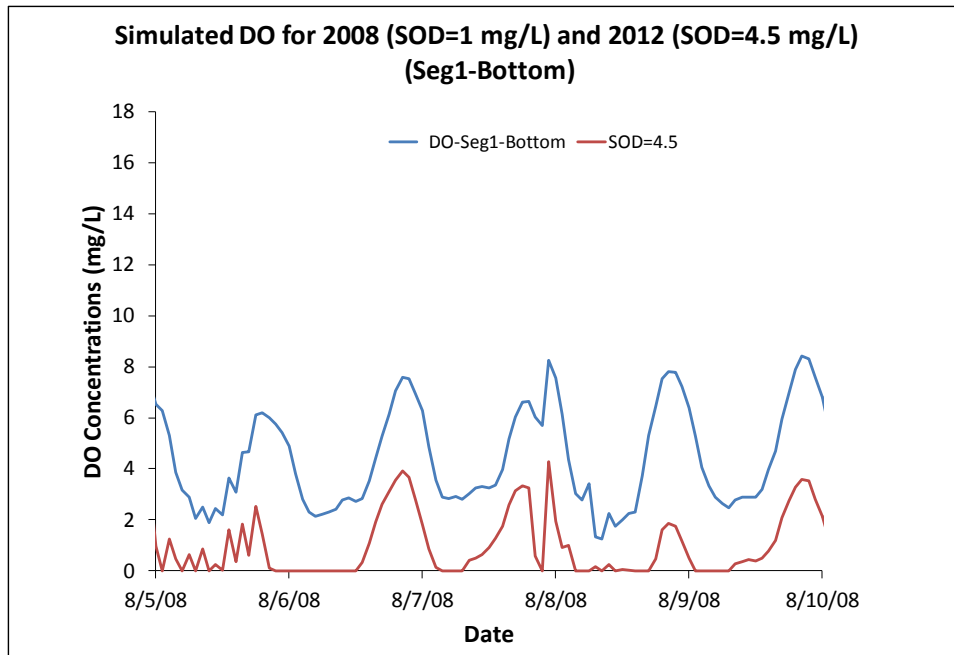


Figure 5.13d. Sensitivity analysis for DO at Segment 1 bottom 2008 and 2012.

### 5.3.1 Calibration and Sensitivity Analysis for Macroalgae

#### Calibration

The advance eutrophication module of WASP simulates three species of microalgae, including periphyton. Macroalgae is not directly simulated in WASP, because it is assumed that macroalgae has a life cycle similar to that of microalgae. However, macroalgae in Loma Alta Slough were observed to be stationary (immobile) most of the time, unlike microalgae which is transported by ambient water. Therefore, the advective and dispersive processes associated with microalgae were turned off to mimic the immobility of macroalgae.

Based on spatially averaged field and modeled biomass, the model shows good accuracy (estimated 3% error) and fit ( $R^2 = 0.63$ ). Figure 5.14 shows simulated macroalgae concentrations ( $\text{g-C m}^{-2}$ ) at OI. Since algae simulated by WASP are in the unit of  $\mu\text{g chlorophyll-a/L}$ , a unit conversion was performed in order to compare with measured values in  $\text{g-C m}^{-2}$ . Two carbon to chlorophyll-a ratios, namely 30 and 120, were used, both of which are within the literature-reported values; 30:1 showed the best fit and was used for further simulations. Figure 5.15 shows simulated macroalgae biomass at OI during the 2008. Macroalgae biomass concentration was low before May when the inlet was open and exchange of the freshwater flows and the ocean water kept the slough adequately flushed with low macroalgae biomass. When the inlet is closed from May to end of October, relatively abundant nutrient accumulation increased macroalgae to growth. .

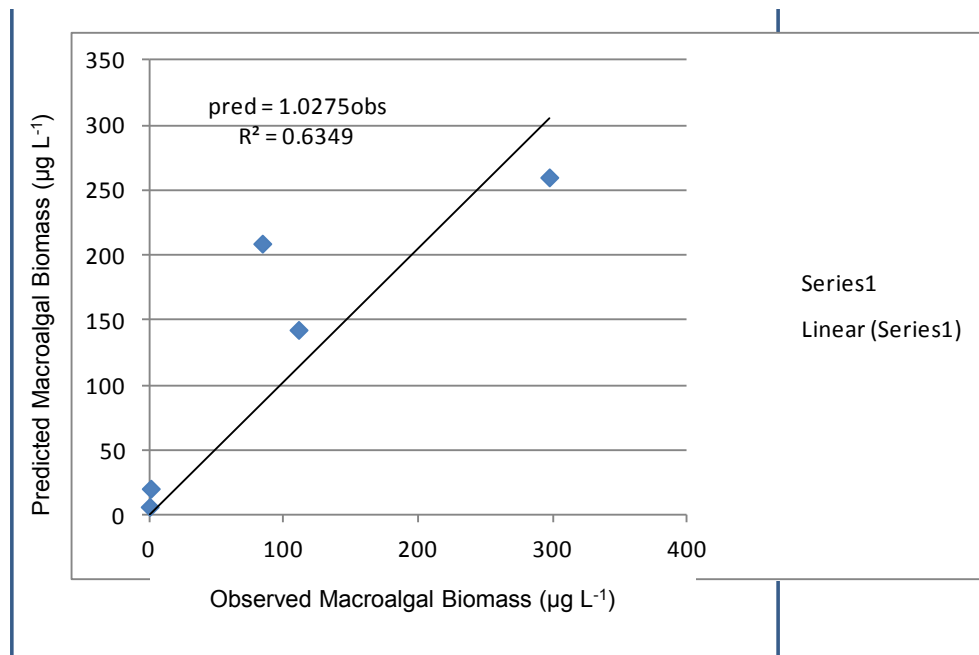


Figure 5.14. Comparison between predicted and measured macroalgal biomass at OI.

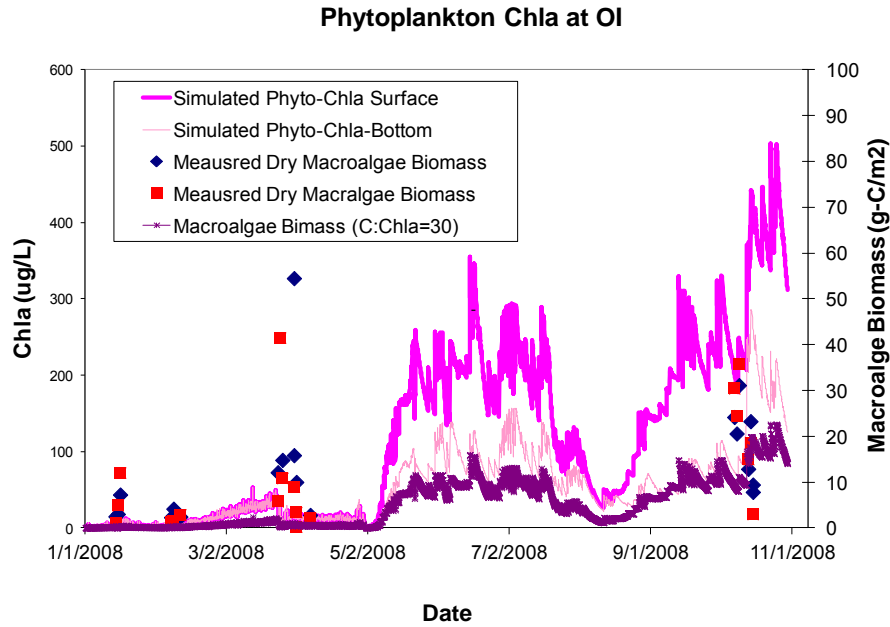


Figure 5.15. Predicted and measured macroalge concentrations during 2008.

Sensitivity Analysis

Key parameters governing macroalge biomass in the Slough include biomass growth rate and death rate. The following parameters supplied by SCCWRP were used in the base model runs (Table 5.4). For the base scenario (Scenario #1), macroalge growth rate and death rate were 1.8 and 0.01 day<sup>-1</sup>, respectively. Death rate increased 10-fold to 0.1 day<sup>-1</sup> for Scenario #2 and growth rate increased to 2.3 day<sup>-1</sup> for Scenario #3.

Table 5.4. Growth and death rates for macroalge biomass sensitivity analysis simulations.

	Base Value day <sup>-1</sup> (Scenario #1)	Scenario #2 (day <sup>-1</sup> )	Scenario #3 (day <sup>-1</sup> )
Growth Rate	1.8	1.8	2.3
Death Rate	0.01	0.1	0.01

In WASP, growth of macroalge is defined as:

$$G = G_{Max} L_L L_N L_P$$

where G-Max is the growth rate specified in Table 1, LL, LN, LP, are growth limitation factors by the available light, in-organic nitrogen and phosphorus, respectively. Figure 16 shows the time series of the



three growth limitation factors. In general, the growth is limited by light, and phosphorus for most of the May-Oct 2008 period. Nitrogen has its limitation on growth only during mid-July to mid-August.

Sensitivity analysis was conducted to evaluate effects of growth and death rates on macroalgae biomass. Due to the current structure of WASP, a full scale of sensitivity analysis is difficult to conduct. We used and defined the base values of growth rate and death rate as Scenario #1. For Scenario #2, the death rate was increased from the base value of  $0.01 \text{ day}^{-1}$  by 10-fold to  $0.1 \text{ day}^{-1}$ . For Scenario #3, the growth rate was increased from the base value of  $1.8 \text{ day}^{-1}$  to  $2.3 \text{ day}^{-1}$ , while the death rate remains at the base value of  $0.01 \text{ day}^{-1}$ .

Figure 5.16 shows results of simulated macroalgae biomass concentrations for the three scenarios. In general, predicted macroalgae biomass maintains highest magnitude for Scenario #3 (highest growth rate), followed by Scenario #1 (base values), and Scenario #2 with higher death rate produced lowest biomass in the slough water. Algal growth rate is the most important parameter that directly governs biomass concentration. A 30% increase of the growth rate (from 1.8 to  $2.3 \text{ day}^{-1}$  for Scenario #1 to #3) resulted in increase of biomass concentration about 2-fold. This drastic increase from 30 to 200% in the growth rate of biomass reflects the first-order characteristics of macroalgae growth. An increase in death rate resulted in reduced biomass concentrations. However, compared to growth rate, death rate has a secondary impact on biomass concentration; a 10-fold increase in the death rate (from 0.01 to  $1 \text{ day}^{-1}$  for Scenarios #1 and #2) resulted in an approximate 2-fold decrease in biomass concentration.

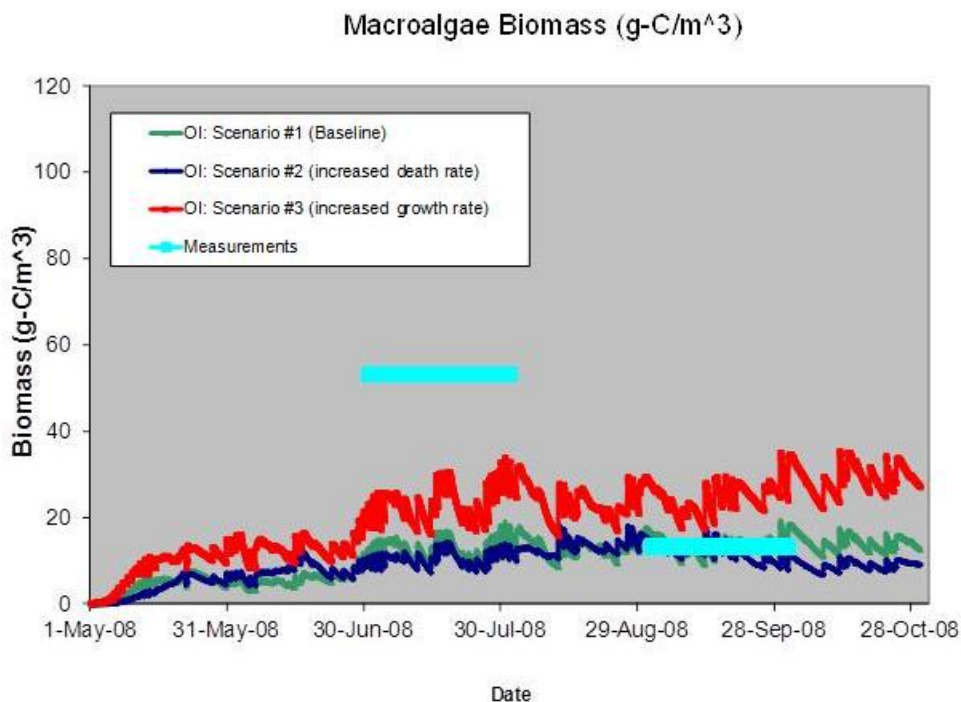
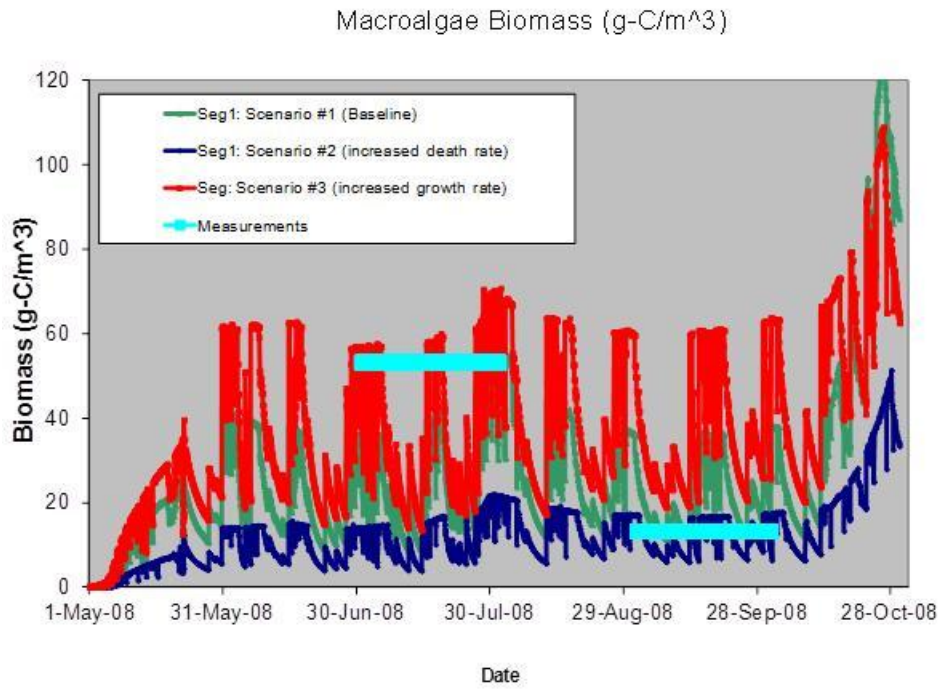
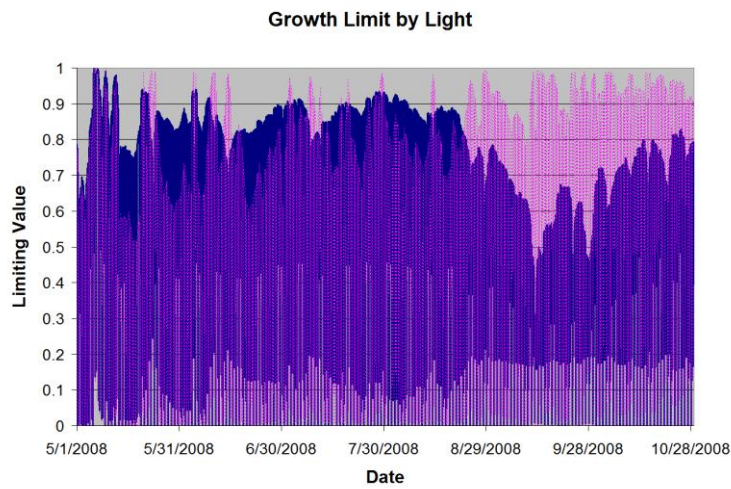
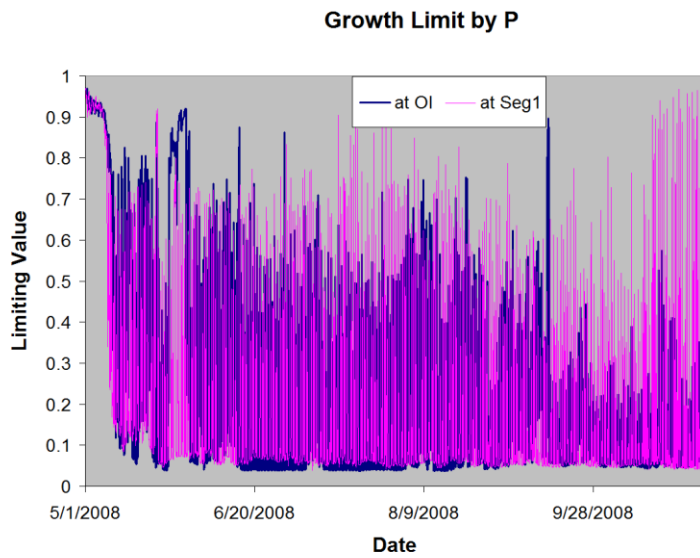
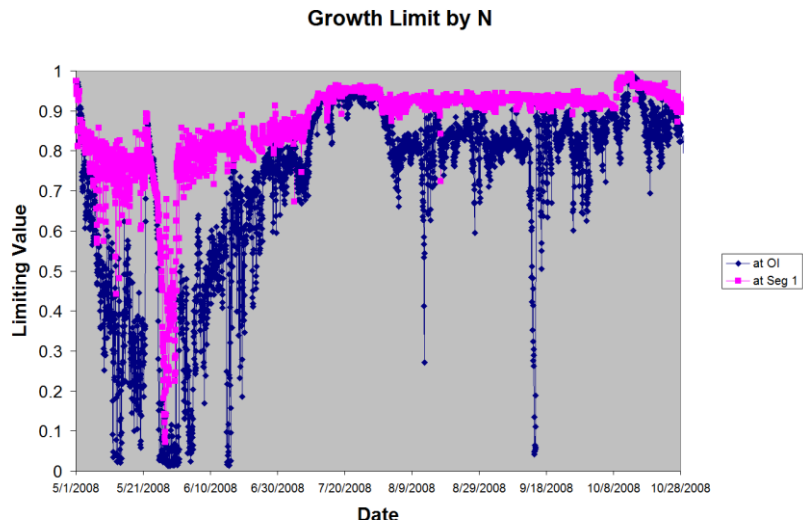


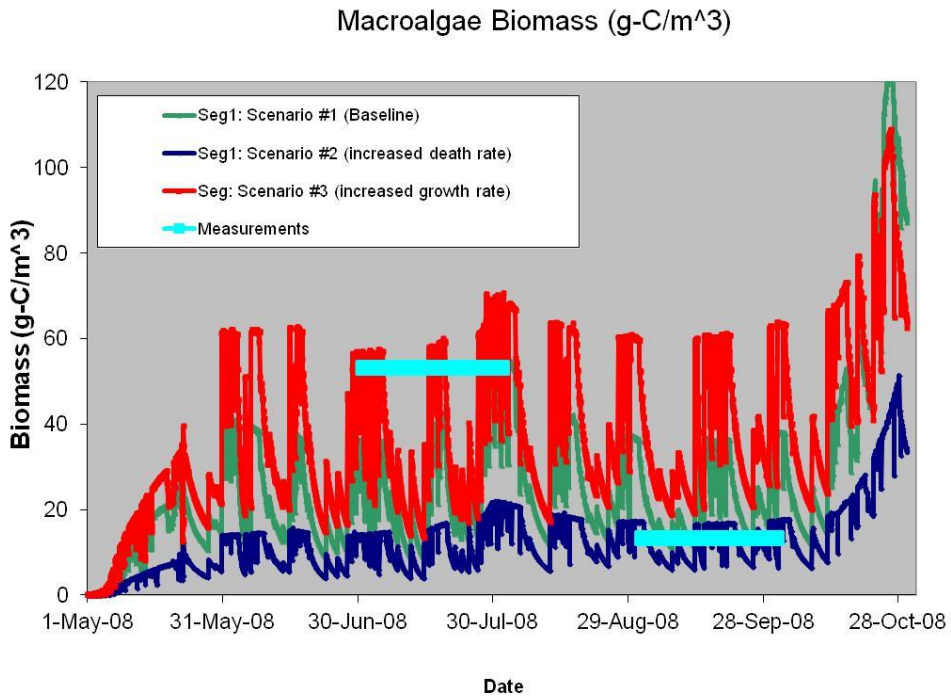
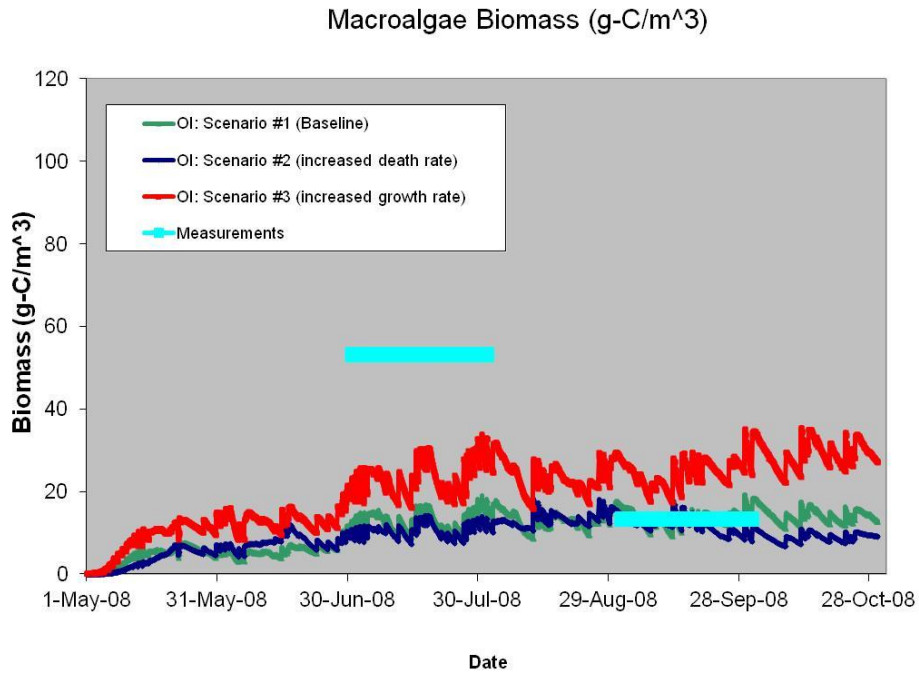
Figure 5.16a. Simulated results of baseline condition, increased growth rate and increased death rate on macroalgae biomass at OI.



**Figure 5.16b. Simulated results of baseline condition, increased growth rate and increased death rate on macroalgae biomass at Segment 1.**

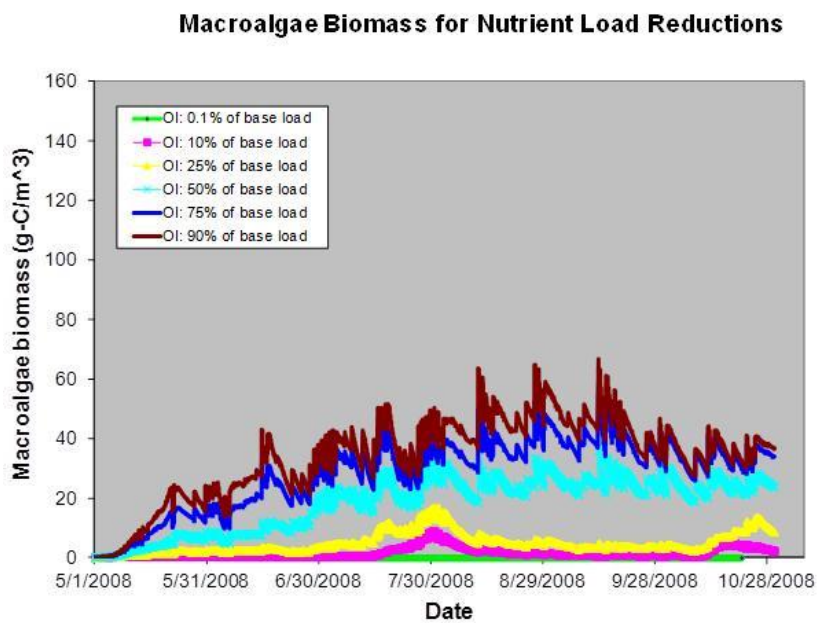


**Figure 5.17. Time series of growth limitation functions for nitrogen, phosphorus and light.**

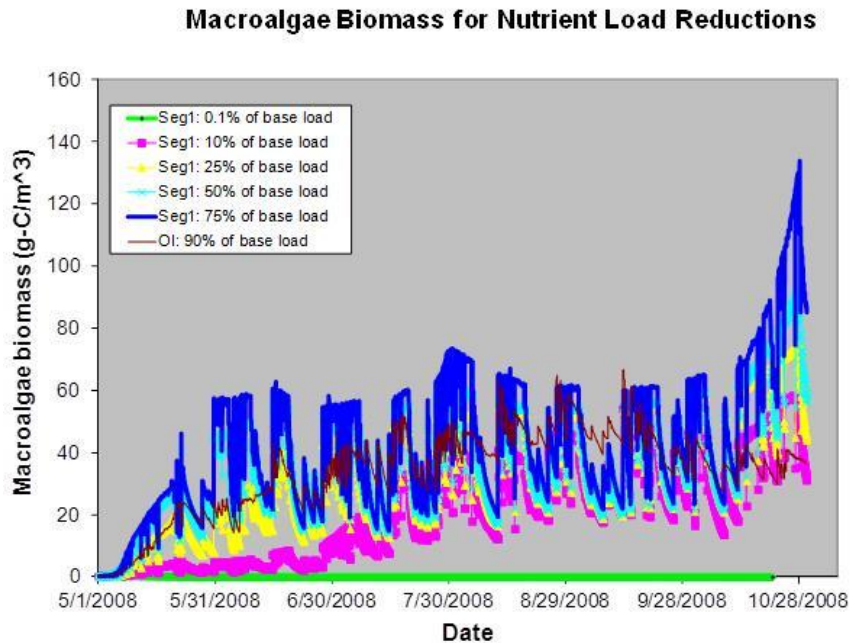


**Figure 5.18. Simulated macroalgae concentrations for the three scenarios defined in Table 5.2 (measurements were taken during July and September 2008).**

Sensitivity analysis was conducted between macroalgae biomass and nutrient load reduction. Figures 5.19a and 5.19b show simulated macroalgae biomass for 6 reduced nutrient loads ranging from 0.1, 10, 25, 50, 75, and 90% of the base loads. Macroalgae biomass decreases with reduced load, and vice versa. However, biomass is not linearly proportional to nutrient load. There are multiple reasons why linearity does not hold. The primary reason is that dependence of macroalgae growth on nutrient is a nonlinear relationship. Furthermore, the threshold nutrient concentrations play another important role in determining at what concentrations, do nutrients become limiting. Another possible reason is related to the first-order characteristics of macroalgae growth, which has in-direct influence on the relationship between macroalgae biomass and nutrient loads.



**Figure 5.19a. Macroalgae biomass at OI for nutrient load reduction scenarios.**



**Figure 5.19b. Macroalgae biomass at OI for nutrient load reduction scenarios.**

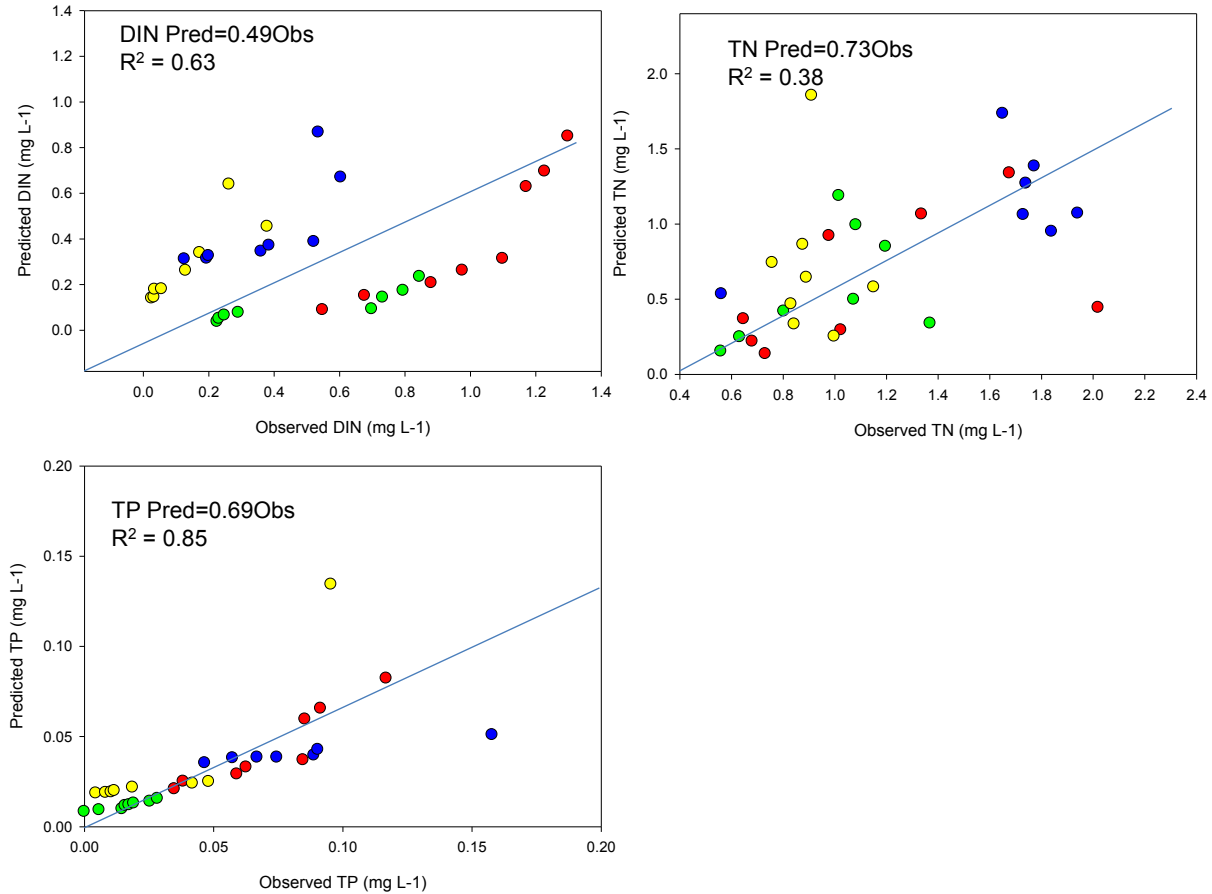
In summary, simulation of macroalgae biomass in the dynamic Loma Alta Slough was challenging because of existing data gaps for the growth cycle of macroalgae and no current model to simulate rafting macroalgae. With the released EPA’s most recent water quality model, WASP, we eliminated advection and dispersion processes and used the same growth/death cycle for microalgae to simulate macroalgae biomass.

In general, model-simulated macroalgae biomass resembled that of measurements both in concentration magnitude and trend. Differences between modeled and measured biomass concentrations were generally within 3% for spatially averaged data. Sensitivity analysis also shows that a number of key model parameters govern macroalgae biomass. First, macroalgae growth rate plays a predominant role in governing macroalgae biomass, and death rate plays only a secondary role. Nutrient loads also directly impact biomass. However, the relationship between nutrient load and algal growth is not linear, which is further complicated by the nutrient-limiting factor.

### 5.3.2 Calibration and Validation of Slough Nutrient Concentrations

Nutrient loads enter the study domain from the upstream boundary (ME Station) as the boundary conditions are identified by four different forms: ammonia-N, nitrate-N, ortho-phosphorous-P, organic N and organic P. Once entering the slough, these nutrient loads interact with macroalgae dynamics and dissolved oxygen dynamics (Figure 5.1). Nutrient data were measured only during the periods of Oct 7-9 and 13-15 for the OI station (Figure 5.20), and during the periods of Jul 7-9, 14-16 and the periods of Oct 7-9 and 13-15 for Segment 1 (Figure 5.21).

Figures 5.20-5.22 show that all model results are in the same ranges as the measured values for all the three nutrient indicators, though the model is generally under-predicting nutrient concentrations by roughly 30% for TN and TP and 50% for DIN. Total phosphorus concentrations were less than those of total nitrogen concentrations by an order of magnitude. Both simulated and measured total-P and total-N do not include contributions from macroalgal N and P.



**Figure 5.20. Comparison of observed versus predicted DIN (ammonium + NO<sub>x</sub>; top left panel), total N (top right panel) and total P (bottom left). Predicted = X Observed is the linear regression model of observed versus predicted, no intercept, where X is the model slope. R<sup>2</sup> represents model fit. Color of dot represent sampling period, where blue = January, yellow = April, green= July and red = October 2008.**

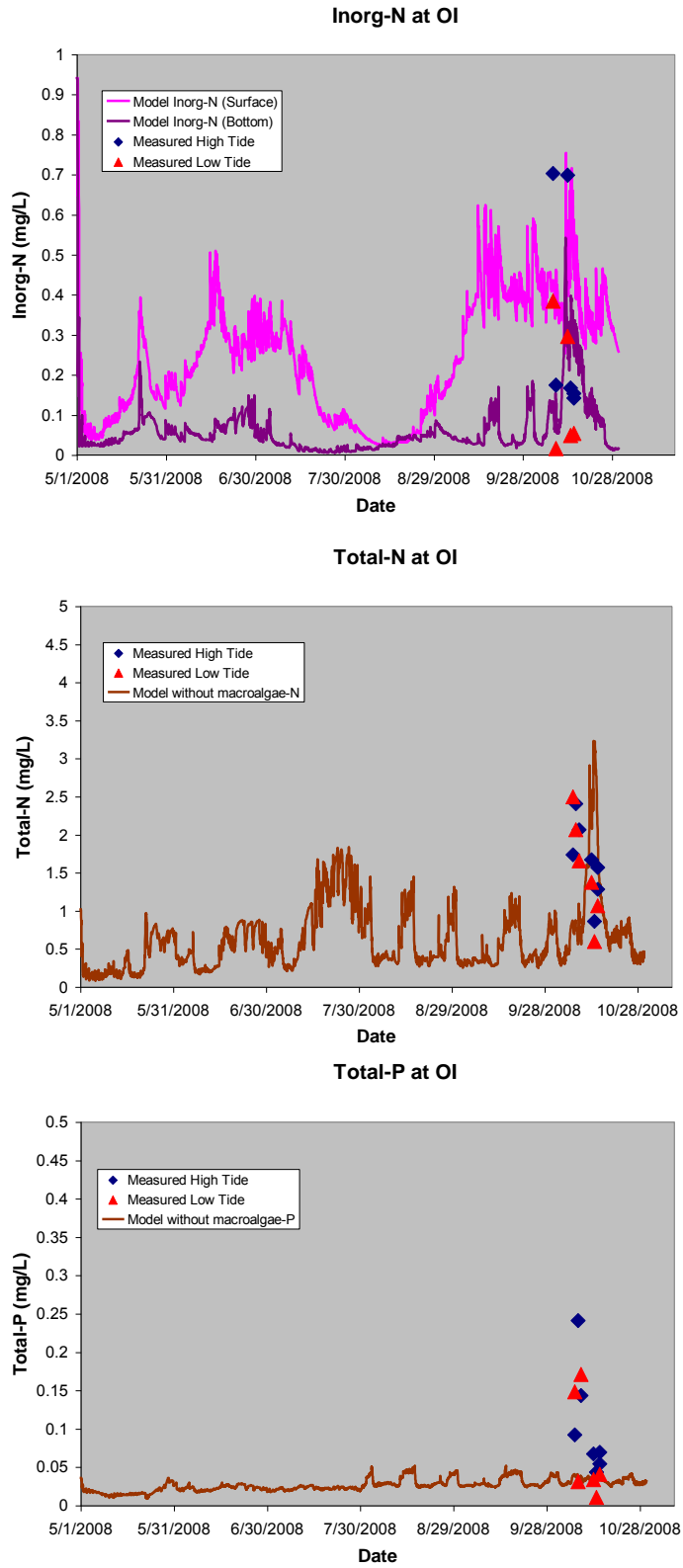


Figure 5.21. Simulated and measured total inorganic-N (above), total-N (middle) and total-P (bottom) at OI station.



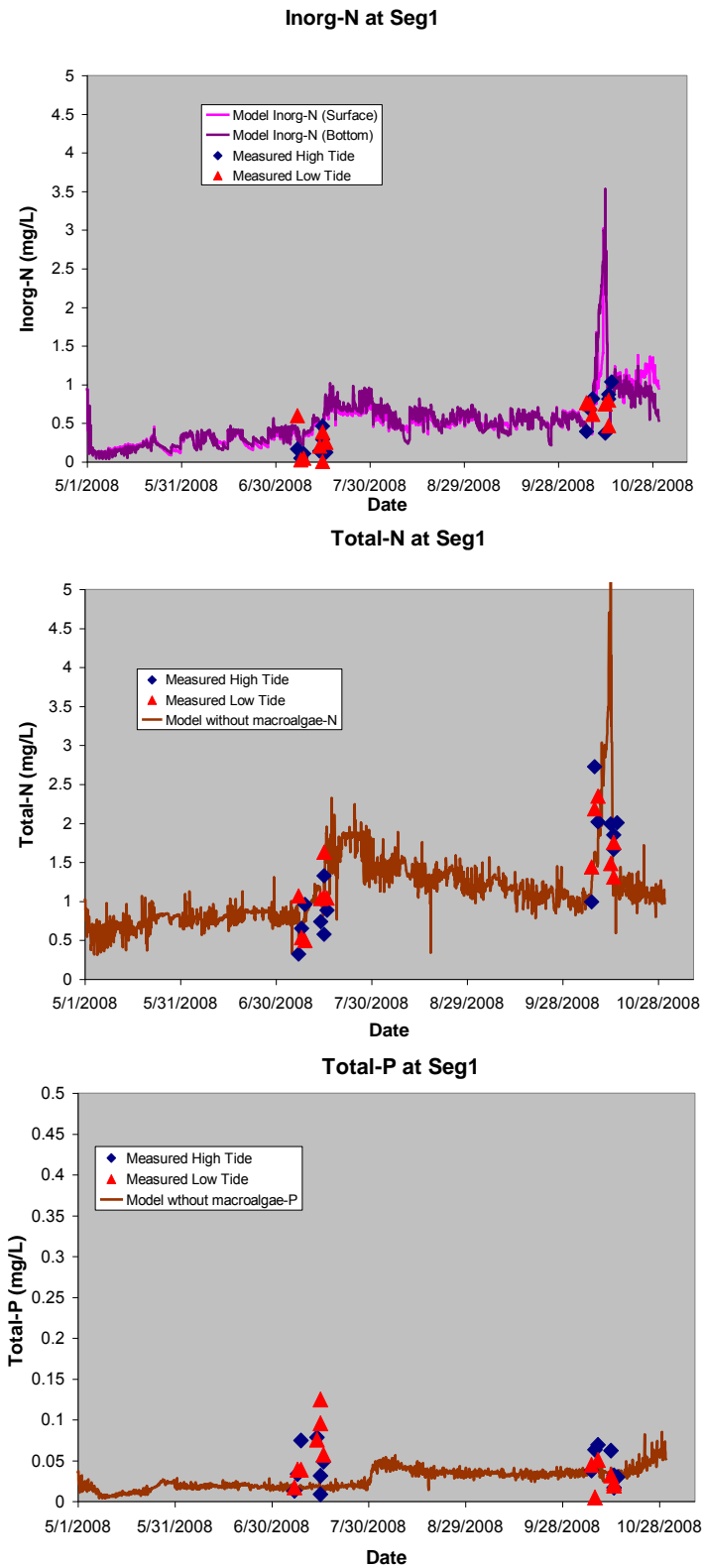


Figure 5.22. Simulated and measured total inorganic-N (above), total-N (middle) and total-P (bottom) at OI station.

## 5.4 Uncertainties in Eutrophication Modeling

### 5.4.1 Dissolved Oxygen

Based on the sensitivity analysis conducted above, DO is most sensitive to SOD. This is not only reflected directly from the model run scenario where simulated DO is inversely related to the SOD prescribed. Simulated DO in the slough seem to always exhibit diurnal fluctuation, whereas measured DO exhibits both a diurnal cycle and an extended period of very low (close to zero) DO concentration. Effects on DO concentration related to the upstream boundary condition are decreased in the downstream Slough. Dissolved oxygen concentrations in the Slough seem to be less sensitive to all the other processes, with only respiration rates become relatively important during the algal bloom periods. It is noted that DO concentrations are not very sensitive to external nutrient loads, which suggests that DO concentrations are buffered from direct nutrient loading.

### 5.4.2 Macroalgae

Macroalgae biomass in the Slough is directly governed by growth and death rates. These two rates seem to dictate macroalgae biomass in a non-linear fashion, which is further complicated by the nutrient limiting process. Comparatively, macroalgae growth is most limited by phosphorus, least by nitrogen (except during the late May of 2008 when nitrogen is at its low values), and moderately by light following the diurnal cycle. Therefore, when nutrient concentrations are close to the threshold values, macroalgae biomass is sensitive to the external nutrient loads.

### 5.4.3 Nutrient Concentrations

Nutrient concentrations in the Slough are directly linked to nutrient loads from the upstream boundary. Based on the weak diurnal variations, uptake of nutrients by macroalgae and/or mineralization from dead algae does not constitute an important sink/source for in-slough nutrients.

## 5.5 Summary of Eutrophication Modeling

Eutrophication for Loma Alta Slough was studied by the use of the linked EFDC+WASP model. While we were able to simulate the entire year of Nov 2007-Oct 2008, model results were presented and analyzed only for May-Oct 2008 when the inlet was closed and the water was most eutrophic. This was identified by the Regional Board and stakeholders as the critical condition.

Overall, the model performed well for simulation of macroalgae and nutrient concentrations. Macroalgae simulations had high accuracy (+/- 3%), while nutrient concentrations were underpredicted by 30%. Model results show that macroalgae growth during the period was limited by light throughout the simulation period, followed by limitation of phosphorus. Availability of inorganic nitrogen produced least limitation on growth. Similar to the growth rate, death rate is also a key parameter in governing macroalgae biomass in the Slough. Simulated macroalgae concentrations and measured values (only two data) are of the same order of magnitude.

Dissolved oxygen, which is believed to be the key indicator of eutrophic condition, was simulated and compared with measurements. Simulated DO and measured DO near the bottom were compared for both OI and Segment 1 for most of the May-Oct 2008 period. During Jul-Sep, 2008, the model did not capture the mean nor the diurnal variability of measured bottom water data. Modeled DO concentrations were persistently higher than measured values.

Additional data on DO and BOD loading were collected at the headwaters of the Slough during 2012 to discern whether the chronic hypoxia in the Slough was due to the higher BOD load and lower DO at the headwaters versus the mass emission station. Comparison of measured 2008 at the MES versus 2012 data at the head of the estuary illustrates that the DO loading between these stations was comparable and the BOD was actually lower at the headwaters.

Additional sensitivity analysis conducted on SOD illustrated that chronic hypoxia could be simulated with very high SOD ( $4.5 \text{ g m}^{-2} \text{ d}^{-1}$ ) in Loma Alta Slough. These rates do not compare with measured values in the Slough, although McLaughlin et al. (2011) note that there is considerable uncertainty in the measured values.

In conclusion, it may be possible that SOD this is the source of the discrepancy between measured and modeled values in 2008. Alternatively, there may be some other within-Slough source of oxygen demand that is driving down bottom water DO. Regardless, based on the new head-of-estuary DO and BOD values, it is clear that the watershed only contributes to the daily DO fluctuations in the Slough but is not responsible for the chronic hypoxia that was measured in the Slough.

## 6 MODEL APPLICATION

The purpose of this section is to describe how the watershed loading and Slough hydrodynamic and water quality models were used to support decision-making on the nutrient and bacteria TMDL. The model was used in four types of applications:

- Calculation of numeric targets
- Calculation of total maximum daily loads
- Calculation of land-used based sources of bacteria and nutrients
- Analysis of implementation scenarios to meet TMDL numeric targets

### 6.1 Use of Models to Calculate Numeric Targets

The estuary hydrodynamic and water quality models were used to support decision-making on numeric targets for bacteria and eutrophication. A summary of discussions and relevant background material are presented below.

#### 6.1.1 Bacteria

##### Basin Plan Objectives

The SDRWQCB has established numeric targets for fecal indicator bacteria in the Bacteria I TMDL. The Basin Plan allows a 22% exceedance frequency of these objectives for wet weather and 0% exceedance for dry weather (SWRCB Basin Plan).

**Table 6.1. Numeric targets used for model scenario study. Targets are given in #/100 ml**

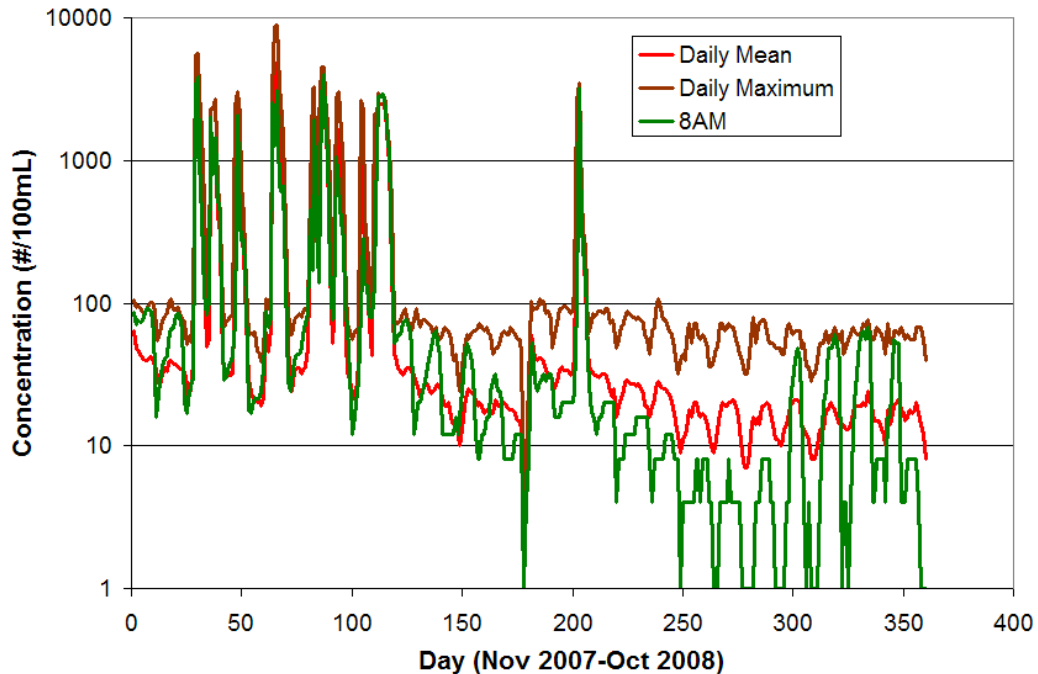
<b>Numeric Targets</b>	<b>Enterococci</b>	<b>Fecal Coliform</b>	<b>Total Coliform</b>
Single Sample (Daily Data)	104	400	10,000
Geomean 30-day running	35	200	1000

##### Calculation of Bacteria Numeric Targets

At the May 12, 2011 stakeholder meeting, the stakeholders, the SDRWQCB, and EPA Region 9 staff discussed temporal and spatial aggregation of data. Three options for temporal aggregation of data were discussed: 1) daily maximum, 2) daily average and 3) 8 a.m. sample for both single sample exceedance and 30-day geomean. Two options for spatial averaging were discussed (Slough average, Slough maximum). Stakeholders and regulatory staff achieved consensus on how to use model output to calculate compliance with numeric targets, given below. Stakeholders and the regulatory staff agreed this approach was “balanced” (neither overly conservative or liberal).

1. Simulated concentrations need to be spatially averaged between the sand berm (Ocean Inlet Station) and the railroad bridge. The time series of the simulated concentrations will be based on the daily mean (Figure 6.1).

2. A 30-day geo-mean running window needs to be imposed on the time series. Both the geo-means and single sample concentrations will be compared with the corresponding criteria for each of the three bacteria
3. Days of exceedance will be used for comparison between simulated bacteria concentrations and the criteria over a one-year period.
4. Exceedance days will be imposed for wet weather (defined as a rain event greater than 0.1" for the day of the storm plus 72 hours).



**Figure 6.1. Examples of three options for temporal aggregation of FIB data: daily mean, daily maximum an 8 a.m. options.**

Subsequent to the meeting, the stakeholders also proposed to regulatory staff that the definition of wet weather be consistent with the reference study (0.1" or greater) rather than what the Department of Public Health uses (0.2", City of Oceanside 2003). The regulatory staff accepted this definition.

The number of days in which the Slough exceeds the basin plan objectives was then compared with those allowed by application of the beach bacteria reference study, which allows a 22% exceedance frequency for wet weather and 0% exceedance for dry weather, SWRCB Basin Plan XXXX).

Stakeholders discussed the need for an estuary reference study with the regulatory staff and it was agreed that this could be proposed as a special study for reopening the TMDL, once it had been promulgated.

### 6.1.2 Eutrophication

**Eutrophication** is defined as the acceleration of the delivery and/or *in situ* production and accumulation of organic matter in a waterbody (Nixon 1995), typically from the overgrowth of algae and aquatic plants. While some waterbodies may have the tendency to accumulate organic matter over time, “eutrophication” signals the acceleration in this process. Eutrophication results in a wide range of effects including harmful algal blooms, hypoxia, and impacts on aquatic food webs. One of the main causes of eutrophication in estuaries is nutrient over-enrichment (nitrogen, phosphorus and silica). However, other factors influence primary producer growth and the build-up of nutrient concentrations, and hence modify (or buffer) the response of a system to increased nutrient loads (hereto referred to as **co-factors**). These **co-factors** include hydrologic residence times, mixing characteristics, water temperature, light climate, grazing pressure, etc.

*Existing SD Regional Water Quality Basin Plan Objective Relating to Nutrients and/or Eutrophication*

The SDRWQCB Basin Plan includes two objectives that have applicability towards eutrophication in enclosed bays and estuaries: 1) dissolved oxygen, and 2) biostimulatory substances (Table 6.2).

**Table 6.2. SDRWQCB Basin Plan objectives for oxygen and biostimulatory substances (SDRWQCB Basin Plan).**

Indicator	Objectives
<b>Dissolved Oxygen</b>	Dissolved oxygen levels shall not be less than 5.0 mg L <sup>-1</sup> in inland surface waters with designated MAR or WARM beneficial uses or less than 6.0 mg L <sup>-1</sup> in waters with designated COLD beneficial uses. The annual mean dissolved oxygen concentration shall not be less than 7 mg L <sup>-1</sup> more than 10% of the time.
<b>Bio-stimulatory Substances</b>	Inland surface waters, bays and estuaries and coastal lagoon waters shall not contain biostimulatory substances in concentrations that promote aquatic growth to the extent that such growths cause nuisance or adversely affect beneficial uses.  Threshold total phosphorus (P) concentrations shall not exceed 0.05 mg L <sup>-1</sup> in any stream at the point where it enters any standing body of water, nor 0.025 mg L <sup>-1</sup> in any standing body of water. A desired goal in order to prevent plant nuisance in streams and other flowing waters appears to be 0.1 mg L <sup>-1</sup> total P. These values are not to be exceeded more than 10% of the time unless studies of the specific water body in question clearly show that water quality objective changes are permissible and changes are approved by the Regional Board. Analogous threshold values have not been set for nitrogen compounds; however, natural ratios of nitrogen to phosphorus are to be determined by surveillance and monitoring and upheld. If data are lacking, a ratio of N:P = 10:1, on a weight to weight basis shall be used. Note - Certain exceptions to the above water quality objectives are described in Section 4 in the subsections titled Discharges to Coastal Lagoons from Pilot Water Reclamation Projects and Discharges to Inland Surface Waters.

*Alternative Numeric Targets for Eutrophication*

The purpose of this section is to provide information on alternative numeric targets to address eutrophication in Loma Alta Slough.

Several studies have demonstrated the shortcomings of using ambient nutrient concentrations alone to predict eutrophication, in streams (Welch et al. 1989, Fevold 1998, Chetelat et al. 1999, Heiskary and Markus 2001, Dodds et al. 2002) and estuaries (Cloern 2001, Dettman et al. 2001, Kennison et al. 2003).

Use of ambient, surface water nutrient concentrations is generally not effective for assessing eutrophication and the subsequent impact on beneficial use because ambient concentrations reflect the biological processing that has already occurred. For example, macroalgae can take up nutrients with such high efficiency that they leave near non-detectable concentrations in the surface waters. In Loma Alta Slough, this phenomenon was evident as during the summer 2008 when some of the highest biomass levels found in the Southern California Bight were recorded in the Slough, while surface water nutrient concentrations generally met basin plan objectives.

Over the past decade, US EPA Region 9 and the California State Water Resources Control Board (SWRCB) have been developing a science-based approach to translate narrative water quality objectives for nutrients and biostimulatory substances to numeric targets for lakes and streams (EPA 2006). The SWRCB staff strategy is to develop a narrative objective for nutrients and biostimulatory objectives, plus numeric guidance that would be incorporated by default into the Basin Plans of the Regional Water Quality Control Boards. This numeric guidance is referred to as the Nutrient Numeric Endpoint (NNE) Framework. The NNE framework consists of two key tenets:

- 1) Use of ecological response indicators rather than nutrients to assess risk to beneficial uses from eutrophication,
- 2) Models to link response indicator endpoints to site-specific nutrient targets.

Numeric endpoints are developed for indicators of the ecological response of the waterbody to eutrophication (e.g. algal biomass, dissolved oxygen, pH), rather than nutrients. Though NNE assessment framework is not yet adopted, two reports and two journal articles (Green et al. (in review) and Sutula et al. (in press) completed by that project are useful as a starting point discussions on numeric targets for Loma Alta Slough. The two reports include:

- A comprehensive review of ecological response indicators and science to support decisions on numeric thresholds (Sutula 2011).
- A review of science supporting dissolved oxygen objectives in estuaries (Sutula et al. 2012).

Selection of NNE indicators and applicable thresholds for Loma Alta Slough must map on to the relevant beneficial uses affected by eutrophication. Table 6.3 lists the applicable estuarine beneficial uses for Loma Alta Slough and their definitions.

Sutula (2011) and Sutula et al. (2012) provide a comprehensive review of candidate indicators and science available to support threshold selection. Sutula et al. (2011) used an explicit set of review criteria to determine whether an indicator was suitable for use to assess eutrophication. They also provide background on classification of California estuaries and key habitat types relevant to California estuaries. Based on this information, Loma Alta Slough would be classified as an intermittently tidal river mouth estuary. When open, the Slough is dominated by macroalgae; when closed, the Slough has a combination of macroalgae and phytoplankton (Figure 2; McLaughlin et al. 2010).

**Table 6.3. Definition of estuarine beneficial uses applicable to selection of E-NNE indicators.**

**Estuarine Habitat (EST)** -Uses of water that support estuarine ecosystems including, but not limited to, preservation or enhancement of estuarine habitats, vegetation, fish, shellfish, or wildlife (e.g., estuarine mammals, waterfowl, shorebirds).

**Warm Freshwater Habitat (WARM)** – Uses of water that support warm water ecosystems including, but not limited to, preservation or enhancement of aquatic habitats, vegetation, fish or wildlife, including invertebrates.

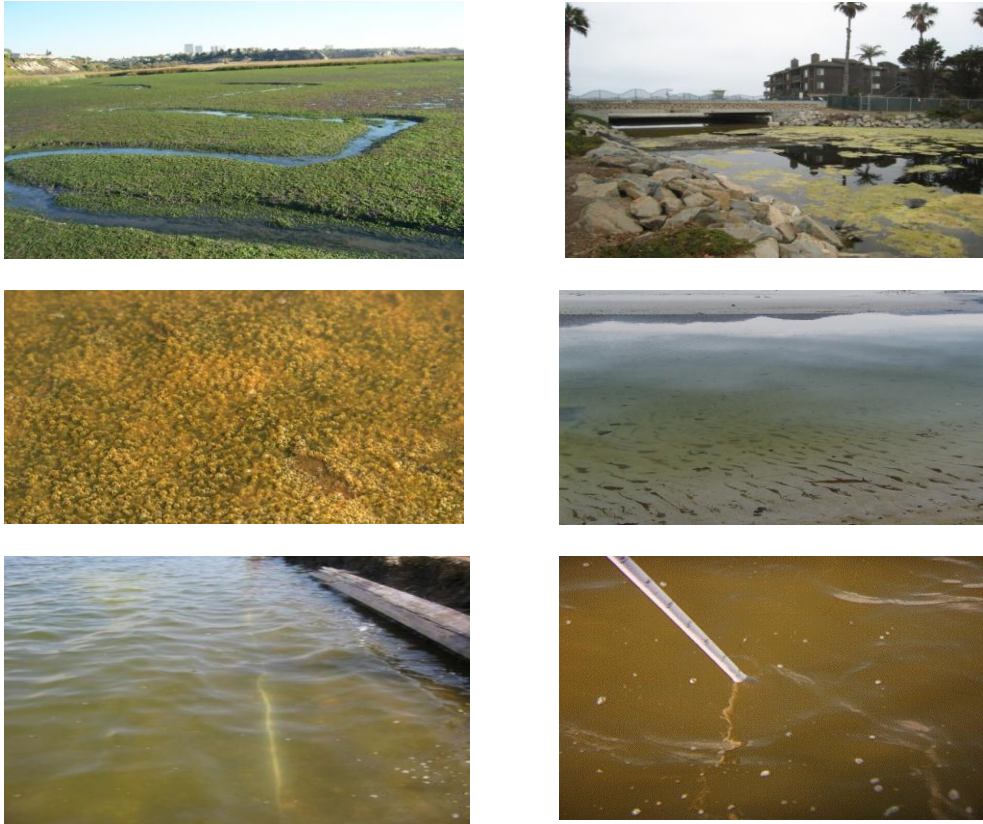
**Contact Water Recreation (REC-1)** – Uses of water for recreational activities involving body contact with water, where ingestion of water is reasonably possible. These uses include, but are not limited to, swimming, wading, water-skiing, skin and SCUBA diving, surfing, white water activities, fishing, or use of natural hot springs.

**Non-contact Water Recreation (REC-2)** – Uses of water for recreational activities involving proximity to water, but not normally involving body contact with water, where ingestion of water is reasonably possible. These uses include, but are not limited to, picnicking, sunbathing, hiking, beachcombing, camping, boating, tidepool and marine life study, hunting, sightseeing, or aesthetic enjoyment inconjunction with the above activities.

A simple conceptual model of estuarine ecological response to eutrophication can be described. The increased nutrient loads and alterations in co-factors can result in three types of ecological response: 1) changes to aquatic primary producers, 2) altered water and sediment biogeochemistry, and 3) altered community structure of secondary (invertebrates) and tertiary consumers (fish, birds, mammals). These ecological responses include adverse effects on both ecological and human endpoints of concern. This cascade of effects has a direct effect on the ecosystem services and beneficial uses an estuary provides, including reduced: 1) Habitat for aquatic life (including EST, MAR, WILD), 2) Protection of biodiversity including rare, threatened and endangered species and migratory and spawning habitat (RARE, SPWN, MIGR), 3) Productivity of commercial and recreational fisheries (SHELL, COMM, AQUA), 4) Good aesthetics and lack of odors (REC2), and 5) Maintenance of good water quality and taste (REC1, COMM, AQUA, SHELL).

Of these indicator reviewed, three subgroups are recommended for further development under the NNE framework: 1) dissolved oxygen, 2) macroalgae, 3) and phytoplankton. The applicability of these indicators groups is given as a function of whether the estuary is “open” or “closed” to tidal influence and habitat type. The status of the estuary as “open” or “closed” maps back to estuarine class, specifically with respect to its designation as perennially, intermittently, or ephemerally tidal. Thus a perennially tidal estuary is “open” year round, while an intermittently or ephemerally tidal estuary is “open” for some time period and “closed” for others. Thus in Loma Alta Slough, applicable indicators would include macroalgae and dissolved oxygen when the Slough is “open” or “closed” to tidal exchange. Though phytoplankton may be an applicable indicator in Loma Alta Slough, field observations indicate that phytoplankton biomass is small relative to macroalgae (McLaughlin et al. 2010).





**Figure 6.2. Examples of three types of primary producers found in Loma Alta Slough: macroalgae on tidal flats (top left) and floating macroalgae during a closed inlet (top right), microphytobenthos (mid panel) and phytoplankton (bottom panel).**

*Literature Review Supporting Numeric Targets for Dissolved Oxygen and Macroalgae*

**Dissolved Oxygen.** The San Diego RWQCB has existing dissolved oxygen objectives for estuaries ([www.waterboards.ca.gov](http://www.waterboards.ca.gov)). Sutula et al. (2012) recently completed a review of science supporting dissolved oxygen objectives in California estuaries. Sutula et al. (2012) found that there were insufficient data to derive criteria for native California species. Ultimately, by using data from surrogate and introduced species, the minimum data requirements for calculation of acute and chronic criteria were met. In addition, there was sufficient species representation to derive separate *acute* criteria for northern and southern California for both estuaries open to tidal exchange and intermittently closed systems. Conversely, there were insufficient data to derive separate *chronic* criteria based on region or estuary type. Thus, while the report may ultimately help to move all Regional Boards towards a similar approach to setting dissolved oxygen objectives, the report has not undergone sufficient review to consider alternative numeric thresholds at this time. Two issues raised in this report however are relevant for considering how the existing DO basin plan objective is interpreted. First, the report notes that hypoxia in bottom waters is a natural occurrence in bar-built estuaries, particularly when the mouth is closed, due to due to salinity stratification. Therefore application of the DO basin plan objective throughout the water column may be unreasonable. Second, the report recommends that acquiring

data from a reference estuary to better establish the percentage of time in which existing basin plan objectives would be exceeded. A dissolved oxygen reference study for Loma Alta Slough is under discussion.

**Macroalgae.** Sutula et al. (2011) provides a complete synthesis of the status of science to develop numeric endpoints for macroalgae. The EU Water Framework Directive has proposed class limits for macroalgal biomass and cover (Scanlan et al 2007; Zaldivar et al. 2008), with consideration of percent cover and biomass separately (Table 6.4). In intertidally dominated estuaries, macroalgae is typically assessed on intertidal flats or shallow subtidal habitat, and are therefore expressed on an areal basis ( $\text{g dw m}^{-2}$ ). As an index area in the intertidal zone, macroalgae is typically assessed on a transect at MLHW or 0.75 m Below Mean Low Tide (MTL).

**Table 6.3. EU WDF proposed classification of macroalgal abundance as a function of dry weight biomass and percent cover (from Scanlan et al. 2007). Scanlan et al. (2007) wet weight values were transformed to dry weight using Bight 08 Eutrophication Assessment data (McLaughlin et al., in press). Combination of biomass and cover are ranked from low macroalgal abundance = very high ecological condition (blue) to high macroalgal abundance = very low ecological condition (red).**

Biomass ( $\text{g dw m}^{-2}$ )	Percent Cover				
	<5%	5 to 15%	15 to 25%	25 to 75%	>75%
> 400	Moderate	Low	Very Low	Very Low	Very Low
130 to 400	Moderate	Moderate	Low	Very Low	Very Low
70 to 130	Good	Moderate	Moderate	Low	Low
10 to 70	Very High	Good	Good	Moderate	Low
< 10	Very High	Good	Good	Moderate	Moderate

Additional studies were funded by the SWRCB to support the establishment of regulatory thresholds (Sutula et al. in press; Green et al, in review). Sutula et al. (2012) found an envelope of reference conditions in eight California estuaries of 3 to 15  $\text{g dw m}^{-2}$ . Lowest observed adverse effects were documented experimentally by Green et al. (in review) at 110 to 120  $\text{g dw m}^{-2}$  after a duration of 2 to 6 weeks. This value was similar to that documented by Bona (2006) of 90  $\text{g m}^{-2}$  via benthic camera survey at which larger bivalves and surface deposit feeders were lost. Sutula et al. (in press) documented severe adverse effects at 175 to 190  $\text{g dw m}^{-2}$ , similar levels to that found by Green (2011) in a field experiment which produces high porewater sulfide (190  $\text{g dw m}^{-2}$ ). Two studies provide some information on “no effect” thresholds. A field experiment by Cardoso et al. (2004) found a positive effect on invertebrate diversity and abundance at approximately 30  $\text{g dw m}^{-2}$  (Cardoso et al. 2004). Similarly, Green (2011) found that levels approximating 30  $\text{g dw m}^{-2}$ ; our confidence that this finding represents a no-effect benchmark is low, as in either study the treatment was not a continuous application. Nevertheless these latter two studies help to narrow the uncertainty in where an initial threshold of adverse effects likely lie (i.e., >30  $\text{g dw m}^{-2}$  but <90  $\text{g dw m}^{-2}$ ).

In estuaries where rafting macroalgae is found in subtidal habitat, it is necessary to express macroalgal biomass as a volumetric number. In order to translate areal thresholds to volumetric numbers, the areal biomass is divided by 0.75 m, representing the average water depth that a transect of macroalgae assessed at MLHW, the location in which macroalgae is typically assessed in field surveys and experiments (Sutula et al. in press, Green et al. submitted; Table 6.4)

Table 6.4 EU WDF proposed classification of macroalgal abundance as a function of volumetric dry weight biomass and percent cover (from Scanlan et al. 2007). Volumetric biomass was transformed by dividing areal biomass (Table 7) by 0.75 m.

Biomass <sup>-3</sup> (g dw m )	Percent Cover				
	<5%	5% to 15%	15% to 25%	25% to 75%	> 75 %
>530	Moderate	Low	Very Low	Very Low	Very Low
175-530	Moderate	Moderate	Low	Very Low	Very Low
90-175	Good	Moderate	Moderate	Low	Low
10-90	Very High	Good	Good	Moderate	Low
<10	Very High	Good	Good	Moderate	Moderate

With respect to % cover, Bona (2006) establish cover > 60% associated with adverse effects. Scanlan et al. (2007) adopted <5% cover of opportunistic macroalgae as a reference level (equivalent to High quality status) and propose <15% (=5–15%) cover of opportunistic macroalgae as a threshold level for acceptable cover where biomass is also low . It considers >75% cover as seriously affecting an area, and this could possibly form a threshold for Poor/Bad status with 25–75% delineating a Moderate/Poor band, and 15–25% Moderate.

While there is no published information on % cover of floating algae in estuaries that becomes undesirable from a recreational perspective, several studies have been done on streams in New Zealand and Montana, indicating that when macroalgae reaches levels of 50-80% cover, the stream becomes undesirable to recreate (Biggs 2000, Supplee et al. 2009).

#### [Calculation of Numeric Targets for Dissolved Oxygen, Macroalgae, and Nutrient Concentrations](#)

At the March 6 and 27, 2012 meetings, the stakeholders, the SDRWQCB , and EPA Region 9 staff discussed temporal and spatial aggregation of data for interpretation of dissolved oxygen, macroalgae and surface water nutrient concentrations. For macroalgae and nutrient concentrations, model output was used to inform these discussions. A synopsis of the discussion is presented below.

Stakeholders and regulatory staff acknowledged that TMDLs calculated using existing biostimulatory objectives versus the macroalgal NNE target would be different. The group consensus was to run the

numbers to calculate the TMDL and compare using the two types of numeric targets. The decision on what to use would be presented in the staff report

**Dissolved Oxygen.** Discussion and consensus on the dissolved oxygen numeric target revolved around five points:

- *What are the appropriate numeric target?* Consensus on the Basin Plan Objectives: Use 5 mg L<sup>-1</sup>, ignore 7 mg L<sup>-1</sup> average annual. All agreed that these endpoints could be revised in a reopener when a reference study is completed.
- *Should the objectives apply equally to wet versus dry weather, winter dry versus summer dry?* There was consensus that objectives should apply to all periods, though a reference study could help to better define permissible periods of non-compliance.
- *Should model output or monitoring data be used surface water only, bottom water only, or surface and bottom water averaged?* There was consensus on applying the objective in the surface water only, with reopener after reference study.
- *Should model output or monitoring data be used as instantaneous or averaged?* There was agreement, though not consensus, to monitor on continuous basis. Data should be processed to provide hourly running average of data.
- *Should some period of non-compliance be granted?* There was agreement on using 10th percentile to determine allowable compliance, with reopener after reference study.
- *Where should DO be monitored?* It was suggested and most agreed that DO be monitored for compliance at the boundary condition

**Macroalgae.** At the March 6, 2012 meeting, stakeholders discussed and make made recommendations (or counter points) to EPA and RB 9 recommendations on the following issues regarding the use of macroalgae as a numeric target. Discussion and consensus on the macroalgal numeric target revolved around six points:

- *Should target be expressed as wet weight or dry weight?* Consensus was on the use of dry weight rather than wet weight.
- *Should numeric target be expressed as g m<sup>-2</sup> or g m<sup>-3</sup>?* Stakeholder consensus was to use as subtidal only (volumetric); no impairment for algae when the Slough is open, so no numeric target needed for intertidal.
- *What is the appropriate numeric target for biomass and cover?* Regulators recommended 90 g m<sup>-3</sup> for subtidal habitats. All agreed that this threshold should be subject to a reopener after the completion of a reference study. Regulators recommended less than 30% cover; stakeholders countered that <70% would be preferred and more reasonable based on a REC 2 threshold. Consensus was reached at <90 g m<sup>-3</sup> and <50% cover.
- *How should quadrat data be managed to generate transect level biomass and cover estimates?* Consensus was to use average of quadrat data.
- *How should the transect data be used to generate the biomass and cover estimates for a segment?* Use two transects approximately 70-100 m in length to cover above and below the railroad bridge. Maintain the data for the transects separate (e.g. can fail for any transect).

- *How should bloom duration be taken into account?* Use the average of two consecutive sampling periods: July and August

**Slough Surface Water Nutrient Concentrations.** Discussion focused on interpretation of existing basin plan biostimulatory objectives.

- *What are the appropriate numeric target? The Basin Plan Objectives?* Unless site-specific number is generated as part of TMDL, the regulators recommend: 1)  $> 0.05 \text{ mg L}^{-1} \text{ TP} + 0.5 \text{ mg L}^{-1} \text{ TN}$  when Slough closed;  $0.1 \text{ mg L}^{-1} \text{ TP} + 1 \text{ mg L}^{-1} \text{ TN}$  when Slough open. Stakeholders disagreed with the recommended numbers for when the Slough is closed, arguing that the Slough is not really a standing body of water. Group agreed to have both 0.05 and 0.1  $\text{mg L}^{-1}$  TP and translation to TN numbers to see what the comparison is with the TMDL generated to meet the macroalgal numeric target.
- *Where in the Slough? Entire Slough? Index area?* Group decided that they wanted to see at the head of estuary.
- *Should the objectives apply equally to wet versus dry weather, winter dry versus summer dry?* Apply during dry weather only, no distinction between winter and summer dry.
- *Should model output or monitoring data be used surface water only, bottom water only, or surface and bottom water averaged?* Stakeholder consensus on surface and bottom water averaged.
- *Should model output or monitoring data be used as instantaneous or averaged?* Stakeholder consensus on monthly average.
- *Should some period of non-compliance be granted?* Stakeholder consensus was on the 10th percentile allowable exceedance.

## 6.2 Use of Models to Calculate Total Maximum Daily Loads

The purpose of this section is to use the bacteria and eutrophication water quality models to calculate the total maximum daily loads required to meet the numeric targets. This calculation does not margin of safety.

### 6.2.1 Approach to Estimate TMDL

The approach used to calculate the TMDL was to run the model to reduce the wet weather (bacteria only) and dry weather (bacteria and nutrients) flow to a 0%, 10%, 25%, 50%, 90 and 99.9% reduction in freshwater flow measured in October 2007-2008 for bacteria and nutrients and May-October 2008 for macroalgae. A regression equation was used to fit the relationship between flow (dry weather) or load (wet weather) versus the numeric target.

#### Bacteria

For FIB, model output was averaged spatially from the ocean inlet to the railroad bridge. These data were then used to generate for the 8 a.m. sample, daily mean and 30-day geomean for dry weather and the 8 a.m. sample and daily mean for wet weather.

Over a course of 325 dry days per year, the data were used to generate the maximum, 95thile and 90<sup>th</sup>ile, of bacteria concentrations, corresponding to 0%, 5% and 10% allowable exceedance frequency respectively for each of the ways of calculating the standard (8 a.m. grab, daily mean, 30-day geomean of the daily mean) for each of flow reduction scenarios (no change (100%), 90, 75, 50, 10, and 0.1% of flow).

For the 40 wet weather days, a similar calculation was performed. The data were used to generate 78thile of bacteria concentrations, corresponding to 22% allowable exceedance frequency for each of the ways of calculating the single grab standard (8 a.m. grab, daily mean) for each of flow reduction scenarios (no change (100%), 90, 75, 50, 10, and 0.1% of flow).

### Eutrophication

Dissolved oxygen in the Slough was not responsive to nutrient loads (Section 5). Therefore it was not used in the calculation of the TMDL. For macroalgae, used average flow from May through October.

### Macroalgae and Nutrients

Macroalgae and nutrient concentrations were simulated over a course 325 dry days per year. The data were used to generate the 0 and 10 % allowable exceedance of biostimulatory objectives for each of flow reduction scenarios (no change (0%), 10, 25, 50, 90 and 99.9% reduction in dry weather flow). For macroalgae, data were processed only during the dry season (May-October), the designated critical period for macroalgal overgrowth.

## *6.2.2 Results and Discussion*

### Bacteria

Generally, analysis of the bacteria TMDL calculations show that the single grab standard for enterococcus would drives the TMDL allocation for both wet and dry weather. For dry weather, assuming a 0% allowable exceedance frequency, a dry weather diversion of 99.5 % of the freshwater flow from Loma Alta Creek would be required to meet the enterococcus numeric target (Table 6.5). The percent reduction required was no different between the daily mean and 8 a.m. grab sample. For fecal The range of flow reduction for fecal coliform ranged from 97% for fecal coliform to 85% for total coliform. Figures 6.3-6.5 show the linear regression relationship between flow reduction and FIB concentration using different methods of calculating the numeric target, including single sample (8 a.m. grab, daily mean) and 30-day geomean of the daily mean.

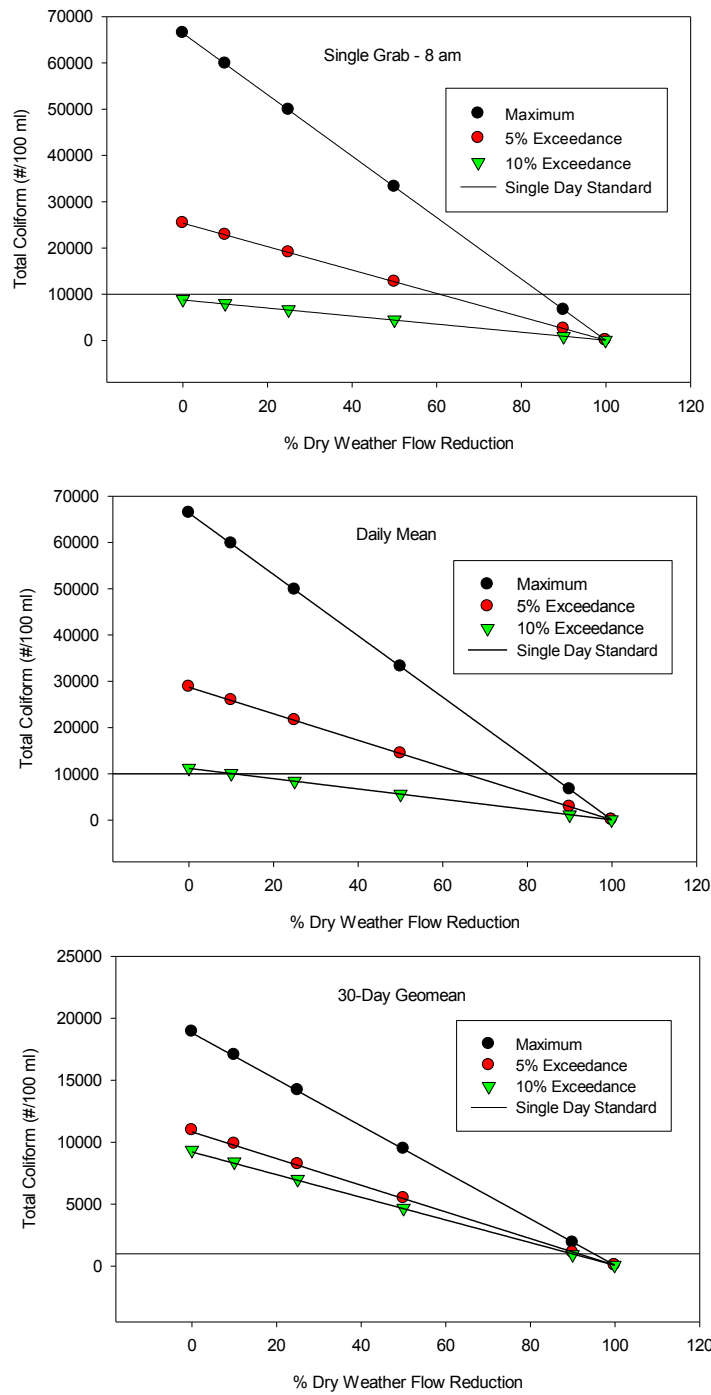
Similarly for wet weather, a 99.9% load reduction would be required to meet the enterococcus single grab standard in the Slough. A 97% reduction would be required to meet the fecal coliform standard, while an 80% reduction would be required to meet the total coliform standard. Figure 6.7 shows the linear regression relationship between FIB load reduction and Slough FIB concentration using different methods of calculating the numeric target, including 8 a.m. grab and daily mean.

**Table 6.5. Table of % reduction in dry weather flow required to meet FIB TMDL numeric targets. Slope (b) and y-intercept (a) refer to regression relationship used to extrapolate low reduction required to meet Slough FIB numeric targets. Ent = enterococcus, FC = fecal coliform, and TC = total coliform. Exceedance rate refers to allowable exceedance rate based (currently at 0%).**

FIB	Exceed- ance Rate	8:00 a.m. Grab			Daily Mean			30-day Geomean of Daily Mean		
		b	a	% Reduction	b	a	% Reduction	b	a	% Reduction
Ent	0%	-175.0	17506	<b>99.5</b>	-184.0	18408	<b>99.5</b>	-38.4	3859	<b>97.7</b>
	5%	-72.0	7212	<b>98.7</b>	-68.2	6832	<b>98.7</b>	-12.2	1266	<b>94.6</b>
	10%	-14.6	1484	<b>94.7</b>	-29.5	2972	<b>97.2</b>	-11.1	1137	<b>93.5</b>
FC	0%	-154.5	15495	<b>97.7</b>	-154.1	15448	<b>97.6</b>	-79.1	7943	<b>97.9</b>
	5%	-66.6	6704	<b>94.6</b>	-67.7	6816	<b>94.7</b>	-65.6	6592	<b>97.4</b>
	10%	-66.1	6652	<b>94.5</b>	-66.2	6656	<b>94.5</b>	-65.4	6568	<b>97.4</b>
TC	0%	-664.6	66481	<b>85.0</b>	-664.0	66411	<b>85.0</b>	-188.9	18922	<b>94.9</b>
	5%	-253.4	25398	<b>60.8</b>	-287.8	28814	<b>65.4</b>	-109.3	10963	<b>91.2</b>
	10%	-88.8	8919	<b>N/A</b>	-111.8	11233	<b>11.0</b>	-93.1	9343	<b>89.6</b>

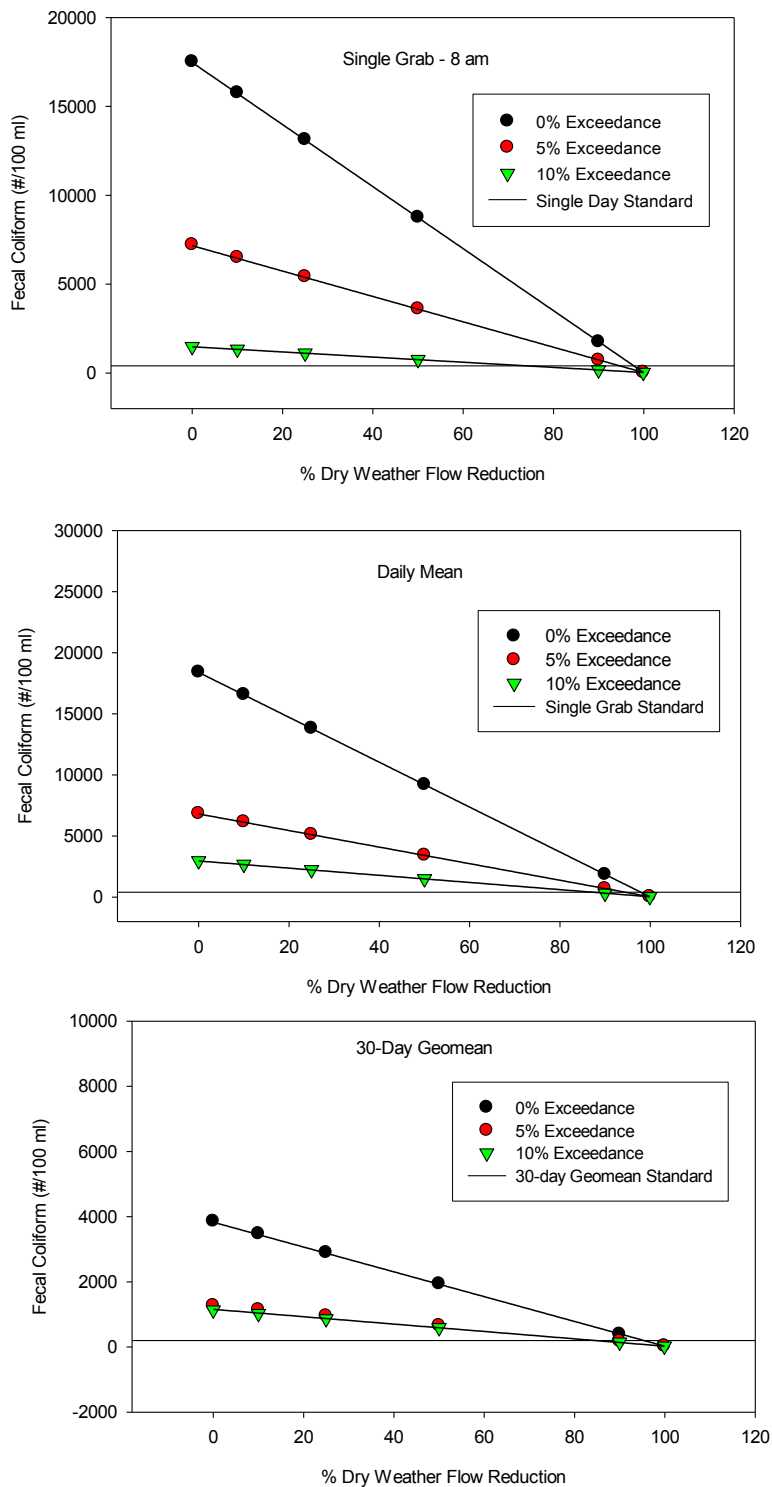
**Table 6.6. Table of % reduction in wet weather FIB loads required to meet FIB TMDL numeric targets. Slope (b) and y-intercept (a) refer to regression relationship used to extrapolate load reduction required to meet Slough FIB numeric targets. %Reduction refers to reduction in FIB load.**

FIB Numeric Target	8:00 a.m. Grab			Daily Mean		
	b	a	% Reduction	b	a	% Reduction
<b>Total Coliform</b>	-480.3	48056	<b>79.2</b>	-509.5	50976	<b>80.4</b>
<b>Fecal Coliform</b>	-111.3	11173	<b>96.8</b>	-104.6	10503	<b>96.5</b>
<b>Enterococcus</b>	-114.2	11651	<b>99.9</b>	-120.1	12108	<b>99.9</b>

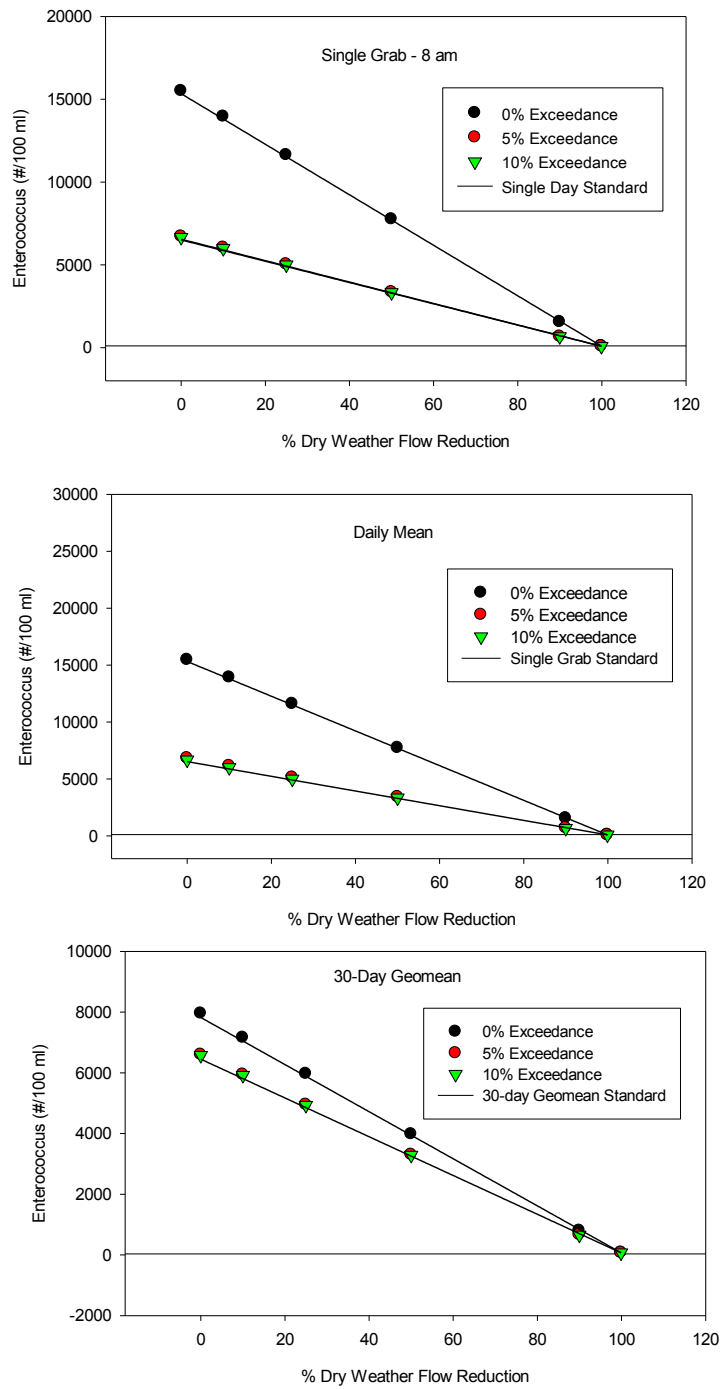


**Figure 6.3. Graphs showing analysis decline in total coliform concentration in Loma Alta Slough as a function of % reduction in dry weather flow for an 8:00 a.m. single grab event (top panel), daily mean (middle panel, and 30-day geomean (bottom panel). Graphs show allowable exceedance days at 0% (black), 5% (red) and 10% (green) of dry days per year.**

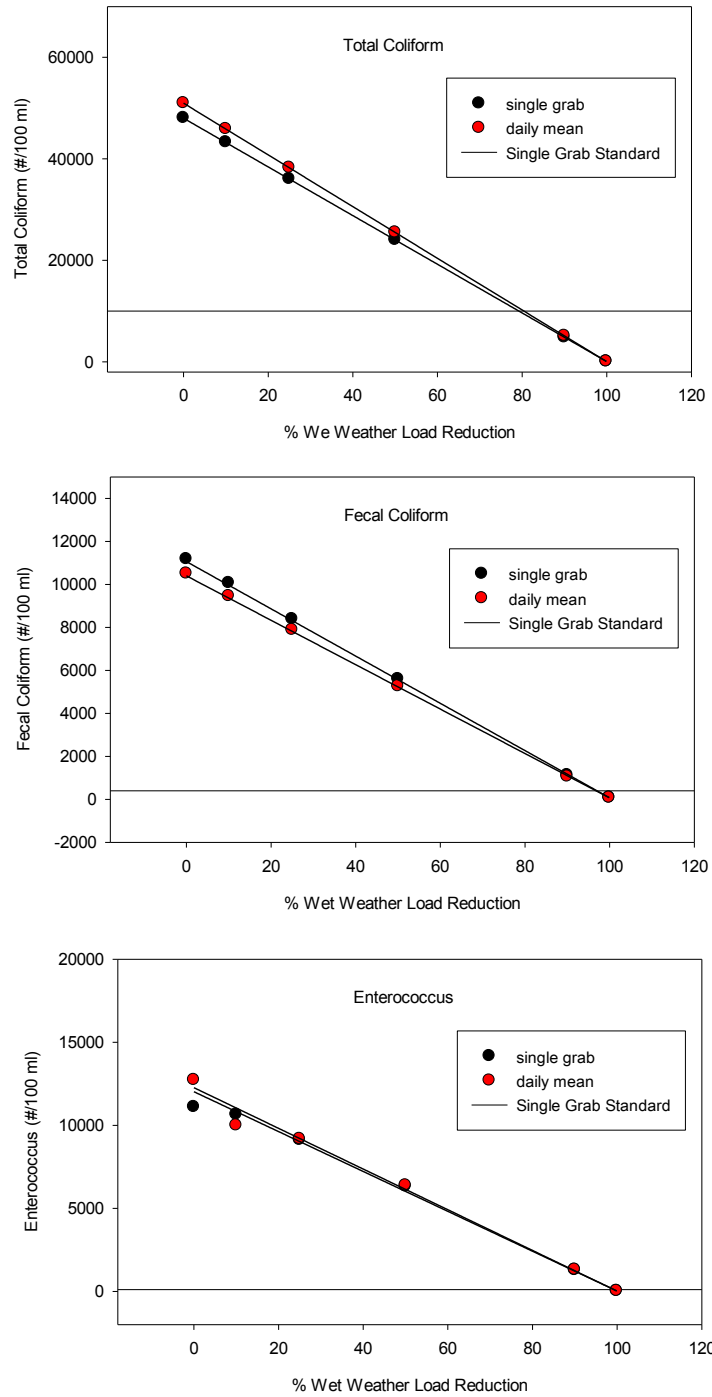




**Figure 6.4. Graphs showing analysis decline in fecal coliform concentration in Loma Alta Slough as a function of % reduction in dry weather flow for an 8:00 a.m. single grab event (top panel), daily mean (middle panel, and 30-day geomean (bottom panel). Graphs show allowable exceedance days at 0% (black), 5% (red) and 10% (green) of dry days per year.**



**Figure 6.5. Graphs showing analysis decline in enterococcus concentration in Loma Alta Slough as a function of % reduction in dry weather flow for an 8:00 a.m. single grab event (top panel), daily mean (middle panel), and 30-day geomean of daily mean (bottom panel). Graphs show allowable exceedance days at 0% (black), 5% (red) and 10% (green) of dry days per year.**



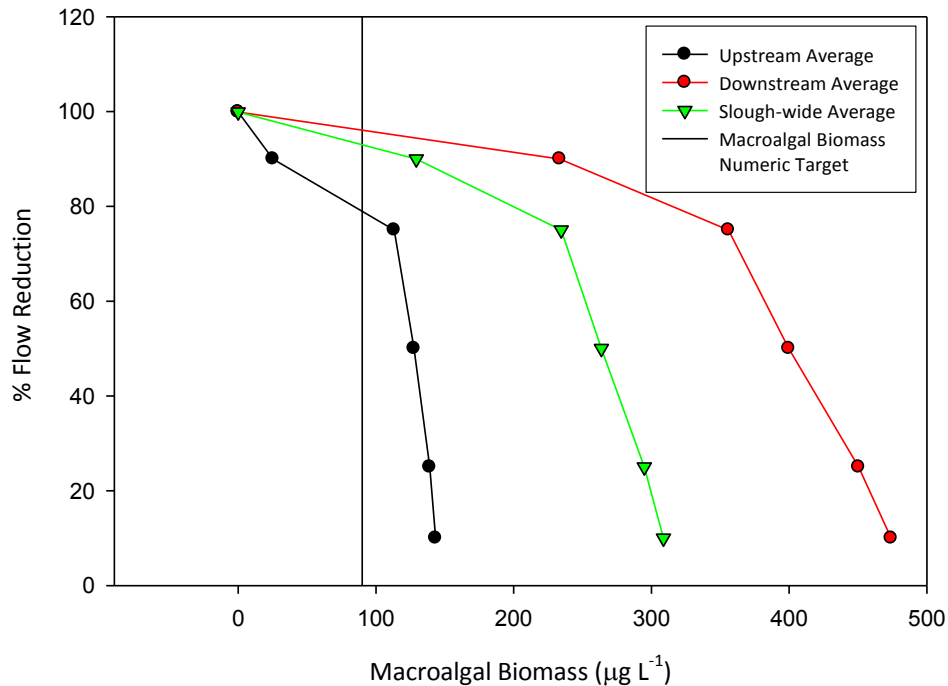
**Figure 6.6. Graphs showing analysis of decline of FIB concentration in Loma Alta Slough as a function of % reduction in wet weather FIB loads for an 8:00 a.m. single grab event (black) and daily mean (red) for total coliform (top panel), fecal coliform (middle panel) and enterococcus (bottom panel).**

Macroalgae and Nutrients

We estimate that a 81-96% reduction in TP and TN loads to the Slough during May –October are required to meet macroalgae numeric targets discussed in Section 6.1 (Table 6.7). Stakeholders and regulatory staff discussed how these targets should be met and specified that compliance should be met at both the upstream (Segment 1) and downstream (Segment 2) section of the Slough. However, the eutrophication model does not capture the drifting and spatial redistribution of algae (see Section 5). Therefore, we recommend that the Slough wide average be used to calculate the %load reduction required. Steep declines in the biomass are achieved with load reduction up to approximately 75%. After that, declines are more gradual.

**Table 6.7. Table of percent reduction in dry weather TN and TP loads required to meet macroalgal numeric target discussed in Section 6.1. Slope and y-intercept refer to regression relationship used to extrapolate low reduction required to meet the numeric target. Ocean inlet refers to the section downstream of the railroad bridge. Segment 1 (upstream) refers to the section of the Slough upstream of the railroad bridge to the Coast Highway.**

Segment Calculated	Slope	Intercept	% Load Reduction
Ocean Inlet (Downstream)	-0.207	99.9	81.3
Segment 1 (Upstream)	-0.0423	99.9	96.1
Average	-0.076	99.9	93.0



**Figure 6.7. Graphs showing analysis of decline in floating macroalgal biomass in Loma Alta Slough as a function of % reduction in dry weather flow, relative to the macroalgal biomass numeric target =  $90 \mu\text{g L}^{-1}$ .**

For nutrient concentration-based numeric targets, the load reduction is required to meet TN concentration targets (3-15% for TN = 1 mg L<sup>-1</sup> and 46-57% for TN = 0.5 mg L<sup>-1</sup>) was substantially less than that required to meet a macroalgal numeric target (Table 6.8: Figure 6.8). No reduction in TP loads would be required to meet TP numeric targets, regardless of the interpretation of the Basin Plan Biostimulatory Objective (Table 6.9, Figure 6.8); this problematic, recognizing that the Slough is P-limited for during the May-October critical period (McLaughlin et al. 2011).

**Table 6.8 Table of percent reduction in dry weather TN loads required to meet the TN numeric target based on a flowing waters (TN = 1 mg L<sup>-1</sup>) and standing water (TN = 0.5 mg L<sup>-1</sup>) interpretation of the Basin Plan Biostimulatory Objective. Ocean inlet refers to the section downstream of the railroad bridge. Segment 1 (upstream) refers to the section of the Slough upstream of the railroad bridge to the Coast Highway.**

Slough Segment	Slope	Intercept	% Reduction Required	
			TN = 1 mg L <sup>-1</sup>	TN = 0.5 mg L <sup>-1</sup>
Ocean inlet average	-99.4	96.5	NR	46.8
Segment 1 average	-92.3	100.7	8.4	54.5
Slough –wide Average	-86.7	101.9	15.1	58.5
Last four grid cells of model upstream	-95.9	98.7	2.9	50.8

**Table 6.9 Table of percent reduction in dry weather TN and TP loads required to meet the TN and TP numeric targets based on a flowing waters (TP = 0.1 mg L<sup>-1</sup>) and standing water (TP = 0.05 mg L<sup>-1</sup>) interpretation of the Basin Plan Biostimulatory Objective. Ocean inlet refers to the section downstream of the railroad bridge. Segment 1 (upstream) refers to the section of the Slough upstream of the railroad bridge to the Coast Highway.**

Slough Segment	Slope	Intercept	% Reduction Required	
			TP = 0.1 mg L <sup>-1</sup>	TP = 0.05 mg L <sup>-1</sup>
Ocean inlet average	-4939.3	139.4	NR	NR
Segment 1 average	-4009.6	122.5	NR	NR
Slough –wide Average	-2822.5	112.6	NR	NR
Last four grid cells of model upstream	-4455.5	130.5	NR	NR

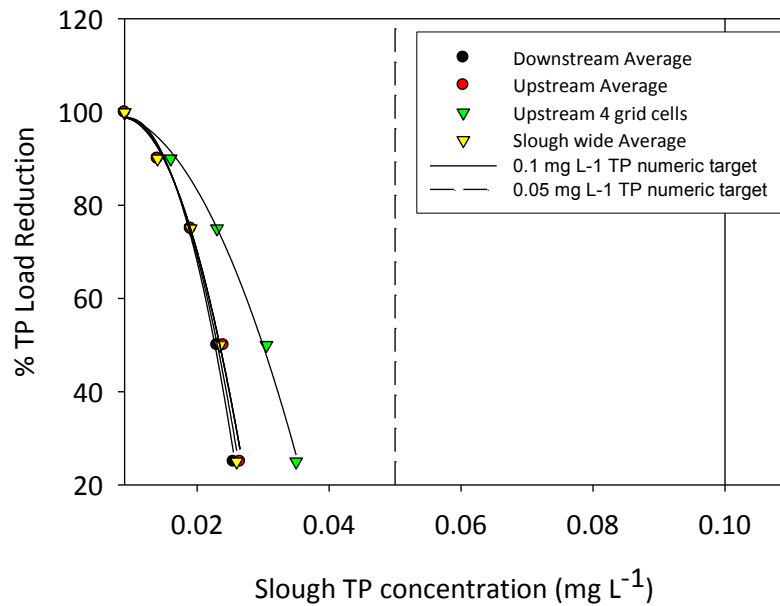
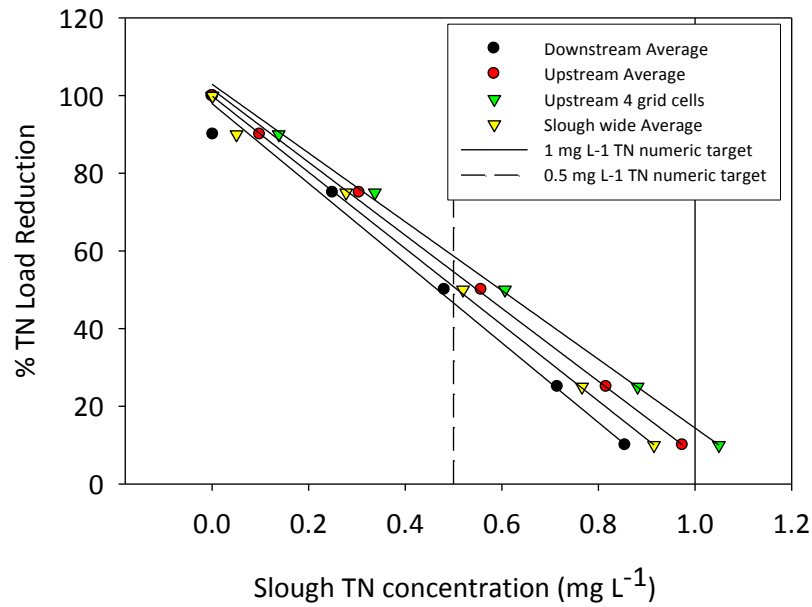


Figure 6.8. Graphs showing analysis of decline in TN (top panel) and TP (bottom panel) in Loma Alta Slough as a function of % reduction in dry weather TN or TP loads, relative to the numeric targets for flowing waters (1 mg L<sup>-1</sup> TN and 0.1 mg L<sup>-1</sup> TP ) and standing waters (0.5 mg L<sup>-1</sup> TN and 0.05 mg L<sup>-1</sup> TP).

### **6.3 Use of Models to Estimate Sources of Bacteria and Nutrients from Land Use**

One utility of a watershed stormwater runoff model is the ability to determine which land uses have the greatest nutrient and bacteria export. Since the watershed loading model was calibrated and validated for wet weather only, these results are applicable to wet weather load allocations. Additional source identification work is required in order to attribute nutrient and bacteria work to specific land uses within the Loma Alta Slough watershed.

#### *6.3.1 Methods*

To determine which land use has the greatest relative contribution (and thus the highest concentrations in surface runoff) a flux was calculated. This analysis was performed using the land use-specific runoff concentrations from Table 2.7 (nutrients) and Table 2.8 (bacteria) to drive the watershed load model for wet weather events during the 2007-2008 hydrological year. The loads attributable to each land use were derived and divided by modeled area to calculate flux (lb/ac/yr).

#### *6.3.2 Results and Discussion*

While the developed land uses had a higher nutrient overall loading in the watershed due to the greater runoff from impervious areas, the flux from the undeveloped areas were often at, or greater than the developed areas (Table 6.). Conversely, the bacterial flux from undeveloped areas were orders of magnitude lower than the developed with commercial and high density residential having the greatest outflow of bacteria (

Table 6.).

If the land use within the Loma Alta Slough watershed were to change from the modeled, the flux measurements could be used to estimate the typical loads from those lands.

**Table 6.7. Nutrient Land Use Flux (lb/ac/yr).**

<b>Land Use</b>	<b>Ammonia</b>	<b>Nitrite-Nitrate</b>	<b>Total Nitrogen</b>	<b>Dissolved Phosphorous</b>	<b>Total Phosphorous</b>
<b>Agriculture*</b>	4.42	30.45	45.67	7.13	31.68
<b>Commercial</b>	0.69	1.95	5.51	0.29	0.92
<b>High Density Residential</b>	0.62	2.49	6.19	0.48	1.67
<b>Industrial</b>	0.33	1.63	6.23	0.47	1.58
<b>Low Density Residential</b>	0.25	1.58	7.57	0.41	1.08
<b>Open</b>	0.14	1.31	7.89	0.40	0.95
<b>Open-Recreational</b>	0.13	1.19	7.25	0.37	0.88
<b>Transportation</b>	0.51	1.85	5.52	0.58	2.14



**Table 6.8. Bacteria Land Use Flux (10<sup>9</sup>/ac/yr).**

Land Use	Fecal Coliform	Total Coliform	Enterococcus
Agriculture*	0.30	7.47	1.00
Commercial	78.5	471.7	550
High Density Residential	471	963	393
Industrial	5.31	29.9	13.6
Low Density Residential	16.3	45.6	53.2
Open	0.30	7.47	1.00
Open-Recreational	13.1	38.0	42.7
Transportation	12.8	50.1	24.9

\* assumed to be equal to open

## 6.4 Use of Model to Analyze Implementation Scenarios

The purpose of this section is to present the results of management scenarios on modeled loads and/or concentrations of bacteria, nutrients and algal biomass.

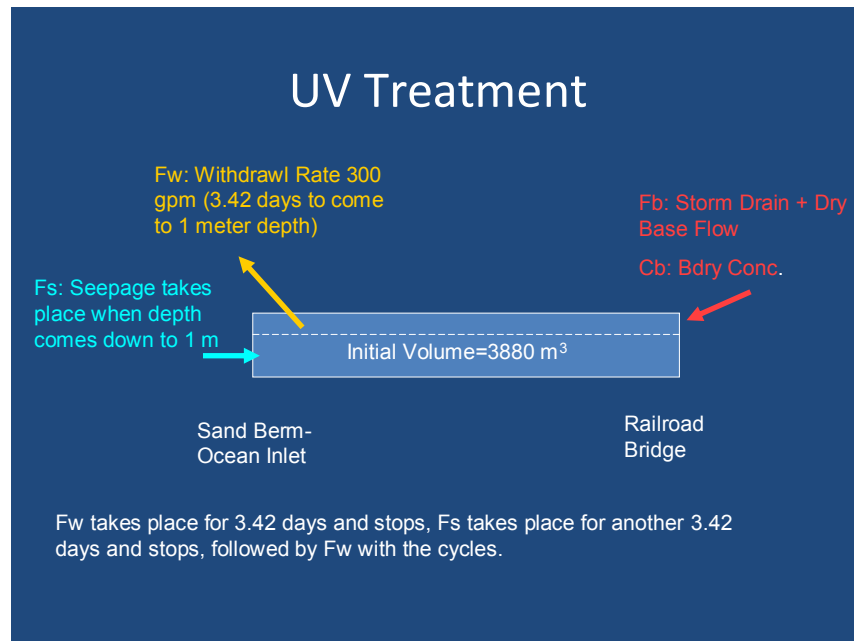
### 6.4.1 Methods

#### Scenarios to Address FIB Impairment

During the a series of stakeholders meeting, seven scenarios were identified for implementation for the bacteria modeling studies:

- Scenario #1. Existing condition (Inlet was open Nov 2007-May 2008 and closed May-Oct 2008)
- Scenario #2. Inlet is assumed to be open year-round (open from Nov 2007-Oct 2008)
- Scenario #3. Similar to Scenario #1, except with the sand berm height equal to the Mean Lower High Water (MLHW)
- Scenario #4. Watershed loads are reduced by 45% for wet weather loads and by 60% for dry weather loads
- Scenario #5. Combining Scenarios #2 and #4, open inlet with reduced loads
- Scenario #6. Replication of the effect of the existing UV treatment facility. Dilution under the existing condition when the inlet is closed. Slough water is withdrawn, treated and discharged to the ocean at rate of 300 gpm until the depth is decreased to 1 m. Then withdrawal stops and seepage from the ocean water continue to fill up the slough and withdrawal/seepage cycle continues. This process aims to, partially if not completely, replace or help alleviate the existing UV treatment facility.
- Scenario #7. Dilution scenarios, as described in Scenario #6 with reduced loads as described in Scenario #4

Methodology to simulate scenarios 6 and 7 require additional explanation. For Scenario, the downstream slough water is withdrawn at a rate of 300 gpm, which is then treated and discharged to the ocean. It is estimated to take 3-4 days to for the depth near Ocean Inlet dropping low to 1 m when the withdrawal ceases. Seepage from the ocean will refill the slough water back to its equilibrium water depth in three days. Once equilibrium water depth is reached, withdrawal of the slough water starts again and the withdrawal/seepage cycles continue. Figure 6.9 shows conceptual flow dilution for Scenario 6.



**Figure 6.9. Conceptual model for the scenario of dilution by withdrawal of slough water.**

The scenario can be defined and formulated by imposing the conservation laws to the volume and bacteria mass of the slough water, as shown in the following:

Conservation of water volume in the slough

$$\frac{\partial V(t)}{\partial t} = F_B - F_W + F_S$$

Conservation of bacteria in the slough water

$$\frac{\partial M(t)}{\partial t} = F_B C_B - F_W C$$

$$M(t) = V(t)C(t)$$

$$\frac{\partial C(t)}{\partial t} = \frac{F_B C_B - F_W C - C \frac{\partial V(t)}{\partial t}}{V(t)}$$

where  $V(t)$  is the volume of the slough water,  $F_B$ ,  $F_W$ , and  $F_S$  represent the dry season base flow, withdrawal rate of the slough water, and flow rate of seepage water from the ocean, respectively.  $M(t)$  and  $C(t)$  represent the total mass and the corresponding concentration of the slough water.

#### Scenarios to Address Eutrophication

**Berm Height/Inlet Closure.** Reduction of macroalgae biomass and total nutrient concentrations of the lagoon water is considered by way of adjusting closure/openness of the inlet in combination of load reduction during the May-Oct 2008 period. The following scenarios are defined in the stakeholder meeting and simulated. The results of concentrations of total-N, total-P and macroalgae biomass compared.

- Scenario #1: Current Condition (inlet closed)
- Scenario #2: Inlet is open
- Scenario #3: Inlet is open with berm height at Mean Lower Low Water (MLLW)
- Scenario #4: Inlet is closed with reduced load
- Scenario #5: Inlet is open with reduced load

#### 6.4.2 Results and Discussion of Scenario Analyses

##### Bacteria Scenarios

Simulation results as time series with and without a 30-day running window for scenarios #1-#5 are shown in Figures 6.9-6.12 and the days of exceedance based on the two criteria for single sample (wet and dry) and geomean of 30-d geomean (dry weather only) are calculated and shown in Table 6. -6.6. The exceedance days are generally the most for enterococcus. Scenario #5 (open inlet with reduced load) is the scenario in which the least amount of exceedance days were observed. However, the results illustrate that none of the scenarios would help the watershed achieve compliance with numeric targets.

**Table 6.9. Summary of scenario effects on number of exceedence days for enterococcus. Numbers incorporate the 22% allowable exceedence days for wet weather (n = 38 days) and 0% exceedence allowance for dry weather.**

Scenario	Dry Weather		Wet Weather
	SS Daily Mean	30-Day Geomean	SS Daily Mean
Current condition	187	365	187
Scenario #1: Current Condition (inlet closed)	254	365	254
Scenario #2: Inlet is open	95	264	95
Scenario #3: Inlet is open with berm height at Mean Lower Low Water (MLLW)	130	365	130
Scenario #4: Inlet is closed with reduced load	238	365	238
Scenario #5: Inlet is open with reduced load	86	264	86

**Table 6.10. Summary of scenario effects on number of exceedence days for enterococcus. Numbers incorporate the 22% allowable exceedence days for wet weather (n = 38 days) and 0% exceedence allowance for dry weather.**

Scenario	Dry Weather		Wet Weather
	SS Daily Mean	30-Day Geomean	SS Daily Mean
Current condition	128	365	88
Scenario #1: Current Condition (inlet closed)	254	365	214
Scenario #2: Inlet is open	95	272	55
Scenario #3: Inlet is open with berm height at Mean Lower Low Water (MLLW)	169	316	129
Scenario #4: Inlet is closed with reduced load	228	297	188
Scenario #5: Inlet is open with reduced load	87	270	47

**Table 6.11. Summary of scenario effects on number of exceedence days for enterococcus. Numbers incorporate the 22% allowable exceedence days for wet weather (n = 38 days) and 0% exceedence allowance for dry weather.**

Scenario	Dry Weather		Wet Weather
	SS Daily Mean	30-Day Geomean	SS Daily Mean
Current condition	48	209	9
Scenario #1: Current Condition (inlet closed)	57	294	19
Scenario #2: Inlet is open	52	151	14
Scenario #3: Inlet is open with berm height at Mean Lower Low Water (MLLW)	55	154	16
Scenario #4: Inlet is closed with reduced load	40	292	12
Scenario #5: Inlet is open with reduced load	36	150	13

The results for Scenario #6 and #7 are shown in Figure 6.155 - Figure 6.16, respectively. These figures illustrate that the simulations start the dilution process by withdrawing slough water and two initial concentrations were assumed for two simulation scenarios. For the first simulation, the initial concentrations of the slough water are set to be equal to the concentration when the inlet was closed (May 23, 2008). For the second simulation, the initial concentration is set to be equal to the loading concentration from the upstream boundary condition. For both simulation scenarios, slough water concentrations gradually converge to equilibrium concentrations after 90 days (in August, 2008). The equilibrium concentrations are 84% of the loading concentrations from the upstream watershed. That means that the dilution of the slough water is a physical process that exchanges and dilutes the slough water with ocean water through withdrawal and seepage processes. The dilution rate of 84% is irrelevant of the concentrations at the boundary conditions.

Scenario #7 assumes the combined use of reduced loads defined previously, and the dilution by withdrawing the slough water. Dilution rate of 84% of the reduced loads produces an equilibrium concentration less than those of the existing loading condition. Therefore, operation of the Slough dewatering and UV treatment result in 16% reduction in the FIB concentrations in the Slough.

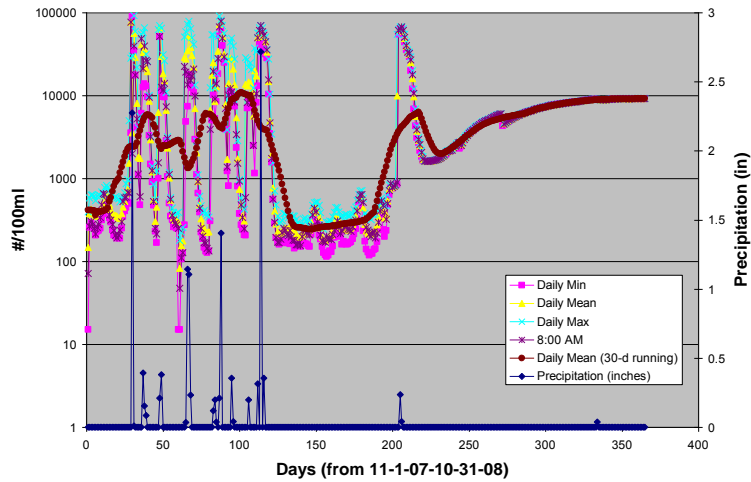
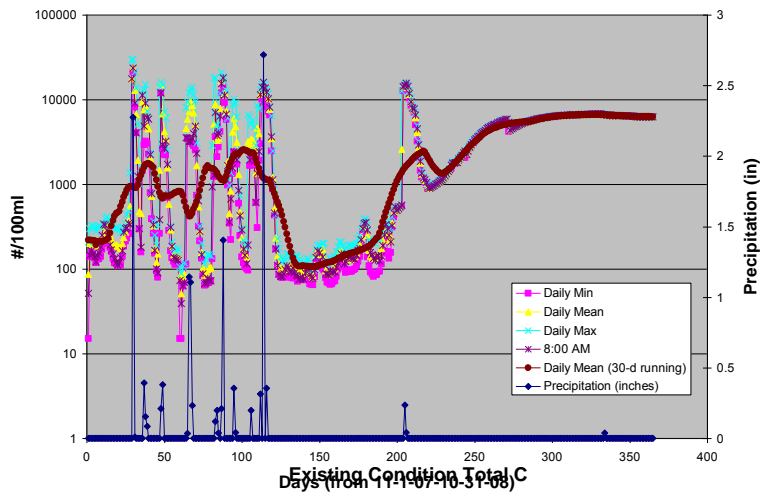
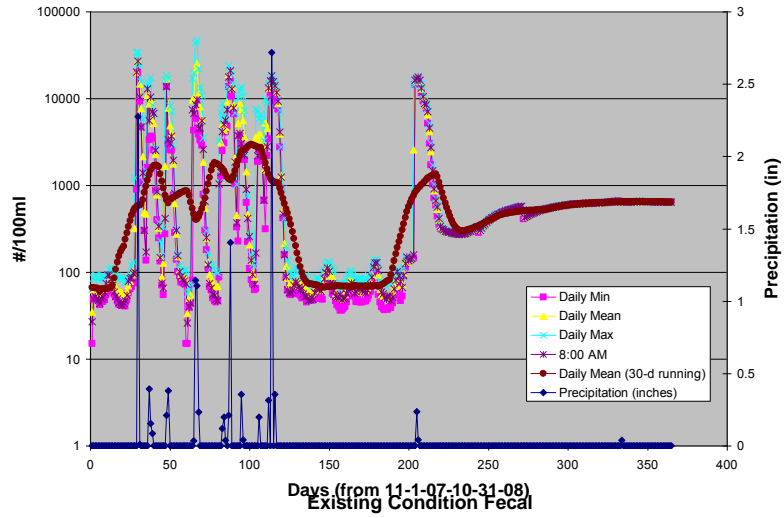


Figure 6.10. Scenario #1 Model Results: Enterococci (Above), Fecal Coliform (middle) and Total Coliform (bottom).

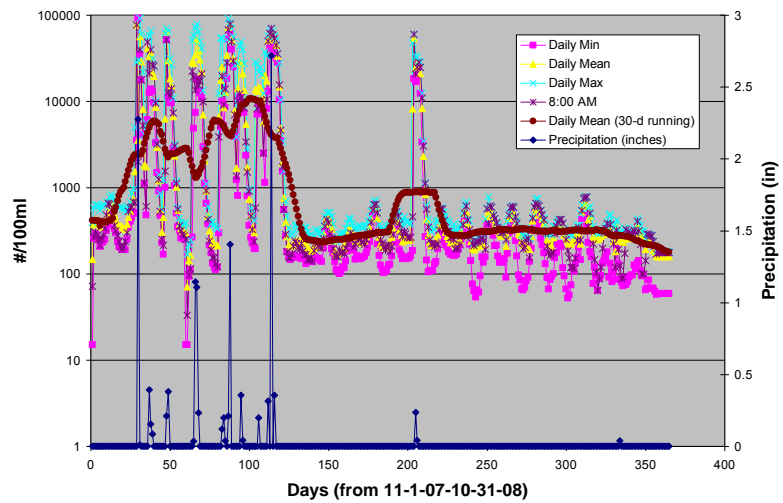
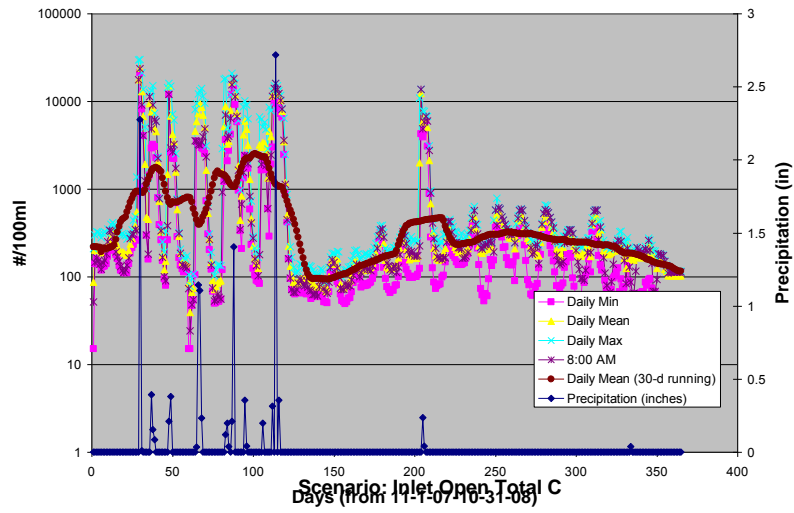
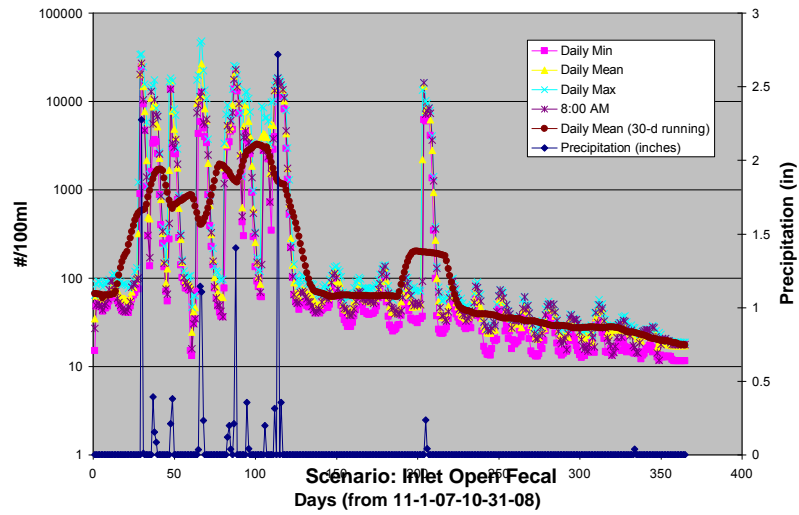


Figure 6.11. Scenario #2 Model Results: Enterococci (Above), Fecal Coliform (middle) and Total Coliform (bottom).

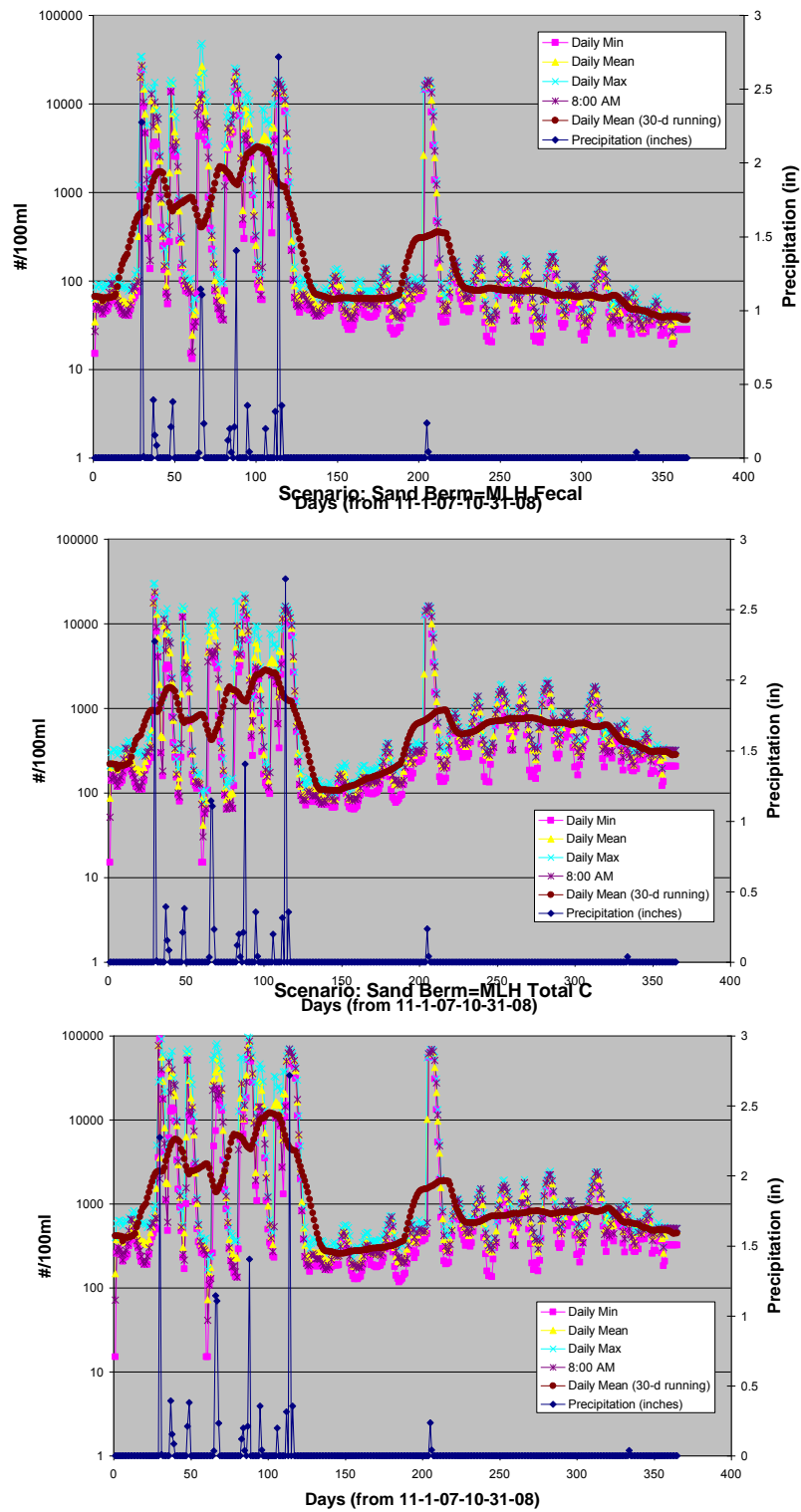


Figure 6.12. Scenario #3 Model Results: Enterococci (Above), Fecal Coliform (middle) and Total Coliform (bottom).



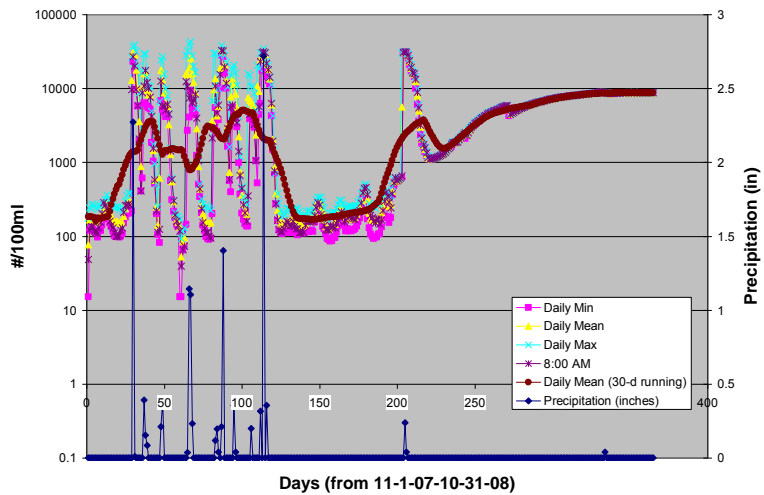
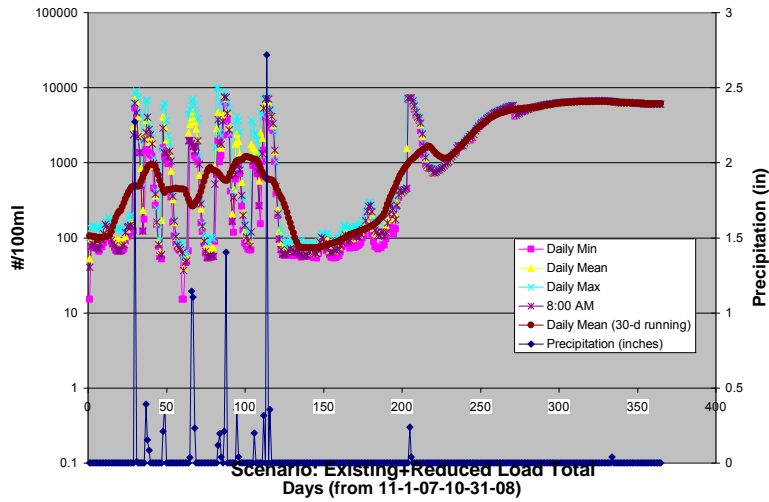
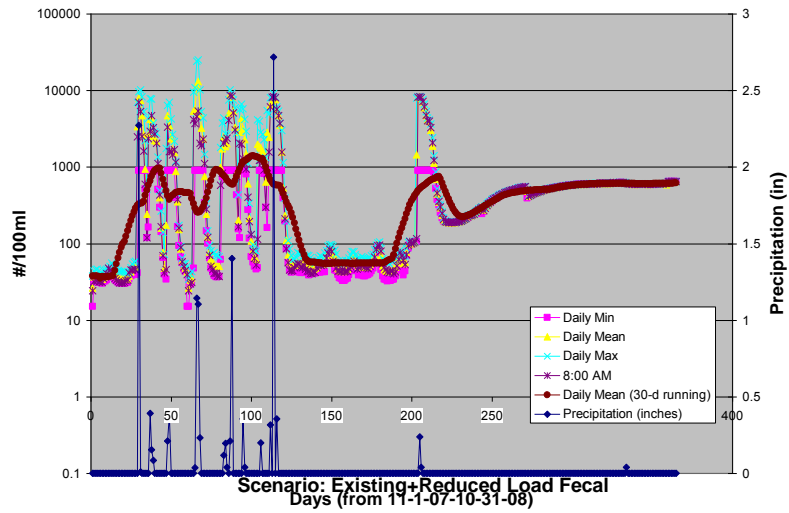


Figure 6.13. Scenario #4 Model Results: Enterococci (Above), Fecal Coliform (middle) and Total Coliform (bottom).

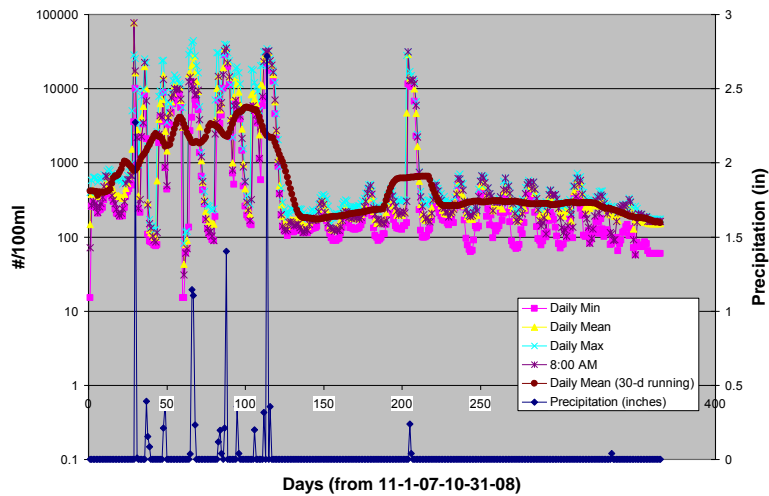
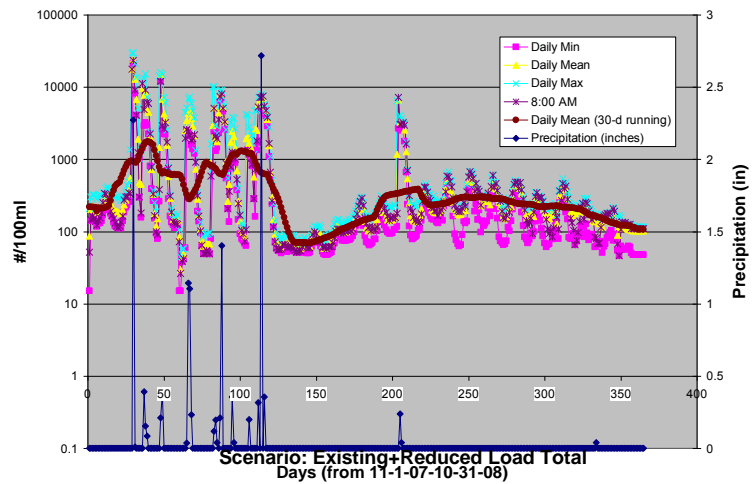
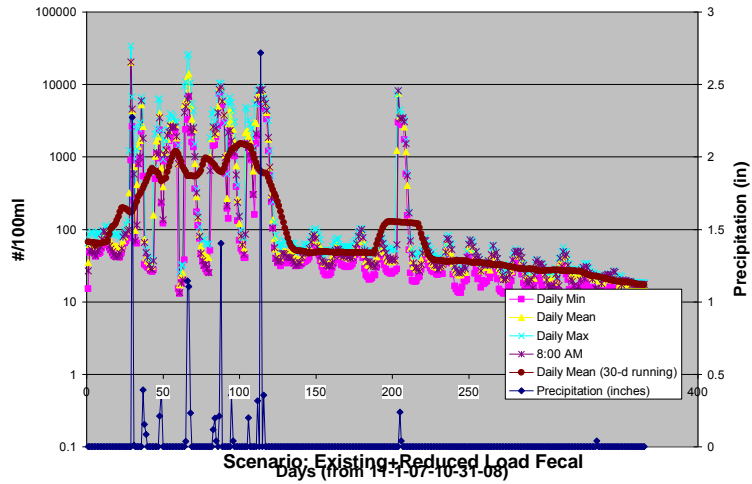


Figure 6.14. Scenario #5 Model Results: Enterococci (Above), Fecal Coliform (middle) and Total Coliform (bottom).

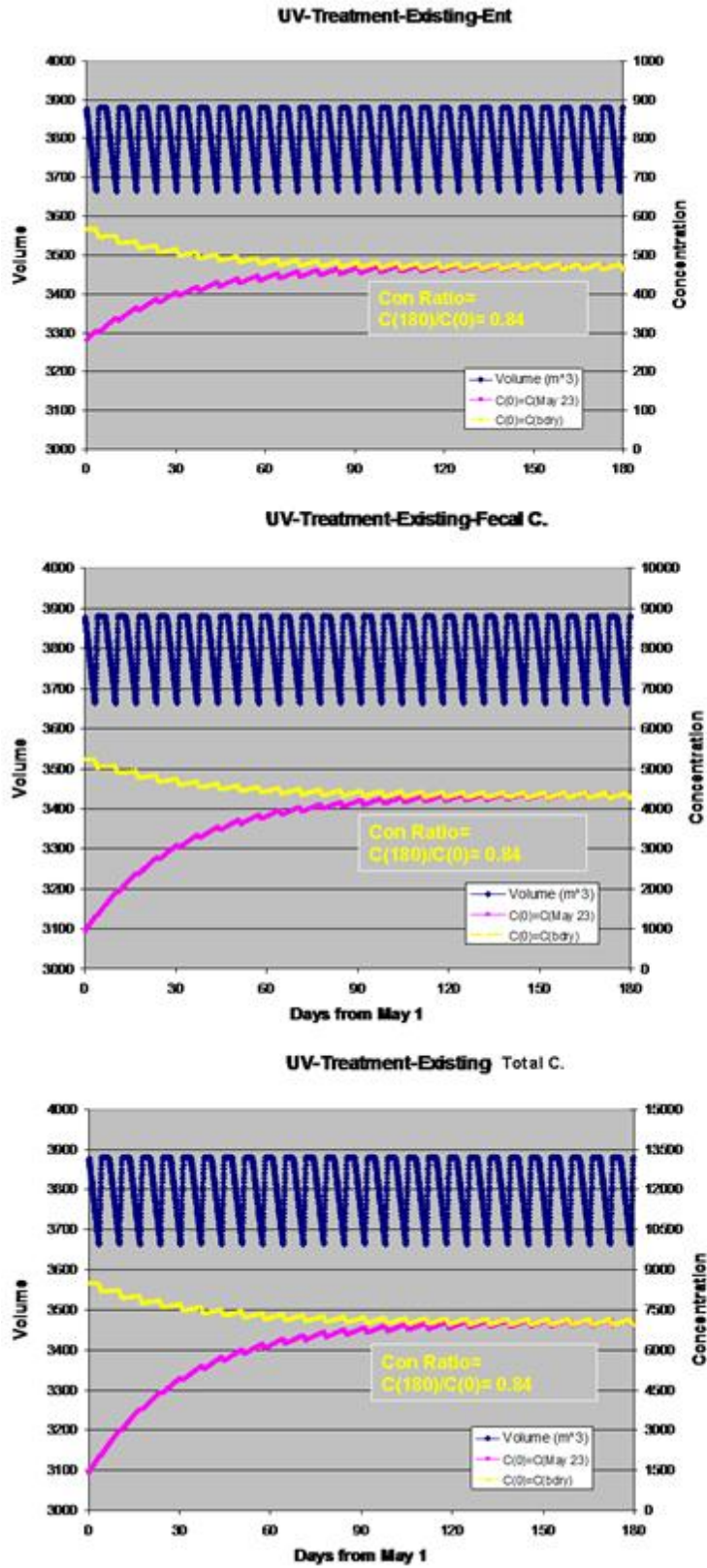


Figure 6.15. Concentrations for equilibrium for Scenario #6.

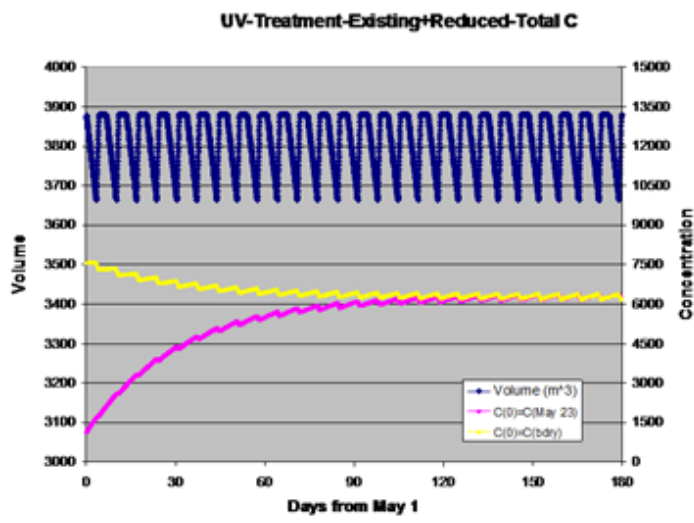
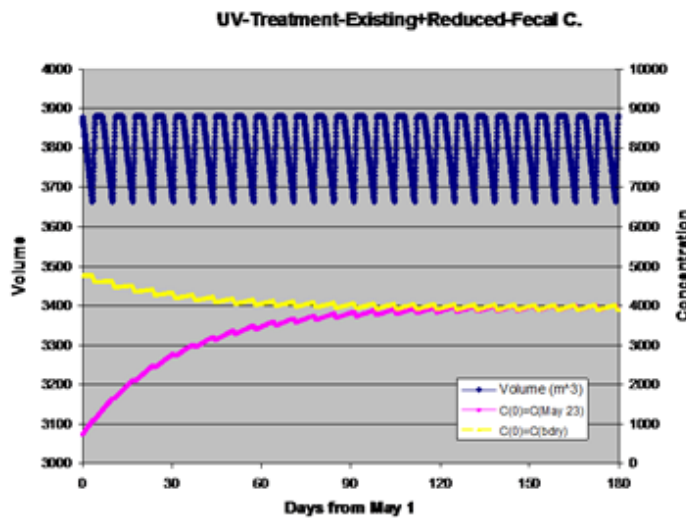
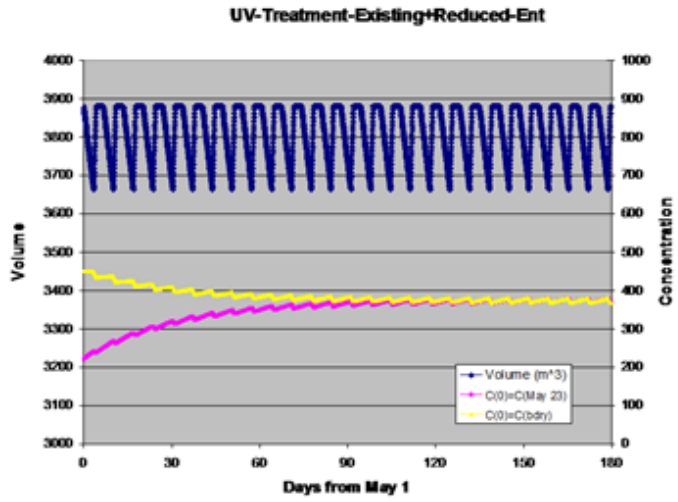


Figure 6.16. Concentrations for equilibrium for Scenario #7.

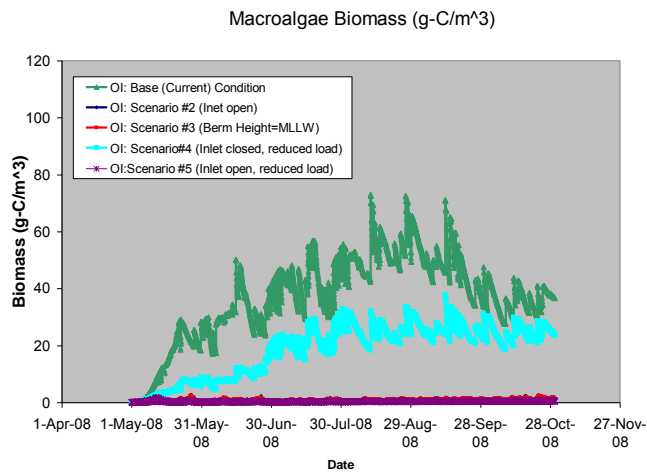
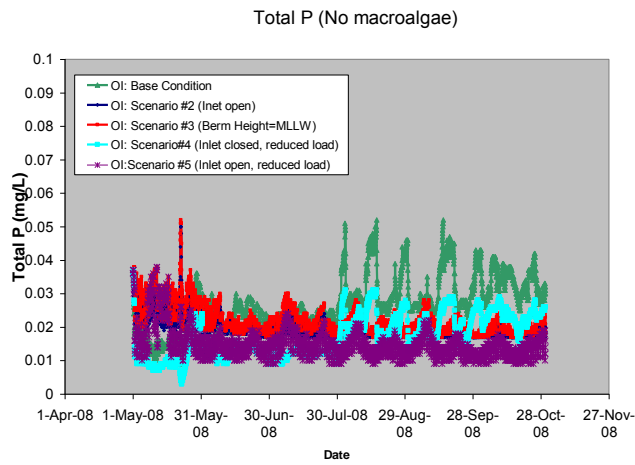
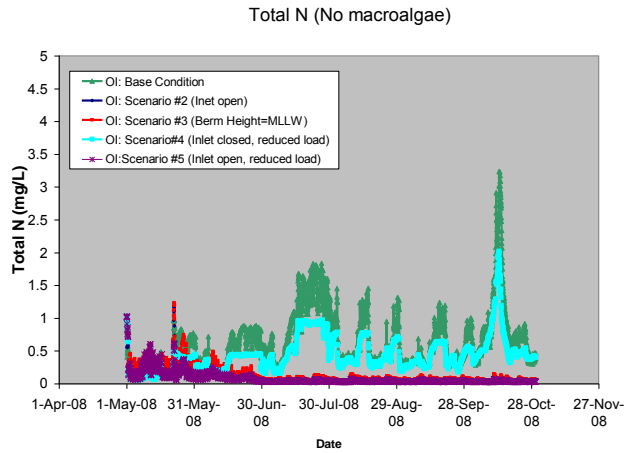
### *6.4.3 Results and Discussion of Eutrophication Scenarios*

Figure 6. and Figure 6.17 show that out of the 5 scenarios, Scenario #2 (open inlet), #3 ( berm height lowered and maintained at MHLW) and #5 (open inlet with reduced load) result in the lowest macroalgae biomass and total-N and total-P concentrations and would meet the TN and TP concentration as well as the macroalgal biomass numeric targets. In general, opening of the inlet, either fully open or half open at MLLH produces the most favorable conditions (least macroalgae biomass and lowest total nutrient concentrations. Load reduction was not sufficient to meet macroalgal numeric targets (see Section 6.2).

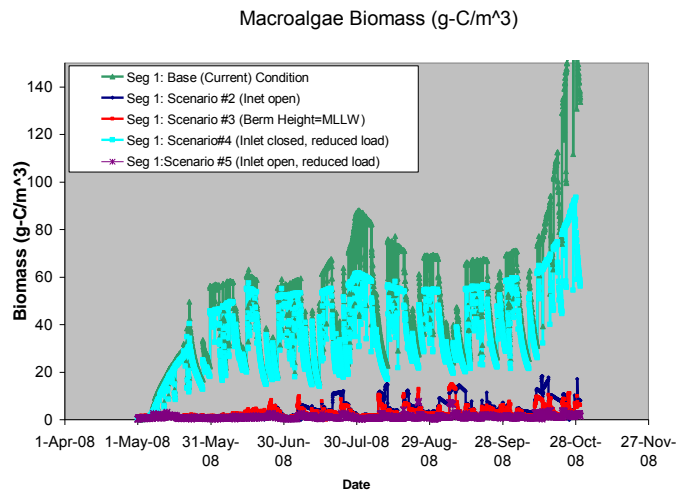
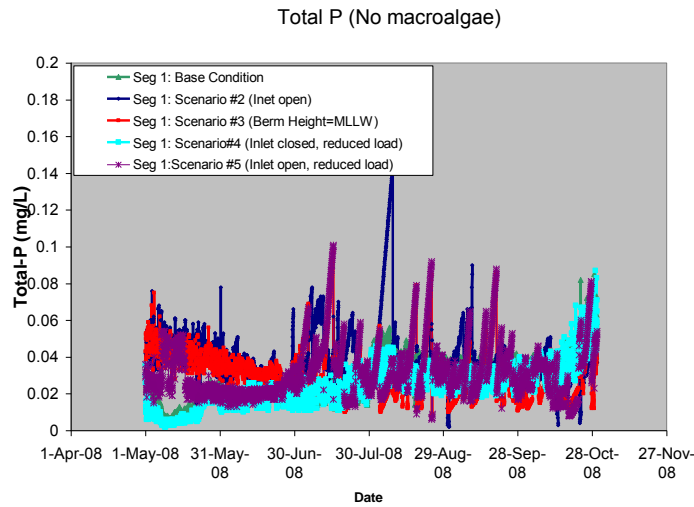
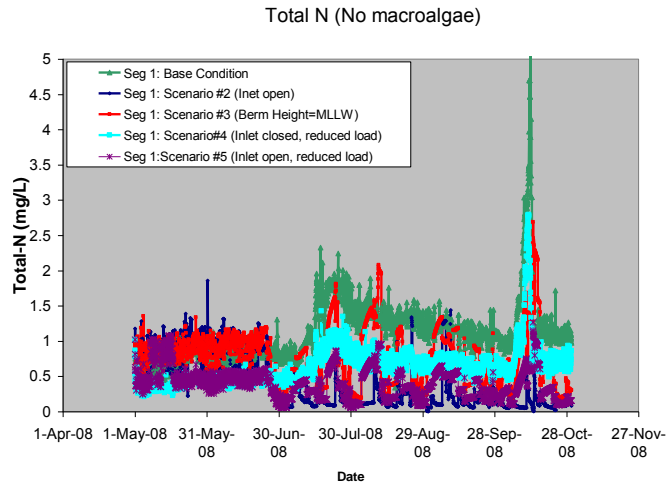
### *6.4.4 Summary of Implementation Scenario Analysis For Bacteria and Nutrients*

In summary, the implementation scenario analysis demonstrated:

- Current bacteria loads at ME exceed the FIB numeric target year round (365 days), with the largest number of exceedance days for enterococci , followed by fecal coliform and total coliform. The implementation scenarios analyzed illustrate that none of the scenarios would help the watershed achieve compliance with FIB numeric targets. Furthermore, operation of the Slough dewatering and UV treatment result in 16% reduction in the FIB concentrations in the Slough.
- For impairment from macroalgae, opening of the Slough or maintenance of the berm would the bring macroalgal biomass and nutrient concentration numeric targets. Load reduction alone would require a 93% reduction in dry weather flow in order to meet macroalgal biomass.



**Figure 6.16. Simulated total-N, total-P and macroalgae biomass at OI for inlet openness and load reduction scenarios(C/Chla ratio = 120).**



**Figure 6.17. Simulated total-N, total-P and macroalgae biomass at Segment 1 for inlet openness and load reduction scenarios (C/Chla ratio = 120).**

## 7 SUMMARY OF MODELING WORK AND RECOMMENDATIONS

### 7.1 Summary of Model Calibration and Validation

**Watershed Modeling.** Data compilation, analysis, and model calibration and validation were conducted to support development of a watershed loading model for the Loma Alta Slough watershed. The calibrated and verified hydrologic model was shown to be of predictive value, and capable of simulating hydrologic response based on land use and land cover, soils, and percent slope, and that capability is valid insofar as the SDHM model (which is well accepted by the hydrologic model practice community) is representative of the real world system.

For the Loma Alta Slough watershed model, simulation of the indicator bacteria enterococcus, fecal coliform, and total coliform was established by calibrating against the daily loading data listed in Appendix D-3 of the 2009 CHU Lagoon Monitoring Report prepared by Mactec. Fits obtained indicated that all three bacteria loading models are predictive. In retrospect, log transformation of the loading data that was used for model calibration, and their model simulated counterparts, prior to objective function calculation, could be an avenue to pursue in attempts to ensure that the model is not biased towards over-fitting the higher loading values at the expense of the lower daily bacteria loading values.

**Estuary Hydrodynamic Model.** Simulation of water surface elevation, salinity and temperature illustrate that the hydrodynamic model is working well during wet weather, winter dry weather (when the mouth is open) and summer dry weather (when the Slough mouth is closed). Measured versus observed WSE showed a model fit of  $R = 0.96$ , with a slope of 1.003, indicating less than 1% error. The good performance of the hydrodynamic model provides us with a measure of confidence to use the model for water quality applications.

Uncertainty in dry weather flows from the watershed is a source of uncertainty. This uncertainty was partially addressed with additional monitoring conducted in 2010. Utilization of 2010 data in the calibration of 2008 hydrology and water quality results introduces additional uncertainty in water quality model runs for bacteria and nutrients.

Berm height is variable in the Slough, arising from the combination of natural forcing of freshwater flow versus. Our solution to choose fix berm heights representative of the calibration and validation periods is an acceptable solution to a modeling problem, but the lack of data on the average berm height over periods of years, particularly during wet weather and winter dry weather is a source of uncertainty to results. Exchange of the Slough water with the ocean through the sand berm and with groundwater is also another source of uncertainty in the modeling. Using existing data, we were able to achieve good model validation. However, the net effect of ocean and groundwater exchange on the Slough water quality (FIB and nutrients) has not been quantified.



**Slough Bacteria Modeling.** Simulation of bacteria during wet weather and dry weather illustrate that: 1) the FIB water quality model is performing adequately during wet and dry weather conditions and 2) watershed loads explain the majority of the measured variability in Slough FIB bacteria. During wet weather, Slough FIB concentrations closely approximated that of the MES, but approximately 33% of grabs over 3 storms were outside of modeled range, indicating that an additional bacteria sources may exist near within the lower Creek or within the Slough. A similar result was found during dry weather, particularly within the ocean inlet station. Therefore, more future work is needed to better identify and quantify this “additional source”.

Uncertainties in bacteria simulation modeling come from two major factors. First, the frequency of wet (3 storms) and dry weather (4 index periods) FIB load monitoring was low. The use of either modeling results or empirical data as boundary conditions to the Slough modeling study introduces uncertainty because bacteria concentrations are known to be highly variable over time, either as a function of storm event or during dry weather conditions. The second source of uncertainty arises from the indication that, while the MES loading explains the majority of variability in Slough FIB concentrations, there appears to be an additional source to the Slough. This will likely cause the model to underpredict the number of exceedance days relative to TMDL numeric targets.

**Slough Eutrophication Modeling.** Eutrophication for Loma Alta Slough was studied by the use of the linked EFDC+WASP model. While we were able to simulate the entire year of Nov 2007-Oct 2008, model results were presented and analyzed only for May-Oct 2008 when the inlet was closed and the water was most eutrophic. This was identified by the Regional Board and stakeholders as the critical condition.

Overall, the model performed well for simulation of macroalgae and nutrient concentrations. Macroalgae simulations had high accuracy (+/- 3%), while nutrient concentrations were underpredicted by 30%. Model results show that macroalgae growth during the period was limited by light throughout the simulation period, followed by limitation of phosphorus.

Dissolved oxygen was simulated and compared with measurements. Simulated DO and measured DO near the bottom were compared for both OI and Segment 1 for most of the May-Oct 2008 period. During this period, the model did not capture the mean nor the diurnal variability of measured bottom water data. Modeled DO concentrations were persistently higher than measured values.

Additional data on DO and BOD loading were collected at the headwaters of the Slough during 2012 to discern whether the chronic hypoxia in the Slough was due to the higher BOD load and lower DO at the headwaters versus the mass emission station. Comparison of measured 2008 at the MES versus 2012 data at the head of the estuary illustrates that the DO loading between these stations was comparable and the BOD was actually lower at the headwaters.

Additional sensitivity analysis conducted on SOD illustrated that chronic hypoxia could be simulated with very high SOD ( $4.5 \text{ g m}^{-2} \text{ d}^{-1}$ ) in Loma Alta Slough. These rates do not compare with measured values in the Slough, although McLaughlin et al. (2011) note that there is considerable uncertainty in the measured values.

In conclusion, it may be possible that SOD this is the source of the discrepancy between measured and modeled values in 2008. Alternatively, there may be some other within-Slough source of oxygen demand that is driving down bottom water DO. Regardless, based on the new head-of-estuary DO and BOD values, it is clear that the watershed only contributes to the daily DO fluctuations in the Slough but is not responsible for the chronic hypoxia that was measured in the Slough.

## 7.2 Use of the Model to Facilitate Discussion on the Nutrient and Bacteria TMDL

The watershed loading and Slough hydrodynamic and water quality models were used to support decision-making on the nutrient and bacteria TMDL. The model was used in four types of applications:

- Calculation of numeric targets
- Calculation of total maximum daily loads
- Calculation of land-used based sources of bacteria and nutrients
- Analysis of implementation scenarios to meet TMDL numeric targets

**Calculation of Numeric Targets.** For bacteria, stakeholders and regulatory staff achieved consensus on how to use model output to calculate the bacteria TMDL numeric targets, using the bacteria TMDL I numeric targets.

For nutrients, model simulations showed that DO was insensitive to nutrient loads, so discussion focused on comparison of the existing biostimulatory objectives (i.e. TN and TP objectives) versus the alternative NNE indicator -- macroalgae. The stakeholders and regulatory staff used a summary of existing literature used to come to consensus on a numeric target and how to use the model output to calculate the numeric target.

**Calculation of TMDLs.** FIB. For dry weather, assuming a 0% allowable exceedance frequency, a diversion of 99.5 % of the freshwater flow from Loma Alta Creek would be required to meet the enterococcus numeric target (Table 6.5). For coliform standards, the range of flow reduction ranged from 97% for fecal coliform to 85% for total coliform. For wet weather, a 99.9% load reduction would be required to meet the enterococcus single grab standard in the Slough. A 97% reduction would be required to meet the fecal coliform standard, while an 80% reduction would be required to meet the total coliform standard.

Nutrients and Macroalgae. A 81-96% reduction in TP and TN loads to the Slough during May –October are required to meet the agreed upon macroalgae numeric targets. Stakeholders and regulatory staff discussed how these targets should be met and specified that compliance should be met at both the upstream (Segment 1) and downstream (Segment 2) section of the Slough. However, the eutrophication model does not capture the drifting and spatial redistribution of algae. Therefore, we recommend that the Slough wide average be used to calculate the %load reduction required. Steep declines in the biomass are achieved with load reduction up to approximately 75%. After that, declines are more gradual.

For nutrient concentration-based numeric targets, the load reduction is required to meet TN concentration targets (3-15% for TN = 1 mg L<sup>-1</sup> and 46-57% for TN = 0.5 mg L<sup>-1</sup>) was substantially less than that required to meet a macroalgal numeric target. No reduction in TP loads would be required to meet TP numeric targets, regardless of the interpretation of the Basin Plan Biostimulatory Objective; this is problematic, recognizing that the Slough is P-limited for during the May-October critical period (McLaughlin et al. 2011).

**Implementation Scenario Analysis.** The implementation scenario analysis demonstrated:

- Current bacteria loads at ME exceed the FIB numeric target year round (365 days), with the largest number of exceedance days for enterococci, followed by fecal coliform and total coliform. The implementation scenarios analyzed illustrate that none of the scenarios would help the watershed achieve compliance with FIB numeric targets. Furthermore, operation of the Slough dewatering and UV treatment result in 16% reduction in the FIB concentrations in the Slough.
- For impairment from macroalgae, opening of the Slough or maintenance of the berm would bring macroalgal biomass and nutrient concentration numeric targets. Load reduction alone would require up to a 96% reduction in dry weather flow in order to meet macroalgal biomass numeric targets.

## 8 REFERENCES

- Ackerman, D. and K. Schiff. 2003. Modeling Storm Water Mass Emissions to the Southern California Bight. *Journal of Environmental Engineering*, Vol. 129, No. 4, p. 308-217.
- Biggs B.J. F. 2000. Eutrophication of streams and rivers: Dissolved nutrient- chlorophyll relationships for periphyton. *J. North Am. Benthol. Soc.* 19: 17–31.
- Bona, F. 2006. Effect of seaweed proliferation on benthic habitat quality assessed by Sediment Profile Imaging. *Journal of Marine Systems* 62:142-151.
- Cardoso, P. G., M. A. Pardal, D. Raffaelli, A. Baeta, and J. C. Marques. 2004. Macroinvertebrate response to different species of macroalgal mats and the role of disturbance history. *Journal of Experimental Marine Biology and Ecology* 308:207-220.
- Chetelat, J., F. Pick, et al. 1999. Periphyton biomass and community composition in rivers of different nutrient status. *Canadian Journal of Fisheries and Aquatic Sciences* 56:560-569.
- Cloern, J.E. 2001. Our evolving conceptual model of the coastal eutrophication problem. *Marine Ecology Progress Series*. 210:223–253.
- Green, L. 2011. Effects of macroalgae on the benthic infauna on estuarine intertidal flats and implications for the foraging behavior of estuarine migratory birds. Ph.D. Dissertation, University of California, Los Angeles. Los Angeles, CA
- Kennison, R., K. Kamer, et al. 2003. Nutrient dynamics and macroalgal blooms: A comparison of five southern California estuaries. Southern California Coastal Water Research Project. Westminster, CA.
- Mactec Engineering and Consulting Inc., 2009. Carlsbad Hydrological Unit (CHU) Lagoon Monitoring Report, Mactec Technical Report.
- McLaughlin, M Sutula, J Cable, P Fong. Eutrophication and Nutrient Cycling in Loma Alta Slough, Oceanside, California. 2011. K Technical Report 630. Southern California Coastal Water Research Project. Costa Mesa, CA. [www.sccwrp.org](http://www.sccwrp.org)
- McLaughlin K., M. Sutula, L. Busse, S. Anderson, J. Crooks, R. Dagit, D. Gibson, K. Johnston, L. Stratton. (in press) A Regional Survey of Extent and Magnitude of Eutrophication in Southern California Estuaries. *Estuaries and Coasts*.
- Merkel & Associates, Inc. 2010. San Francisco Bay Eelgrass Inventory October – November 2009. Report for: San Francisco-Oakland Bay Bridge East Span Seismic Safety Project.
- Nixon, S.W. 1995. Coastal marine eutrophication: A definition, social causes, and future concerns. *Ophelia* 41:199-219.
- Scanlan, C. M., J. Foden, E. Wells, and M. A. Best. 2007. The monitoring of opportunistic macroalgal blooms for the water framework directive. *Marine Pollution Bulletin* 55:162-171.

Sengupta, A., Martha A. Sutula, Karen McLaughlin, Meredith Howard, Liesl Tiefenthaler. In prep. Riverine Nutrient Loads and Fluxes to the Southern California Bight. In prep

Sutula, M. 2011. Review of candidate indicators for development of nutrient numeric endpoints in California estuaries. Technical Report 646. Southern California Coastal Water Research Project. Costa Mesa, CA.

Sutula M., H. Bailey, S. Poucher. 2012. A review of science supporting dissolved oxygen objectives in California estuaries. Technical Report 684. Southern California Coastal Water Research Project. Costa Mesa, CA. [www.sccwrp.org](http://www.sccwrp.org)

Sutula M., L. Green, G. Cichetti, N. Detenbeck, and P. Fong. In press. Thresholds of Adverse Effects of Macroalgal Abundance and Sediment Organic Matter on Benthic Habitat Quality in Estuarine Intertidal Flats. Estuaries and Coasts.

TetraTech. 2006. Technical Approach to Develop Nutrient Numeric Endpoints for California. Tetra Tech, INC. Lafayette, CA.

Zaldivar, J.-M., A. C. Cardoso, et al. (2008). "Eutrophication in transitional waters: an overview." Transitional Waters Monographs 1: 1-78.

