

CALIFORNIA REGIONAL WATER QUALITY CONTROL BOARD
CENTRAL VALLEY REGION

Fresno Office
1685 "E" Street
Fresno, CA 93706-2007

Sacramento Office (Main)
11020 Sun Center Drive #200
Rancho Cordova, CA 95670-6114

Redding Office
364 Knollcrest Drive #205
Redding, CA 96002

[Regional Board Website](https://www.waterboards.ca.gov/centralvalley) (https://www.waterboards.ca.gov/centralvalley)

[TENTATIVE] WASTE DISCHARGE REQUIREMENTS ORDER
R5-20XX-XXXX



ORDER INFORMATION

Order Type(s):	Waste Discharge Requirements (WDRs)
Status:	TENTATIVE
Program:	Title 27 Discharges to Land
Region 5 Office:	Sacramento (Rancho Cordova)
Discharger(s):	Waste Management of Alameda County, Inc.
Facility:	Altamont Solidification Facility
Address:	10840 Altamont Pass Road
County:	Alameda County
Parcel Nos.:	99B-6275-1-1
GeoTracker ID:	L10005834311
Place ID:	888337
WDID:	5B01TI00001
Prior Order(s):	None

CERTIFICATION

I, PATRICK PULUPA, Executive Officer, hereby certify that the following is a full, true, and correct copy of the order adopted by the California Regional Water Quality Control Board, Central Valley Region, on _____ April 2024.

PATRICK PULUPA,
Executive Officer

REGIONAL BOARD INFORMATION

Sacramento Office (Main)

Rancho Cordova, CA 95670-6114
11020 Sun Center Drive #200
Telephone: (916) 464-3291

Fresno Office

1685 "E" Street
Fresno, CA 93706-2007
Telephone: (559) 445-5116

Redding Office

364 Knollcrest Drive #205
Redding, CA 96002
Telephone: (530) 224-4845

[Regional Board Website](https://www.waterboards.ca.gov/centralvalley)

(<https://www.waterboards.ca.gov/centralvalley>)

TABLE OF CONTENTS

TABLE INDEX	iv
GLOSSARY	v
FINDINGS	1
Introduction	1
Materials Accompanying Order	2
Facility	3
Waste Classification & Permitting	4
Surface Impoundments	6
Waste Piles	7
Waste Characterization	8
Treated Auto Shredder Waste	9
Site Conditions	12
Monitoring Networks	15
Water Quality Protection Standard	20
Unit Construction	21
Unit Closures	29
Post-Closure Maintenance & Financial Assurances	29
California Environmental Quality Act	30
Other Regulatory Matters	31
Reporting Requirements	32
Procedural Matters	32
REQUIREMENTS	34

A. Discharge Prohibitions	34
B. Discharge Specifications	34
C. Facility Specifications	37
D. Unit Construction Specifications.....	40
E. Closure Specifications.....	45
F. Financial Assurances	46
G. Monitoring Requirements	47
H. Reporting Requirements	49
I. Time Schedule	50
J. Other Provisions.....	51
ATTACHMENT A—SITE LOCATION MAP	54
ATTACHMENT B—SOLIDIFICATION BASIN AREA.....	55
ATTACHMENT C—SOLIDIFICATION FACILITY PROPOSED FINAL GRADE	56
ATTACHMENT D—DOCUMENTED GEOLOGIC FEATURES.....	57
ATTACHMENT E—FAULT ZONE MAP	58
ATTACHMENT F—PROPOSED BASIN CROSS SECTIONS	59
ATTACHMENT G—PROPOSED ACCESS RAMP CROSS SECTION	60
ATTACHMENT H—PROPOSED LCRS AND PAN LYSIMETER	61
ATTACHMENT I—LEACHATE STORAGE TANKS.....	62
ATTACHMENT J—PROPOSED EXTENDER STOCKPILE AND WORK AREA DETAILS	63
ATTACHMENT K—1996 EIR PROJECT AREA	64
STANDARD PROVISIONS & REPORTING REQUIREMENTS	65
A. Applicability	65

B. Terms and Conditions	66
C. Standard Prohibitions	67
D. Standard Discharge Specifications	68
E. Standard Facility Specifications	69
F. Standard Construction Specifications	71
G. Standard Closure and Post-Closure Specifications.....	76
H. Standard Financial Assurance Provisions	80
I. Standard Monitoring Specifications	80
J. Response to Release	91
K. General Provisions.....	93
L. Storm Water Provisions.....	96
INFORMATION SHEET	99
Proposed Waste Management Units	99
California Environmental Quality Act	100
Facility Design Review & Authorization	101

TABLE INDEX

Table 1—Summary of Waste Management Units (WMUs) Permitted under Order..... 2

Table 2—Seismic Analysis..... 14

Table 3—Groundwater Monitoring Well Network 19

Table 4—Unsaturated Zone Monitoring Network 19

Table 5—Authorized Waste Discharges at Facility 35

Table 6—Time Schedule 50

GLOSSARY

ADC	Alternative Daily Cover
ALRRF	Altamont Landfill and Resource & Recovery Facility
Antidegradation Policy	Statement of Policy with Respect to Maintaining High Quality Waters in California, State Water Board Resolution 68-16
Basin Plan	<i>Water Quality Control Plan for the Sacramento and San Joaquin River Basins</i>
bgs	Below Ground Surface
btoc	Below Top of Casing
CalRecycle	California Department of Resources Recycling and Recovery
CAMP	Corrective Action Monitoring Program
CEQA	California Environmental Quality Act
C.F.R.	Code of Federal Regulations
COCs	Constituents of Concern
CQA	Construction Quality Assurance
Designated Waste	(a) Hazardous Waste subject to variance from management requirements per Health and Safety Code section 25143; and (b) Nonhazardous Waste containing pollutants that, under ambient conditions, could be released in concentrations exceeding applicable WQOs, or that could reasonably be expected to affect beneficial uses of water. (Wat. Code, § 13173.)
DTSC	California Department of Toxic Substances Control
EC	Electrical Conductivity
EIR	Environmental Impact Report
FEMA	Federal Emergency Management Agency
GCL	Geosynthetic Clay Liner

Hazardous Waste	Wastes which, pursuant to Title 22, § 66261.3 et seq., are required to be managed in accordance with Division 4.5 of Title 22. (Title 27, § 20164; Title 23, § 2521(a).)
JTD	Joint Technical Document
LCRS	Leachate Collection and Removal System
LEA	Local Enforcement Agency
Leachate	Liquid formed by the drainage of liquids from waste or by the percolation or flow of liquid through waste. Leachate includes any constituents extracted from the waste and dissolved or suspended in the fluid. (Title 27, § 20164.)
MCE	Maximum Credible Earthquake
MDL	Method Detection Limit
MIL	Millimeter
MSL	Mean Sea Level
MRP	Monitoring and Reporting Program
MSW	Municipal Solid Waste regulated under 40 C.F.R. part 258
MW	Monitoring Well
NTS	Not To Scale
RCRA	Resource Conservation and Recovery Act
ROWD	Report of Waste Discharge
SF	Square Feet
SPRRs	Standard Provisions and Reporting Requirements
Subtitle D	USEPA-promulgated MSW regulations under RCRA (see 40 C.F.R. part 258)
Status	The relative regulatory condition of a waste management unit with respect to Title 27 section 20005 et seq.

SY	Square Yard
TASW	Treated Auto Shredder Waste
TBD	To Be Determined
Title 22	California Code of Regulations, Title 22
Title 23	California Code of Regulations, Title 23
Title 27	California Code of Regulations, Title 27
Type	Waste Management Unit Type, Title 27 § 20950(c)
USEPA	United States Environmental Protection Agency
WDRs	Waste Discharge Requirements
WMU	Waste Management Unit or “Unit”
WQOs	Water Quality Objectives
WQPS	Water Quality Protection Standard

FINDINGS

The Central Valley Regional Water Quality Control Board (Central Valley Water Board) hereby finds as follows:

Introduction

1. Waste Management of Alameda County, Inc. (Discharger) proposes construction of a new Altamont Solidification Facility (Facility), which the Discharger intends to own and operate at the Altamont Landfill Resource Recovery Facility (ALRRF) approximately 3.5 miles east of the City of Livermore's eastern boundary in Alameda County, Section 15, Township 2 South, Range 3 East, Mount Diablo Base and Meridian. The proposed Facility's location is depicted on the Site Location Map in **Attachment A**.
2. The proposed Facility is related to the ALRRF, which is also owned and operated by the Discharger. The ALRRF is a large active municipal solid waste (MSW) landfill and compost facility with an extensive history of waste discharge requirement updates, revisions, and is subject to ongoing enforcement. Active Orders for the ALRRF include the following:
 - a. Waste Discharge Requirements (WDRs) Order R5-2016-0042-01, as amended by WDRs Order R5-2017-0026, for the ALRRF;
 - b. Cease and Desist Order (CDO) R5-2021-0020, in part, establishes a time schedule for the Discharger to resolve multiple compliance issues, including requirements relating to an existing solidification basin facility at the ALRRF in Fill Area 1. CDO R5-2021-0020 requires the Discharger to "...submit a Report of Waste Discharge to install off waste liquid solidification basins completed as Class II liquid waste management units." The Discharger submitted a Report of Waste Discharge (ROWD) in response to this requirement; and
 - c. Coverage under State Water Resources Control Board Order 2015-0121-DWQ-R5S008 for an ALRRF onsite composting operation.
3. These WDRs regulate the Altamont Solidification Facility and do not regulate ALRRF facilities or activities described in Finding 2.
4. The proposed Facility is situated on less than 0.5-acres on the ALRRF property and is associated with Assessor's Parcel Numbers (APNs) 99B-6275-1-1. The address associated with the Facility is 10840 Altamont Pass Road, Livermore, California 94551.

5. As the Facility's owner and operator, the Discharger is responsible for compliance with this Order, which prescribes WDRs regulating construction, monitoring, operation, closure, and post-closure maintenance of the Waste Management Units (WMUs) listed in **Table 1**.

**Table 1—Summary of Waste Management Units (WMUs)
Permitted under Order**

Unit	Type	Class	Size	Status
Yellow Flag Basin	Surface Impoundment	Class II	14,000 SF	Planned
Blue Flag Basin	Surface Impoundment	Class II	2,800 SF	Planned
Extender Stockpile and Work Area	Waste Pile	Class II	~52,000 SF	Planned

See Glossary for definitions of terms and abbreviations in table.

Materials Accompanying Order

6. The following materials are attached to this Order, and incorporated herein:

ATTACHMENT A—SITE LOCATION MAP
ATTACHMENT B—SOLIDIFICATION BASIN AREA
ATTACHMENT C—SOLIDIFICATION FACILITY PROPOSED FINAL GRADE
ATTACHMENT D—DOCUMENTED GEOLOGIC FEATURES
ATTACHMENT E—FAULT ZONE MAP
ATTACHMENT F—PROPOSED BASIN CROSS SECTIONS
ATTACHMENT G—PROPOSED ACCESS RAMP CROSS SECTION
ATTACHMENT H—PROPOSED LCRS AND PAN LYSIMETER
ATTACHMENT I—LEACHATE STORAGE TANKS
ATTACHMENT J—PROPOSED EXTENDER STOCKPILE AND WORK AREA DETAILS
ATTACHMENT K—1996 EIR PROJECT AREA

Standard Provisions & Reporting Requirements for Non-Hazardous Discharges of Waste Regulated under Subtitle D and/or Title 27, December 2015 Edition (SPRRs or Standard Provisions)

Information Sheet for [TENTATIVE] Waste Discharge Requirements Order
(Information Sheet)

7. This Order is also accompanied by the concurrently adopted **Monitoring & Reporting Program R5-20XX-XXXX (MRP)**, the provisions of which are incorporated as part of this Order. Each time the operative MRP is modified by the Central Valley Water Board or its Executive Officer, the revised version shall become the operative MRP (superseding the prior version) and be incorporated as part of this Order (i.e., in lieu of the prior version).
8. To the extent there are any material inconsistencies between the provisions of this Order, the operative MRP, and the SPRRs, the provisions of this Order shall be controlling. However, to the extent a revised MRP contains new or different factual findings reflecting changed conditions or circumstances at the Facility, the revised MRP findings shall be controlling.
9. Additional information about the proposed Facility is set forth in the **Information Sheet**, which is incorporated as part of these findings. (See Finding 6)

Facility

10. On 19 October 2021, the Discharger submitted a Design Report for the proposed solidification basins as a ROWD in response to the CDO No. R5-2021-0020, Directive 17 requirement for the Discharger to "...submit a Report of Waste Discharge to install [ALRRF] off waste liquid solidification basins completed as Class II liquid waste management units."
11. On 30 June 2022, the Discharger submitted Revision 1 to the ROWD, which includes revisions to construction drawings, technical specifications, and the construction quality assurance plan described in the 19 October 2021 ROWD.
12. On 1 July 2022, the Discharger submitted an Operation and Maintenance Plan for the proposed Solidification Facility.
13. On 8 November 2022, the Discharger proposed a monitoring and reporting plan for the Solidification Facility.
14. On 8 May 2023, the Discharger submitted a cost estimate for clean closure of the Facility.
15. On 17 May 2023, the Discharger submitted a complete, signed application for WDRs, referred to as a "State Form 200."

16. On 9 July 2023 the Discharger submitted Revision 2 to the ROWD, which includes revisions to construction drawings, technical specifications, and the construction quality assurance plan described in the 19 October 2021.
17. The Discharger's submissions described in Finding Nos. 10, 11, 12, 13, 14, 15 and 16, are hereinafter collectively referred to as the ROWD for the proposed Facility. Information in the ROWD was used in the development of this Order.
18. The ROWD is deemed complete upon Central Valley Water Board authorization of Final Construction Details pursuant to Unit Construction Specification D.8.
19. The proposed solidification basins' purpose and function is to solidify liquid wastes with various solid wastes (described as "extenders") in concrete lined basins constructed as Class II surface impoundments with an adjacent stockpile area. The Discharger's ROWD includes information relating to the following onsite features, systems, and structures for the Solidification Facility:
 - a. "Yellow Flag" basin, 100 feet wide, 140 feet long, and 12 feet deep, designed to hold 350 tons of liquid wastes;
 - b. "Blue Flag" basin, 20 feet wide, 140 feet long, and 12 feet deep, designed to hold 70 tons of liquid wastes;
 - c. Extender Stockpile and Work Area, approximately 52,000 square feet for storage for extender materials and access for equipment, and trucks hauling TASW;
 - d. A 15,000-gallon, dual contained above-ground leachate storage tank located north of the basins; and
 - e. A 500-gallon dual contained above-ground leachate storage tank located north of the basins.

Waste Classification & Permitting

20. Surface impoundments and waste pile areas are regulated under authority given in Water Code section 13000 et seq. and California Code of Regulations, title 27 (Title 27), section 20005 et seq.
21. A "surface impoundment" is a WMU which is a natural topographic depression, excavation, or diked area, which is designed to contain liquid wastes or wastes containing free liquids, and which is not an injection well (Title 27, § 20164). Title 27 identifies the placement of designated liquids (including un-dewatered sludges) in surface impoundments as an authorized waste management strategy for discharges to land (Title 27, § 20120, Table 2.1).

22. Water Code section 13173 defines “Designated Waste” as either of the following:
 - a. Hazardous waste that has been granted a variance from hazardous waste management requirements pursuant to Health and Safety Code section 25143.
 - b. Nonhazardous waste that consists of, or contains, pollutants that, under ambient environmental conditions at a WMU, could be released in concentrations exceeding applicable water quality objectives or that could reasonably be expected to affect beneficial uses of the waters of the state as contained in the appropriate state water quality control plan.
23. Designated waste can be discharged only at Class I WMUs, or at Class II WMUs that comply with Title 27 and have been approved by the Central Valley Water Board for containment of the particular waste to be discharged.
24. A “waste pile” is a WMU at which only noncontainerized, bulk, dry solid waste is discharged and piled for treatment or storage on an engineered liner system that prevents the waste from contacting the underlying land surface. The term does not include a WMU of similar construction that is used for waste disposal (Title 27, § 20164).
25. All new surface impoundments and waste piles are required to be sited, designed, constructed, and operated to ensure that wastes will be a minimum of five feet (5 ft.) above the highest anticipated elevation of underlying ground water (Title 27, § 20240(c)).
26. All engineered structures (including, but not limited to, containment structures) constituting any portion of a WMU shall have a foundation or base capable of providing support for the structures and withstanding hydraulic pressure gradients to prevent failure due to settlement, compression, or uplift, as well as all effects of ground motions resulting from at least the maximum probable earthquake [for Class III Units (see Title 27, § 20370)] or the maximum credible earthquake [for Class II Units (*Ibid.*)], as certified by a registered civil engineer or certified engineering geologist. (Title 27, §§ 20240(d), 21750(f)(5).)
27. Waste piles and surface impoundments shall be fitted with subsurface barriers (see Title 27, § 20360) as needed and feasible, and shall have precipitation and drainage control facilities as described in Title 27 section 20365. (Title 27 § 20310.)
28. All waste piles and surface impoundments shall comply with the seismic design criteria in Title 27 section 20370 (Title 27, § 20310).

Surface Impoundments

29. Title 27 requires full containment of liquid designated wastes in Class II surface impoundment WMUs that are double lined, include a leachate collection and removal system (LCRS), and which comply with applicable siting and geologic conditions. (Title 27, § 20210.)
30. The Title 27 performance standard for Class II surface impoundments requires full containment of liquid wastes (Title 27, §§ 20310(a), 20330(a)). Liquid wastes must also be compatible with containment features of the Class II surface impoundment and other wastes contained therein. (Title 27, §§ 20200(c), 20320 (e)). The Discharger employs a rigorous process to characterize waste before it accepts the waste for discharge into the solidification basins. While unauthorized discharges from the Class II surface impoundment are neither anticipated nor allowed (Title 27, 20375(d)) by these WDRs, unintentional release of wastes from waste management units remains possible for any Class II surface impoundment. As such, characterization of wastes contained in the Class II surface impoundments is appropriate to 1.) assess the compatibility of wastes with containment features of the new Class II surface impoundments; and 2.) address unauthorized release scenarios. Characterization of wastes contained in the Class II surface impoundments also supports differentiation between a potential release attributed to a waste management unit at the proposed Facility from a potential release from the adjacent ALRRF or other sources and supports early, appropriate, and efficient implementation of corrective action if necessary.
31. Surface impoundments shall be fitted with liners and LCRS, as described in Title 27, sections 20330 and 20340, as feasible (Title 27, § 20310).
32. Surface impoundments shall have sufficient freeboard to accommodate seasonal precipitation and the design storm specified in Table 4.1 of Title 27, division 2, subdivision 1, chapter 3, subchapter 2, article 4, but in no case less than two (2) feet (measured vertically, from the water surface up to the point on the surrounding lined berm, or dike, having the lowest elevation), and shall be designed and constructed to prevent overtopping as a result of wind conditions likely to accompany such precipitation conditions (Title 27, § 20375(a)). For the proposed configuration of the surface impoundments, the “surrounding lined berm” shall be interpreted as the elevation of the extent of the highest elevation of the leak detection system behind the basin and access ramp vertical walls (see Finding 95).
33. Title 27 requires the Discharger to prepare and submit an operations plan to the Central Valley Water Board which provides operation levels and waste input quantities permitted each month based on anticipated precipitation and on past

precipitation conditions for the year (Title 27, § 20375(b)). These WDRs require the Discharger to prepare and submit an annual Operations Plan for the Facility.

34. All visible portions of synthetic liners shall be inspected weekly until all free liquid is removed from the surface impoundment as part of closure pursuant to Title 27 section 21400(a). If, during the active life of the impoundment, the wastes are removed and the bottom of the impoundment is cleaned down to the liner, an inspection shall be made of the bottom of the liner prior to refilling of the impoundment (Title 27, § 20375(f)).

Waste Piles

35. Title 27 prohibits the discharge of wastes containing free liquids to a Class II waste pile. Any waste that contains liquid in excess of the moisture-holding capacity of the waste in a waste pile as a result of waste management operations, compaction, or settlement shall only be discharged to a surface impoundment or to another WMU with containment features equivalent to a surface impoundment (Title 27, § 20200(d)).
36. New and existing waste piles shall be immediately underlain by natural geologic materials which have a hydraulic conductivity of not more than 1×10^{-6} cm/sec (i.e., 1 foot/year) and which are of sufficient thickness to prevent vertical movement of fluid, including waste and leachate, from WMU to waters of the state for as long as wastes in such units pose a threat to water quality. Waste piles shall not be located where areas of primary (porous) or secondary (rock opening) hydraulic conductivity greater than 1×10^{-6} cm/sec (i.e., 1 foot/year) could impair the competence of natural geologic materials to act as a barrier to vertical fluid movement. A liner system which conforms to the requirements of Title 27 with a hydraulic conductivity of not more than 1×10^{-6} cm/sec (i.e., 1 foot/year) shall be used for waste piles when natural geologic materials do not satisfy the geological setting requirements of Title 27 (Title 27, § 20250(b)).
37. Waste piles which contain only dry wastes (not including nonhazardous solid waste and decomposable waste) may be allowed to operate without an LCRS if the Discharger demonstrates, based on climatic and hydrogeologic conditions, that leachate will not be formed in, or migrate from, the Unit (Title 27 § 20340(a)).
38. Title 27 authorizes the Central Valley Water Board to require the Discharger to utilize an interim cover on waste piles that meets the standards set forth in Title 27 section 20705. (Title 27, §§ 20310, 20705).

Waste Characterization

39. The ROWD does not include quantitative characterizations of wastes relating to the proposed solidification operation. The following is a summary of the qualitative description of the proposed solidification wastes:

- a. Liquid Wastes: The ROWD describes the liquids accepted at the proposed Facility as “non-hazardous” and “profiled to be non-reactive, non-corrosive, non-toxic, and non-ignitable.” The Discharger represents that it accepts non-hazardous liquid wastes such as car and truck wash sludge, grease trap wastes, monitoring well purge water, tank rinse water, food wastes, commercial, industrial, and residential waste waters, sludges, and other high moisture content wastes. Estimated annual historical liquid waste quantities solidified range from 1.1 to 8.9 million gallons. The Discharger also proposes to use the solidification basins to collect washout station wash water and operational surface water. The distinction between “Blue Flag” and “Yellow Flag” wastes is an operational determination made by the Discharger. The Discharger’s Standard Operating Procedures for the existing solidification basins describe the Discharger’s waste categorization procedures as follows:

When a customer with non-hazardous liquid waste weighs in at the scale house, they are issued either a blue or yellow flag by the scale house attendant based on the material’s profile description. After the customer checks in, the scale house attendant places a radio call to the landfill traffic controller who spots (directs) the customer to offload at the appropriate pit. In addition to the flag procedure, the pits themselves are designated by large signs that say “Blue Flag” and “Yellow Flag” so customers can easily determine the pit they are to offload their material in based on the colored flag they received.

The Discharger’s Standard Operating Procedures further describe the following “waste acceptance protocol”:

A Waste Approvals Manager (WAM) employed by Waste Management determines if a liquid waste may be received at the facility based upon the generator’s profile information, the current Waste Acceptance Criteria Plan for the facility, and applicable regulations.

- b. Extenders: Per the ROWD, examples of “extenders” proposed for storage and management at the Proposed Solidification Facility include soil, TASW, ash, cement kiln dust, processed construction and demolition debris material/screenings, ground wood waste, or a combination of these materials.

- c. Solidified Wastes: Once solidified, the Discharger uses “Yellow Flag” solidified wastes as Alternative Daily Cover (ADC) at the ALRRF. “Blue Flag” wastes do not meet the criteria for use as ADC because they are potentially odorous and therefore solidified “Blue Flag” wastes are disposed in the ALRRF. According to the ROWD, the Discharger estimates it uses approximately 80 percent of solidified liquid wastes as ADC at the ALRRF.

These WDRs require the Discharger to perform and report waste characterization of liquids stored in the Class II surface impoundments on an annual basis. The 1 July 2022, Operation and Maintenance Plan for the proposed Solidification Facility (See Finding 12) describes facility operations which result in itinerant wastes with limited residence times in the Class II surface impoundments. To balance the requirements in the Water Code and Title 27 with the planned operation of the proposed basins, these WDRs allow the Discharger to collect a composite sample liquid waste intended for discharge to each basin annually commencing within 60 days of the initial authorized discharge to the basins. Subsequent solidification basin sampling events would continue annually thereafter and may coincide with periods of planned basin inspection and maintenance.

40. The Discharger does not propose to discharge asbestos-containing waste (i.e., >1% asbestos) at the Facility.
41. The Discharger does not propose to discharge Treated Wood Waste, as defined in California Code of Regulations, title 22 (Title 22), section 67386.4, at the Facility. Treated Wood Waste may contain chemicals such as chromated copper arsenate (CCA), pentachlorophenol, creosote, acid copper chromate (ACC), ammoniacal copper arsenate (ACA), ammoniacal copper zinc arsenate (ACZA), or chromated zinc chloride (CZC).

Treated Auto Shredder Waste

42. In August 2021, the California Department of Toxic Substances Control (DTSC), published a report entitled *Evaluation and Analysis of Metal Shredding Facilities and Metal Shredder Wastes* (DTSC Report). The DTSC Report evaluated, among other things, disposal of treated auto shredder waste (TASW), a type of

Chemically Treated Metal Shredder Residue (CTMSR).¹ The DTSC Report defines CTMSR as:

Metal shredder residue that has been subject to a chemical stabilization treatment process consisting of the addition of sodium or potassium silicate and an alkaline cement powder to reduce to the solubility of metals in the residue.

(DTSC Report, p. 3.) The DTSC Report explains that although metal shredder waste generally constitutes hazardous waste under California law, disposal of CTMSR as nonhazardous waste in MSW landfills, including its use as alternative daily cover (ADC), has not resulted in harm to human health or safety or the environment. (*Id.*, pp. 8-9.) The DTSC Report further concludes that *the analysis demonstrated that CTMSR has not contributed to the solubilization and migration of heavy metals from solid waste landfills via leaching into soil or groundwater, surface water contamination or windborne dispersion.* (*Id.*, pp. 8-9.)

43. Pursuant to Title 22 section 66260.200, subdivision (f), any party seeking to classify and manage as nonhazardous a waste which would otherwise be a hazardous waste under California law may apply for DTSC approval of such declassification. Such written approval is generally referred to as an “f letter.” (DTSC Report, p. 9.)
44. The DTSC Report describes the following broad regulatory requirements for TASW:
 - a. TASW generators may accumulate hazardous waste onsite for up to 90 days without a permit only if the waste is appropriately contained. (DTSC Report, p. 42, citing Title 22, § 66262.34.)
 - b. The transportation of a hazardous waste is a regulated hazardous waste management activity and requires the use of a registered hazardous waste transporter. (*Id.*, p. 44.)
 - c. DTSC’s written approval of a generator’s application to classify and manage wastes as a non-hazardous waste that would otherwise be a non-RCRA hazardous waste pursuant to § 66260.200(f), (i.e., an “f letter”).

¹ In these WDRs, “Chemically Treated Metal Shredder Residue” or “CTMSR” and “Treated Auto Shredder Waste” or “TASW” have the same meaning.

45. Title 27 section 20690(b)(6) authorizes the use of TASW as ADC at MSW landfills provided that the following criteria are met:
 - a. Such use has been authorized in writing by the Local Enforcement Agency (LEA), with concurrence from CalRecycle;
 - b. The waste is treated pursuant to Title 22 section 66268.106(a)(1), which identifies non-RCRA² TASWs and the concentrations of their associated hazardous constituents which may not be exceeded by the extract of the waste or treatment residual for the allowable land disposal of such waste or residual; and
 - c. TASW used for ADC shall be restricted to a minimum compacted thickness of 6 inches and average compacted thickness of less than 24 inches.
46. According to the DTSC Report, the ALRRF received an annual average of 144,541 tons of TASW from 2017 to 2019. According to the joint technical document (JTD) for the ALRRF, as revised 30 April 2020, the Facility has a variance from DTSC to accept TASW for use as ADC in Fill Area 2.
47. CalRecycle considers TASW an approved ADC Material type. (See CalRecycle, *Daily/Intermediate Cover and Alternative Daily/Intermediate Cover Guidelines*, <https://calrecycle.ca.gov/swfacilities/permitting/guidance/dailyintcovr/>.)
48. The DTSC is developing updated regulations relating to TASW. The updated regulations, if promulgated, may provide for exclusion of TASW as a “hazardous waste” provided certain conditions are met. The DTSC does not propose repealing existing regulations relating to TASW.
49. These WDRs require the Discharger to use, store, and accumulate TASW at the Solidification Basin Facility in manner consistent with Title 22, Title 27, and all other statutes, regulations, and policies, including any applicable updated regulations administered by the DTSC.
50. The Discharger proposes to discharge certain **Designated Wastes** (see Wat. Code, § 13173)—specifically, non-hazardous liquid wastes described in Finding No. 39.a, ‘extenders’ including TASWs described in Finding No. 39.b, and

² Non-RCRA hazardous wastes are those wastes designated hazardous under California law, but not designated hazardous under applicable federal law (i.e., the Resources Conservation and Recovery Act (RCRA)). (Title 22, §§ 66261.100-66261.101.)

solidified wastes described in Finding No. 39.c —to Class II WMUs at the Facility. The Discharger further proposes to discharge all stormwater captured from the Extender Stockpile and Work Area described in Finding 19.c to Class II WMUs at the Facility. These WDRs authorize the discharge of such wastes to the WMUs specified in **Section B.1** and **Table 5**.

51. The Discharger proposes to discharge leachate extracted from the Yellow Flag and Blue Flag Basins to either the Yellow Flag or Blue Flag Basin depending on operational need rather than returning such waste to the same WMU from which it originated, as is ordinarily required. (See Title 27, § 20340.) The WMUs proposed to receive the leachate are proposed to have functioning LCRS capable of containing waste similar in classification and characteristics to the waste management units of origin. Further, these WDRs require the respective receiving WMUs to comply with Title 27 section 20200.

Site Conditions

52. The proposed Solidification Facility and ALRRF are near the crest of the Diablo Range in an area characterized by steep rolling hills (Altamont Hills). ALRRF elevations vary from a low of about 450 feet above mean sea level (MSL) in the southeast corner, to a high of 1,262 feet above MSL on the highest hill in the west portion of the existing Facility. The proposed Facility is approximately 800 feet above MSL and north of Fill Area 2, as depicted in **Attachment B**. The regional topography is characterized by moderately to steeply rolling hills and narrow valleys that have a northwest trend. Surface water flows from the ridges down through the valleys and discharges into local drainages. These natural drainages, which are often dry, ultimately drain toward the Sacramento-San Joaquin Delta to the east or the San Francisco Bay toward the west, when surface water flow is sufficient. The drainage divide between the Central Valley Region and San Francisco Bay Region traverses the ALRRF property.
53. The proposed Solidification Facility is on the east side of the ALRRF property, adjacent to ALRRF Fill Area 2, in a sparsely populated area and is within a land use area zoned as “A” District, primarily used for agricultural purposes (public utility and sanitary landfill uses are granted within this designation through the issuance of a conditional use permit) and where surface water flows drain toward the Sacramento-San Joaquin Delta to the east. Adjacent land uses within 1,000 feet of the facility include dry-land farming, cattle grazing, power-producing windmills, water storage and conservation.
54. According to the ROWD, the proposed solidification basins are adjacent to a ridgeline that previously supported wind turbines and an active conservation easement, as depicted in in **Attachment B** and **Attachment C**. The building pads for these turbines appear to have been primarily constructed by excavating

the ridge top to establish a level working pad. Some minor filling may have occurred along the edge of the pad along the outside edge of access roads.

55. In addition to storm water runoff, natural groundwater seepage contributes to the discharge from the Altamont Hills. The locations of formerly identified groundwater seeps in the vicinity of the ALRRF are shown on **Attachment D**. These seeps were identified on the National Wetlands Inventory “Altamont” and “Byron Hot Springs” maps prepared by U. S. Department of Interior in 1987, and in the RUST Environment & Infrastructure, Inc. *Class II Expansion Area Site Characterization Report, Altamont Landfill and Resource Recovery Facility* (RUST report [1994a]). Groundwater seepage is common in the region as evidenced by areas of standing water in the valley bottoms that remains throughout the end of the dry season.
56. Surface water from the east side of the ALRRF and Facility drains eastward to unnamed channels and ditches to Mountain House Creek, which flows to Old River in the Sacramento-San Joaquin Delta. According to the Central Valley Water Board’s *Water Quality Control Plan for the Sacramento and San Joaquin River Basins* (Basin Plan), the beneficial uses of the Sacramento-San Joaquin Delta include: municipal and domestic use (MUN); agricultural supply (AGR); industrial process supply (PRO); water contact recreation (REC-1); non-water contact recreation (REC-2); warm freshwater habitat (WARM); cold freshwater habitat (COLD); wildlife habitat (WILD); migration of aquatic organisms (MIGR); spawning, reproduction and/or early development (SPAWN); and navigation (NAV).
57. In general, groundwater movement in the vicinity of the ALRRF and proposed Solidification Facility is influenced by the local topography along each side of the groundwater divide. Groundwater is recharged mainly by direct infiltration of precipitation into alluvial deposits and weathered bedrock. During the dry months of May through October, discharge likely occurs through evapotranspiration from the shallow soil, with little or no observable storm-water flow. During the wetter months of November through April, groundwater discharge can locally exceed the evapotranspiration potential, resulting in springs and local, intermittent surface flow. Water levels vary seasonally in response to precipitation patterns.
58. According to the Basin Plan, the designated beneficial uses of groundwater at the Facility are municipal and beneficial use (MUN), agricultural supply (AGR), industrial service supply (IND), and industrial process supply (PRO). The Basin Plan also maintains that, for planning and regulatory purposes, the term “groundwater” includes all subsurface waters that occur in fully saturated zones, whether or not they meet the definition of an aquifer.

59. Class III WMUs must be designed and constructed to withstand a maximum probable earthquake without damage to the foundation or to the structures which control leachate, surface drainage, or erosion, or gas, whereas Class II WMUs must withstand a maximum credible earthquake (MCE). (Title 27, § 20370.)
60. According to the ROWD, potentially active faults in the area include the Midway fault (approximately 1.6 miles from the site), the Greenville fault (approximately 3.1 miles from the site), and the Corral Hollow-Carnegie fault (approximately 3.1 miles from the site) No known active faults extend through the proposed Solidification Facility.
61. The West Fault and Huey Faults have been mapped through Fill Area 2 and approximate to the proposed Solidification Basin Facility (**see Attachment E**). The West Fault is mapped through the axis of the main canyon of Fill Area 2 and extends across a small saddle on the southern border of Fill Area 2. The West Fault is steeply dipping, without a large mappable offset across the fault. The Huey Fault daylight northeast of Fill Area 2 and is believed to have similar characteristics to the West Fault.
62. The Discharger's site-specific seismic analysis for the ALRRF indicates the design near-field MCE consists of magnitude 6.7 earthquake resulting in a peak ground acceleration (PGA) of 0.72g and the far-field MCE consists of a magnitude 7.9 earthquake resulting in a PGA of 0.10g, summarized in **Table 2**.

Table 2—Seismic Analysis

Earthquake	Magnitude	Peak Ground Acceleration
Max Credible (MCE)	6.7	0.72 g
Far-Field MCE	7.9	0.10g

See Glossary for definitions of terms and abbreviations in table.

63. Records indicate the West Fault traverses the proposed Facility. William Lettis and Associates performed a fault activity and surface rupture potential investigation at the site and concluded that there are no Holocene active faults present in the expansion area, including the West Fault. As part of the solidification basin design specifications included in the ROWD, the Discharger's structural engineer used seismic design criteria consistent with Table 2.
64. The weather stations nearest to the Facility are Livermore Weather Station, approximately 9 miles away, and Tracy Pumping Weather Station, approximately

4 miles away. Based on data from these weather stations, the Facility has an annual average precipitation of 12.5 to 14.8 inches. These weather stations are reflective of conditions at the Facility.

65. Evaporation data collected for the ALRRF between 1991 and 1997 indicate a mean inferred evaporation of 65.86 inches per year (Simon, 1998). For that period (1991-1997), the highest mean monthly-inferred evaporation was calculated as 10.85 inches for July and the lowest mean monthly-inferred evaporation was calculated as 1.13 inches for December (Simon, 1998).
66. Class II WMUs must be constructed to accommodate stormwater runoff from 24-hour precipitation events with a return period of 1,000 years. (See Title 27, div. 2, subd. 1, ch. 3, subch. 2, art. 4, Table 4.1.) According to National Oceanic and Atmospheric Administration's (NOAA) Precipitation Frequency Atlas 14, Volume 6 (rev. 2014), the Facility's 1,000-year, 24-hour rainfall events are estimated to result in 6.67 inches of precipitation. Source: [NOAA Precipitation Frequency Data Server](https://hdsc.nws.noaa.gov/hdsc/pfds) (<https://hdsc.nws.noaa.gov/hdsc/pfds>).
67. ALRRF stormwater sedimentation basins are located around the ALRRF and subject to WDRs for the ALRRF. The basins detain stormwater for sedimentation control during the rainy season. When stormwater flows are sufficient, stormwater from the sedimentation basins discharges to the San Joaquin River to the east and to the San Francisco Bay toward the west. The ALRRF is covered under the State Water Board's operative General Permit for Storm Water Discharges Associated with Industrial Activities, NPDES Permit No. CAS000001 (Industrial General Permit), WDID 5S01I000600.
68. The Discharger proposes to grade the area around the proposed solidification basins, including the Extender Stockpile Work Area, such that storm water drains to and is contained in the proposed basins.
69. According to the Federal Emergency Management Agency's (FEMA) [Flood Insurance Rate Map](https://msc.fema.gov/portal) (<https://msc.fema.gov/portal>), the Facility is not located within a 100-year floodplain.

Monitoring Networks

70. Title 27 requires the Discharger to conduct a Detection and Monitoring Program for each WMU which satisfies the general water quality monitoring and system requirements of Title 27, sections 20385(a) and 20415. If a facility contains contiguous WMUs, separate groundwater monitoring systems are not required for each such Unit if the Discharger demonstrates to the satisfaction of the Central Valley Water Board that the water quality monitoring program for each Unit will enable the earliest possible detection and measurement of a release from that WMU (Title 27, § 20415(e)(3)).

71. The groundwater monitoring system for the solidification basins shall be designed to distinguish possible releases from the ALRRF from possible releases from the proposed solidification basins. The Discharger's extensive work performed to date for the ALRRF informs and relates to the proposed Solidification Facility but does not yield sufficient information to fully characterize hydrogeographic conditions in the immediate vicinity of the proposed Solidification Facility. These WDRs require the Discharger to develop additional hydrogeological information to fully characterize hydrogeographic conditions specific for the proposed Facility.
72. Title 27 section 21750(g)(7) requires the Discharger to establish background water quality conditions for each WMU based on quarterly sampling data collected from a sufficient number of upgradient background monitoring points for one year (See Title 27, §§ 20415(e)(7)(B), 21750(g)(7)).
73. The groundwater monitoring system for the Facility shall be designed with a sufficient number of background monitoring points (as defined in Title 27, § 20164) installed at appropriate locations and depths to yield groundwater samples from the uppermost aquifer that represent the quality of groundwater that has not been affected by a release from the WMUs and provide the best assurance of the earliest possible detection of a release from the WMUs (Title 27, § 20415).
74. The Discharger's 8 November 2022 proposed Monitoring Plan for the Solidification Basins included a proposal for establishing baseline subsurface conditions and compliance monitoring for the proposed Solidification Facility. The Discharger proposes using ALRRF Monitoring Well 19 (MW-19) and Monitoring Well 52 (MW-52) to evaluate potential changes in groundwater quality associated with solidification basin operations. Upon collection of sufficient background data from ALRRF MW-52, the Discharger intends to propose concentration limits for both wells using intrawell statistical procedures specified in WDRs Order R5-2016-0042-01 and the MRP for the ALRRF. The Discharger further proposed installation of one additional monitoring well (MW-60) north of the proposed solidification basins. On 3 May 2023 the Discharger submitted a responsive workplan for installation of MW-60.
75. ALRRF Monitoring Well 19 (ALRRF MW-19) and Monitoring Well 52 (ALRRF MW-52) are south and southeast of the Facility. ALRRF MW-19 is a detection monitoring well for ALRRF Fill Area 2. ALRRF MW-52 is a Point of Compliance (or final Edge of Waste) groundwater monitoring well for ALRRF Fill Area 2. The Discharger completed installation of ALRRF MW-19 on 30 March 2017. The Discharger completed installation of ALRRF MW-52 on 30 September 2021.

76. Additional groundwater monitoring point(s) between the proposed Solidification Basin Facility and the northern canyon of the ALRRF are appropriate to further distinguish possible releases from the ALRRF from possible releases from the proposed Solidification Facility.
77. Additional hydrogeologic information is necessary to monitor the proposed WMUs and evaluate for potential releases and impacts to water quality.
78. In a 12 May 2023 letter, Central Valley Water Board staff requested the Discharger to complete the following site characterization and groundwater monitoring tasks required prior to authorization of discharge to new WMUs:
 - a. Initiate installation of MW-60 and commence groundwater monitoring as described in the 3 May 2023 workplan (see Finding 74);
 - b. Develop water quality data for use in determination of background concentration value for each indicator parameter or waste constituent by obtaining a minimum of one sample from each monitoring well used to determine background and a minimum of four samples shall be taken from the entire system used to determine background water quality (Title 27, § 21750(g)(7)(D));
 - c. Collect all data necessary for selecting the appropriate data analysis methods establishing the background values. At a minimum, this data shall include analytical data obtained during quarterly sampling of all background monitoring points for a period of one year, including the times of expected highest and lowest annual elevations of the groundwater surface. Title 27 further requires that for a new WMU, this data shall be collected before wastes are discharged at the WMU (Title 27, §§ 20415(e)(6), 20420(c));
 - d. Prepare and submit a report describing and evaluating the hydrogeological conditions in the immediate vicinity of the proposed Solidification Facility. The Hydrogeologic Conditions Report shall consider data obtained from ALRRF MW-19, ALRRF MW-52, MW-60, and any other relevant information relating to the ALRRF or the proposed Solidification Basin Facility; and
 - e. Prepare and submit for Central Valley Water Board review a proposed Detection Monitoring Program for the proposed Solidification Basin Facility, as required by Title 27 sections 20385 and 20425, and, based on the Hydrogeologic Conditions Report:
 - i. Propose additional groundwater monitoring point(s) in location(s) most likely to provide the earliest possible detection of a release

from the ALRRF and which could affect hydrogeologic conditions beneath the proposed Solidification Facility;

- ii. Identify recommended background well(s), within the meaning of Title 27 sections 20415 and 20420; and
- iii. Identify recommended Point of Compliance monitoring well(s) for each proposed WMU, within the meaning of Title 27 sections 20415 and 20420.

79. The Discharger submitted *MW-60 Installation And Hydrogeologic Conditions Report*, dated 31 July 2023. The Report documents the installation of and field activities relating to completion of MW-60. The Report also describes hydrogeologic conditions in the vicinity of the solidification basins with respect to the hydrogeologic conceptual site model for ALRRF previously prepared and presented in the 2001 Hydrogeologic Characterization Report (LFR Levine-Fricke 2001), 2002 Additional Hydrogeology and Geologic Investigations Report (LFR Levine-Fricke 2002), and 2015 Hydrogeologic Evaluation Report (Geosyntec 2015b). The Report includes the following observations:
- a. First groundwater occurs in unweathered bedrock with the depth to groundwater measured on 6 July 2023 ranged from 91.30 feet btoc at ALRRF MW-52 to 26.76 feet btoc at MW-60.
 - b. The groundwater elevations ranged from 744.51 feet above MSL at ALRRF MW-19 to 685.45 feet MSL at MW-60.
 - c. The groundwater flow direction calculated using the groundwater elevations measured at ALRRF MW-19, ALRRF MW-52 and MW-60 on 6 July 2023 was to the northeast with a groundwater gradient of 0.09 feet per foot.
 - d. Based on these results, ALRRF MW-19 is in a recharge area along the groundwater divide and is upgradient of both ALRRF Fill Area 2 located to the south of ALRRF MW-19 and the solidification basins located to the north of ALRRF MW-19.
 - e. The newly installed well MW-60 is downgradient of the proposed solidification basin facility.
 - f. Trace levels of acetone, carbon disulfide, chloroform, naphthalene and styrene have been occasionally reported at ALRRF MW-19 and/or ALRRF MW-52.

80. These WDRs require the Discharger to complete the site characterization and groundwater monitoring tasks which incorporate the elements described in the 12 May 2023 letter (see Finding 78) into Section G. Monitoring Requirements.
81. As of the date of these WDRs, the Proposed Solidification Basin Facility’s **groundwater** monitoring network consists of the monitoring wells summarized in **Table 3**. These WDRs further anticipate inclusion of additional planned monitoring wells described in Finding 78 and required by these WDRs.

Table 3—Groundwater Monitoring Well Network

Well	Program	Monitored Unit	Status
ALRRF MW-19	TBD	Solidification Facility, TBD	Active
ALRRF MW-52	TBD	Solidification Facility, TBD	Active
MW-60	TBD	Solidification Facility, TBD	Active
MW-TBD	TBD	Varies	Planned

See Glossary for definitions of terms and abbreviations in table.

82. As of the date of these WDRs, the Facility’s proposed **unsaturated zone** monitoring network consists of the planned unsaturated zone monitoring points summarized in **Table 4** and depicted in **Attachment H**. These WDRs anticipate inclusion of the planned and potential unsaturated zone monitoring devices described in Finding 83 and required by these WDRs.

Table 4—Unsaturated Zone Monitoring Network

Monitoring Point	Device Type	Program	Monitored Unit	Status
LYS-YFB	Pan Lysimeter	Detection	Yellow Flag Basin	Planned
LYS-BFB	Pan Lysimeter	Detection	Blue Flag Basin	Planned

See Glossary for definitions of terms and abbreviations in table.

83. The Class II surface impoundment containment and detection system proposed in new Class II surface impoundments, depicted in **Attachment F** and **Attachment H**, depict pan lysimeters which are not open to the unsaturated zone (i.e., pan lysimeters welded to the base of the secondary LCRS, hereafter referred to as “welded pan lysimeters” or “WPLs”). The Discharger expressed an intent to modify the pan lysimeter design such that the pan lysimeters are not “welded” to the base of the secondary LCRS but has not provided updated proposed construction details for the modified design. The modified pan lysimeter configuration is expected to serve to provide unsaturated zone monitoring in a manner which satisfies the monitoring requirements of Title 27, pending review of updated proposed construction details.
84. As of the adoption of these WDRs, the above-described networks do not comply with the monitoring requirements of Title 27. (See Title 27, §§ 20415–20435.) These WDRs require the Discharger to evaluate, propose, and implement upgrades and improvements to the monitoring network prior to placing waste in the WMUs identified in **Table 1**. These WDRs provide for a mechanism for incorporation of additional monitoring points required by these WDRs into the Facility MRP (See Monitoring Requirement G.3 and Monitoring Requirement G.4). Changes to these networks may be reflected in a Revised MRP issued by the Executive Officer.

Water Quality Protection Standard

85. A Water Quality Protection Standard (WQPS) is the analytical framework through which WMUs are individually monitored for releases and impacts to water quality. (Title 27, § 20390 (a).) Under Title 27, a WQPS is separately established for each WMU in WDRs. (*Ibid.*)
86. In accordance with Title 27, these WDRs, by virtue of its incorporation of **MRP R5-20XX-XXXX** and subsequent revisions thereto, establish a WQPS for each WMU at the Facility.
87. Concentration Limits developed for the Solidification Facility shall have the primary purpose of supporting the WQPS for the WMUs identified in **Table 1**.
88. The Discharger developed multiple groundwater concentration limits for monitoring parameters for applicable ALRRF Fill Area 1 (FA1) and ALRRF Fill Area 2 (FA2) monitoring wells. The Discharger installed additional monitoring wells at the ALRRF in accordance with provisions contained in Cease and Desist Order R5-2021-0020, adopted on April 22, 2021 (CDO). The CDO provides a separate schedule for collection of background data and development of concentration limits for these wells. Once the final groundwater monitoring well network is in place for the ALRRF, which is anticipated to occur during 2024, the

Discharger intends to synchronize periodic concentration limit to all detection monitoring wells for FA1 and FA2.

89. The Discharger proposes a monitoring and reporting program similar in nature and frequency to the ALRRF monitoring and reporting program. The Discharger further proposes to include Solidification basin operational and monitoring information in routine semiannual monitoring reports for the ALRRF.
90. To minimize the burden, including costs, of preparing concentration limits for the separate, but related ALRRF and Solidification facilities, the Discharger may endeavor to synchronize development of the concentration limits for the Solidification Facility, and revisions made thereto, with the schedule for collection of background data and development of concentration limits periodic concentration limit to all detection monitoring wells for ALRRF FA1 and ALRRF FA2, provided such efforts do not conflict with the requirements of this Order.
91. As of the Date of these WDRs, the Discharger has yet to submit a complete set of Concentration Limits for the Monitoring Parameters identified in MRP R5-20XX-XXXX. These WDRs require the Discharger to provide certain required WQPS elements prior to placement of wastes in the WMUs identified in **Table 1** (See Monitoring Requirement G.3 and Monitoring Requirement G.4).

Unit Construction

92. Liners for **new Class II WMUs** (landfills and surface impoundments) must be designed and constructed to contain fluids (e.g., leachate, waste, and LFG condensate) to prevent the migration of waste to adjacent geologic materials, groundwater, and surface water. (See Title 27, §§ 20310(a), 20330(a).)
93. Liners for **new Class II WMUs** where wastes are discharged and piled for treatment or storage (waste piles) must be designed and constructed to prevent the waste from contacting the underlying land surface, adjacent geologic materials, groundwater, or surface water, during disposal operations, closure, and the post-closure maintenance period and shall be underlain by materials with a hydraulic conductivity of not more than 1×10^{-6} cm/sec (i.e., 1 foot/year). (See Title 27, §§ 20164, 20250(b)(1) and (b)(3), 20310(a), 20330(a).)
94. Class II landfills and waste piles which contain only dry wastes (not including nonhazardous solid waste and decomposable waste) may be allowed to operate without an LCRS if the discharger demonstrates, based on climatic and hydrogeologic conditions, that leachate will not be formed in, or migrate from, the Unit; nevertheless, for a Class II or Class III MSW landfill, after the Federal Deadline for installing liners at that Unit, the LCRS requirements of SWRCB Resolution No. 93-62 apply to all portions outside of the Unit's Existing Footprint. (See Title 27, §§ 20340(a).)

95. The Discharger submitted Construction Plans for the construction of new WMUs at the Facility, specifically the Yellow Flag Basin and Blue Flag Basin, which incorporate an engineered alternative to the Title 27 prescriptive standard for new Class II surface impoundments, depicted in **Attachment F** which are incorporated herein. From top to bottom, the Dischargers propose the following containment and detection system:
- a. Steel trench plate and/or high-strength concrete armor;
 - b. Two feet of reinforced concrete at retaining wall footing; 8-inches for slab floors; (Primary Liner)
 - c. Two feet of engineered fill;
 - d. 16 oz/sy Nonwoven Geotextile;
 - e. 1 foot of LCRS drainage gravel;
 - f. 250-mil Geocomposite (Leak Detection System);
 - g. 60-mil double sided, high density polyethylene geomembrane; (Secondary Liner);
 - h. Geosynthetic Clay Liner (GCL);
 - i. One feet of gravel (Unsaturated Zone Monitoring);
 - j. Pan lysimeter geocomposite;
 - k. 60-mil double sided, high density polyethylene geomembrane; and
 - l. 3 feet minimum foundation layer of engineered fill.
96. From inside to outside, the Dischargers propose the following containment design for the proposed basin access ramp and vertical walls:
- a. Steel trench plate and/or high-strength concrete armor within reach of excavator equipment;
 - b. 1.3 feet thick reinforced concrete at retaining wall footing with a reinforced concrete floor (Primary Liner);
 - c. Geocomposite (Leak Detection System);
 - d. Drainage membrane with stubs facing out (Leak Detection System);

- e. Engineered fill; and
 - f. Gravity flow to the Secondary Liner system described in Finding 95.
97. The proposed designs for access ramps are similar to the basin designs as depicted in **Attachment G**, but do not include unsaturated zone monitoring, as depicted in **Attachment H**. From top to bottom, the Dischargers propose the following containment and detection system for the access ramps which gravity flow at a 10 % slope to the Secondary Liner system described in Finding 95:
- a. Two feet of reinforced concrete at retaining wall footing; 8-inches for slab floors (Primary Liner);
 - b. Two feet of engineered fill;
 - c. 16 oz/sy Nonwoven Geotextile;
 - d. 250-mil Geocomposite (Leak Detection System);
 - e. 60-mil double sided, high density polyethylene geomembrane (Secondary Liner);
 - f. Geosynthetic Clay Liner (GCL) (Secondary Liner); and
 - g. Engineered fill foundation layer.
98. Concrete is a material used in liquid containing structures such as basins, clarifiers, and dams. The measure of the ability of liquids to pass through concrete is referred to as “permeability” and is comparable to “hydraulic conductivity,” both reported in units of distance through time, both related to Darcy’s Law, and both defined Title 27 § 20164. The permeability of concrete is affected by multiple factors including, but not limited to, concrete mix design (water to cement ratios, aggregate characteristics, use of admixtures, etc.), concrete curing time and methods, construction techniques, environmental conditions, and the extent of deterioration of installed concrete. The permeability of mature, good-quality concrete is about 1E-10 cm/sec (*Design and Control of Concrete Mixtures*, 15th Edition, Portland Cement Association). Direct and indirect test methods are available to determine the permeability of concrete.
99. The ROWD describes an intent to seal reinforced concrete construction joints to prevent basin leakage. Concrete expansion joints, seams, changes of plane, cracking, corroded concrete, and corroded reinforcing steel are examples of conditions which may increase the permeability / hydraulic conductivity of an installed reinforced concrete primary liner system. These WDRs require the Discharger to perform regular inspections of installed reinforced concrete liner

systems for evidence of damage including inspection for evidence of cracks, concrete spalling, corrosion of reinforcing steel, or other conditions of deterioration which could reduce the hydraulic conductivity of the installed reinforced concrete primary liner systems.

100. These WDRs require the Discharger to use reasonable methods in accordance with accepted civil engineering practice to demonstrate the hydraulic conductivity of each installed reinforced concrete primary liner system, including at seams, joints, changes of plane, is 1E-06 cm/sec or less throughout the service life of each basin, consistent with the general criteria for containment structures, including construction standards for waste management units (Title 27 § 20320). See Unit Construction Specification D.15.
101. The 1992 EPA guidance document *Action Leakage Rate for Leak Detection Systems* informs theory relating to evaluation and observation of flow rates through surface impoundment containment systems with geomembrane system components. The 1992 EPA guidance, in part, describes that the objective of a containment system is to minimize the head or pressure on the secondary liner and thereby decrease the potential for migration of constituents out of a surface impoundment should a leak occur in both the primary liner and the secondary liner. The 1992 EPA guidance document *Action Leakage Rate for Leak Detection Systems* describes the "action leakage rate" as the maximum design flow rate, with a safety factor, that the leak detection system can remove without the head on the secondary liner exceeding one foot. To protect the secondary liner, action leakage rates must not exceed the maximum leak detection system hydraulic capacity to assure that a response action is triggered for significant leaks.
102. The integrated leak detection system configuration proposed for each basin consists of 1.) the vertical wall leak detection systems (See Finding 96.c); 2) The ramp leak detection systems (See Finding 97.d); and the basin leak detection system (See Finding 95.f), all of which are designed to flow through the basin leak detection system to leachate conveyance pipes described in Finding 105. The integrated leak detection system shall be designed, constructed, operated, and maintained for each basin to account for potential leachate flows contributed by all three leak detection system components combined to ensure leachate removal occurs without the head on the secondary liner exceeding one foot.
103. The 1992 EPA guidance document *Action Leakage Rate for Leak Detection Systems* provides for guidance for geomembrane containment systems where flow rates in excess of the minimum action leakage rates indicate a major localized or general failure of a primary liner; flow rates of 1,000 gallons/acre/day or greater represent "potentially significant hole sizes that may be readily identified and repaired" for geomembrane based containment systems. The

1992 EPA guidance document *Action Leakage Rate for Leak Detection Systems* does not discuss reinforced concrete primary liner systems but notes that appropriate action leakage rates shall be based on site specific circumstances, including, but not limited to, the ease of determining the source of a leak and repairing that leak.

104. The Discharger calculated a maximum leak detection system hydraulic capacity rates of 8,500 gallons/day for the Yellow Flag Basin and 2,500 gallons/day for the Blue Flag Basin based on a leak detection system consisting of a 250-mil thick geocomposite with a 8 oz/sy nonwoven geotextile bonded to each side (See Finding 95.f), and applying flow reduction factors for leachate clogging and chemical clogging pursuant to a standard developed by the Geosynthetic Research Institute (GRI-GC8). The ROWD does not include an evaluation of combined potential leach flows contributed by all three leak detection system components through the basin leak detection system.
105. The Discharger proposes to convey collected leachate from the leak detection systems through dedicated four-inch / eight-inch dual contained HDPE collection pipes for each basin which gravity flow approximately 30 vertical feet to a hydraulic low point on an engineered concrete pad with secondary containment depicted in **Attachment I**. The Discharger proposes to also convey collected secondary leachate from the pan lysimeters through additional dedicated four-inch / eight-inch dual contained HDPE collection pipes for each basin which gravity flow approximately 30 vertical feet to a hydraulic low point on an engineered concrete pad with secondary containment depicted in **Attachment I**. This hydraulic low point, upstream of the air gap between the end of the LCRSs and the storage tanks described in Finding 106, represents the Yellow Flag Basin “sump” and Blue Flag Basin “sump,” as used herein.
106. The Discharger proposes to store leachate collected from the Yellow Flag Basin and Blue Flag Basin leak detection systems in a 15,000-gallon storage tank anchored to an engineered concrete pad with secondary containment. The 15,000-gallon storage tank has capacity to store up to 2,143 gallons per day of combined leachate collected from the Yellow Flag and Blue Flag Basins, for up to seven (7) days. The Discharger also proposes to store secondary liquids collected in the Yellow Flag Basin and Blue Flag Basin pan lysimeters in a 500-gallon storage tank anchored to the same engineered concrete pad with secondary containment, both as depicted in **Attachment I**.
107. For the proposed containment systems, the “site specific circumstances” contemplated by the 1992 EPA guidance document *Action Leakage Rate for Leak Detection Systems*, require consideration of action leakage rate through reinforced concrete primary liner systems which 1.) Ensures leachate removal occurs without the head on the secondary liner exceeding one foot; 2.) Does not

- exceed maximum leak detection system hydraulic capacity rates; and 3.) Allows time to investigate and make repairs to repairs to the reinforced concrete primary liner system without risk of exceeding the capacity of leachate storage system.
108. Title 27 requires the Discharger to notify the Central Valley Water Board within seven (7) days if “progressive increase is detected in the volume of fluid in a leachate collection and removal system” (Title 27, § section 21710(c)(3)). Seven (7) days allows time to investigate and make repairs to repairs to the reinforced concrete primary liner system or take other actions to mitigate potentially significant damage a reinforced concrete primary liner.
 109. Based on the Yellow Flag Basin footprint area described in Table 1, the Yellow Flag Basin area corresponds to 83 percent of the leak detection system catchment area directed to the 15,000-gallon storage tank. Seven (7) days of Yellow Flag Basin leachate storage in the proposed 15,000-gallon dedicated leachate storage tank (Finding 106) for 83 percent of the catchment area corresponds to a maximum leakage rate through the reinforced concrete primary liner system of 1,779 gallons per day and does not exceed the calculated hydraulic capacity rate of 8,500 gallons/day for the Yellow Flag Basin. Removal of fluids in the Yellow Flag Basin leak detection system at 1,779 gallons per day or less is expected to prevent accumulation of liquid head on the secondary liner in excess of one foot and represents a feasible standard of compliance with the “no buildup of hydraulic head” on the secondary liner requirement set forth in Title 27 § 20340(c)).
 110. Based on the Blue Flag Basin footprint area described in Table 1, the Blue Flag Basin area corresponds to 17 percent of the leak detection system catchment area directed to the 15,000-gallon storage tank. Seven (7) days of leachate storage in the proposed 15,000-gallon dedicated leachate storage tank (Finding 106) for 17 percent of the catchment area corresponds to a maximum leakage rate through the reinforced concrete primary liner system of 364 gallons per day and does not exceed the calculated hydraulic capacity rate of 2,500 gallons/day for the Blue Flag Basin. Removal of fluids in the Blue Flag Basin leak detection system at 364 gallons per day or less is expected to prevent accumulation of liquid head on the secondary liner in excess of one foot and represents a feasible standard of compliance with the “no buildup of hydraulic head” on the secondary liner requirement set forth in Title 27 § 20340(c)).
 111. The Discharger submitted Construction Plans for the construction of new waste pile WMU at the Facility, specifically the Extender Stockpile and Work Area, as excerpted in **Attachment C** and **Attachment J**, and as incorporated herein, which incorporate the Title 27 prescriptive standard for new Class II waste piles. The Extender Stockpile and Work Area described in Table 1 includes and is limited to an area less than portions of paved area graded to direct surface flows

to the yellow flag or blue flag basins as depicted in **Attachment C**. The Discharger proposes to use the Extender Stockpile and Work Area for the discharge and temporary storage of noncontainerized, bulk, dry solid waste for use in solidification operations in the Yellow Flag or Blue Flag Basins. From top to bottom, the Discharger proposes an engineered liner system under the Extender Stockpile and Work Area consisting of the following elements:

- a. Asphaltic concrete pavement;
 - b. 12 inches clay with installed hydraulic conductivity of not more than 1E-06 cm/sec; and
 - c. Earthfill / engineered fill subgrade.
112. The Discharger further proposes to contain stormwater runoff by grading to promote surface flows from the Extender Stockpile and Work Area to the Yellow Flag and Blue Flag Basins and installing a 1-foot high curb on the north side and tall curb on the east side (“Extender Concrete Containment Wall”) to prevent unauthorized sloughing of extender materials and stormwater runoff from the Extender Stockpile and Work Area.
113. The gravity drainage design of the Extender Stockpile and Work Area graded to maintain a slope towards the solidification basins and feature an installed containment area with a hydraulic conductivity which does not exceed 1E-06 cm/sec. These design elements combined are expected to prevent the waste from contacting the underlying land surface and prevent vertical fluid movement from the Extender Stockpile and Work Area within the meaning of Title 27 regulations. These WDRs require the Discharger to demonstrate the hydraulic conductivity of the installed Extender Stockpile and Work Area liner system does not exceed 1E-06 cm/sec.
114. Extender materials which accumulate near the top of the Extender Concrete Containment Wall may be vulnerable to unauthorized discharge off the waste pile via sloughing, windblown action, operator error, accident, or other means. An operational margin of safety measured at the face of the Extender Concrete Containment Wall is appropriate to minimize the risk of unauthorized discharge of wastes off the Extender Stockpile and Work Area. These WDRs require the Discharger to operate the Extender Stockpile and Work Area such that extender materials do not accumulate within one foot of the top of the Extender Concrete Containment Wall, as measured at any point in contact with the face of the Extender Concrete Containment Wall.
115. The Discharger demonstrated that the Extender Stockpile and Work Area containment area system installed in compliance with these WDRs, is not expected to result in leachate formation or migration of wastes from the Waste

- Pile Unit other than to either the Yellow Flag or Blue Flag basins. As such, the Extender Stockpile and Work Area containment area system is expected to provide for the storage of noncontainerized, bulk, dry solid waste on an engineered liner system in a manner that prevents the waste from contacting the underlying land surface.
116. The Extender Stockpile and Work Area containment area system installed in compliance with these WDRs, may be allowed to operate without an LCRS pursuant to Title 27 section 20340(a). The conveyance of undiverted precipitation via the surface of the Extender Stockpile and Work Area to the Yellow Flag Basin or the Blue Flag Basin shall be interpreted to satisfy the “leachate collection and removal system” requirements described in Title 27, § 20365(b).
 117. Central Valley Water Board staff are conducting engineering and geologic technical review of the details of the proposed drawings, construction specifications, and Construction Quality Assurance (CQA) Report (collectively “Proposed Construction Details”) documents included in the Discharger’s ROWD. In conducting the technical review, Central Valley Water Board staff are providing feedback to the Discharger regarding the Proposed Construction Details in order for the Discharger to prepare Final Construction Details. Unit Construction Specification D.8 of these WDRs requires written Central Valley Water Board authorization of Final Construction Details prior to the Discharger commencing construction related activities.
 118. The nature of the design review and construction process tends to result in as-built conditions similar to, but different than, conditions described in the available preliminary design documents. As such, these WDRs include representations of preliminary Proposed Construction Details, attached herein as **Attachment C**, **Attachment F**, **Attachment G**, **Attachment H**, **Attachment I**, and **Attachment J** excerpted from the ROWD for informational purposes only.
 119. Unless otherwise specified in Title 27, division 2, subdivision 1, the Central Valley Water Board may approve an engineered alternative to the State Water Board-promulgated construction and prescriptive standards therein (see, e.g., Title 27, § 20330(c)) provided that the Discharger demonstrates that the standard is not feasible and there is a specific engineered alternative that is consistent with the performance goal addressed by the particular standard and affords equivalent protection against water quality. (Title 27, § 20080(b)-(c); State Water Board Resolution 93-62.)
 120. The Discharger has adequately demonstrated that construction of a liner in accordance with the Title 27 prescriptive standard which requires a 2-foot minimum thickness clay liner would be unreasonable and unnecessarily

burdensome for the intended application and use of the Yellow Flag Basin and Blue Flag Basin in comparison to the proposed engineered alternative. The Dischargers have further demonstrated that the proposed engineered alternative(s), as described in **Attachment F** and **Attachment G** are consistent with the performance goals of the prescriptive standard, as described above, and will afford at least equivalent water quality protections.

121. The unsaturated zone monitoring system for future modules shall be implemented in accordance with the operative MRP.
122. According to the submitted seismic analysis, the proposed new WMUs are expected to be able to withstand MCE seismic events described in Finding 62 (Title 27, § 20370.).

Unit Closures

123. Closure of the proposed WMUs identified in **Table 1** is not reasonably anticipated within the effective period of these WDRs. These WDRs require the Discharger to obtain revised WDRs prior to closure of any WMU identified in **Table 1**.

Post-Closure Maintenance & Financial Assurances

124. The Discharger is required to attempt clean closure surface impoundments and waste piles unless the Discharger demonstrates it is infeasible to clean close those WMUs (Title 27, §§ 21400(b)(1), 21410(a)(1)).
125. The Discharger proposes to clean close the Class II surface impoundments and waste pile WMUs identified in **Table 1**, pursuant to Title 27 sections 21400(b)(1) and 20950(a)(2)(A)(1), respectively.
126. For surface impoundments successfully clean-closed, the Central Valley Water Board will declare the surface impoundment no longer subject to the State Water Board-promulgated requirements of Title 27 (Title 27, § 21400(b)(1)).
127. Following successful clean closure of the WMUs identified in **Table 1**, post-closure maintenance is not necessary to prevent adverse impacts on waters of the state.
128. Since the Discharger proposes clean closure of the Solidification Facility, these WDRs do not require the Discharger to develop and maintain a Preliminary Closure and Post-Closure Maintenance Plan pursuant to Title 27 section 21710(a)(3).
129. The ROWD includes a cost estimate of \$426,341 (2023 dollars) for clean closure of the WMUs identified in **Table 1** and other onsite features, systems, and structures described in Finding No. 5 (Title 27, §§ 21820, 22206).

130. Pursuant to Title 27 section 22207(a), these WDRs require the Discharger maintain financial assurances in at least amounts equal to the cost estimates for closure in amounts approved by the Central Valley Water Board, naming the Central Valley Water Board as Beneficiary, and adjusted annually for inflation, to ensure closure in accordance with an approved plan meeting all applicable State Water Board-promulgated requirements of Title 27 division 2, subdivision 1.
131. For closure funding, pursuant to Title 27, § 22207, subdivision (a), the Central Valley Water Board requires operators of Class II surface impoundments to “establish an irrevocable closure fund (or to provide other means) pursuant to [Chapter 6 of Title 27, i.e., §§ 22240-22254] ... to ensure closure ... in accordance with an approved plan meeting all applicable SWRCB-promulgated requirements of [Title 27].” Allowable financial assurance mechanisms are included in §22228. Formulas for calculating minimum fund balances are included in Subchapter 3, Article 1, §22225 and §22226.
132. These WDRs require the Dischargers to establish authorized financial assurance mechanism(s) described in Title 27 § 22228 for closure funding and, which name the Central Valley Water Board as the Beneficiary as specified under Title 27 § 22207, and, if required, Title 27 §§ 22212 and 22222, respectively.

California Environmental Quality Act

133. The Central Valley Water Board has determined that the adoption of these WDRs is exempt from the requirements of the California Environmental Quality Act (CEQA) pursuant to California Code of Regulations, title 14, sections 15301 (Minor Alteration to Existing Facility), 15302 (Replacement or Reconstruction of Existing Facility), and 15061(b)(3) (Common Sense Exemption). As described in the preceding Findings, these WDRs authorize the construction and operation of the proposed 0.8-acre Altamont Solidification Facility within the existing 250-acre footprint of the ALRRF’s Class II Landfill Expansion area (see **Attachment K**). The Solidification Facility is intended to replace and upgrade the ALRRF’s existing solidification facilities to ensure that associated operations are carried out in accordance with applicable law and policy, including but not limited to Title 27 and State Water Board Resolution 93-62. The proposed Solidification Facility will have substantially the same purpose and capacity as the facility being replaced and the associated waste discharges to be authorized by these WDRs are expected to meet water quality parameters that are the same as, or better than, currently applicable parameters. Because the proposed Solidification Facility will replace and upgrade an existing feature of an already existing and operating landfill, it can be seen with certainty that there is no possibility that the activities authorized by these WDRs will have a significant effect on the environment.

Other Regulatory Matters

134. This Order is issued in part pursuant to Water Code section 13263(a), which provides as follows:
- The regional board, after any necessary hearing, shall prescribe requirements as to the nature of any proposed discharge, existing discharge, or material change in an existing discharge ... with relation to the conditions existing in the disposal area ... into which, the discharge is made or proposed. The requirements shall implement any relevant water quality control plans that have been adopted, and shall take into consideration the beneficial uses to be protected, the water quality objectives reasonably required for that purpose, other waste discharges, the need to prevent nuisance, and the provisions of [Water Code] Section 13241.
135. This Order implements the Central Valley Water Board's Basin Plan, which designates beneficial uses for surface waters and groundwaters in the Sacramento River and San Joaquin River Basin and establishes water quality objectives (WQOs) necessary to preserve such beneficial uses.³ (Wat. Code, § 13241 et seq.)
136. The State Water Board's *Statement of Policy with Respect to Maintaining High Quality Waters in California*, Resolution 68-16 (*Antidegradation Policy*) prohibits the Central Valley Water Board from authorizing degradation of "high quality waters" unless it is shown that such degradation: (1) will be consistent with the maximum benefit to the people of California; (2) will not unreasonably affect beneficial uses, or otherwise result in water quality less than as prescribed in applicable policies; and (3) is minimized through the discharger's best practicable treatment or control.
137. Consistent with Title 27, these WDRs require the Dischargers to maintain the Facility to contain waste within WMUs, thereby preventing degradation of water quality. To the extent that there are releases from Facility WMUs, the Discharger will be required to address such releases through a Corrective Action Program. (See Title 27, §§ 20385, 20415, 20430.) Because this Order does not authorize any degradation of high quality waters, it is not subject to the *Antidegradation Policy*.

³ Designated beneficial uses surface water and groundwater are discussed in Finding 56 and Finding 58, respectively.

138. For the purposes of California Code of Regulations, title 23 (Title 23), section 2200, the Facility has a threat-complexity rating of **2-B**, where:
- a. Threat Category “2” reflects waste discharges that can impair receiving water beneficial uses, cause short-term water quality objective violations, cause secondary drinking water standard violations, and cause nuisances; and
 - b. Complexity Category “B” reflects any discharger not included in Category A, with either (1) physical, chemical, or biological treatment systems (except for septic systems with subsurface disposal), or (2) any Class II or Class III WMUs.

Reporting Requirements

139. This Order is also issued in part pursuant to Water Code section 13267(b)(1), which provides that:
- [T]he regional board may require that any person who has discharged, discharges, or is suspected of having discharged or discharging, or who proposes to discharge waste within its region ... shall furnish, under penalty of perjury, technical or monitoring program reports which the regional board requires. The burden, including costs, of these reports shall bear a reasonable relationship to the need for the report and the benefits to be obtained from the reports. In requiring those reports, the regional board shall provide the person with a written explanation with regard to the need for the reports, and shall identify the evidence that supports requiring that person to provide the reports.
140. The technical reports required under this Order, as well as those required under the separately issued MRP, are necessary to ensure compliance with prescribed WDRs and the provisions of Title 27, Subtitle D (40 C.F.R. § 258), and State Water Board Resolution 93-62. Additionally, the burdens associated with such reports are reasonable relative to the need for their submission.
141. Failure to comply with the reporting requirements under this Order and the MRP may result in enforcement action pursuant to Water Code section 13268.

Procedural Matters

142. All local agencies with regulatory jurisdiction over land-use, solid waste disposal, air pollution, and/or public health protection have approved the use of the Facility’s site for the discharge of waste to land as provided for herein.

143. The Discharger, interested agencies, and interested persons were notified of the Central Valley Water Board's intent to prescribe the WDRs in this Order, and provided an opportunity to submit their written views and recommendations at a public hearing. (Wat. Code, §§ 189.7, 13167.5; Title 27, § 21730.)
144. At a public meeting, the Central Valley Water Board heard and considered all comments pertaining to the discharges regulated under this Order.
145. The Central Valley Water Board will review and revise the WDRs in this Order as necessary.

REQUIREMENTS

IT IS HEREBY ORDERED, pursuant to Water Code sections 13263 and 13267, that the Discharger and its agents, employees, successors, and assigns shall comply with the following:

A. Discharge Prohibitions

Except as otherwise expressly directed below, and regardless of the Discharger's operational determination of waste categories, the Discharger shall comply with all Standard Prohibitions (SPRRs, § C), as incorporated herein, as well as the following:

1. **"Hazardous Waste,"** as defined per Title 23 section 2601, shall not be discharged at the Facility. The Central Valley Water Board and DTSC shall be immediately notified of any such discharges in violation of this Order.
2. Except as expressly authorized in **Section B.1 and Table 5**, leachate and LFG condensate shall not be discharged into Facility WMUs.
3. The discharge of asbestos-containing waste (i.e., >1% asbestos) is prohibited.
4. The discharge of treated wood waste, as defined per Title 22 section 67386.4, is prohibited.
5. Wastes containing free liquids shall not be discharged to the Extender Stockpile and Work Area.
6. Except as specifically authorized in **Facility Specification C.10**, storm water runoff from surfaces immediately adjacent to the Yellow Flag Basin and Blue Flag Basin, and from the entirety of the Extender Stockpile and Work Area, shall not be discharged at the Facility.
7. The unauthorized discharge of waste from the Extender Stockpile and Work Area, including overtopping of the Extender Concrete Containment Wall or any other condition resulting in uncontained wastes, is prohibited.

B. Discharge Specifications

Except as otherwise expressly directed below, and regardless of the Discharger's operational determination of waste categories, the Discharger shall comply with all Standard Discharge Specifications (SPRRs, § D), which are incorporated herein, as well as the following.

1. The Discharger shall only discharge waste to Facility WMUs as specified in **Table 5**, subject to the table-specific definitions provided below.

Table 5—Authorized Waste Discharges at Facility

Waste Category	Yellow Flag Basin	Blue Flag Basin	Extender Stockpile And Work Area
<p>Hazardous Waste Wastes which, pursuant to Title 22, § 66261.3 et seq., must be managed in accordance with Division 4.5 of Title 22. (Title 27, § 20164; Title 23, § 2521(a).)</p>	No	No	No
<p>Municipal Solid Waste (MSW) Wastes subject to 40 C.F.R. § 258. (Title 27, § 20164.)</p>	No	No	No
<p>Designated Waste (1) Hazardous Wastes subject to a variance from management requirements per Health and Saf. Code, § 25143; and (2) Nonhazardous Waste containing constituents that, under ambient conditions, could be released in concentrations exceeding WQOs, or could reasonably be expected to affect beneficial uses. (Wat. Code, § 13173.)</p>	Yes	Yes	Yes
<p>Inert Wastes Wastes that contain neither (i) hazardous wastes or soluble pollutants at concentrations in excess of WQOs, nor (ii) significant quantities of decomposable material. (Title 27, §§ 20164, 20230(a).)</p>	Yes	Yes	Yes

Waste Category	Yellow Flag Basin	Blue Flag Basin	Extender Stockpile And Work Area
<p>Leachate Liquid formed by the drainage of liquids from waste or by the percolation or flow of liquid through waste. Includes any constituents extracted from the waste and dissolved or suspended in the fluid. (Title 27, § 20164.)</p>	<p>Return From Yellow Flag or Blue Flag Basins Only</p>	<p>Return From Yellow Flag or Blue Flag Basins Only</p>	<p>No</p>
<p>Undiverted Precipitation Precipitation on waste piles which is not diverted by covers or drainage control systems shall be collected and managed through the leachate collection and removal system. (Title 27, § 20365.)</p>	<p>Yes</p>	<p>Yes</p>	<p>Not Applicable (See Finding 116)</p>

2. The Discharger shall promptly remove all wastes discharged at the Facility in violation of this Order. If unable to do so, they shall submit a report to the Central Valley Water Board explaining how the violative discharge(s) occurred and why the waste(s) cannot be feasibly removed and proposing waste acceptance program updates to prevent reoccurrences. If the infeasibility is economic, cost estimates shall be provided as part of the report.⁴ All removed wastes shall be disposed of in accordance with State and Federal Regulations.
3. The Discharger shall not apply solidified wastes to areas other than as authorized for the ALRRF unless:

⁴ Submission of this letter does not constitute approval for discharge. The Central Valley Water Board may direct the removal of waste not authorized under this Order.

- a. The Discharger demonstrates that resulting runoff will not pose a threat to surface water quality (accounting for sediment and suspended solids removal in a sedimentation basin); and
 - b. The Central Valley Water Board approves the demonstration in writing.
4. The Discharger shall not discharge any waste to, or operate, the waste pile in a manner which results in a condition where the waste pile contains liquid in excess of the moisture-holding capacity of the waste pile. Such wastes shall only be discharged to a surface impoundment or to another Unit with containment features equivalent to a surface impoundment. (See Title 27, § 20200(d))
 5. Notwithstanding **Section B.1** and **Table 5**, leachate from the WMUs shall not be discharged to other WMUs unless approved in writing by the Central Valley Water Board. (See Title 27, § 20340.)
 6. The Discharger shall remedy any evidence of damage including cracks, concrete spalling, corrosion of reinforcing steel, or other conditions of deterioration observed in an installed reinforced concrete primary liner system and which may result in degradation reasonably believed to reduce containment system integrity.
 7. The Discharger shall remedy any settlement, ponding, and/or cracking observed in the Extender Stockpile and Work Area and which may result in degradation reasonably believed to reduce containment system integrity.

C. Facility Specifications

The Discharger shall comply with all Standard Facility Specifications (SPRRs, § E), as incorporated herein, as well as the following:

1. The Discharger shall use, store, and accumulate TASW at the Solidification Basin Facility in manner consistent with applicable statutes, regulations, and policies administered by the DTSC and CalRecycle.
2. Prior to accepting wastes for discharge to authorized WMUs, the Discharger shall take measures to ensure that the waste in each load meets criteria set forth herein, including but not limited to the **Discharge Prohibitions** and **Discharge Specifications** of these WDRs, and in accordance with waste acceptance monitoring requirements specified in MRP R5-20XX-XXXX and any subsequent revisions thereto.

3. Discharger shall perform and report waste characterization of liquids stored in in each basin, as required by MRP R5-20XX-XXXX.
4. The Discharger shall record onsite rainfall to track the magnitude of storm events and shall record surface impoundment freeboard levels in each basin as required by MRP R5-20XX-XXXX.
5. The Discharger shall maintain at least minimum required freeboard for Class II surface impoundments, as described in in Finding 32. (See Title 27, § 20375(a)).
6. In the event that freeboard levels are not in compliance with freeboard requirements of these WDRs, the Discharger shall **immediately** notify Central Valley Water Board staff by telephone and electronic mail and **immediately** take measures to regain surface impoundment capacity.
7. Leachate volumes pumped from the LCRS sumps of all surface impoundments shall be measured, recorded, and reported.
8. The depth of the fluid in any LCRS sump shall be kept at the minimum needed for safe pump operation without excessive pump cycling that could damage the pump.
9. Leachate removed from a surface impoundment's primary LCRS shall be discharged to either authorized Storage Tanks (See Finding 106) or the surface impoundment from which it originated or to a different surface impoundment authorized to receive leachate wastes and with available freeboard.
10. Storm water runoff from surfaces immediately adjacent to the Yellow Flag Basin, Blue Flag Basin, and from the entirety of the Extender Stockpile and Work Area shall be discharged to a surface impoundment authorized to receive leachate wastes, as authorized in **Section B.1** and **Table 5, Leachate**.
11. The **Action Leakage Rate** (ALR) shall provide for a minimum of seven (7) days of dedicated leachate storage and be less than the maximum calculated leak detection system hydraulic capacity rate.

For the Yellow Flag Basin with the proposed 15,000-gallon dedicated leachate storage, the corresponding ALR is 1,779 gallons per day or 53,370 gallons over a 30-day period. Changes in dedicated leachate storage capacity for the Yellow Flag Basin may result in modifications to the ALR.

For the Blue Flag Basin with the proposed 15,000-gallon dedicated leachate storage, the corresponding ALR is 364 gallons per day or 10,920 gallons over a 30-day period. Changes in dedicated leachate storage capacity for the Blue Flag Basin may result in modifications to the ALR.

If leachate generation in the LCRS of a Class II surface impoundment exceeds its ALR, the Discharger shall:

- a. Immediately notify Central Valley Water Board staff by telephone and email.
 - b. Submit written notification within seven days that includes a time schedule to locate and repair the leak(s) in the reinforced concrete primary liner system or take other actions to mitigate the exceedance.
 - c. If initial repair attempts or other actions do not result in a leakage rate less than the required ALR, the Discharger shall submit written notification within seven days that includes a time schedule for a leak location test, identification of damaged or non-performing areas of the reinforced concrete primary liner, and replacement or repair of the identified damaged or non-performing areas reinforced concrete primary liner of the surface impoundment or other action necessary to reduce leachate production below the ALR.
 - d. Complete repairs, other actions, or liner replacement in accordance with the approved time schedule(s) required under Facility Specifications C.11.b and/or C.11.c, above.
12. If a monitoring device for the unsaturated zone monitoring system for a Class II surface impoundment indicates a leak in the containment structures, the Discharger shall:
- a. Immediately notify Central Valley Water Board staff by telephone and email that the containment structures may have failed.
 - b. Immediately conduct resampling of the lysimeter and test the liquid in accordance with the unsaturated zone monitoring requirements in MRP R5-~~20XX-XXXX~~.
 - c. As soon as the retest data are available, submit the resampling results and if re-sampling confirms the release, submit written notification of the release to Central Valley Water Board staff within

seven days including a time schedule to repair the containment structures or take other actions to mitigate the leak.

- d. Complete repairs of the containment structures or other actions in accordance with the approved time schedule.
13. To prevent overtopping, sloughing, instability, or condition which may result in discharge of uncontained wastes, the Discharger shall operate the Extender Stockpile and Work Area such that extender materials do not accumulate to a height within one foot of the top of the Extender Concrete Containment Wall, as measured at any point in contact with the face of the Extender Concrete Containment Wall.
14. The Central Valley Water Board may require the Discharger to utilize an interim cover on waste piles which meets the standards set forth in Title 27 section 20705. (Title 27, §§ 20310, 20705)
15. All visible portions of synthetic liners shall be inspected weekly until all free liquid is removed from the surface impoundment as part of closure pursuant to Title 27 section 21400(a). If, during the active life of the impoundment, the wastes are removed and the bottom of the impoundment is cleaned down to the liner, an inspection shall be made of the bottom of the liner prior to refilling of the impoundment (Title 27, § 20375(f)).
16. The Discharger shall perform regular inspection of the installed reinforced concrete liner systems for evidence damage including inspection for evidence of cracks, concrete spalling, corrosion of reinforcing steel, or other conditions of deterioration which could reduce the hydraulic conductivity of the liner system.
17. By **15 November** of each year, the Discharger shall submit an Annual Operations Plan for operating the surface impoundments and waste pile over the period from 1 October through the following 30 September, inclusive. The Annual Operations Plan shall describe the liquid waste acceptance protocols, solidification agents and mixing procedures, basin integrity monitoring, waste pile surface and containment integrity monitoring, inspection protocol, record keeping and reporting, and training protocol that will be implemented as part of solidification operations.

D. Unit Construction Specifications

Except as otherwise expressly directed below, the Discharger shall comply with all Standard Construction Specifications and Standard Storm Water Provisions (SPRRs, §§ D, L), which are incorporated herein, as well as the following:

1. Containment structures and precipitation and drainage control systems shall be constructed and maintained to prevent, to the greatest extent possible, inundation, erosion, slope failure, and washout under 1,000-year, 24-hour precipitation conditions.
2. WMUs shall be designed, constructed, and operated to prevent inundation or washout due to flooding events with a 100-year return period.
3. All LCRS pumps shall be capable of removing design volumes of leachate and/or 150 percent of the ALR flow, whichever is greater.
4. The Discharger shall demonstrate that the installed containment system for the Extender Stockpile and Work Area has a hydraulic conductivity of not more than 1E-06 cm/sec. The Discharger shall perform all maintenance and repair activities necessary to maintain a hydraulic conductivity of not more than 1E-06 cm/sec for the containment system for the Extender Stockpile and Work Area throughout the duration of authorized use.
5. New Class II surface impoundment liner systems shall consist of the minimum containment and detection components as described in **Finding 95, Finding 96, and Finding 97**.
6. The Discharger shall use reasonable methods in accordance with accepted civil engineering practice to demonstrate the installed hydraulic conductivity of all concrete liner systems, inclusive of all seams, joints, change of plane, are 1E-06 cm/sec or less throughout the service life of each basin.
7. New Waste piles shall consist of the minimum containment components as described in **Finding 111 and Finding 112**.
8. The Discharger shall not commence construction of the WMUs listed in **Table 1** (other than preparatory earthmoving and grading) until the Central Valley Water Board has approved in writing all necessary final construction plans, specifications, and CQA plans related to construction of the WMUs listed in **Table 1** (Final Construction Details).
9. The Discharger shall not implement material changes to approved liner designs in **Attachment F** or **Attachment G** until the Central Valley Water Board approves of the proposed changes in writing, provided that the proposed changes meet the following specifications:
 - a. Previously approved containment and detection components are not eliminated;

- b. The engineering properties of previously approved containment and detection components are not substantially reduced; and
 - c. The proposed liner system will result in water quality equal to or greater than the design(s) prescribed per Title 27, division 2, subdivision 1, chapter 3, subchapter 2 (§ 20310 et seq.), and this Order.⁵
10. New or retrofitted Class II surface impoundments shall have at least one downgradient groundwater monitoring well as part of their design. The well shall be installed and sampled prior to acceptance of waste in the impoundment and shall be monitored in accordance with groundwater detection monitoring requirements in MRP R5-2023-XXXX and any subsequent revisions thereto.
11. The Discharger shall include as part of any proposed design demonstration of satisfaction of financial assurance requirements for new or retrofitted Class II surface impoundments, as described in Financial Assurance Specification F, below.
12. The Discharger shall apply and maintain physical markings and signage delineating the extent of the key Facility features. Physical markings and signage shall be visible and discernable to employees, contractors, customers, and visitors to the Facility. Subject key Facility features include the following:

⁵ Proposed changes that do not meet these criteria are considered “material,” and will require the revision of this Order.

- a. The highest elevation of the leak detection system behind the vertical walls of the Yellow Flag Basin (including the ramp) to support evaluation of available freeboard (see Finding 32);
 - b. The highest elevation of the leak detection system behind the vertical walls of the Blue Flag Basin (including the ramp) to support evaluation of available freeboard (see Finding 32);
 - c. The perimeter of the Extender Stockpile and Work Area; and
 - d. A horizontal line one foot below the top of the extender concrete containment wall.
13. The Discharger shall maintain the operational surface of the Extender Stockpile and Work Area in a condition which does not threaten the integrity of the underlying low permeability clay layer.
 14. The Discharger shall not commence placement of wastes into any WMU identified in **Table 1** without the written authorization of the Central Valley Water Board.
 15. Prior to authorization of use, the Discharger shall demonstrate that the installed reinforced concrete primary liner system can achieve the Action Leakage Rates prescribed by these WDRs by performing and passing a flood test of each installed reinforced concrete primary liner system. Each flood test shall occur by flooding a basin with water to the minimum freeboard elevation prescribed by these WDRs (i.e., two feet measured vertically from the water surface the top of the signage/demarcation point required by Unit Construction Specification D.12) for a period of 7 days. For the duration of the flood test, the Discharger shall monitor the leak detection conveyance pipelines and sumps for leaks, monitor the total flow and flow rate through the sump, and report the observed results, including the average and maximum observed leakage rates at the sump.

If an observed leakage rate during a seven-day flood test exceeds an Action Leakage Rate at any time **or** leakage in the conveyance pipelines is detected, the installed reinforced concrete primary liner system is deemed to have failed the flood test; the use of the basin may not be authorized; and the Discharger shall immediately notify the Central Valley Water Board staff by telephone and follow up in writing within seven days describing the observed failure(s) and known circumstances related to the failure(s). The Discharger shall investigate and evaluate the potential source(s) of failure and make appropriate repairs and modifications. The Discharger shall repeat the flood test until all observed leakage rates

during a seven-day flood test are less than the Action Leakage Rate for the basin and no leakage in the conveyance pipelines is detected.

When all observed leakage rates during the flood test are less than the Action Leakage Rate for each respective basin **and** no leakage in the conveyance pipelines is detected, the installed reinforced concrete primary liner system passes the flood test and the Central Valley Water Board may consider authorization of use of the basin (subject to completion of all relevant tasks required by these WDRs).

The Discharger shall incorporate the results of all flood tests into a Surface Impoundment Liner Performance Evaluation Report which may be included in the CQA report. At a minimum, the results of installed reinforced concrete primary liner system flood test results shall include a tabulation of pumping activity at the sump, evaluation of results against the respective ALR, measures employed to detect leakage in the conveyance pipelines, and a description of all repairs and modifications made in order to pass the flood test.

16. The Discharger shall perform a leak location test on each installed geomembrane in a Class II surface impoundment containment system to find any defects in the geomembrane due to ultraviolet degradation, normal wear and tear, construction and installation damage, or other activities. The Discharger shall repair all defects and employ measures necessary to ensure geosynthetic materials meet and continue to meet all manufacturer's specifications, including during periods where a geosynthetic material may be exposed to environmental conditions, including ultraviolet light, varying temperatures, and climatic conditions is. The Discharger shall include the results of leak location tests in a Surface Impoundment Secondary Liner Performance Evaluation Report to be included in the CQA report. The Surface Impoundment Secondary Liner Performance Evaluation Report shall include the following elements:
 - a. Results from the liner leak location test;
 - b. A description of geosynthetic material repairs made, if required; and
 - c. Corrective action recommendations, if required.
17. **Within 90 days of completion of approved construction**, the Discharger shall submit As-Built Drawings for the Yellow Flag Basin, Blue Flag Basin, and Extender Stockpile and Work Area, in accordance with Title 27 section 21760(a)(1). The As-Built Drawings shall include details, specifications, and descriptions for all liners (Title 27, § 20330) and other containment structures (e.g., final cover) (see *id.*, § 21090), LCRS

components (*id.*, § 20340), leak detection system components [*id.*, § 20415(b)-(d)], precipitation and drainage control facilities (*id.*, § 20365), and interim covers installed or to be installed or used (*id.*, § 20705). In addition, the As-Built Drawings shall contain a description of, and location data for, ancillary facilities including roads, waste handling areas, buildings, and equipment cleaning facilities, insofar as the location and operation of these ancillary facilities could affect water quality.

E. Closure Specifications

Except as otherwise directed below, the Discharger shall comply with all Standard Closure and Post-Closure Specifications (SPRRs, § G) and closure-related Standard Construction Specifications (SPRRs, § F), as well as the following with respect to closure of waste management units at the Facility:

1. The Discharger shall attempt clean close Class II surface impoundments pursuant to Title 27 section 21400(b)(1). Partial or final closure of a Facility Class II surface impoundment shall not occur without Central Valley Water Board authorization. Closure shall be conducted as required by this Order.
2. Clean closure of Class II surface impoundments shall consist of removing all water, solids, liner materials, and adjacent natural geologic materials contaminated by wastes. Liquids may be discharged to Class II surface impoundment authorized to receive the wastes. Solids, liner materials, and contaminated natural geologic materials shall be discharged to a permitted landfill facility. Geotextiles, concrete, and steel shall either be recycled or discharged to a permitted landfill facility. The area shall be backfilled to approximate surrounding natural grade and graded to drain.
3. The Discharger shall attempt to clean close waste piles pursuant to Title 27 § 21410(a)(1). Solids, liner materials, and contaminated natural geologic materials shall be discharged to a permitted landfill facility. Geotextiles, concrete, and steel shall either be recycled or discharged to a permitted landfill facility. The area shall be backfilled to approximate surrounding natural grade and graded to drain. Partial or final closure of a Facility waste pile shall not occur without Central Valley Water Board authorization. Closure shall be conducted as required by this Order.
4. Partial or final closure of a Facility Class II surface impoundment or waste pile closed as a landfill pursuant to Title 27 § 20950(a)(2)(A) shall not occur without a Final or Partial Final Closure and Post Closure Maintenance Plan, prepared in accordance with section G of the SPRRs,

and approved by the Central Valley Water Board at least two years prior to the proposed closure of any portion of any WMU.

5. Partial or final closure of a Facility Class II surface impoundment shall not occur without Central Valley Water Board authorization.

F. Financial Assurances

Except as otherwise directed below, the Discharger shall comply with the following.

1. The Discharger shall use one or more acceptable financial mechanisms (see Title 27, § 22228), naming the Central Valley Water Board as Beneficiary, to maintain assurances of financial responsibility in at least the estimated Clean Closure cost amount specified in Finding 129, adjusted annually for inflation (see *id.*, § 22236).
2. Acceptable financial mechanisms shall be fully funded at the time the Discharger receives and discharges the final shipment of waste into a WMU (Title 27, § 22225(a)(3)).
3. Groundwater corrective action fund balance calculations shall be made in accordance with the formulas in Title 27 § 22226. The Dischargers shall make payment to the corrective action fund in at least the amount that the fund would contain if the fund were established initially, and annual payments made in accordance with the formulas in Title 27 § 22226(a)(4).
4. **By 1 October 2024**, the Discharger shall demonstrate the acceptable financial mechanism(s) established pursuant to Financial Assurances F.1 is a valid executed agreement that identifies the parties responsible for all aspects of the administration of the financial mechanism(s) and names the Central Valley Water Board as Beneficiary, as described in Title 27 section 22228 and required under sections 22207, 22212, and 22222, by completing the following tasks:
 - a. Submit true, correct, complete, and fully executed copy of the financial mechanism(s) established for Closure, certified under penalty of perjury; and
 - b. Demonstrate with financial records, certified under penalty of perjury, that available funds are deposited into or held by the respective irrevocable trusts.
5. Any attestations, certifications, or statements of authenticity made by a financial institution, or its agents, employees, or representatives, regarding financial assurances documents or reports required by this Order shall be

made on financial institution letterhead by a representative, employee, or agent duly authorized to make attestations, certifications, or statements of authenticity on behalf of the financial institution. The Central Valley Water Board reserves the right to issue orders, requests, and/or administrative subpoenas to financial institutions to verify the authenticity and adequacy of financial mechanisms and/or obtain additional information relating to financial assurance mechanisms maintained on behalf of the Discharger related to this Order.

6. By **1 June of each year**, the Discharger shall submit an Annual Financial Assurances Report to the Central Valley Water Board, including:
 - a. The balance of the closure fund(s) and the adjustments to funds for inflation in accordance with Title 27 section 22236; and
 - b. Description of the methodology used for calculating the required minimum deposits and documentation of the information required used in the calculations.
7. If the Executive Officer determines that demonstrated financial assurances for the Facility are inadequate, the Discharger shall, within 90 days of such determination:
 - a. Obtain a new financial assurance mechanism for the amount specified by Executive Officer; and
 - b. Submit a report documenting such financial assurances to CalRecycle and the Central Valley Water Board.
8. Whenever changed conditions increase the estimated costs of clean closure, the Discharger shall promptly submit an updated cost estimate to the Central Valley Water Board.

G. Monitoring Requirements

Except as otherwise directed below, the Discharger shall comply with all applicable Standard Monitoring Specifications (SPRRs, § I) and Standard Response to Release Specifications (SPRRs, § J), as well as the following:

1. The Discharger shall comply with all provisions of the separately issued MRP R5-20XX-XXXX and any subsequent revisions thereto (operative MRP).
2. The Discharger shall implement the Water Quality Protection Standard (WQPS) set forth in the operative MRP (see also Title 27, § 20390); and

shall verify the compliance of each WMU with each subsequent monitoring event.

3. **By 3 June 2024**, the Discharger shall submit a proposed Detection Monitoring Program (Title 27, § 20385) including, at a minimum, the following elements:
 - a. Proposes additional groundwater monitoring point(s) in location(s) most likely to provide the earliest possible detection of a release from the ALRRF and which could affect hydrogeologic conditions beneath the proposed Solidification Facility;
 - b. Recommend background wells, within the meaning of Title 27 sections 20415 and 20420; and
 - c. Recommend Point of Compliance monitoring wells within the meaning of Title 27 sections 20415 and 20420.
4. In preparing the Detection Monitoring Program required by Monitoring Requirements G.3, the Discharger may use ALRRF MW-19, ALRRF MW-52, and MW-60 to develop interim background water quality data for the purposes of satisfaction Title 27 section 20415(e)(6) and 21750(g)(7). The Executive Officer, upon reviewing the Detection Monitoring Program required by Monitoring Requirements G.3, may determine whether ALRRF MW-19, ALRRF MW-52, and MW-60 are “background” or “detection” monitoring wells for the Solidification Facility, within the meaning of Title 27 sections 20415 and 20420.
5. For all WMUs, the Discharger shall implement a groundwater and unsaturated zone detection monitoring program in accordance with Title 27, sections 20385, 20415, and 20420.
6. **By 1 August 2024**, the Discharger shall provide the required WQPS elements set forth in Monitoring Requirements G.4 prior to placement of wastes in the WMUs identified in **Table 1** for Central Valley Water Board review and approval. The WQPS shall consist of the list of constituents of concern (under Title 27, § 20395), the concentration limits (*id.*, § 20400), and the Point of Compliance and all Monitoring Points (*id.*, § 20405). This WQPS shall apply during the active life of the Unit, the closure period, the post-closure maintenance period, and during any compliance period (*id.*, § 20410).
7. **By 3 June 2024**, the Discharger shall submit for Central Valley Water Board review and approval proposed specifications, drawings, and data for location and installation of unsaturated zone monitoring devices at the

WMUs identified in **Table 1** for incorporation into the Detection Monitoring Program (Title 27, § 20415(d)). The Discharger shall either modify the pan lysimeter design described in **Attachment F** and **Attachment H** and/or provide unsaturated zone monitoring to satisfy the monitoring requirements of Title 27.

8. For each WMU subject to corrective action, the Discharger shall implement a Corrective Action Monitoring Program (CAMP) in accordance with Title 27 sections 20385, 20415 and 20430, and Section I of the SPRRs.
9. The Discharger shall prepare and submit a Sample Collection and Analysis Plan (SCAP) for detection monitoring and a SCAP for liquid waste monitoring, both for Central Valley Water Board approval. The Discharger may maintain separate SCAPs for detection monitoring and for liquid waste monitoring. **By 1 July 2024**, at a minimum, the SCAPs shall include the following elements: a. Sample collection procedures describing purging techniques, sampling equipment, and decontamination of sampling equipment; b. Sample preservation information and shipment procedures; c. Sample analytical methods and procedures; Sample quality assurance/quality control (QA/QC) procedures; and d. Chain of Custody control. The Discharger submitted a Liquid Waste Sample Collection and Analysis Plan for solidification Operations, dated 12 March 2024, which satisfies these minimum requirements and is incorporated into MRP R5-20XX-XXXX.
10. All samples shall be collected, preserved and transported in accordance with the approved SCAP and the Quality Assurance/Quality Control (QA/QC) standards specified therein. The Discharger may use alternative analytical test methods (including new USEPA-approved methods) provided that the alternative methods have method detection limits (MDLs) equal to or lower than the analytical methods specified in this MRP and are identified in the approved SCAP.

H. Reporting Requirements

In addition to those Standard Provisions pertaining to notification and reporting obligations (see, e.g., §§ K.1-2, K.6, K.8-10), the Discharger shall comply with the following provisions.

1. The Discharger shall comply with all MRP provisions pertaining to the submittal and formatting of reports and data.
2. Reports shall be submitted electronically via the State Water Board's [GeoTracker Database](https://geotracker.waterboards.ca.gov) (<https://geotracker.waterboards.ca.gov>). After

uploading, the Discharger shall notify Central Valley Water Board staff via email at CentralVallySacramento@WaterBoards.ca.gov. The following information shall be included in the body of the email:

Attention: Title 27 Compliance & Enforcement Unit
Report Title: [Report Title]
GeoTracker Upload ID: L10005834311
Facility: Altamont Solidification Facility
County: Alameda County
CIWQS Place ID: 888337

3. All technical reports submitted under this Order shall be prepared by, or under the direct supervision of, a California-licensed civil engineer or engineering geologist or a Registered Geologist where allowed by law (See Business and Professions Code §§ 7800 – 7887). For the purposes of this section, a “technical report” is a report incorporating the application of scientific or engineering principles.

I. Time Schedule

The Discharger shall complete the following tasks in accordance with the specified deadlines:

Table 6—Time Schedule

Item No.	Category	Task	Deadline
1.	Construction	Submit construction and design plan(s) for review and approval in accordance with Section D of this Order, and Section F of the SPRRs.	90 Days Prior to Proposed Construction
2.	Construction	Submit construction report(s) for review and approval upon completion demonstrating construction was in accordance with approved construction plans and Section F.27 of the SPRRs.	60 Days Prior to Proposed Discharge to Unit(s)
3.	Financial Assurances	Demonstrate the acceptable financial mechanism(s) established pursuant to Financial Assurances F.1 are valid executed agreements.	1 October 2024

Item No.	Category	Task	Deadline
4.	Financial Assurances	Annual Financial Assurances Report	1 June Annually
5.	Detection Monitoring Program	Discharger shall submit a proposed Detection Monitoring Program, as required by Title 27 § 20385	3 June 2024
6.	WQPS	Provide required WQPS elements set forth in Monitoring Requirements G.4 prior to placement of wastes in the WMUs.	1 August 2024
7.	Unsaturated Zone Devices	Submit proposed specifications, drawings, and data for location and installation of unsaturated zone monitoring devices for incorporation into the Detection Monitoring Program	3 June 2024
8.	SCAP	Prepare and submit a complete Sample Collection and Analysis Plan (SCAP) for Central Valley Water Board approval.	1 July 2024
9.	Operations Plan	Annual Operations Plan	15 November Annually
10.	Final Construction Details	Final Construction Details for Central Valley Water Board review and consideration of approval	3 June 2024
11.	Construction	As-Built Drawings	Within 90 Days of completion of construction
12.	Final Closure	Submit final or partial final closure and post-closure maintenance plan (PCMP), design plans, and CQA plan for review and approval, in accordance with Section E of this Order and Section G of the SPRRs.	2 Years Prior to Closure

J. Other Provisions

1. The Discharger shall maintain at the Facility copies of this Order (including all attachments), the operative Monitoring & Reporting Program (i.e., MRP R5-20XX-XXXX and any revisions thereto), and the SPRRs. These materials shall be made available to all operating personnel, who shall be familiar with the contents of such materials.
2. The Discharger shall comply with all applicable provisions of Title 27 and the SPRRs, including those provisions not specifically referenced herein.
3. By **3 June 2024**, the Discharger shall submit Final Construction Details for Central Valley Water Board review and consideration of approval pursuant to Construction Specification D. 8.

ENFORCEMENT

If, in the opinion of the Executive Officer, the Dischargers fail to comply with the provisions of this Order, the Executive Officer may refer this matter to the Attorney General for judicial enforcement, may issue a complaint for administrative civil liability, or may take other enforcement actions. Failure to comply with this Order may result in the assessment of Administrative Civil Liability of up to \$10,000 per violation, per day, depending on the violation, pursuant to the Water Code, including §§ 13268, 13350, and 13385. The Central Valley Water Board reserves its right to take any enforcement actions authorized by law.

ADMINISTRATIVE REVIEW

Any person aggrieved by this Central Valley Water Board action may petition the State Water Board for review in accordance with Water Code § 13320 and California Code of Regulations, title 23, § 2050 et seq. To be timely, the petition must be received by the State Water Board by 5:00 pm on the 30th day after the date of this Order; if the 30th day falls on a Saturday, Sunday or state holiday, the petition must be received by the State Water Board by 5:00 pm on the next business day. The law and regulations applicable to filing petitions are available on the [State Water Board website](http://www.waterboards.ca.gov/public_notices/petitions/water_quality) (http://www.waterboards.ca.gov/public_notices/petitions/water_quality). Copies will also be provided upon request.

ATTACHMENT A—SITE LOCATION MAP

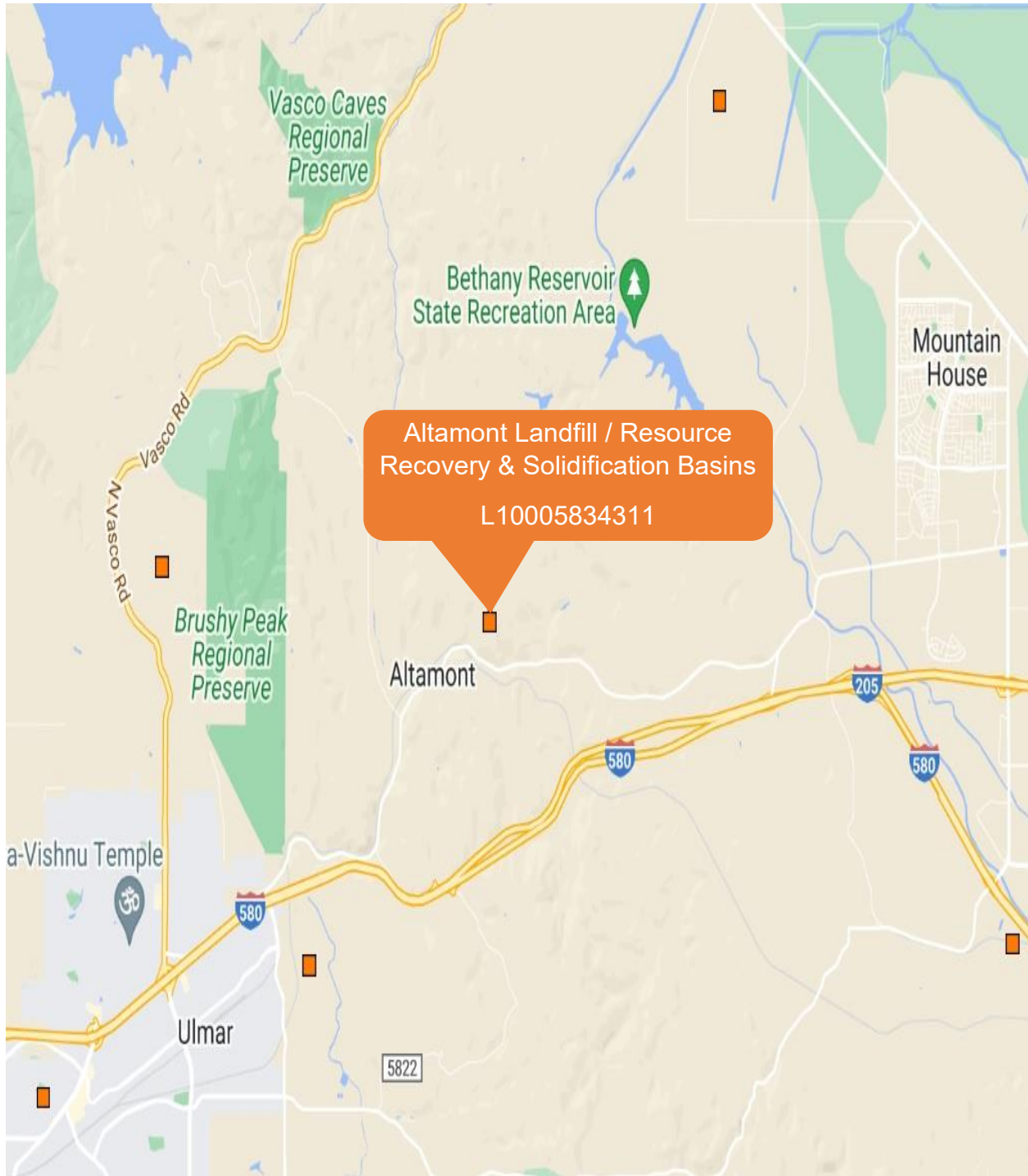

Site Location Map, GeoTracker®

ATTACHMENT B—SOLIDIFICATION BASIN AREA

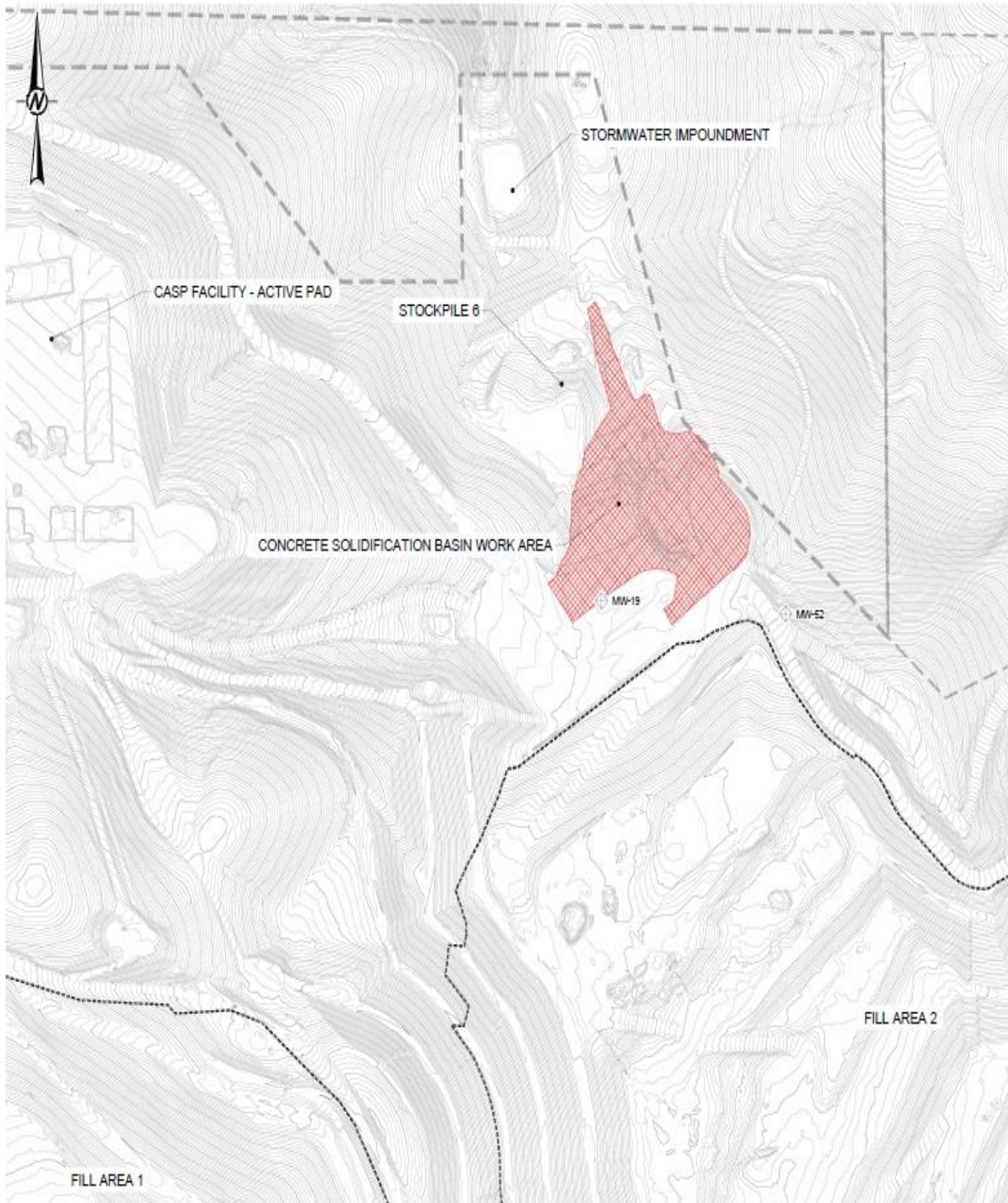

Excerpt of Solidification Basin Area, ROWD Revision 1, 30 June 2022, NTS

ATTACHMENT C—SOLIDIFICATION FACILITY PROPOSED FINAL GRADE

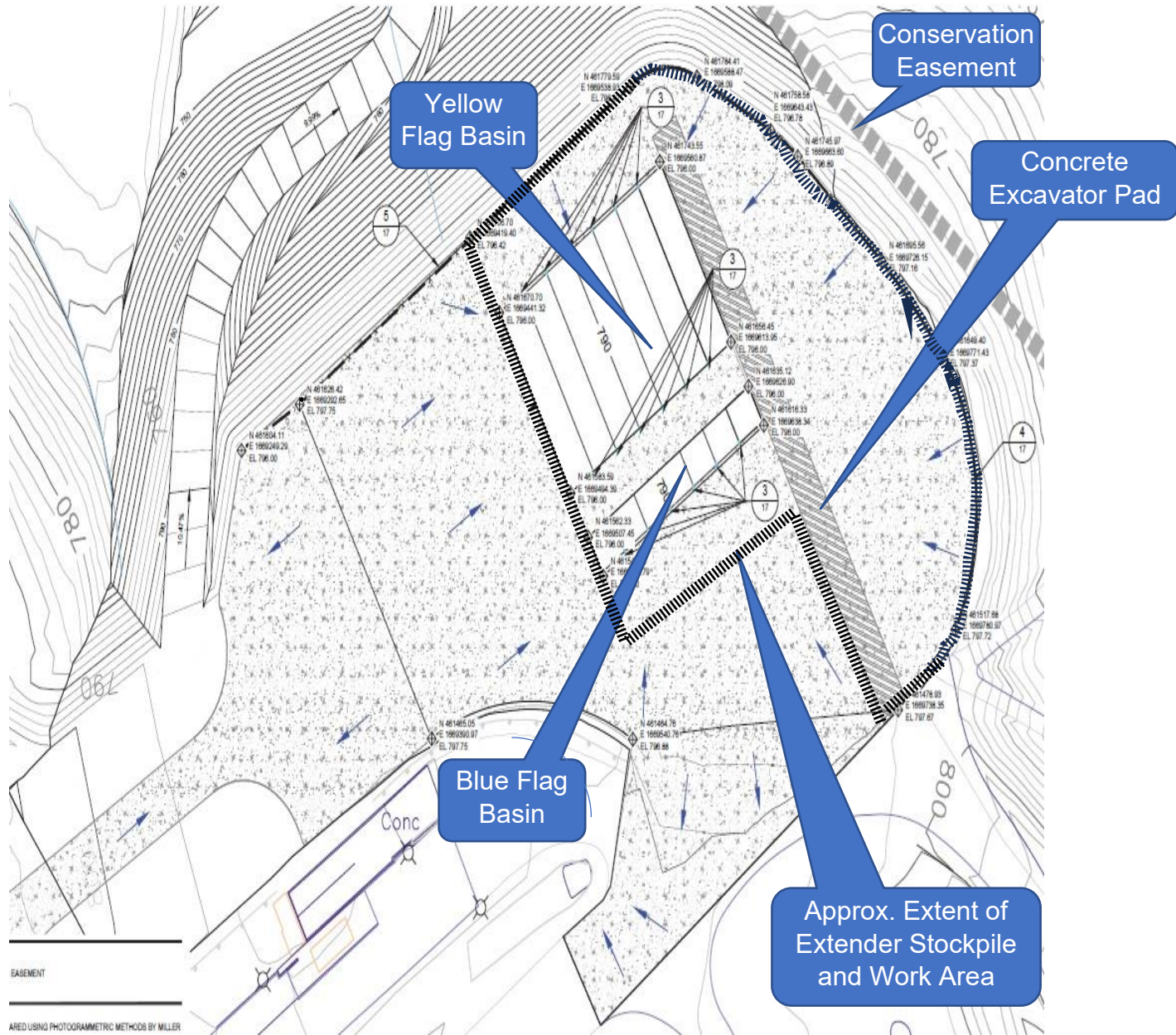

Proposed Asphalt Concrete Grading Plan, annotated excerpt, ROWD Revision 1, Drawing 15, 30 June 2022, NTS

ATTACHMENT D—DOCUMENTED GEOLOGIC FEATURES

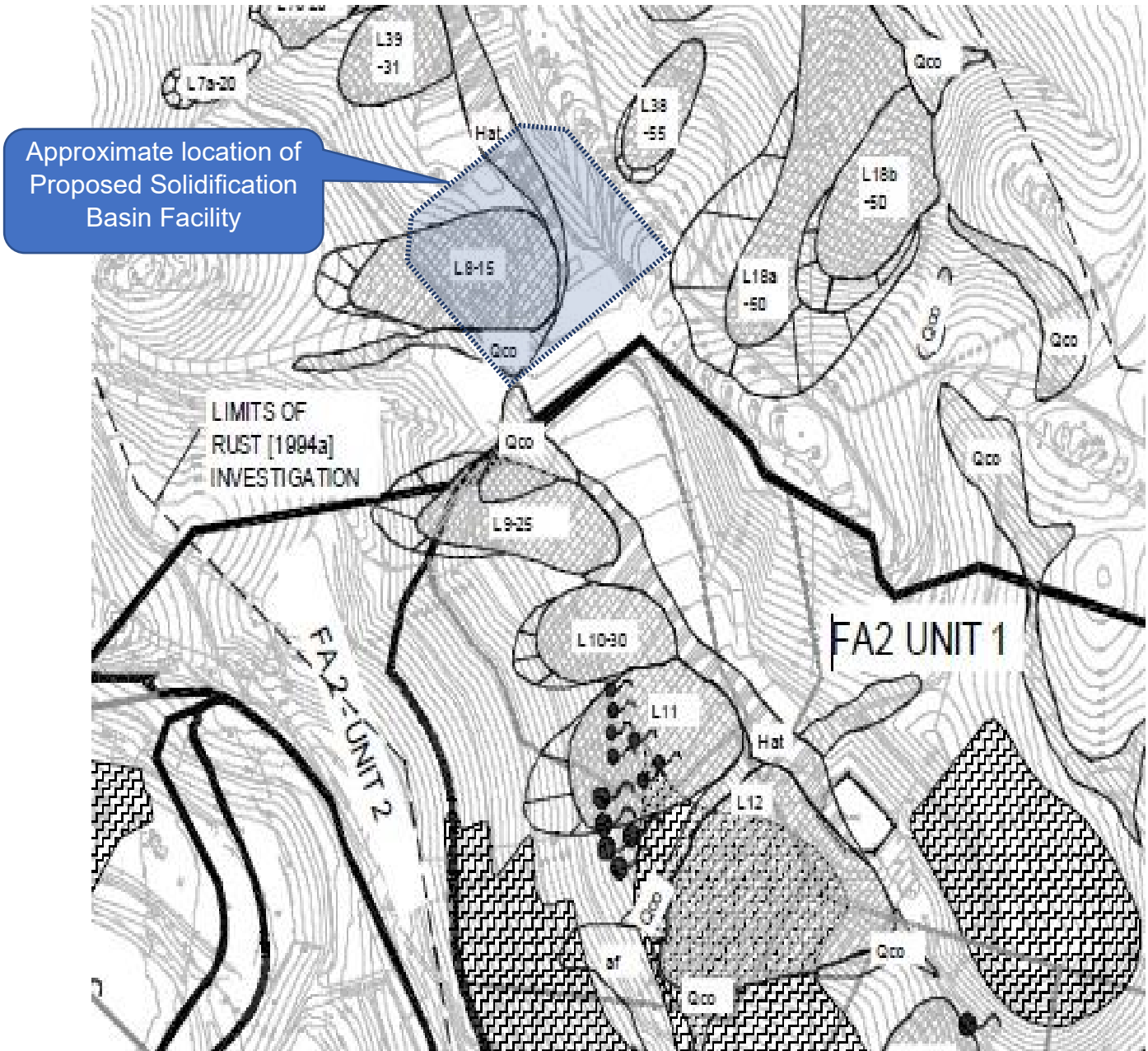

Site Geologic Hazards, Shallow Groundwater, Documented Seeps/Springs,
Excerpt from WDRs Order No. R5-2016-0042, Attachment G, NTS

ATTACHMENT E—FAULT ZONE MAP

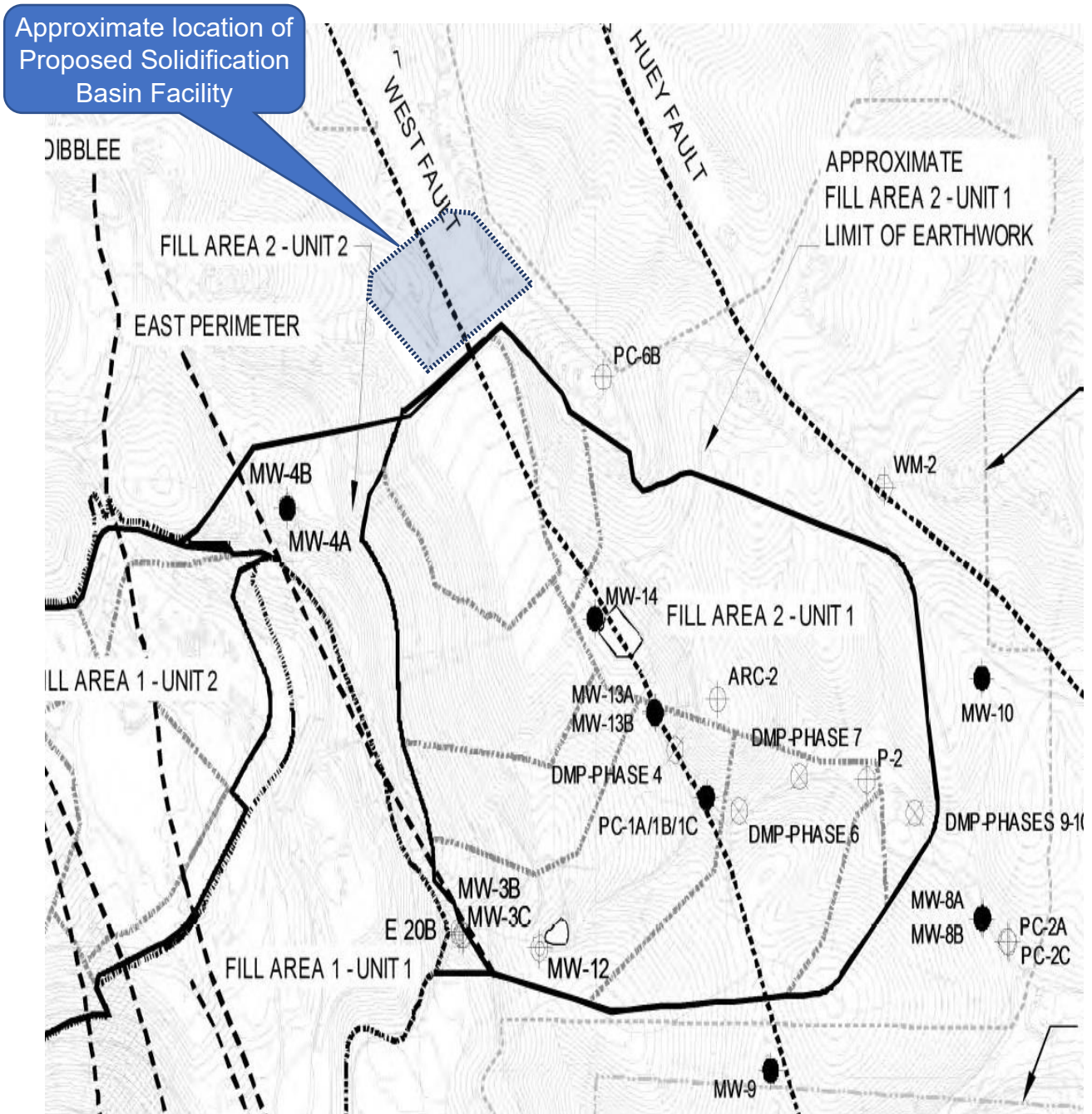

Excerpt from WDRs Order No. R5-2016-0042, Attachment D, NTS

ATTACHMENT F—PROPOSED BASIN CROSS SECTIONS

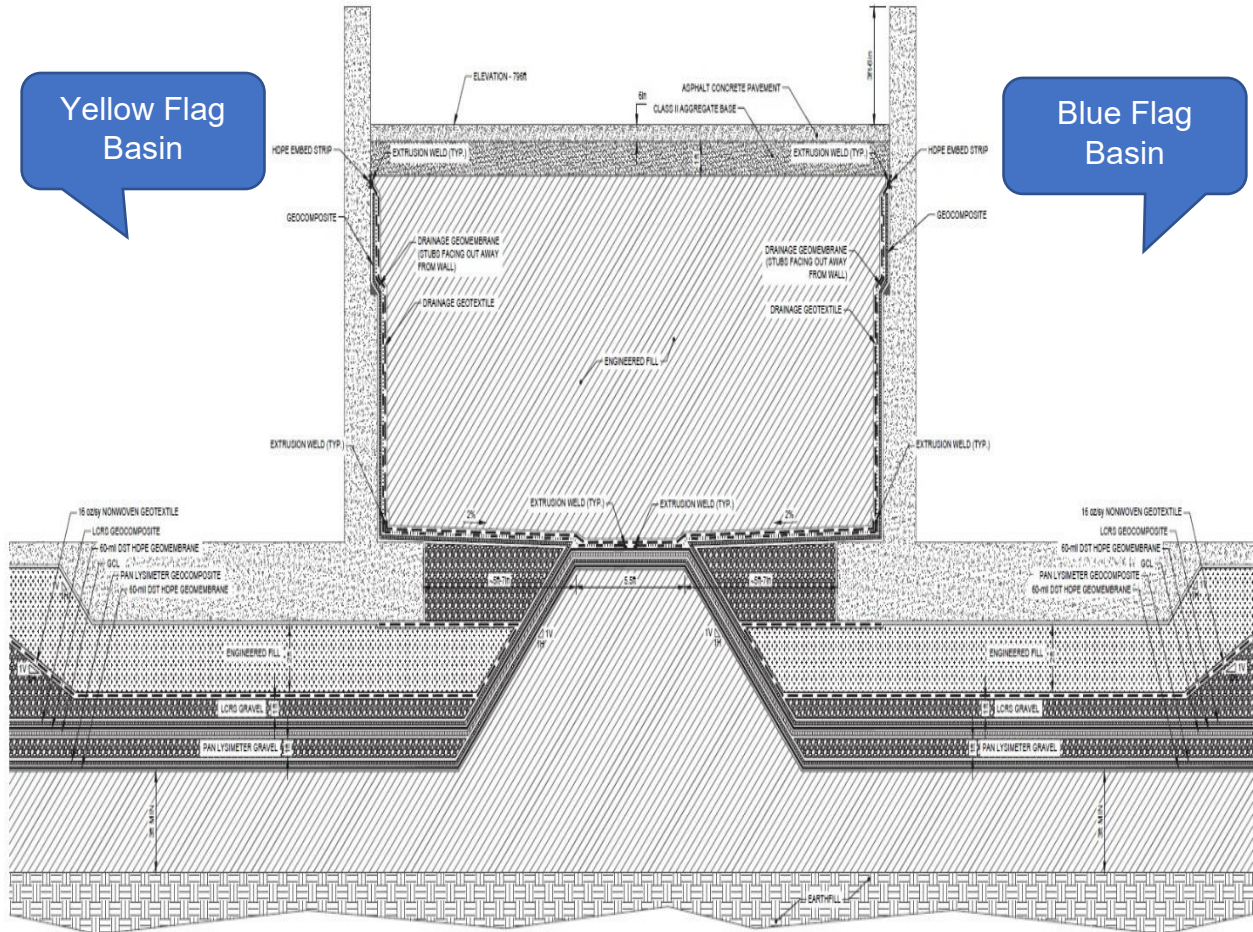

- NOTE(S)
1. SEE STRUCTURAL DRAWINGS FOR DETAILED DESIGN OF THE CONCRETE AND BASINS.
 2. GEOSYNTHETICS ENLARGED FOR CLARITY.
 3. ENGINEERED FILL PLACED WITHIN 12 INCHES OF THE HDPE GEOMEMBRANE SHALL HAVE A MAXIMUM PARTICLE SIZE OF 1/2 INCH.

SCALE 1"=2'-0" **A** TYPICAL LINER SECTION - FLOOR
 10

Typical Proposed Basin Cross Section, ROWD Revision 1, 30 June 2022, NTS

ATTACHMENT G—PROPOSED ACCESS RAMP CROSS SECTION

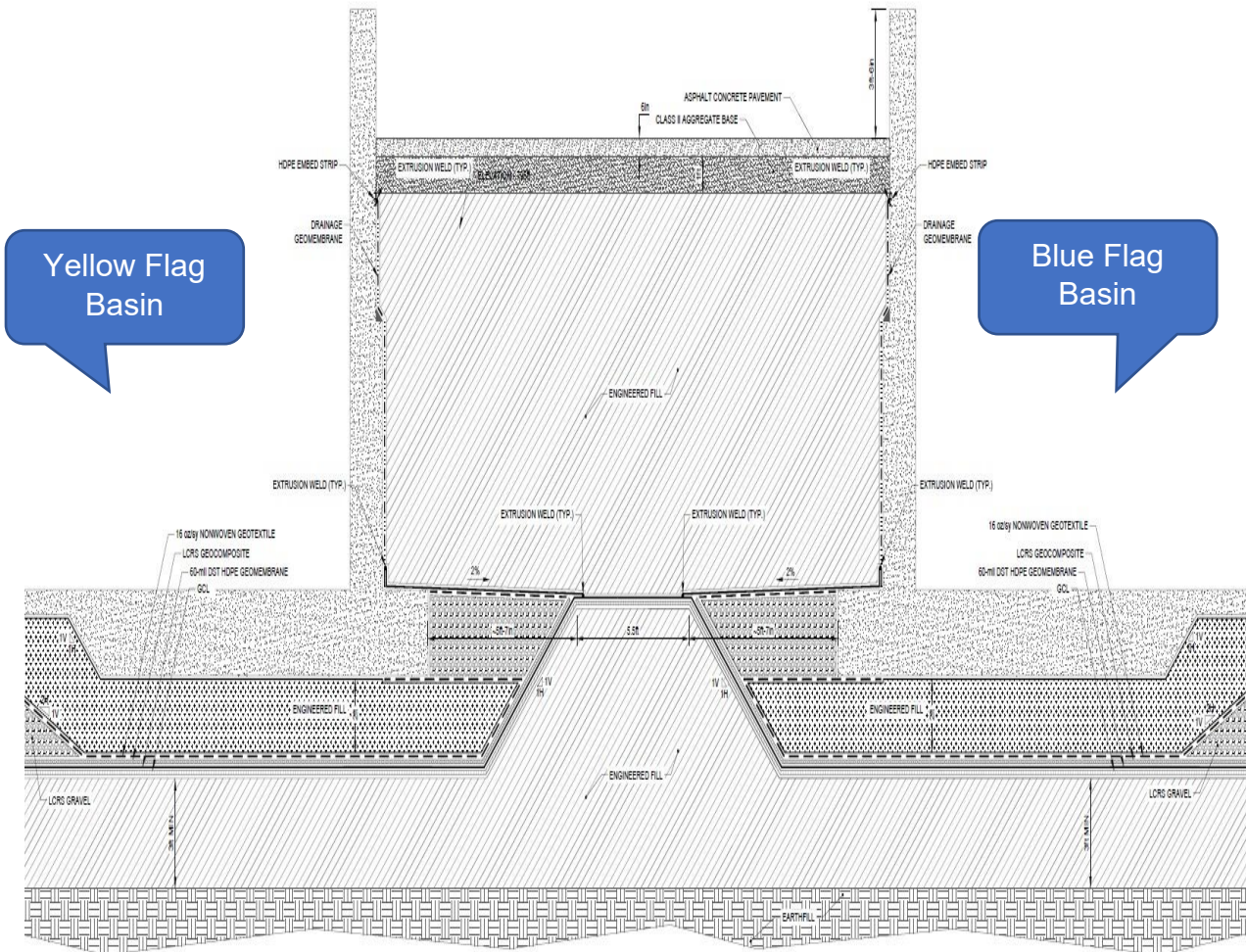

Typical Proposed Basin Cross Section, ROWD Revision 1, 30 June 2022, NTS

ATTACHMENT H—PROPOSED LCRS AND PAN LYSIMETER

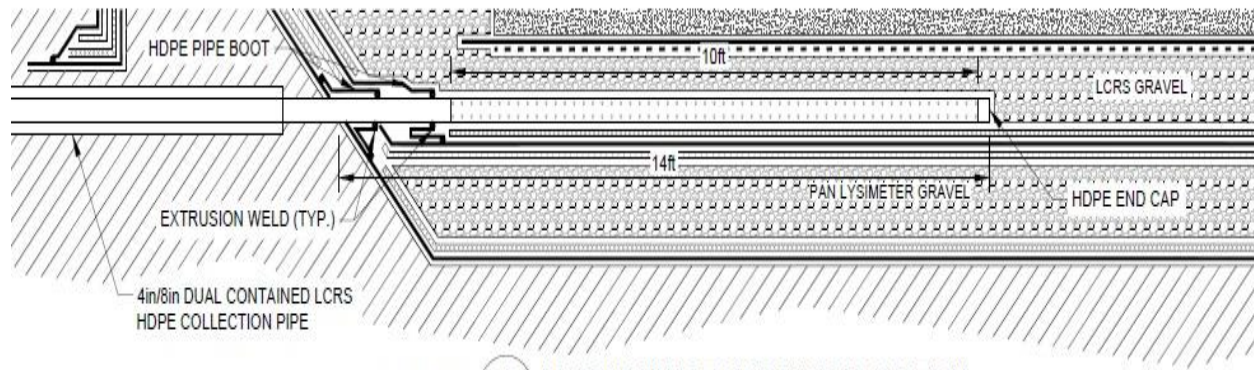

SCALE N.T.S. **1** LCRS DRAINAGE PIPE TYPICAL SECTION
3

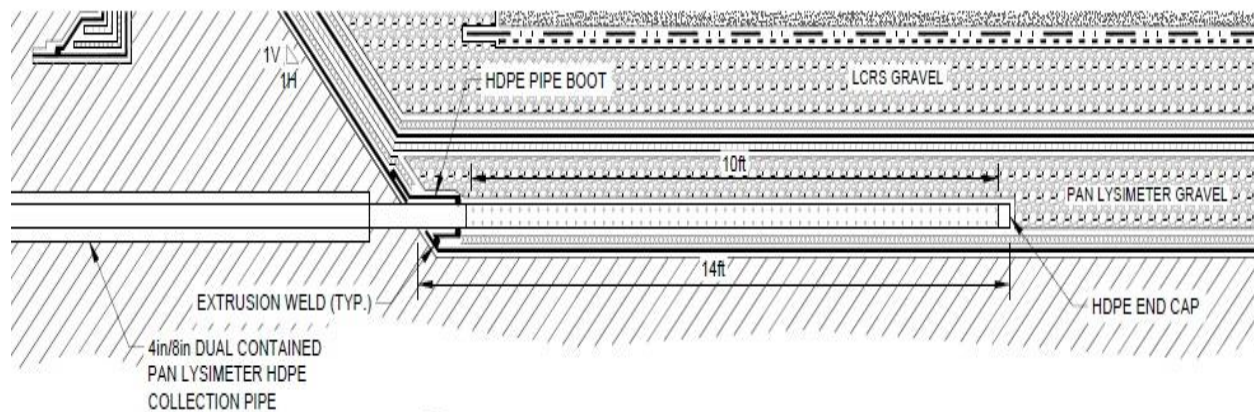

SCALE N.T.S. **2** PAN LYSIMETER DRAINAGE PIPE TYPICAL SECTION
3

Typical Proposed LCRS and Pan Lysimeter Design Detail, ROWD Revision 1, 30 June 2022, NTS

ATTACHMENT I—LEACHATE STORAGE TANKS

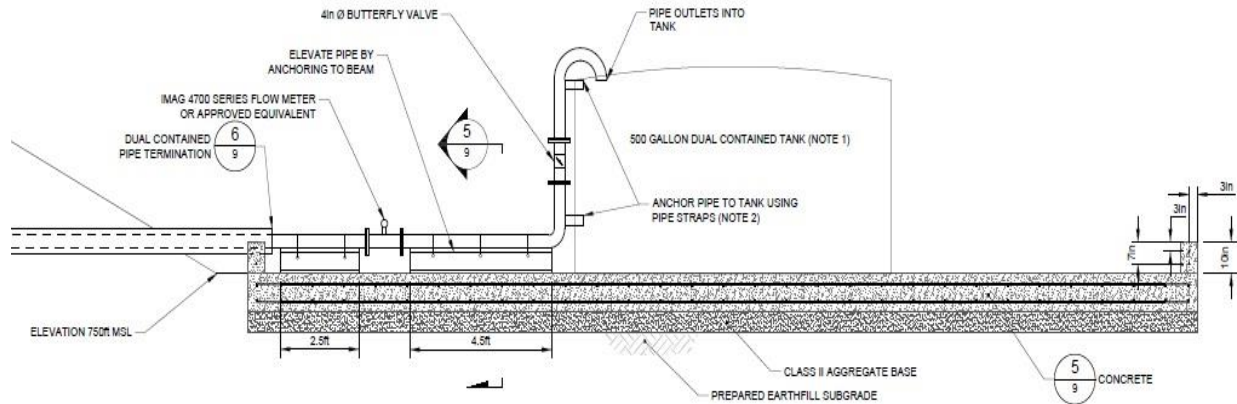

SCALE 1"=2' 1 TYPICAL LYSIMETER PIPING AND TANK

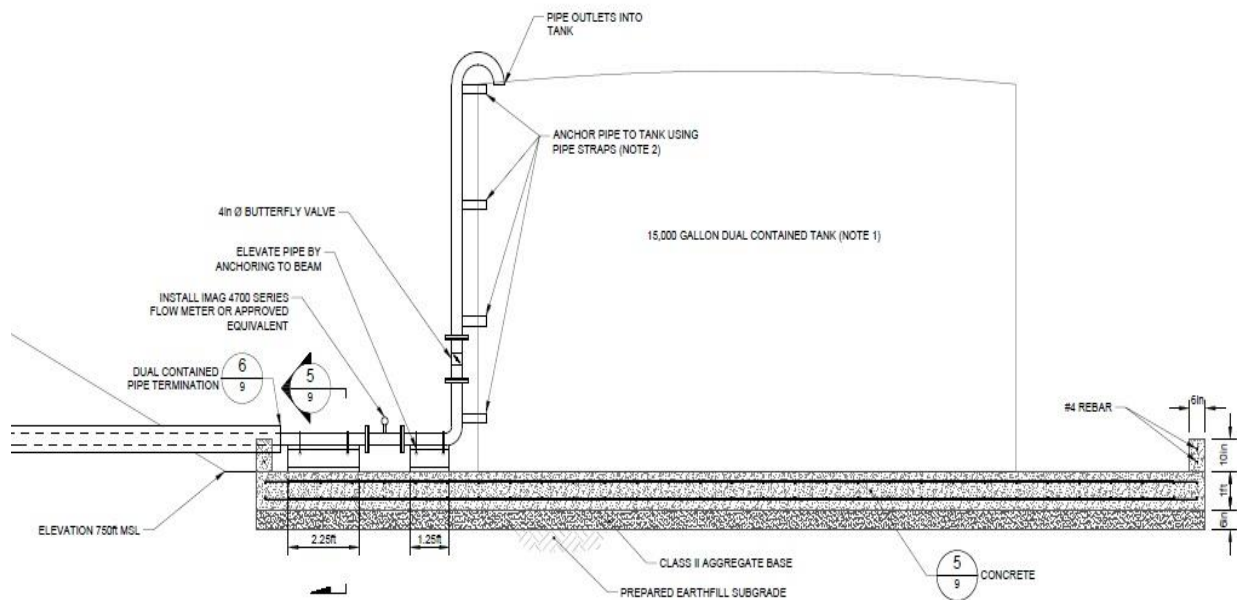

SCALE 1"=2' 2 TYPICAL LEACHATE PIPING AND TANK

Proposed Leachate Storage Tank Details, ROWD Revision 1, 30 June 2022, NTS

ATTACHMENT J—PROPOSED EXTENDER STOCKPILE AND WORK AREA DETAILS

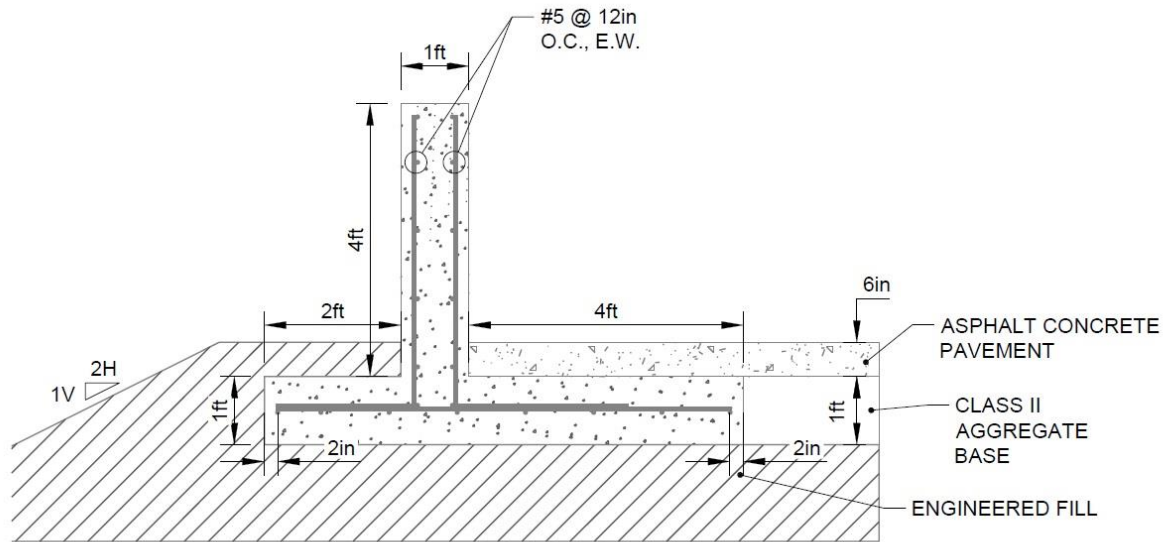

SCALE N.T.S.

4
3

EXTENDER CONCRETE CONTAINMENT WALL TYPICAL DETAIL

Order—Normal Text

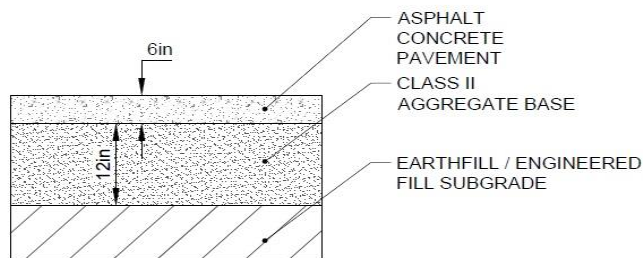

SCALE 1"=2'

3
9

TYPICAL ASPHALT SURFACE DETAIL

Excerpt of Proposed Design Details, ROWD Revision 1, 30 June 2022, NTS. (Modified design to include 1-foot of clay liner (1E-06 cm/sec) below the asphalt concrete pavement section)

ATTACHMENT K—1996 EIR PROJECT AREA

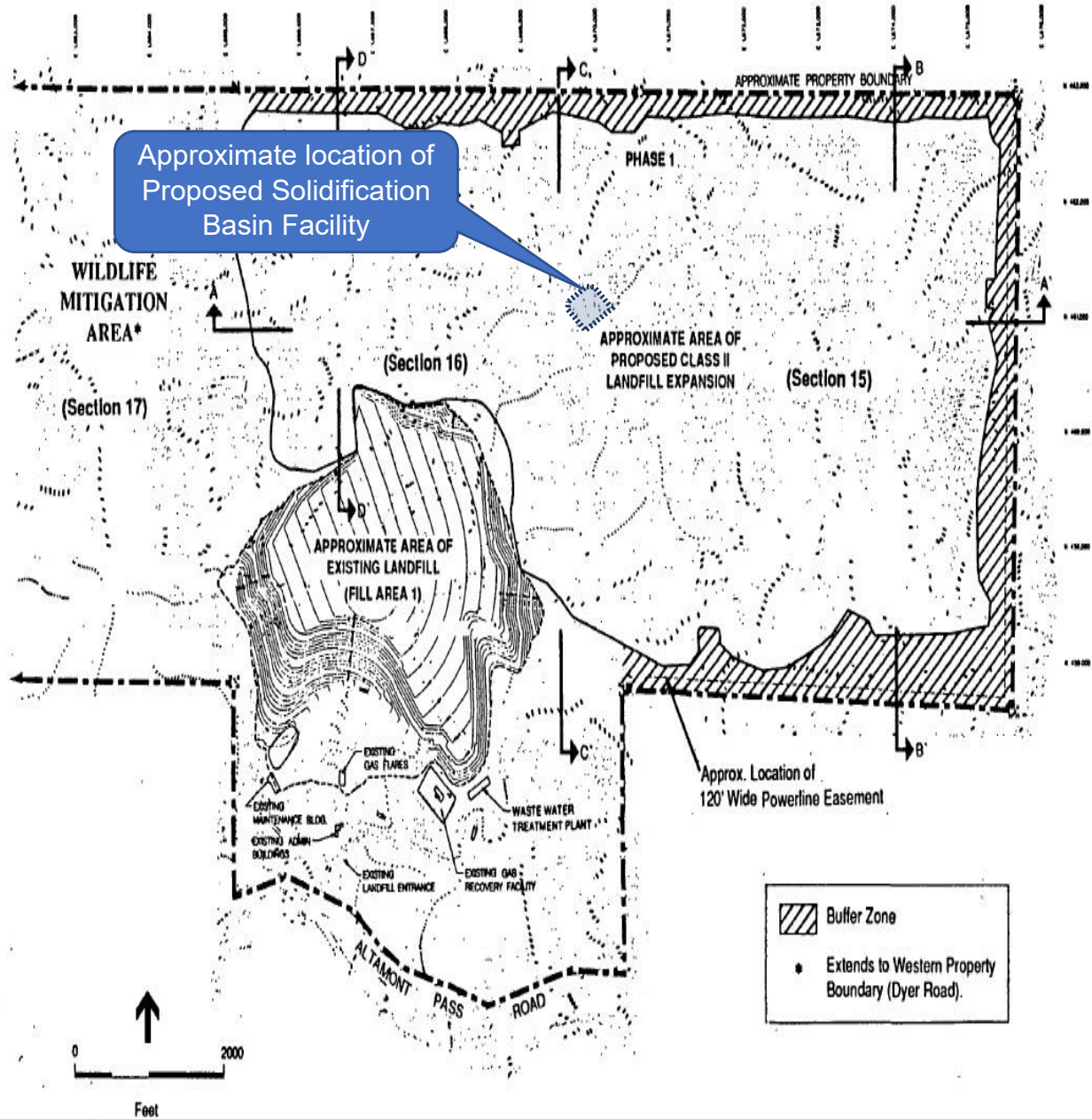

Altamont Class II Expansion EIR 1920070, Figure II-2

STANDARD PROVISIONS & REPORTING REQUIREMENTS

Non-Hazardous Discharges of Waste Regulated under Subtitle D and/or Title 27, December 2015 Edition

A. Applicability

1. These Standard Provisions and Reporting Requirements (SPRRs) are applicable to nonhazardous solid waste disposal sites that are regulated by the Central Valley Regional Water Quality Control Board (hereafter, Central Valley Water Board) pursuant to the provisions of California Code of Regulations, Title 27 ("Title 27"), section 20005 et seq., and municipal solid waste (MSW) landfills that are subject to the Federal Subtitle D regulations contained in 40 Code of Federal Regulations section 258 (hereafter, "Subtitle D" or "40 C.F.R. § 258.XX") in accordance with State Water Resources Control Board (State Water Board) Resolution 93-62. The Subtitle D regulations are only applicable to MSW landfills and therefore any requirements in these SPRRs that are referenced as coming from Subtitle D are not applicable to non-MSW waste management units such as Class II surface impoundments, Class II waste piles, and non-MSW landfill units. All Subtitle D requirements in these SPRRs are referenced with "[40 C.F.R. § 258.XX]" after the requirement.
2. "Order," as used throughout this document, means the Waste Discharge Requirements (WDRs) to which these SPRRs are incorporated.
3. The requirements prescribed herein do not authorize the commission of any act causing injury to the property of another, and do not protect the Discharger from liabilities under federal, state, or local laws. This Order does not convey any property rights or exclusive privileges.
4. The provisions of this Order are severable. If any provision of this Order is held invalid, the remainder of this Order shall not be affected.
5. If there is any conflicting or contradictory language between the WDRs, the Monitoring and Reporting Program (MRP), or the SPRRs, then language in the WDRs shall govern over either the MRP or the SPRRs, and language in the MRP shall govern over the SPRRs.
6. If there is a site-specific need to change a requirement in these SPRRs for a particular landfill facility, the altered requirement shall be placed in the appropriate section of the WDRs and will supersede the corresponding SPRRs requirement. These SPRRs are standard and cannot be changed as part of the permit writing process or in response to comments, but they will be periodically updated on an as-needed basis.

7. Unless otherwise stated, all terms are as defined in Water Code section 13050 and in Title 27, section 20164.

B. Terms and Conditions

1. Failure to comply with any waste discharge requirement, monitoring and reporting requirement, or Standard Provisions and Reporting Requirement, or other order or prohibition issued, reissued, or amended by the Central Valley Water Board or the State Water Board, or intentionally or negligently discharging waste, or causing or permitting waste to be deposited where it is discharged into the waters of the state and creates a condition of pollution or nuisance, is a violation of this Order and the Water Code, which can result in the imposition of civil monetary liability [Wat. Code, § 13350(a)]
2. After notice and opportunity for a hearing, this Order may be terminated or modified for cause, including, but not limited to [Wat. Code, § 13381]:
 - a. Violation of any term or condition contained in this Order;
 - b. Obtaining this Order by misrepresentation, or failure to disclose fully all relevant facts;
 - c. A change in any condition that results in either a temporary or permanent need to reduce or eliminate the authorized discharge; or
 - d. A material change in the character, location, or volume of discharge.
3. Before initiating a new discharge or making a material change in the character, location, or volume of an existing discharge, the Discharger shall file a new report of waste discharge (ROWD), or other appropriate joint technical document (JTD), with the Central Valley Water Board [Wat. Code, § 13260(c) and § 13264(a)]. A material change includes, but is not limited to, the following:
 - a. An increase in area or depth to be used for solid waste disposal beyond that specified in waste discharge requirements;
 - b. A significant change in disposal method, location, or volume (e.g., change from land disposal to land treatment);
 - c. A change in the type of waste being accepted for disposal; or

STANDARD PROVISIONS & REPORTING REQUIREMENTS

- d. A change to previously-approved liner systems or final cover systems that would eliminate components or reduce the engineering properties of components.
4. Representatives of the Central Valley Water Board may inspect the facilities to ascertain compliance with the waste discharge requirements. The inspection shall be made with the consent of the owner or possessor of the facilities or, if the consent is refused, with a duly issued warrant. However, in the event of an emergency affecting the public health or safety, an inspection may be made without consent or the issuance of a warrant [Wat. Code, §13267(c)].
5. The Central Valley Water Board will review this Order periodically and will revise these waste discharge requirements when necessary [Wat. Code, § 13263(e) and Title 27, § 21720(b)].
6. Except for material determined to be confidential in accordance with California law and regulations, all reports prepared in accordance with terms of this Order shall be available for public inspection at the offices of the Central Valley Water Board [Wat. Code, § 13267(b)]. Data on waste discharges, water quality, geology, and hydrogeology shall not be considered confidential.
7. A discharge of waste into the waters of the state is a privilege, not a right. No discharge of waste into waters of the state, whether or not the discharge is made pursuant to waste discharge requirements, shall create a vested right to continue the discharge [Wat. Code, § 13263(g)].
8. Technical and monitoring reports specified in this Order are requested pursuant to the Water Code [§13267(b)]. Failure to furnish the reports by the specified deadlines or falsifying information in the reports, are misdemeanors that may be liable civilly in accordance with §13268(b) of the Water Code [Wat. Code, §13268(a)].

C. Standard Prohibitions

1. The discharge of liquid or semi-solid waste (waste containing less than 50 percent solids) is prohibited, except for the following when proposed in the ROWD/JTD and approved by this Order:
 - a. Dewatered sewage or water treatment sludge as described in Title 27, section 20220(c) provided it is discharged above a composite liner with a leachate collection and removal system (LCRS) [Title 27, § 20200(d)(3)].

- b. Leachate and/or landfill gas condensate that is returned to the composite- lined waste management unit (with an LCRS) from which it came [Title 27, § 20340(g) and 40 C.F.R. § 258.28].
- 2. The discharge of wastes which have the potential to reduce or impair the integrity of containment structures or which, if commingled with other wastes in the waste management unit, could produce violent reaction, heat or pressure, fire or explosion, toxic by-products, or reaction products, which, in turn:
 - a. require a higher level of containment than provided by the unit; or
 - b. are 'restricted wastes'; or
 - c. impair the integrity of containment structures; is prohibited [Title 27, § 20200(b)].
- 3. The discharge of wastes outside of a waste management unit or portions of a unit specifically designed for their containment is prohibited.
- 4. The discharge of solid waste containing free liquid or which may contain liquid in excess of the moisture holding capacity as a result of waste management operations, compaction or settlement is prohibited.
- 5. The discharge of waste to a closed landfill unit is prohibited.
- 6. The discharge of waste constituents to the unsaturated zone or to groundwater is prohibited.
- 7. The discharge of solid or liquid waste or leachate to surface waters, surface water drainage courses, or groundwater is prohibited.

D. Standard Discharge Specifications

- 1. The Discharger is responsible for accurate characterization of wastes, including a determination of whether or not wastes will be compatible with containment features and other wastes at the waste management unit and whether or not the wastes are required to be managed as a hazardous waste [Title 27, § 20200(c)] or designated waste [Title 27, § 20210].
- 2. Leachate and landfill gas condensate collected from a waste management unit shall be discharged to the unit from which it came, or discharged to an appropriate waste management unit in accordance with Title 27 and in a

STANDARD PROVISIONS & REPORTING REQUIREMENTS

manner consistent with the waste classification of the liquid [Title 27, § 20200(d) and § 20340(g)].

3. The discharge of leachate or landfill gas condensate is restricted to those portions of a waste management unit that has a composite liner system and LCRS meeting the Federal Subtitle D requirements [40 C.F.R. § 258.28].
4. Leachate and condensate returned to a composite-lined landfill unit (when approved by this Order) shall be discharged and managed such that it does not cause instability of the waste, does not cause leachate seeps, does not generate additional landfill gas that is not extracted from the landfill by an active landfill gas extraction system, does not cause contaminants to enter surface water runoff, and does not cause leachate volumes to exceed the maximum capacity of the LCRS.
5. Any discharge of waste outside the portion of the landfill that was already covered with waste as of the landfill unit's respective Federal Deadline constitutes a "lateral expansion" and requires the installation of an approved composite liner system and LCRS [40 C.F.R. § 258.40(b)].
6. Wastes shall be discharged only into waste management units specifically designed for their containment and/or treatment, as described in this Order.
7. The discharge shall remain within the designated disposal area at all times.
8. The discharge of waste shall not cause a nuisance condition [Wat. Code, § 13050(m)].

E. Standard Facility Specifications

1. All waste management units shall be designed, constructed, and operated to ensure that wastes, including leachate, will be a minimum of 5 feet above the highest anticipated elevation of underlying groundwater [Title 27, § 20240(c)], including the capillary fringe.
2. Surface and subsurface drainage from outside of a waste management unit shall be diverted from the unit [Title 27, § 20365(e)].
3. Interim cover is daily and intermediate cover [Title 27, § 20750(a)]. Interim cover over wastes discharged to a landfill shall be designed and

STANDARD PROVISIONS & REPORTING REQUIREMENTS

- constructed to minimize percolation of liquids through the wastes [Title 27, § 20705(b)].
4. Intermediate cover consisting of compacted earthen material of at least twelve (12) inches shall be placed on all surfaces of the fill where no additional solid waste will be deposited within **180 days** [Title 27, § 20700(a)].
 5. During wet weather conditions, the facility shall be operated and graded to minimize leachate generation.
 6. The Discharger shall immediately notify the Central Valley Water Board staff of any slope failure occurring at a waste management unit. Any failure which threatens the integrity of containment features or the waste management unit shall be promptly corrected in accordance with an approved method [Title 27, § 21710(c)(2)].
 7. The Discharger shall **immediately** notify Central Valley Water Board staff of any flooding, unpermitted discharge of waste off-site or outside of waste management units, equipment failure, or other change in site conditions which could impair the integrity of waste or leachate containment facilities or precipitation and drainage control structures.
 8. The Discharger shall limit water used for facility maintenance within landfill areas to the minimum amount necessary for dust control and construction.
 9. The Discharger shall maintain in good working order any facility, control system, or monitoring device installed to achieve compliance with the waste discharge requirements.
 10. The Discharger shall lock all groundwater monitoring wells with a lock on the well cap or monitoring well box. All monitoring devices shall be clearly labeled with their designation including all monitoring wells, LCRS risers, and lysimeter risers and shall be easily accessible for required monitoring by authorized personnel. Each monitoring device shall be clearly visible and be protected from damage by equipment or vehicles.
 11. The Discharger shall ensure that methane and other landfill gases are adequately vented, removed from landfill units, or otherwise controlled to prevent the danger of adverse health effects, nuisance conditions, degradation, or the impairment of the beneficial uses of surface water or groundwater due to migration through the unsaturated zone.

STANDARD PROVISIONS & REPORTING REQUIREMENTS

12. The Discharger shall maintain the depth of the fluid in the sump of each landfill unit at the minimum needed for efficient pump operation (the depth at which the pump turns on given the pump intake height and maximum pump cycle frequency).
13. The depth of fluid on the landfill liner shall not exceed **30 centimeters** (cm) [40 C.F.R. § 258.40(a)(2)]. This regulation is interpreted by the Central Valley Water Board to exclude the leachate sump. The Discharger shall **immediately** notify the Central Valley Water Board staff by telephone, and follow up in writing within **seven** days if monitoring reveals that the depth of fluid on any portion of the liner (excluding the sump) exceeds 30 cm (approximately 12 inches). The written notification shall include a timetable for remedial or corrective action necessary to achieve compliance with the leachate depth limitation.
14. Each LCRS shall be tested at least annually to demonstrate proper operation. The results of the tests shall be compared with earlier tests made under comparable conditions [Title 27, § 20340(d)].
15. The Discharger shall maintain a *Storm Water Pollution Prevention Plan and Monitoring Program and Reporting Requirements* in accordance with State Water Board Order No. 2014-0057-DWQ (Industrial General Permit) or most recent general industrial storm water permit), or retain all storm water on-site.
16. Internal site drainage from surface or subsurface sources shall not contact or percolate through wastes.
17. New MSW landfill units or lateral expansions of existing units shall not be sited in a “wetland” [as defined in 40 C.F.R. § 232.29(r)] unless there is no practical alternative; steps have been taken to assure no net loss of wetland; the landfill unit will not degrade the wetland; the unit will not jeopardize threatened or endangered species or produce adverse modification of a critical habitat or violate any requirement of the Marine Protection, Research, and Sanctuaries Act of 1972 [40 C.F.R. § 258.12].

F. Standard Construction Specifications

1. The Discharger shall submit for review and approval at least 90 days prior to proposed construction, design plans and specifications for new landfill modules that include the following:
 - a. Detailed construction drawings showing all required liner system components, the LCRS, leachate sump, unsaturated zone

- monitoring system, any proposed landfill gas monitoring and extraction points, and access to the LCRS for required annual testing.
- b. A Construction Quality Assurance (CQA) Plan prepared by a California-registered civil engineer or certified engineering geologist, and that meets the requirements of Title 27, section 20324.
 - c. A geotechnical evaluation of the area soils, evaluating their use as the base layer or reference to the location of this information in the ROWD/JTD [Title 27, § 21750(f)(4)].
 - d. Information about the seismic design of the proposed new module (or reference to the location of this information in the ROWD/JTD) in accordance with Title 27, section 20370.
 - e. A revised water quality monitoring plan for groundwater detection monitoring (or information showing the existing plan is adequate) in accordance with Title 27, section 20415.
 - f. An Operation Plan (or reference to the location of this information in the ROWD/JTD) meeting the requirements of Title 27, section 21760(b).
2. All containment structures shall be designed by, and construction shall be supervised by, a California registered civil engineer or a certified engineering geologist, and shall be certified by that individual as meeting the prescriptive standards, or approved engineered alternative design, in accordance with this Order prior to waste discharge.
 3. The Discharger shall not proceed with construction until the construction plans, specifications, and all applicable construction quality assurance plans have been approved. Waste management units shall receive a final inspection and approval of the construction by Central Valley Water Board staff before use of the unit commences [Title 27, § 20310(e)].
 4. Any report, or any amendment or revision of a report, that proposes a design or design change that might affect a waste management unit's containment features or monitoring systems shall be approved by a California registered civil engineer or a certified engineering geologist [Title 27, § 21710(d)].

STANDARD PROVISIONS & REPORTING REQUIREMENTS

5. Materials used in containment structures shall have appropriate chemical and physical properties to ensure that such structures do not fail to contain waste because of pressure gradients, physical contact with waste or leachate, chemical reactions with soil or rock, climatic conditions, the stress of installation, or because of the stress of daily operations [Title 27, § 20320(a)].
6. Waste management units and their respective containment structures shall be designed and constructed to limit, to the greatest extent possible, ponding, infiltration, inundation, erosion, slope failure, washout, and overtopping [Title 27, § 20365(a)].
7. The Discharger shall design storm water conveyance systems for Class III units for a 100-year, 24-hour storm event, and shall design storm water conveyance systems for Class II units for a 1,000-year, 24-hour storm event [Title 27, § 21750(e)(3)].
8. All Class III landfill units shall be designed to withstand the maximum probable earthquake and Class II waste management units shall be designed to withstand maximum credible earthquake without damage to the foundation or to the structures that control leachate, or surface drainage, or erosion, or gas [Title 27, § 20370(a)].
9. The Discharger shall perform stability analyses that include components to demonstrate the integrity of the landfill foundation, final slopes, and containment systems under both static and dynamic conditions throughout the landfill's life including the closure period and post-closure maintenance period [Title 27, § 21750(f)(5)].
10. New waste management units and expansions of existing units shall not be located on a known Holocene fault [Title 27, § 20260(d)].
11. Liners shall be designed and constructed to contain the fluid, including landfill gas, waste, and leachate [Title 27, § 20330(a)].
12. Hydraulic conductivities shall be determined primarily by appropriate field test methods in accordance with accepted civil engineering practice. The results of laboratory tests with both water and leachate, and field tests with water, shall be compared to evaluate how the field permeabilities will be affected by leachate. It is acceptable for the Discharger to use appropriate compaction tests in conjunction with laboratory hydraulic conductivity tests to determine field permeabilities as long as a reasonable number of field hydraulic conductivity tests are also conducted [Title 27, § 20320(c)].

STANDARD PROVISIONS & REPORTING REQUIREMENTS

13. Hydraulic conductivities specified for containment structures other than the final cover shall be relative to the fluids (leachate) to be contained. Hydraulic conductivities for the final cover shall be relative to water [Title 27, § 20320(b)].
14. A test pad for each barrier layer and final cover shall be constructed in a manner duplicating the field construction. Test pad construction methods, with the designated equipment, shall be used to determine if the specified density/moisture-content/hydraulic conductivity relationships determined in the laboratory can be achieved in the field with the compaction equipment to be used and at the specified lift thickness [Title 27, § 20324(g)(1)(A)].
15. Performance requirements for geosynthetic membranes shall include, but are not limited to, a need to limit infiltration of water, to the greatest extent possible; a need to control landfill gas emissions; mechanical compatibility with stresses caused by equipment traffic, and for final covers the result of differential settlement over time and durability throughout the post-closure maintenance period [Title 27, § 20324(i)(1)].
16. The Discharger shall ensure proper preparation of the subgrade for any liner system that includes a GCL so as to provide a smooth surface that is free from rocks, sticks, or other debris that could damage or otherwise limit the performance of the GCL.
17. The Discharger shall propose an electronic leak location survey of the top liner for any new landfill module in the construction quality assurance plan unless the Discharger demonstrates that a leak location survey is not needed.
18. Leachate collection and removal systems are required for Class II landfills and surface impoundments, MSW landfills, and for Class III landfills which have a liner or which accept sewage or water treatment sludge [Title 27, § 20340(a)].
19. All new landfill units or lateral expansions of existing units that require a LCRS shall have a blanket-type LCRS that covers the bottom of the unit and extends as far up the sides as possible. The LCRS shall be of sufficient strength and thickness to prevent collapse under the pressures exerted by overlying wastes, waste cover materials, and by any equipment used at the unit [Title 27, § 20340(e)].
20. The LCRS shall be designed, constructed, maintained, and operated to collect and remove twice the maximum anticipated daily volume of leachate from the waste management unit [Title 27, § 20340(b)].

STANDARD PROVISIONS & REPORTING REQUIREMENTS

21. Leachate collection and removal systems shall be designed and operated to function without clogging through the scheduled closure of the landfill unit and during the post-closure maintenance period.
22. The LCRS shall be designed to maintain the depth of fluid over any portion of the LCRS of no greater than 30 cm [40 C.F.R. § 258.40(a)(2)], excluding the leachate sump. The leachate sump, leachate removal pump, and pump controls shall be designed and set to maintain a fluid depth no greater than the minimum needed for efficient pump operation [Title 27, § 20340(c)].
23. All construction of liner systems and final cover systems shall be performed in accordance with a Construction Quality Assurance Plan certified by a registered civil engineer or a certified engineering geologist [Title 27, § 20323].
24. The Construction Quality Assurance program shall be supervised by a registered civil engineer or a certified engineering geologist who shall be designated the CQA officer [Title 27, § 20324(b)(2)].
25. The Discharger shall ensure that a third party independent of both the Discharger and the construction contractor performs all of the construction quality assurance monitoring and testing during the construction of a liner system.
26. The Discharger shall notify Central Valley Water Board staff at least **14 days** prior to commencing field construction activities including construction of a new lined cell or module, construction of a final cover, or any other construction that requires Central Valley Water Board staff approval under this Order.
27. The Discharger shall submit for review and approval at least **60 days** prior to proposed discharge, final documentation required in Title 27 Section 20324(d)(1)(C) following the completion of construction of a new lined landfill module. The report shall be certified by a registered civil engineer or a certified engineering geologist and include a statement that the liner system was constructed in accordance with the approved design plans and specifications, the CQA Plan, the requirements of the WDRs, and that it meets the performance goals of Title 27. The report shall contain sufficient information and test results to verify that construction was in accordance with the design plans and specifications, the construction quality assurance plan, and the performance goals of Title 27.

STANDARD PROVISIONS & REPORTING REQUIREMENTS

28. The Discharger shall not discharge waste onto a newly constructed liner system until the final documentation report has been reviewed and an acceptance letter has been received.
29. Prior to placement of waste in a new landfill unit, the Discharger shall monitor any pan lysimeter for the unit that has received enough rainfall to flood the LCRS sump. If liquid is detected in the pan lysimeter, the Discharger shall verify that the liquid is not from a leak in the primary liner system before waste can be accepted to the new module.

G. Standard Closure and Post-Closure Specifications

1. The Discharger shall submit a final or partial final closure and post-closure maintenance plan at least **two years** prior to the anticipated date of closure [Title 27, § 21780(d)(1)].
2. The Discharger shall notify the Central Valley Water Board in writing that a landfill unit or portion of a unit is to be closed either at the same time that the California Department of Resources Recycling and Recovery (CalRecycle) is notified or **180 days** prior to beginning any final closure activities, whichever is sooner [Title 27, § 21710(c)(5)(A)]. The notice shall include a statement that all closure activities will conform to the most recently approved final or partial final closure plan and that the plan provides for site closure in compliance with all applicable federal and state regulations [Title 27, § 21710(c)(5)(C)].
3. Initiation of closure activities shall begin within **30 days** of final waste receipt, or within one year of receipt of most recent waste if additional capacity remains [40 C.F.R. § 258.60(f)].
4. Closure activities shall be completed within **180 days** of the beginning of closure activities unless an extension is granted by the Central Valley Water Board [40 C.F.R. § 258.60(g)].
5. The Discharger shall carry out both mandatory closure and normal closure of a waste management unit or a portion of a unit in accordance with a closure and post-closure maintenance plan approved by the Central Valley Water Board [Title 27, § 20950(a)(1)] through the issuance of closure waste discharge requirements.
6. The Discharger shall notify the Central Valley Water Board that a preliminary closure and post-closure maintenance plan has been prepared and placed in the operating record by the date of initial receipt of waste at any new MSW landfill unit or lateral expansion of any existing unit [40

C.F.R. § 258.60(d)]. This notification shall be included in the cover letter transmitting the preliminary closure and post-closure maintenance plan.

7. In addition to the applicable provisions of Title 27, the preliminary closure and/or the post-closure maintenance plans for MSW landfill units shall include the following:
 - a. A description of the steps necessary to close all MSW landfill units at any point during their active life in accordance with the cover design requirements [40 C.F.R. § 258.60(c)];
 - b. An estimate of the largest area of the landfill unit(s) ever requiring a final cover at any time during the active life of the unit(s) [40 C.F.R. § 258.60(c)(2)];
 - c. An estimate of the maximum inventory of wastes ever on-site over the active life of the waste management facility [40 C.F.R. § 258.60(c)(3)]; and
 - d. A schedule for completing all activities necessary to satisfy the closure criteria in 40 C.F.R. section 258.60 [40 C.F.R. § 258.60(c)(4)].
8. The final closure and post-closure maintenance plan for the waste management unit shall include at least the following: an itemized cost analysis, closure schedule, any proposed final treatment procedures, map, changes to the unit description presented in the most recent ROWD, federal requirements for a MSW facility, land use of the closed unit, and a construction quality assurance plan [Title 27, § 21769(c) & (d)].
9. Closure of each waste management unit shall be under the direct supervision of a registered civil engineer or certified engineering geologist [Title 27, § 20950(b)].
10. The final cover of closed landfills shall be designed, graded, and maintained to prevent ponding and soil erosion due to high run-off velocities [Title 27, § 21090(b)(1)(A)].
11. The final grading design shall be designed and approved by a registered civil engineer or certified engineering geologist [Title 27, § 21090(b)(1)(C)].
12. All final cover designs shall include a minimum 1-foot thick erosion resistant layer [Title 27, § 21090(a)(3)(A)].

STANDARD PROVISIONS & REPORTING REQUIREMENTS

13. The Discharger shall close the landfill with minimum 15-foot wide benches every 50 vertical feet [Title 27, § 21090(a)].
14. Final cover slopes shall not be steeper than a horizontal to vertical ratio of one and three quarters to one and designs having any slopes steeper than a horizontal to vertical ratio of three to one, or having a geosynthetic component, shall have these aspects of their design specifically supported in the slope stability report required in Title 27, section 21750(f)(5) [Title 27, § 21090(a)].
15. For any portions of the final cover installed after July 18, 1997, for which the Central Valley Water Board has not approved a slope and foundation stability report on or before that date, the Discharger shall meet the requirements of Title 27, section 21750(f)(5) [Title 27, § 21090(a)(6)].
16. Areas with slopes greater than ten percent, surface drainage courses, and areas subject to erosion by wind or water shall be designed and constructed to prevent such erosion [Title 27, § 21090(b)(2)].
17. The Discharger shall design storm water conveyance systems for closed Class III units for a 100-year, 24-hour storm event, and shall design storm water conveyance systems for closed Class II units for a 1,000-year, 24-hour storm event [Title 27, § 21750(e)(3)].
18. Closed landfill units shall be provided with at least two permanent surveying monuments, installed by a licensed land surveyor or by a registered civil engineer, from which the location and elevation of all wastes, containment structures, and monitoring facilities can be determined throughout the post-closure maintenance period [Title 27, § 20950(d)].
19. Following closure of any MSW landfill units, the Discharger shall notify the Executive Officer that the deed to the landfill facility property, or some other instrument that is normally examined during a title search, has been recorded and a copy placed in the operating record. The notation on the deed shall in perpetuity notify any potential purchaser of the property that the land has been used as a landfill facility and that use of the land is restricted to the planned use described in the post-closure maintenance plan [Title 27, § 20515(a)(4) and §21170, and 40 C.F.R. § 258.60(i)].
20. Construction or repair of the final cover system's low-hydraulic conductivity layer is to be carried out in accordance with an approved construction quality assurance plan [Title 27, § 21090(b)(1)(E)].

STANDARD PROVISIONS & REPORTING REQUIREMENTS

21. The Discharger shall incorporate into the closure and post-closure maintenance plan a cover-integrity monitoring and maintenance program which includes at least the following: a periodic leak search, periodic identification of other problem areas, prompt cover repair, and vegetation maintenance [Title 27, § 21090(a)(4)].
22. The Discharger shall complete a final cover survey upon completion of closure activities for that portion of the landfill. The final cover surveys shall include an initial survey and map [Title 27, § 21090(e)(1). **Every five years**, the Discharger shall conduct a survey of the closed landfill cover and submit an iso-settlement map accurately depicting the estimated total change in elevation of each portion of the final cover's low-hydraulic-conductivity layer [Title 27, § 21090(e)(2)].
23. Within **30 days** of completion of all closure activities, the Discharger shall certify that all closure activities were performed in accordance with the most recently approved final closure plan and CQA Plan, and in accordance with all applicable regulations. The Discharger shall also certify that closed landfill units shall be maintained in accordance with and approved post-closure maintenance plan [Title 27, § 21710(c)(6)].
24. Within **180 days** of completion of closure construction activities, the Discharger shall submit final documentation of closure, including the Certification of Closure. The closure documents shall include a final construction quality assurance report and any other documents necessary to support the certification [Title 27, § 21880].
25. The post-closure maintenance period shall continue until the Central Valley Water Board determines that wastes remaining in the landfill unit(s) no longer pose a threat to water quality [Title 27, § 20950(a)(1)].
26. The Discharger shall conduct a periodic leak search to monitor of the integrity of the final cover in accordance with the schedule in the approved final post- closure maintenance plan [Title 27, § 21090(a)(4)(A)].
27. The Discharger shall periodically inspect and identify problems with the final cover including areas that require replanting, erosion, areas lacking free drainage, areas damaged by equipment operations, and localized areas identified in the required five-year iso-settlement survey [Title 27, § 21090(a)(4)(B)].
28. The Discharger shall repair the cover promptly in accordance with a cover repair plan to be included in the final post-closure maintenance plan [Title 27, § 21090(a)(4)(C)].

STANDARD PROVISIONS & REPORTING REQUIREMENTS

29. Throughout the post-closure maintenance period, the Discharger shall maintain the structural integrity and effectiveness of all containment structures, maintain the final cover as necessary to correct the effects of settlement and other adverse factors, continue to operate the LCRS as long as leachate is generated and detected, maintain the monitoring systems, prevent erosion and related damage of the final cover due to drainage, and protect and maintain surveyed monuments [Title 27, § 21090(c)].
30. Post-closure maintenance shall be conducted for a minimum period of 30 years or until the waste no longer poses a threat to environmental quality, whichever is greater [Title 27, § 21180(a) and Title 27, § 21900(a)].

H. Standard Financial Assurance Provisions

1. The Discharger shall establish an irrevocable fund for closure and post-closure maintenance to ensure closure and post-closure maintenance of each classified unit in accordance with an approved closure and post-closure maintenance plan [Title 27, § 20950(f) and § 22207(a)].
2. The Discharger shall obtain and maintain assurances of financial responsibility for initiating and completing corrective action for all known and reasonably foreseeable releases from the waste management unit [Title 27, §20380(b), § 22221, and § 22222].

I. Standard Monitoring Specifications

1. The water quality monitoring program shall include appropriate and consistent sampling and analytical procedures and methods designed to ensure that monitoring results provide a reliable indication of water quality at all monitoring points and background monitoring points [Title 27, § 20415(e)(4) and 40 C.F.R. § 258.53(b)].
2. All monitoring systems shall be designed and certified by a registered geologist or a registered civil engineer [Title 27, § 20415(e)(1)].
3. All monitoring wells shall be cased and constructed in a manner that maintains the integrity of the monitoring well bore hole and prevents the bore hole from acting as a conduit for contaminant transport [Title 27, § 20415(b)(4)(A)].
4. All sample chemical analyses of any material shall be performed by a laboratory certified by the California Department of Health Services [Wat. Code, § 13176(a)].

STANDARD PROVISIONS & REPORTING REQUIREMENTS

5. A Detection Monitoring Program for a new landfill facility shall be installed, operational, and one year of monitoring data collected from background monitoring points prior to the discharge of wastes [Title 27, § 20415(e)(6)].
6. Background for water samples or soil-pore gas samples shall be represented by the data from all samples taken from applicable background monitoring points during that reporting period (at least one sample from each background monitoring point).
7. The Discharger shall submit for approval, establish, and maintain an approved Sample Collection and Analysis Plan. The Sample Collection and Analysis Plan shall at a minimum include:
 - a. Sample collection procedures describing purging techniques, sampling equipment, and decontamination of sampling equipment;
 - b. Sample preservation information and shipment procedures;
 - c. Sample analytical methods and procedures;
 - d. Sample quality assurance/quality control (QA/QC) procedures;
 - e. Chain of Custody control; and
 - f. Sample analysis information including sample preparation techniques to avoid matrix interferences, method detection limits (MDLs), practical quantitation limits (PQLs) and reporting limits (RLs), and procedures for reporting trace results between the MDL and PQL.

If required by the Executive Officer, the Discharger shall modify the Sample Collection and Analysis Plan to conform with this Order.

8. For any given monitored medium, the samples taken from all monitoring points and background monitoring points to satisfy the data analysis requirements for a given reporting period shall all be taken **within a span not to exceed 30 days**, unless a longer time period is approved, and shall be taken in a manner that ensures sample independence to the greatest extent feasible. Specific methods of collection and analysis must be identified. Sample collection, storage, and analysis shall be performed according to the most recent version of USEPA Methods, such as the latest editions, as applicable, of: (1) Methods for the Analysis of Organics in Water and Wastewater (USEPA 600 Series), (2) Test Methods for Evaluating Solid Waste (SW-846, latest edition), and (3) Methods for

STANDARD PROVISIONS & REPORTING REQUIREMENTS

Chemical Analysis of Water and Wastes (USEPA 600/4-79-020), and in accordance with the approved Sample Collection and Analysis Plan. Appropriate sample preparation techniques shall be used to minimize matrix interferences.

9. If methods other than USEPA-approved methods or Standard Methods are used, or there is a proposed alternant USEPA method than the one listed in the MRP, the proposed methodology shall be submitted for review and approval prior to use, including information showing its equivalence to the required method.
10. The **methods of analysis and the detection limits** used must be appropriate for the expected concentrations. For the monitoring of any constituent or parameter that is found in concentrations which produce more than 90% non-numerical determinations (i.e., “trace” or “ND”) in data from background monitoring points for that medium, the analytical method having the lowest MDL shall be selected from among those methods which would provide valid results in light of any matrix effects or interferences.
11. The laboratory reporting limit (RL) for all reported monitoring data shall be set no greater than the practical quantitation limit (PQL).
12. **“Trace” results** - results falling between the MDL and the PQL - shall be reported as such, and shall be accompanied both by the estimated MDL and PQL values for that analytical run.
13. Laboratory data shall not be altered or revised by the Discharger. If the Discharger observes potential lab errors, it shall identify the issue in the monitoring report and shall describe steps that will be taken to prevent similar errors in the future.
14. **MDLs and PQLs** shall be derived by the laboratory for each analytical procedure, according to State of California laboratory accreditation procedures. These MDLs and PQLs shall reflect the detection and quantitation capabilities of the specific analytical procedure and equipment used by the lab, rather than simply being quoted from USEPA analytical method manuals. In relatively interference-free water, laboratory-derived MDLs and PQLs are expected to closely agree with published USEPA MDLs and PQLs. MDLs and PQLs shall be reported.
15. If the laboratory suspects that, due to a change in matrix or other effects, the true detection limit or quantitation limit for a particular analytical run differs significantly from the laboratory-derived MDL/PQL values, the

results shall be flagged in the laboratory report accordingly, along with estimates of the detection limit and quantitation limit actually achieved. The **MDL shall always be calculated such that it represents the lowest achievable concentration associated with a 99% reliability of a nonzero result**. The PQL shall always be calculated such that it represents the lowest constituent concentration at which a numerical value can be assigned with reasonable certainty that it represents the constituent's actual concentration in the sample. Normally, PQLs should be set equal to the concentration of the lowest standard used to calibrate the analytical procedure.

16. All **QA/QC** data shall be reported, along with the sample results to which they apply, including the method, equipment, analytical detection and quantitation limits, the percent recovery, an explanation for any recovery that falls outside the QC limits, the results of equipment and method blanks, the results of spiked and surrogate samples, the frequency of quality control analysis, and the name and signature of a responsible person from the laboratory. **Sample results shall be reported unadjusted for blank results or spike recoveries**. In cases where contaminants are detected in QA/QC samples (i.e., field, trip, or lab blanks), the accompanying sample results shall be appropriately flagged, but the analytical results shall not be adjusted.
17. Unknown chromatographic peaks shall be reported, flagged, and tracked for potential comparison to subsequent unknown peaks that may be observed in future sampling events. Identification of unknown chromatographic peaks that recur in subsequent sampling events may be required.
18. The sampling interval of each monitoring well shall be appropriately screened and fitted with an appropriate filter pack to enable collection of representative groundwater samples [Title 27, § 20415(b)(4)(B)]. Groundwater samples shall not be field-filtered prior to laboratory analysis [40 C.F.R. § 258.53(b)]. Groundwater samples needing filtering (e.g., samples to be analyzed for dissolved metals) shall be filtered by the laboratory prior to analysis.
19. Groundwater elevations shall be measured in each well immediately prior to purging, each time groundwater is sampled. The owner or operator shall determine the rate and direction of groundwater flow each time groundwater is sampled. Groundwater elevations in wells which monitor the same waste management area shall be measured within a period of time short enough to avoid temporal variations in groundwater flow which

could preclude accurate determination of groundwater flow rate and direction [40 C.F.R. § 258.53(d)].

20. Monitoring wells, piezometers, and other measurement, sampling, and analytical devices must be operated and maintained so that they perform to design specifications throughout the life of the monitoring program [40 C.F.R. § 258.51(c)(2)]. Monitoring devices that cannot be operated and maintained to perform to design specifications shall be replaced after review and approval of a report (i.e., work plan) for the proposed replacement devices.
21. All borings are to be logged during drilling under the direct supervision of a registered geologist or registered civil engineer with expertise in stratigraphic well logging [Title 27, § 20415(e)(2)].
22. Soils are to be described according to the Unified Soil Classification System [Title 27, § 20415(e)(2)(A)]. Rock is to be described in a manner appropriate for the purpose of the investigation [Title 27, § 20415(e)(2)(B)].
23. The Discharger shall submit a work plan for review and approval at least **60 days** prior to installation or abandonment of groundwater monitoring wells.
24. The Discharger shall provide Central Valley Water Board staff a minimum of **one-week** notification prior to commencing any field activities related to the installation or abandonment of monitoring devices.
25. The water quality protection standard shall consist of the constituents of concern (COC), concentration limits, and the point of compliance. The water quality protection standard shall apply during the active life of the waste management unit, closure period, post-closure maintenance period, and any compliance period under Title 27, section 20410 [Title 27, § 20390].
26. The point of compliance at which the water quality protection standard applies is a vertical surface located at the hydraulically downgradient limit of the waste management unit that extends through the uppermost aquifer underlying the unit [Title 27, § 20405].
27. The compliance period is the minimum period of time during which the Discharger shall conduct a water quality monitoring program and is the number of years equal to the active life of the waste management unit plus the closure period [Title 27, § 20410(a)].

STANDARD PROVISIONS & REPORTING REQUIREMENTS

28. The groundwater monitoring system shall include a sufficient number of monitoring points, installed at appropriate locations, to yield groundwater samples from the uppermost aquifer that represent the quality of groundwater that has not been affected by a release from the waste management unit [Title 27, § 20415(b)(1)(A)].
29. The Detection Monitoring Program shall include a sufficient number of monitoring points, installed at appropriate locations and depths to yield groundwater samples from the uppermost aquifer that represent the quality of groundwater passing the point of compliance to allow the detection of a release from the waste management unit [Title 27, § 20415(b)(1)(B)1.].
30. Additional monitoring points shall be added as necessary to provide the best assurance of the **earliest possible detection** of a release from the waste management unit [Title 27, § 20415(b)(1)(B)2.].
31. The Detection Monitoring Program shall also include a sufficient number of monitoring points installed at appropriate depths and locations to yield groundwater samples from other aquifers or perched zones not already monitored to provide the earliest possible detection of a release from the waste management unit [Title 27, § 20415(b)(1)(B)3. and 4., and §20420(b)].
32. A surface water monitoring system shall be established to monitor each surface water body that could be affected by a release from the waste management unit [Title 27, § 20415(c)].
33. An unsaturated zone monitoring system shall be established for each waste management unit [Title 27, § 20415(d)].
34. The Discharger shall notify Central Valley Water Board staff within **seven days** if fluid is detected in a previously dry LCRS, unsaturated zone monitoring system, or if a progressive increase is detected in the volume of fluid in a LCRS [Title 27, § 21710(c)(3)].
35. Driller's logs for all monitoring wells shall to be submitted to the Central Valley Water Board and the Department of Water Resources [Wat. Code, § 13751 and Title 27, § 20415(b)(3)].
36. Groundwater elevation, temperature, electrical conductivity, turbidity, and pH are to be accurately measured at each well each time groundwater is sampled [Title 27, § 21415(e)(13)].

STANDARD PROVISIONS & REPORTING REQUIREMENTS

37. The groundwater flow rate and direction in the uppermost aquifer and in any zones of perched water and in any additional portions of the zone of saturation being monitored shall be determined at least quarterly [Title 27, § 20415(e)(15)].
38. The Discharger shall graph all analytical data from each monitoring point and background monitoring point and shall submit the graphs to the Central Valley Water Board annually [Title 27, § 20415(e)(14)].
39. For each waste management unit, the Discharger shall collect all data necessary for selecting appropriate data analysis methods for establishing background values for each constituent of concern and for each monitoring parameter [Title 27, § 20420(c)]. The Discharger shall propose a data analysis method that includes a detailed description of the criteria to be used for determining “measurably significant” (as defined in Title 27, section 20164) evidence of a release from the waste management unit and determining compliance with the water quality protection standard [Title 27, § 20415(e)(6) and (7)].
40. For statistical analysis of data, the Discharger shall use one of the methods described in Title 27, section 20415(e)(8)(A)-(E). A non-statistical data analysis method can be used if the method can achieve the goal of the particular monitoring program at least as well as the most appropriate statistical method [Title 27, § 20415(e)(8)]. The Discharger shall use a statistical or nonstatistical data analysis method that complies with Title 27, section 20415(e)(7, 8, 9, and 10), to compare the concentration of each constituent of concern or monitoring parameter with its respective background concentration to determine whether there has been a measurably significant evidence of a release from the waste management unit. For any given monitoring point at which a given constituent has already exhibited a measurably significant indication of a release at that monitoring point, the Discharger may propose to monitor the constituent, at that well, using a concentration-versus-time plot.
41. The Discharger may propose an alternate statistical method [to the methods listed under Title 27, section 20415(e)(8)(A-D)] in accordance with Title 27, section 20415(e)(8)(E), for review and approval.
42. The statistical method shall account for data below the practical quantitation limit (PQL) with one or more statistical procedures that are protective of human health and the environment. Any PQL validated pursuant to Title 27, section 20415(e)(7) that is used in the statistical method shall be the **lowest concentration (or value) that can be**

STANDARD PROVISIONS & REPORTING REQUIREMENTS

reliably achieved within limits of precision and accuracy specified in the WDRs or an approved Sample Collection and Analysis Plan for routine laboratory operating conditions that are available to the facility. The Discharger's technical report (Sample Collection and Analysis Plan and/or Water Quality Protection Standard Report), pursuant to Title 27, section 20415(e)(7), shall consider the PQLs listed in Appendix IX to Chapter 14 of Division 4.5 of Title 22, CCR, for guidance when specifying limits of precision and accuracy. For any given constituent monitored at a background or downgradient monitoring point, an indication that falls between the MDL and the PQL for that constituent (hereinafter called a "trace" detection) shall be identified and used in appropriate statistical or non-statistical tests. Nevertheless, for a statistical method that is compatible with the proportion of censored data (trace and ND indications) in the data set, the Discharger can use the laboratory's concentration estimates in the trace range (if available) for statistical analysis, in order to increase the statistical power by decreasing the number of "ties".

43. The water quality protection standard for organic compounds which are not naturally occurring and not detected in background groundwater samples shall be taken as the detection limit of the analytical method used (e.g., USEPA methods 8260 and 8270).
44. Alternate statistical procedures may be used for determining the significance of analytical results for common laboratory contaminants (i.e., methylene chloride, acetone, diethylhexyl phthalate, and di-n-octyl phthalate) if part of an approved water quality protection standard. Nevertheless, analytical results involving detection of these analytes in any background or downgradient sample shall be reported and flagged for easy reference by Central Valley Water Board staff.
45. **Confirmation of Measurably Significant Evidence of a Release.** Whenever a constituent is detected at a detection monitoring point at a concentration that exceeds the concentration limit from the water quality protection standard, the Discharger shall conduct verification sampling to confirm if the exceedance is due to a release or if it is a false-positive (unless previous monitoring has already confirmed a release for that constituent at that monitoring point). An exceedance of the concentration limit from the water quality protection standard is considered measurably significant evidence of a release that must be either confirmed or denied. There are two separate verification testing procedures:
 - a. Standard Monitoring Specification I.46 provides the procedure for analytes that are detected in less than 10% of the background

samples such as non- naturally occurring constituents like volatile organic compounds; and

- b. Standard Monitoring Specification I.47 provides the procedure for analytes that are detected in 10% or greater of the background samples such as naturally occurring constituents like chloride.

46. **Verification Procedure for Analytes Detected in Less than 10% of Background Samples.** The Discharger shall use the following non-statistical method for all analytes that are detected in less than 10% of the background samples. The non-statistical method shall be implemented as follows:

- a. **Initial Determination of Measurably Significant Evidence of a Release.** Identify each analyte in the current detection monitoring point sample that exceeds either its respective MDL or PQL, and for which a release has not been previously confirmed. The Discharger shall conclude that the exceedance provides a preliminary indication of a release or a change in the nature or extent of the release, at that monitoring point, if **either**:
 - i. The data contains two or more analytes that equal or exceed their respective MDLs; or
 - ii. The data contains one or more analyte that equals or exceeds its PQL.
- b. **Discrete Retest** [Title 27, § 20415(e)(8)(E) and § 20420(j)(1-3)]:
 - i. In the event that the Discharger or Central Valley Water Board staff concludes (pursuant to paragraph I.46.a., above) that there is a preliminary indication of a release, then the Discharger shall immediately notify Central Valley Water Board staff by phone or e-mail and, within 30 days of such indication, shall collect two new (retest) samples from the monitoring point where the release is preliminarily indicated and analyze them for the constituents that caused the need for the retest.
 - ii. **Confirmation of a Release.** As soon as the retest data are available, the Discharger shall conclude that measurably significant evidence of a release is confirmed if (not including the original sample) two or more analytes equal or exceed

their respective MDLs or if one or more analyte equals or exceeds its PQL. The Discharger shall then:

- (A) **Immediately** verbally notify the Central Valley Water Board whether or not the retest confirmed measurably significant evidence of a release for the analyte at the monitoring point, and follow up with written notification submitted by certified mail within seven days of the verbal notification; and
- (B) Carry out the requirements of Section J, **RESPONSE TO A RELEASE** if a release has been confirmed.
- (C) Add any five-year analyte that is confirmed per this method to the monitoring parameter list such that it is monitored during each regular monitoring event.

47. **Verification Procedure for Analytes Detected in 10% or Greater of the Background Samples.** The Discharger shall use either a statistical or non-statistical method pursuant to Title 27, section 20415(e)(8)(E) for all analytes that are detected in 10% or greater of the background samples. The Discharger shall use one of the statistical methods required in Title 27, section 20415(e)(8)(E) unless another method has been proposed by the Discharger in a Water Quality Protection Standard Report (or equivalent report) and approved by the Central Valley Water Board in a Monitoring and Reporting Program pursuant to Title 27, section 20415(e)(8)(A-D)] or section 20415(e)(8)(E). The method shall be implemented as follows:

- a. **Initial Determination of Measurably Significant Evidence of a Release.** The Discharger shall compare the value reported by the laboratory for each analyte to the statistically-derived concentration limit from the most recent report (Annual Monitoring Report or Water Quality Protection Standard Report) that uses the approved statistical procedure. If the value exceeds the concentration limit for that constituent, the Discharger shall conclude that there is measurably significant evidence of a release [Title 27, § 20420(i)].
- b. **Retest Method** [Title 27, § 20415(e)(8)(E) and § 20420(j)(1-3)].
 - i. In the event that the Discharger or Central Valley Water Board staff concludes (pursuant to paragraph 1.47.a., above) that there is a preliminary indication of a release, then the

STANDARD PROVISIONS & REPORTING REQUIREMENTS

Discharger shall immediately notify Central Valley Water Board staff by phone or e-mail and, within 30 days [Title 27, § 20415(e)(3)] of such indication, the Discharger shall implement a verification procedure/retest option, in accordance with Title 27, sections 20415(e)(8)(E) and 20420(j)(2). The verification procedure shall include either a single “composite” retest (i.e., a statistical analysis that augments and reanalyzes the data from the monitoring point that indicated a release) or shall consist of at least two “discrete” retests (i.e., statistical analyses each of which analyzes only newly-acquired data from the monitoring point that indicated a release) [Title 27, § 20415(e)(8)(E)]. The Discharger may use an alternate method previously approved by the Central Valley Water Board and included in the Monitoring and Reporting Program. The verification procedure shall comply with the requirements of Title 27, section 20415(e)(8)(E) in addition to the performance standards of Title 27, section 20415(e)(9). The retest samples shall be collected from the monitoring point where the release is preliminarily indicated and shall be analyzed for the constituents that caused the need for the retest. For any indicated monitoring parameter or constituent of concern, if the retest results of one or more of the retest data suites confirm the original indication, the Discharger shall conclude that measurably significant evidence of a release has been confirmed.

- ii. **Confirmation of a Release.** As soon as the retest data are available, the Discharger shall evaluate the results pursuant to paragraph I.47.b.1, above and shall:
 - (A) **Immediately** verbally notify the Central Valley Water Board whether or not the retest confirmed measurably significant evidence of a release for the analyte at the monitoring point, and follow up with written notification submitted by certified mail within seven days of the verbal notification; and
 - (B) Carry out the requirements of Section J, **RESPONSE TO A RELEASE** if a release has been confirmed.

- (C) Add any five-year analyte that is confirmed per this method to the monitoring parameter list such that it is monitored during each regular monitoring event.

- 48. **Physical Evidence of a Release.** If the Discharger determines that there is a significant physical evidence of a release, the Discharger shall immediately verbally notify Central Valley Water Board staff and provide written notification by certified mail within 7 days of such determination, and within 90 days shall submit an amended report of waste discharge to establish an Evaluation Monitoring Program [Title 27, § 20385(a)(3) and § 20420(l)(1) & (2)].

J. Response to Release

- 1. **Measurably Significant Evidence of a Release Has Been Confirmed.** If the Discharger has confirmed that there is measurably significant evidence of a release from a waste management unit pursuant to Standard Monitoring Specification I.46 or I.47, then the Discharger shall:
 - a. **Immediately** sample all monitoring points in the affected medium at that waste management unit and determine the concentration of all monitoring parameters and constituents of concern for comparison with established concentration limits. Because this constituent of concern scan does not involve statistical testing, the Discharger will need to collect and analyze only a single water sample from each monitoring point in the affected medium [Title 27, § 20420(k)(1)].
 - b. **Within 14 days** of confirming measurably significant evidence of a release, the Discharger shall (for releases from MSW landfill units) notify all persons who own the land or reside on the land that directly overlies any portion of the plume of contamination if contaminants have migrated off-site if indicated by sampling of detection monitoring wells [40 C.F.R. § 258.55(g)(1)(iii)].
 - c. **Within 90 days** of confirming measurably significant evidence of a release, the Discharger shall submit an amended report of waste discharge to establish an Evaluation Monitoring Program meeting the requirements of Title 27, sections 20420(k)(5)(A-D), including but not limited to the results of sampling pursuant to paragraph J.1.a, above. The Evaluation Monitoring Program shall be designed for the collection and analysis of all data necessary to assess the nature and extent of the release and to determine the spatial distribution and concentration of each constituent throughout the

zone affected by the release [Title 27, § 20420(k)(5) and § 20425(b)]. For releases from MSW landfill units, the Evaluation Monitoring Program shall also include any additional proposals necessary to comply with 40 C.F.R. § 258.55, particularly the additional monitoring well required by 40 C.F.R. § 258.55(g)(1)(ii).

- d. **Within 180 days** of confirming measurably significant evidence of a release, the Discharger shall submit to the Central Valley Water Board an initial engineering feasibility study for a Corrective Action Program necessary to meet the requirements of Title 27, section 20430. At a minimum, the initial engineering feasibility study shall contain a detailed description of the corrective action measures that could be taken to achieve background concentrations for all constituents of concern [Title 27, § 20420(k)(6)].
- e. If the Discharger confirms that there is measurably significant evidence of a release from the waste management unit at any monitoring point, the Discharger may attempt to demonstrate that a source other than the waste management unit caused the evidence of a release or that the evidence is an artifact caused by an error in sampling, analysis, or statistical evaluation or by natural variation in groundwater, surface water, or the unsaturated zone. The Discharger may make a demonstration pursuant to Title 27, section 20420(k)(7) in addition to or in lieu of submitting both an amended report of waste discharge or an engineering feasibility study; however, the Discharger is not relieved of the requirements and due dates of Title 27, sections 20420(k)(6) & (7) unless Central Valley Water Board staff agree that the demonstration successfully shows that a source other than the waste management unit caused the evidence of a release or that the evidence resulted from error in sampling, analysis, or statistical evaluation or from natural variation in groundwater, surface water, or the unsaturated zone. In order to make this demonstration, the Discharger shall notify the Central Valley Water Board by certified mail of the intent to make the demonstration **within seven days** of determining measurably significant evidence of a release, and shall submit a report **within 90 days** of determining measurably significant evidence of a release [Title 27, § 20420(k)(7)].
- f. **Within 90 days** of the date that the Evaluation Monitoring Program from paragraph J.1.c is approved (the date is it established), the Discharger shall complete and submit the following:

- i. **Results and Assessment for the Evaluation Monitoring Program.** A report with the results and assessment based on the approved Evaluation Monitoring Program [Title 27, § 20425(b)].
 - ii. **Updated Engineering Feasibility Study.** An updated engineering feasibility study for corrective action based on the data collected to delineate the release and data from the ongoing monitoring program required under Title 27, section 20425(e) [Title 27, § 20425(c)].
 - iii. **Amended ROWD for a Corrective Action Program.** An amended report of waste discharge to establish a Corrective Action Program meeting the requirements of Title 27, section 20430 based on the data collected to delineate the release and based on the updated engineering feasibility study [Title 27, § 20425(d)].
- g. The Discharger shall (for releases from MSW landfill units) discuss the results of the updated engineering feasibility study, prior to the final selection of a remedy, in a public meeting with interested and affected parties [40 C.F.R. § 258.56(d)].

K. General Provisions

1. In the event the Discharger does not comply or will be unable to comply with any prohibition or limitation of this Order for any reason, the Discharger shall notify the appropriate Central Valley Water Board office by telephone as soon as it or its agents have knowledge of such noncompliance or potential for noncompliance, and shall confirm this notification in writing **within two weeks**. The written notification shall state the nature, time, and cause of noncompliance, and shall describe the measures being taken to prevent recurrences and shall include a timetable for corrective actions.
2. All reports and transmittal letters shall be signed by persons identified below:
 - a. For a corporation: by a principal executive officer of at least the level of senior vice-president.
 - b. For a partnership or sole proprietorship: by a general partner or the proprietor.

- c. For a municipality, state, federal or other public agency: by either a principal executive officer or ranking elected or appointed official.
- d. A duly authorized representative of a person designated in a, b or c above if:
 - i. The authorization is made in writing by a person described in a, b, or c of this provision;
 - ii. The authorization specifies either an individual or a position having responsibility for the overall operation of the regulated facility or activity, such as the position of plant manager, operator of a Unit, superintendent, or position of equivalent responsibility (a duly authorized representative may thus be either a named individual or any individual occupying a named position); and
 - iii. The written authorization is submitted to the Central Valley Water Board.
- e. Any person signing a document under this Section shall make the following certification:

I certify under penalty of law that I have personally examined and am familiar with the information submitted in this document and all attachments and that, based on my inquiry of those individuals immediately responsible for obtaining the information, I believe that the information is true, accurate, and complete. I am aware that there are significant penalties for submitting false information, including the possibility of fine and imprisonment.

- 3. The Discharger shall take all reasonable steps to minimize any adverse impact to the waters of the State resulting from noncompliance with this Order. Such steps shall include accelerated or additional monitoring as necessary to determine the nature, extent, and impact of the noncompliance.
- 4. The owner of the waste management facility shall have the continuing responsibility to assure protection of waters of the state from discharged wastes and from gases and leachate generated by discharged waste

STANDARD PROVISIONS & REPORTING REQUIREMENTS

during the active life, closure, and post-closure maintenance period of the waste management units and during subsequent use of the property for other purposes.

5. The fact that it would have been necessary to halt or reduce the permitted activity in order to maintain compliance with this Order shall not be regarded as a defense for the Discharger's violations of this Order.
6. The Discharger shall notify the Central Valley Water Board of a material change in; the types, quantity, or concentrations of wastes discharged; site operations and features; or proposed closure procedures, including changes in cost estimates. This notification shall be given a reasonable time before the changes are made or become effective. No changes shall be made without Central Valley Water Board approval following authorization for closure pursuant to the site Notification of Closure [Title 27, § 21710(a)(4)].
7. The Discharger shall maintain legible records of the volume and type of each waste discharged at each waste management unit or portion of a unit, and the manner and location of discharge. Such records shall be maintained by the Discharger until the beginning of the post-closure maintenance period. These records shall be on forms approved by the State Water Board or Central Valley Water Board and shall be maintained at the waste management facility until the beginning of the post-closure maintenance period. These records shall be available for review by representatives of the State Water Board or Central Valley Water Board at any time during normal business hours. At the beginning of the post-closure maintenance period, copies of these records shall be sent to the Central Valley Water Board [Title 27, § 21720(f)].
8. In the event of any change in landowner or the operator of the waste management facility, the Discharger shall notify the succeeding owner or operator in writing of the existence of this Order. A copy of that notification shall be sent to the Central Valley Water Board.
9. In the event of any change of ownership or responsibility for construction, operation, closure, or post-closure maintenance of the waste discharge facilities described in this Order, the Discharger shall notify the Central Valley Water Board prior to the effective date of the change and shall include a statement by the new Discharger that construction, operation, closure, or post-closure maintenance will be in compliance with this Order and any revisions thereof [Title 27, § 21710(c)(1)].

STANDARD PROVISIONS & REPORTING REQUIREMENTS

10. To assume ownership or operation under this Order, the succeeding owner or operator must apply in writing to the Central Valley Water Board requesting transfer of the Order within **14 days** of assuming ownership or operation of this facility. The request must contain the requesting entity's full legal name, the State of incorporation if a corporation, the name and address and telephone number of the persons responsible for contact with the Central Valley Water Board, and a statement. The statement shall comply with the signatory requirements contained in General Provision K.2 and state that the new owner or operator assumes full responsibility for compliance with this Order. Failure to submit the request shall be considered a discharge without requirements, a violation of the Water Code. Transfer of this Order shall be approved or disapproved by the Central Valley Water Board.

L. Storm Water Provisions

1. New and existing Class III landfills shall be designed, constructed, operated, and maintained to prevent inundation or washout due to floods with a 100-year return period [Title 27, § 20260(c)].
2. New and existing Class II landfills shall be designed, constructed, operated, and maintained to prevent inundation or washout due to floods with a 100-year return period [Title 27, § 20250(c)].
3. The Discharger shall design storm water conveyance systems for Class III units for a 100-year, 24-hour storm event, and shall design storm water conveyance systems for Class II units for a 1,000-year, 24-hour storm event [Title 27, § 21750(e)(3)].
4. MSW landfills located in a 100-year floodplain shall demonstrate that the landfill unit will not restrict the flow of the 100-year flood, reduce the temporary water storage capacity of the floodplain, or result in washout of solid waste so as to pose a hazard to human health or the environment [40 C.F.R. § 258.11(a)].
5. Waste management units and their respective containment structures shall be designed and constructed to limit, to the greatest extent possible, ponding, infiltration, inundation, erosion, slope failure, washout, and overtopping under the precipitation conditions for the unit [Title 27, § 20365(a)].
6. Precipitation on landfills or waste piles which is not diverted by covers or drainage control systems shall be collected and managed through the

LCRS, which shall be designed and constructed to accommodate the precipitation conditions for each class unit [Title 27, § 20365(b)].

7. Diversion and drainage facilities shall be designed, constructed, and maintained to [Title 27, § 20365(c)]:
 - a. accommodate the anticipated volume of precipitation and peak flows from surface runoff and under the precipitation conditions for the waste management unit;
 - b. effectively divert sheet flow runoff laterally, via the shortest distance, into the drainage and collection facilities;
 - c. prevent surface erosion;
 - d. control and intercept run-on, in order to isolate uncontaminated surface waters from water that might have come into contact with waste;
 - e. take into account:
 - i. for closed waste management units and for closed portions of units, the expected final contours of the closed unit, including its planned drainage pattern;
 - ii. for operating portions of waste management units other than surface impoundments, the unit's drainage pattern at any given time;
 - iii. the possible effects of the waste management unit's drainage pattern on and by the regional watershed;
 - iv. the design capacity of drainage systems of downstream and adjacent properties by providing for the gradual release of retained water downstream in a manner which does not exceed the expected peak flow rate at the point of discharge if there were no waste management facility; and
 - f. preserve the system's function. The Discharger shall periodically remove accumulated sediment from the sedimentation or detention basins as needed to preserve the design capacity of the system.

STANDARD PROVISIONS & REPORTING REQUIREMENTS

8. Collection and holding facilities associated with precipitation and drainage control systems shall be emptied immediately following each storm or otherwise managed to maintain the design capacity of the system [Title 27, § 20365(d)].
9. Surface and subsurface drainage from outside of a waste management unit shall be diverted from the unit [Title 27, § 20365(e)].
10. Cover materials shall be graded to divert precipitation from the waste management unit, to prevent ponding of surface water over wastes, and to resist erosion as a result of precipitation [Title 27, § 20365(f)].

Any drainage layer in the final cover shall be designed and constructed to intersect with the final drainage system for the waste management unit in a manner promoting free drainage from all portions of the drainage layer [Title 27, §20365(f)].

CALIFORNIA REGIONAL WATER QUALITY CONTROL BOARD
CENTRAL VALLEY REGION

[TENTATIVE] WASTE DISCHARGE REQUIREMENTS ORDER R5-20XX-XXXX
FOR
WASTE MANAGEMENT OF ALAMEDA COUNTY, INC
ALTAMONT SOLIDIFICATION FACILITY
Alameda County

INFORMATION SHEET

The Discharger seeks to construct and operate the Altamont Solidification Facility (Facility) located at the Altamont Landfill Resource Recovery Facility (ALRRF) at 10840 Altamont Pass Road, which is approximately 3.5 miles east of the City of Livermore's eastern boundary in Alameda County. The proposed Facility is related to the ALRRF, a municipal solid waste landfill, which is also owned and operated by the Discharger. The proposed Facility is situated on less than 0.5-acres on the ALRRF property and regulated under separate Orders, including Cease and Desist Order (CDO) R5-2021-0020. CDO R5-2021-0020, Directive 17 requires the Discharger to "...submit a Report of Waste Discharge to install [ALRRF] off waste liquid solidification basins completed as Class II liquid waste management units" in order to facilitate decommissioning of existing substandard solidification basins on ALRRF, Fill Area 1. Between 19 October 2021 and 9 July 2023, the Discharger submitted multiple elements of a Report of Waste Discharge (ROWD) for the proposed Altamont Solidification Facility in response to the CDO Directive. The ROWD includes, in part, a Design Report, Operations and Maintenance Plan, proposed monitoring plan, cost estimate for clean closure, and a completed signed application form for waste discharge requirements.

Proposed Waste Management Units

The proposed solidification basins' purpose and function is to solidify liquid wastes with various solid wastes (described as "extenders") in two lined basins constructed as Class II surface impoundments with reinforced concrete primary liners and an adjacent stockpile area constructed as a waste pile, within the meaning of California Code of Regulations, title 27 ("Title 27"), section 20005 et seq. Examples of "extenders" proposed for storage and management at the Solidification Facility include, but are not limited to, soil, green waste, treated auto shredder waste (TASW), ash, cement kiln dust, processed construction and demolition debris material/screenings, ground wood waste or a combination of these materials.

These WDRs also establish construction standards and final construction detail approval process for three new proposed waste management units: (1) "Yellow Flag" basin designed to hold 350 tons of wastes; (2) "Blue Flag" basin designed to hold 70 tons of wastes; and (3) Extender Stockpile and Work Area used for operational storage of TASW and access for equipment, customer trucks, and trucks hauling TASW. These WDRs provide for a process for the Discharger to establish background groundwater conditions, develop a detection monitoring program designed to distinguish possible

release from the ALRRF from a possible release from the proposed Solidification Facility, and establish water quality protection standards for the proposed new waste management units. These WDRs require the Discharger provide all WQPS elements prior to placement of wastes in the waste management units.

California Environmental Quality Act

On 9 March 2000 the Alameda County Board of Supervisors certified a January 2000 Revised Final Environmental Impact Report prepared to correct specific deficiencies identified in a court case challenging the original March 1996 Final Environmental Impact Report (EIR) prepared for the ALRRF. The Revised Final EIR also consists of the 29 September 1995 Draft EIR and the 1996 Response To Comments Addendum. Waste Management of Alameda County operates the ALRRF facility under Conditional Use Permit C-5512 first issued by the Zoning Administrator in May 1996 and re-issued on 9 March 2000. The proposed Facility upgrades, consolidates, and replaces the existing and operating solidification basin facility by relocating the facility to an area within the 850-acre footprint considered by the 1995 Draft EIR and incorporated into the 2000 Revised Final Environmental Impact Report.

The Revised Final EIR identified the Central Valley Board as a State agency which exercises discretionary approval over the construction and operation of a landfill, either directly through the issuance of permits or indirectly through the development of design and operational guidelines. The Revised Final EIR found that compliance with regulations established for waste and site classifications and waste management requirements for treatment, storage, and disposal in landfills, surface impoundments, waste piles, and land treatment facilities enforced by the Central Valley Water Board through the issuance of Waste Discharge Requirements which contain siting and design criteria, water quality monitoring and corrective action requirements for landfills will provide adequate water quality protection and reduce potential impacts to a less than significant level.

The Solidification Facility is intended to replace and upgrade the ALRRF's existing solidification facilities to ensure that associated operations are carried out in accordance with applicable law and policy, including but not limited to, Title 27 and State Water Resources Control Board Resolution 93-62. The proposed Solidification Facility will have substantially the same purpose and capacity as the facility being replaced and the associated waste discharges authorized by these WDRs are expected to meet water quality parameters that are the same as, or better than, currently applicable parameters. Because the proposed Solidification Facility will replace and upgrade an existing feature of an already existing and operating landfill, it can be seen with certainty that there is no

possibility that the activities authorized by these WDRs will have a significant effect on the environment.

The adoption of these WDRs is exempt from the requirements of the California Environmental Quality Act (CEQA) pursuant to California Code of Regulations, title 14, sections 15301 (Minor Alteration to Existing Facility), 15302 (Replacement or Reconstruction of Existing Facility), and 15061, subdivision (b)(3) (Common Sense Exemption).

Facility Design Review & Authorization

These WDRs implement statutes and regulations, including Title 27 requirements. These WDRs include a prohibition of “material” changes to the approved liner design; restrict changes in the character, location, or volume of waste discharge; and set forth Facility-specific requirements for initiating a new discharge, including requirements relating to establishing monitoring networks prior to discharging waste materials.

Central Valley Water Board staff are conducting engineering and geology technical review of the details of the Discharger’s proposed drawings, construction specifications, and CQA documents (collectively “Proposed Construction Details”) and related submissions. The technical complexity, purpose, and proximity of the Facility to the adjacent landfill represent unique technical, regulatory, construction, and operational challenges for the parties. These and other challenges increase the importance of the engineering and geology technical review and feedback process between Central Valley Water Board staff and the Discharger.

The goals of the ongoing engineering and geology technical review of the details of the Discharger’s Proposed Construction Details include, but are not limited to, 1.) WDRs which implement requirements under authority given in Water Code section 13000 et seq. and California Code of Regulations, title 27 (Title 27), section 20005 et seq which reflect key design details for the Facility and; 2.) WDRs which establish a framework for construction and use of the Facility; 3.) WDRs which establish a framework for the Discharger to complete site characterization and groundwater monitoring tasks required prior to Facility use; and 4.) Provide feedback to the Discharger to support preparation of Final Construction Details which comply with these WDRs.

These WDRs incorporate Central Valley Water Board staff recommended revisions to previously circulated tentative WDRs following review of multiple iterations of the Discharger’s Proposed Construction Details and review of public comments received regarding tentative WDRs. Examples of revisions include, but are not limited to, requirements for hydraulic performance testing of installed reinforced concrete primary liner systems, design clarifications relating to the basin designs and configuration of the waste pile area, clarification of the proposed configuration of leachate collection removal

and storage systems, and a process for characterizing liquid wastes prior to discharge to the basins. Without these and other revisions, previous versions of tentative WDRs would not reflect key design details (including revisions thereto) and would likely result in Central Valley Water Board reconsideration of WDRs for the Facility.

These WDRs require written Central Valley Board authorization of Final Construction Details prior to the Discharger commencing construction related activities (other than preparatory earthmoving and grading). The Executive Officer may provide written authorization of Final Construction Details pursuant to delegated authority authorized by the Central Valley Water Board pursuant to Water Code section 13223.