

**City of Compton**  
Public Works/Municipal Utilities  
205 South Willowbrook Avenue  
Compton, CA 90220



Office: (310) 605-5505  
Fax: (310) 605-6326

January 22, 2018

Mr. Samuel Unger, P.E.  
Executive Officer  
Los Angeles Regional Water Quality Control Board  
320 West 4<sup>th</sup> Street, Suite 200  
Los Angeles, CA 90013

Attention: Ivar Ridgeway

**RE: ALTERNATIVE DESIGN CRITERIA FOR FILTERA SYTEMS BIOFILTRATION AND BEST MANAGEMENT PRACTICE SUBMITTED FOR YOUR REVIEW AND APPROVAL.**

Dear Mr. Unger:

The Los Angeles County MS4 Permit (Order No. R4-2012-0175), as amended by Order No. WQ 2015-0075, qualifies and defines conventional "biofiltration" based on specific design and sizing criteria in Attachment H of the permit. As a provision of Attachment H, when a proposed biofiltration BMP(s) does not meet the conventional design criteria then the permittee can submit alternate design criteria to the Regional Board's Executive Officer for approval.

In the City of Compton a developer is proposing to use a proprietary biofiltration BMP which does not meet the conventional design criteria, as detailed, in Attachment H of the MS4 Permit. However, the company of this proprietary biofiltration BMP does provide alternative design criteria that the City of Compton Public Works Department would like to formally submit for your consideration.

Please allow this cover letter and submittal package to serve as a formal request for your review and approval of the proprietary biofiltration BMP that has been proposed for use at 2200 Artesia Blvd, in the City of Compton. This request is being made on behalf of the developer by the City of Compton.

We look forward to your timely review and approval of this biofiltration BMP.

If you have any questions please contact Bobby Fouladi of my staff or myself at 310-605-5505. We may also be reached by email at [bfouladi@comptoncity.org](mailto:bfouladi@comptoncity.org) and [wjohnson@comptoncity.org](mailto:wjohnson@comptoncity.org).

Sincerely,

A handwritten signature in black ink, appearing to read "Wendell Johnson".

Wendell Johnson, P.E.  
Director of Public Works  
City of Compton

Attachments: Filterra Equivalency Analysis and Design Criteria Report, dated August 2015  
Supporting plans & calculations for 2200 Artesia Blvd

# **FILTERRA EQUIVALENCY ANALYSIS AND DESIGN CRITERIA**

*Pursuant to:*  
**Los Angeles County MS4 Permit  
(Order R4-2012-0175)**

*Prepared for*  
**CONTECH Engineered Solutions**

*Prepared by*  
**Geosyntec**   
consultants  
engineers | scientists | innovators

621 SW Morrison Street, Suite 600  
Portland, Oregon 97205

August 2015

## TABLE OF CONTENTS

Table of Contents.....	i
1 Introduction.....	1
2 BMP descriptions.....	2
2.1 Conventional Biofiltration.....	2
2.2 Filtterra Systems.....	2
3 Basis and Methodology for Evaluating Equivalency.....	4
3.1 Basis for Equivalency.....	4
3.2 Methods and Assumptions for Establishing Baseline Biofiltration Performance.....	4
3.2.1 Hydrologic Performance (Capture Efficiency and Volume Reduction) .....	4
3.2.2 Pollutant Treatment.....	5
3.3 Filtterra Analysis to Determine Equivalent Design Criteria.....	6
3.3.1 Capture Efficiency.....	6
3.3.2 Volume Reduction (Filtterra and Supplemental Infiltration Storage)7	
3.3.3 Pollutant Treatment.....	8
3.3.4 Additional Capture In Lieu of Volume Reduction.....	9
4 Design Methodology and Equivalency Criteria.....	12
5 Discussion and Conclusions.....	16
5.1 Key Observations and Findings.....	16
5.2 Reliability and Limitations.....	17
6 References.....	19
Appendix A – Conventional Biofiltration Design Assumptions for Performance Modeling 21	
Appendix B – SWMM Modeling Methodology and Assumptions.....	23
Equivalency Scenarios.....	23
Overview of SWMM Analysis Framework.....	23
Meteorological Inputs.....	25
Precipitation.....	25
ET Parameters.....	26
Runoff Parameters.....	27
BMP Representation.....	28
Conventional Biofiltration.....	29
Filtterra 30	
Appendix C – Datasets and Analysis Methods for Pollutant Treatment Evaluation.....	32
Data Development and Analysis Framework.....	32

Compilation and Screening of Conventional Biofiltration Studies .....	32
Screening Process for Developing Conventional Biofiltration Sample Pool	32
Screening Results.....	35
Inventory of Bioretention Studies and Screening Results/Rationales .....	35
Compilation of Filtterra Studies.....	36
Data Analysis Method.....	37
Land Use Stormwater Quality Inputs and Assumptions.....	38
Appendix D – Results of Pollutant Treatment Data Analysis .....	42

## 1 INTRODUCTION

The Los Angeles County MS4 Permit (Order No. R4-2012-0175) (MS4 Permit) defines “biofiltration” based on specific design and sizing criteria<sup>1</sup>. In addition, the MS4 Permit allows the Los Angeles County Regional Water Quality Control Board (Regional Board) Executive Officer to approve alternate biofiltration design criteria. The purpose of this analysis was to develop a design basis for Filtterra systems such that these systems will provide reasonably equivalent performance to biofiltration BMPs as defined in the MS4 Permit. This report is provided to the Executive Officer of the Regional Board to support approval of alternative design criteria for Filtterra systems. This report describes the basis for evaluating equivalency, details the design approach and equivalency criteria for Filtterra systems to achieve equivalent performance to conventional biofiltration, and provides the supporting rationales for these equivalency criteria.

The remainder of this report is organized as follows:

Section 2 – BMP Descriptions

Section 3 – Basis and Methodology for Evaluating Equivalency

Section 4 – Filtterra Design Approach and Equivalency Criteria

Section 5 – Discussion and Conclusions

Section 6 – References

Appendix A – Design Assumptions for Conventional Biofiltration

Appendix B – SWMM Modeling Methodology and Assumptions

Appendix C – Datasets and Analysis Methods for Pollutant Treatment Evaluation

Appendix D – Results of BMP Treatment Performance Evaluation

---

<sup>1</sup> BMPs sized and designed per these criteria are referred to in this memorandum as “traditional biofiltration.”

## 2 BMP DESCRIPTIONS

### 2.1 Conventional Biofiltration

Biofiltration (also known as bioretention with underdrain) consists of shallow landscaped depressions that capture and filter stormwater runoff through a planted engineered media. These facilities function as soil and plant-based filtration systems that remove pollutants through a variety of physical, biological, and chemical treatment processes. Biofiltration facilities normally consist of a ponding area, mulch layer, planting soils, and plantings (see typical schematic in Figure 1). An optional gravel layer added below the planting soil coupled with an upturned elbow (or similar hydraulic control approach) can provide additional storage volume for infiltration. As stormwater passes down through the planting soil, pollutants are filtered, adsorbed, and biodegraded by the soil and plants. As defined in Attachment H of the 2012 Los Angeles County MS4 Permit, biofiltration designs must meet a number of specific criteria to be considered “biofiltration” as part of compliance with the MS4 Permit. Conventional biofiltration is typically designed as a “volume-based” BMP, meaning that it is sized based on capture of the runoff from a specific size of storm event.

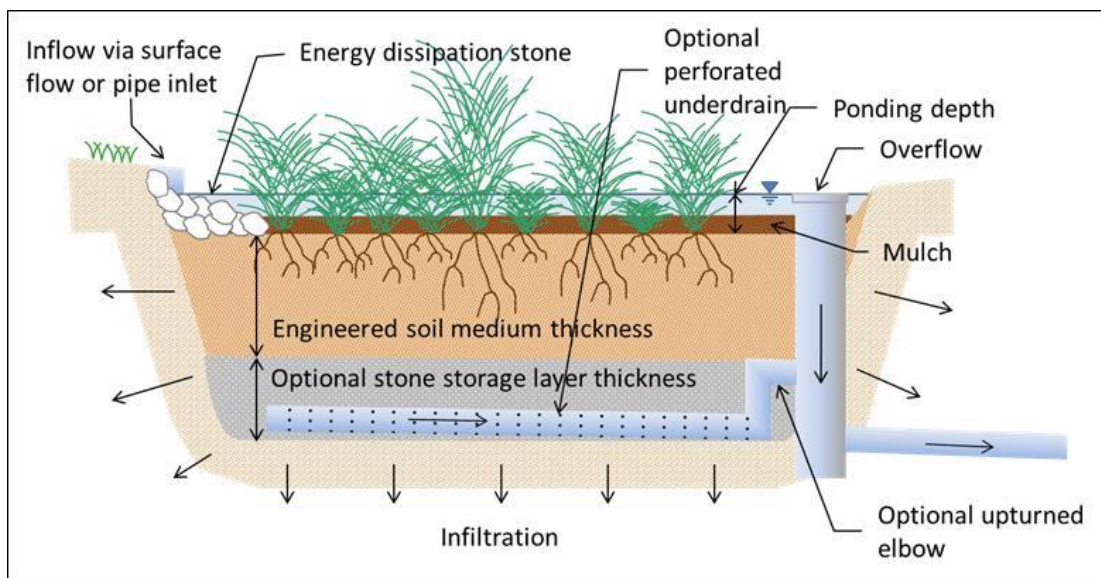

**Figure 1. Cross sections of typical biofiltration system**

### 2.2 Filtterra Systems

Filtterra systems include engineered filter media topped with mulch housed in a precast concrete curb inlet structure with a tree frame and grate cast in the top slab. In addition to the water quality filtering/sorption of stormwater, the engineered media and mulch supports the growth of a tree or other type of plant (see typical configuration in Figure 2). There are three key components of the Filtterra system that contribute to pollutant removal: mulch, engineered filter media, and vegetation and other system biota. Filtterra systems can be configured so that underdrains discharge into downstream retention storage systems. In contrast to conventional

biofiltration, the media filtration rates of Filterra systems are substantially higher, and therefore the footprint of these systems tends to be substantially smaller than conventional biofiltration systems. As a result of smaller footprints, the amount of volume reduction (via infiltration and evapotranspiration) that is typically observed in these systems when not coupled with infiltration systems tends to be relatively low. Because these systems provide relatively limited ponded water volume above the surface of the media, they are typically sized as “flow-based” BMPs based on a design intensity of rainfall rather than “volume-based” BMP based on a design storm depth.

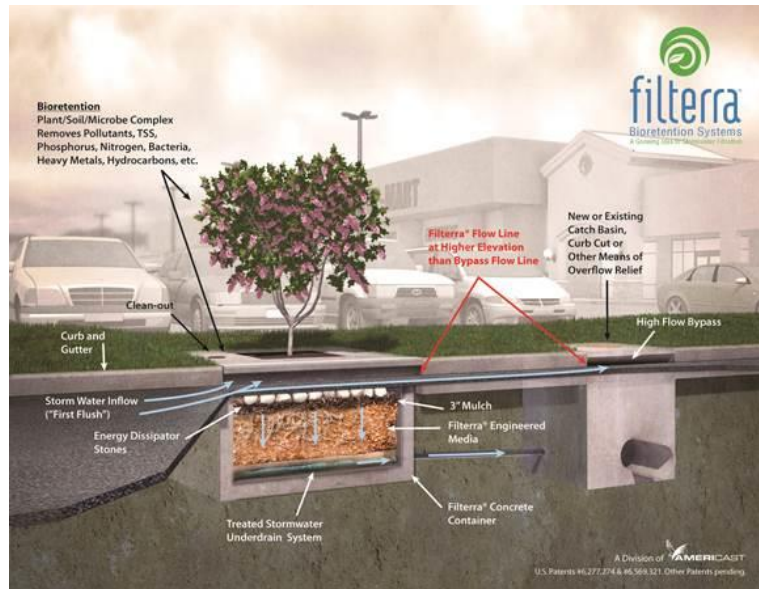

Figure 2. Diagram of the Filterra system (Contech, 2015 via web).

### 3 BASIS AND METHDOLOGY FOR EVALUATING EQUIVALENCY

#### 3.1 Basis for Equivalency

Equivalency was evaluated between conventional biofiltration BMPs meeting the criteria of the MS4 Permit (specifically Attachment H) and Filtterra systems as an alternate biofiltration BMP. Equivalency was determined based on the factors that influence the pollutant load reduction performance of stormwater BMPs:

- **Capture efficiency:** The percent of long term stormwater runoff volume that is “captured” and managed by the BMP (i.e., treated or reduced; not overflowed or bypassed).
- **Volume reduction:** The percent of long term stormwater runoff volume that is “lost” or “reduced” in the BMP to infiltration and evapotranspiration.
- **Concentration reduction:** For the volume that is treated and not reduced, the average difference in concentration between the influent volume and the treated effluent volume.

The equivalency analysis consisted of three parts:

- 1) The baseline performance of conventional biofiltration (capture efficiency, volume reduction, and concentration reduction) was estimated.
- 2) Applying the same methods as used to evaluate the performance of conventional biofiltration, sizing criteria were developed for Filtterra (accompanied by supplemental infiltration systems, where needed) such that Filtterra systems will provide equivalent performance to conventional biofiltration.
- 3) A design methodology for Filtterra systems was developed to ensure consistent application of the equivalent sizing criteria in the design of Filtterra systems.

The following subsections provide information about this analysis.

#### 3.2 Methods and Assumptions for Establishing Baseline Biofiltration Performance

The following subsections summarize the methods and assumptions that were used to evaluate the baseline performance of conventional biofiltration BMPs consistent with Attachment H of the MS4 Permit.

##### 3.2.1 *Hydrologic Performance (Capture Efficiency and Volume Reduction)*

Attachment H of the MS4 Permit specifies a number of criteria that influence the hydrologic performance of the conventional biofiltration BMPs:

- 6 to 18-inch ponding area above media
- Optional layer of mulch
- 2 to 3 feet of engineered filter media (2 feet typical) with a design infiltration rate of 5 to 12 inches/hour; the Attachment H specification calls for a mix of 60 to 80% fine sand and 20 to 40% compost



- Gravel storage layer below the bioretention media to promote infiltration
- Underdrain placed near the top of the gravel layer (or an infiltration sump otherwise provided via an equivalent hydraulic control approach) in cases where underlying soil allows incidental infiltration
- Underdrain discharge to the storm drain
- Capacity (including stored and filtered water) adequate to biofilter 150 percent of the portion of the SWQDv not reliably retained.

Within the bounds established by these criteria, a relatively wide range of actual biofiltration designs could result as a function of site infiltration conditions as well as designer and local jurisdiction preferences. An example of potential design variability is illustrated in Appendix A. For the purpose of this analysis, representative design assumptions were developed within the range of potential design assumptions. These assumptions are also presented in Appendix A with supporting rationales. Long term continuous simulation SWMM modeling was conducted using 15 years of 5-minute resolution precipitation data, as described in Appendix B, to estimate the long term capture efficiency and volume reduction of the baseline biofiltration design scenario for a range of site infiltration rates. Biofiltration BMPs will tend to provide more volume reduction when installed in sites with higher incidental infiltration rates. Table 1 describes the baseline hydrologic performance of biofiltration BMPs.

**Table 1. Baseline Biofiltration Hydrologic Performance**

Site Soil Infiltration Rate, in/hr	Long Term Capture Efficiency (percent of total runoff volume)	Long Term Volume Reduction (percent of total runoff volume) (ET + Infiltration)
0	92 to 94% <sup>1</sup> (93% capture is representative)	4%
0.01		6%
0.05		11%
0.15		22%
0.30 <sup>2</sup>		35%

1 - Capture efficiency varies slightly as a function of soil infiltration rate (and associated differences in design profile) and land use imperviousness. These differences are relatively minor and are considered to be less important than the variability in performance that may result from different design approaches and maintenance conditions that may be encountered. Therefore a single baseline value of 93 percent long term capture was used in this analysis.

2 - A maximum soil infiltration rate of 0.3 inches per hour was evaluated because for soil infiltration rates greater than 0.3 inches per hour the MS4 Permit requires that infiltration be evaluated.

### 3.2.2 Pollutant Treatment

Pollutant treatment performance was evaluated based on analysis of bioretention with underdrain studies in the International Stormwater BMP Databases. Analyses were conducted based on all studies (28 studies) and a screened subset of studies that were considered to be most representative of Attachment H design criteria (16 studies). Additionally, two recent studies from the University of Maryland were added which followed rigorous protocols and evaluated systems sharing many similarities to Attachment H design criteria. Biofiltration research in California is very limited. Two recent monitoring studies were conducted in the San Francisco Bay area (led

by the San Francisco Estuary Institute) on systems with media composition, sizing and design that would conform to Attachment H of the Los Angeles MS4 Permit. While these studies did not collect flow weighted composite influent and effluent samples, they were included in the data set.

Treatment performance was characterized using a moving window bootstrapping method that accounts for the influence of influent concentration on effluent concentration and characterizes the relative uncertainty in performance estimates within each range of influent quality. Both the median and mean summary statistics were evaluated using these methods. Additionally, literature on the influence of biofiltration design variables on performance was summarized to support the criteria that were used to select the 20 BMP studies that were included in the screened dataset. The pollutant treatment evaluation was based on total suspended solids, total phosphorus, total nitrogen, total copper, and total zinc. Influent concentrations characteristic of single family, multi family, commercial, and light industrial land uses were applied to estimate effluent concentrations and concentration change.

Generally, biofiltration provided good removal of TSS, moderate removal of copper and zinc, and generally showed export of nutrients. Export of nutrients tended to be greater when influent concentrations were low. Also, the dataset that was screened to include studies more similar to Attachment H design criteria (i.e., 5 to 12 inches per hour, with compost) showed substantially greater frequency of observed export of nutrients.

Details about pollutant treatment analyses are provided in Appendix C, and results of these analyses are provided in Appendix D.

### **3.3 Filtterra Analysis to Determine Equivalent Design Criteria**

The following paragraphs describe the analyses that were conducted for Filtterra systems to determine the sizing criteria under which Filtterra systems provide equivalent performance to conventional biofiltration.

#### ***3.3.1 Capture Efficiency***

Filtterra capture efficiency is a function of the design precipitation intensity used in sizing the Filtterra system and the time of concentration ( $T_c$ ) of the tributary area. Continuous simulation modeling using the SWMM model, with 15 years of 5-minute resolution precipitation, as described in Appendix B, was used to determine the relationship between design precipitation intensity,  $T_c$ , and long term capture efficiency (Figure 3). Based on this chart, the design guidance presented in Section 4 requires that approved methods, appropriate for the site, are used for calculating  $T_c$  and selecting a runoff coefficient equation to convert the design intensity to a design flowrate.

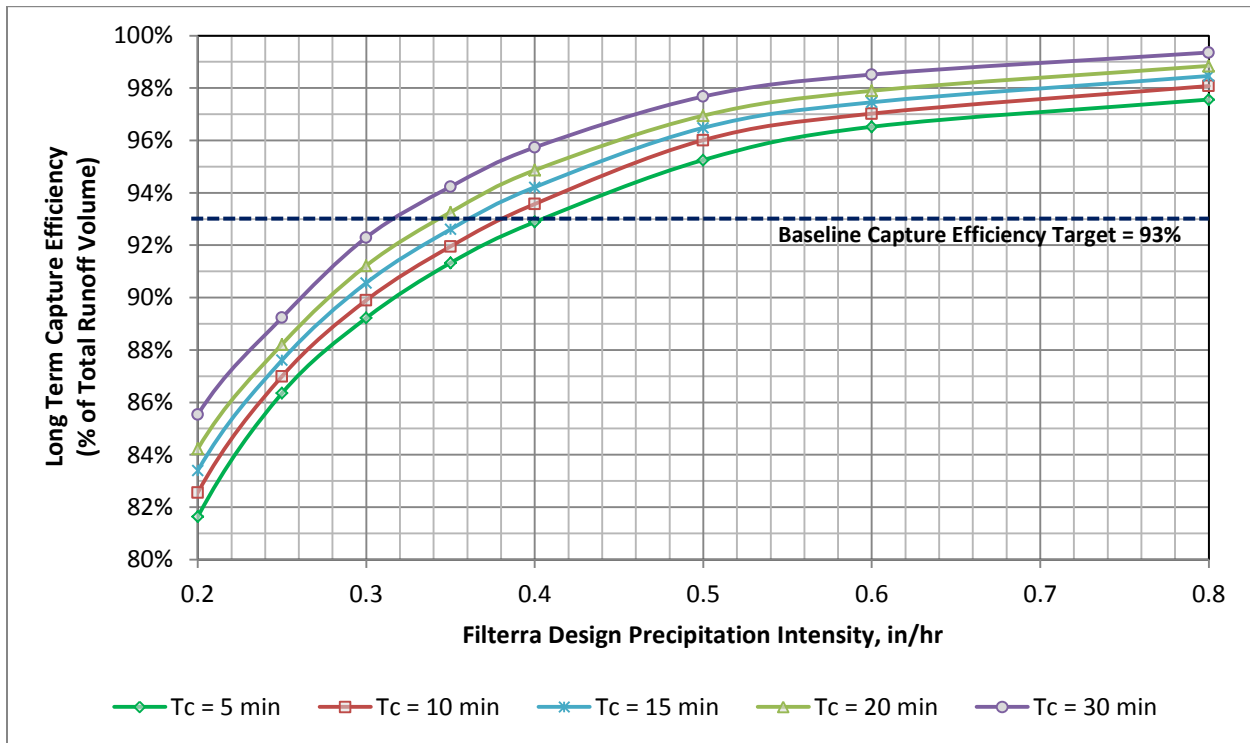
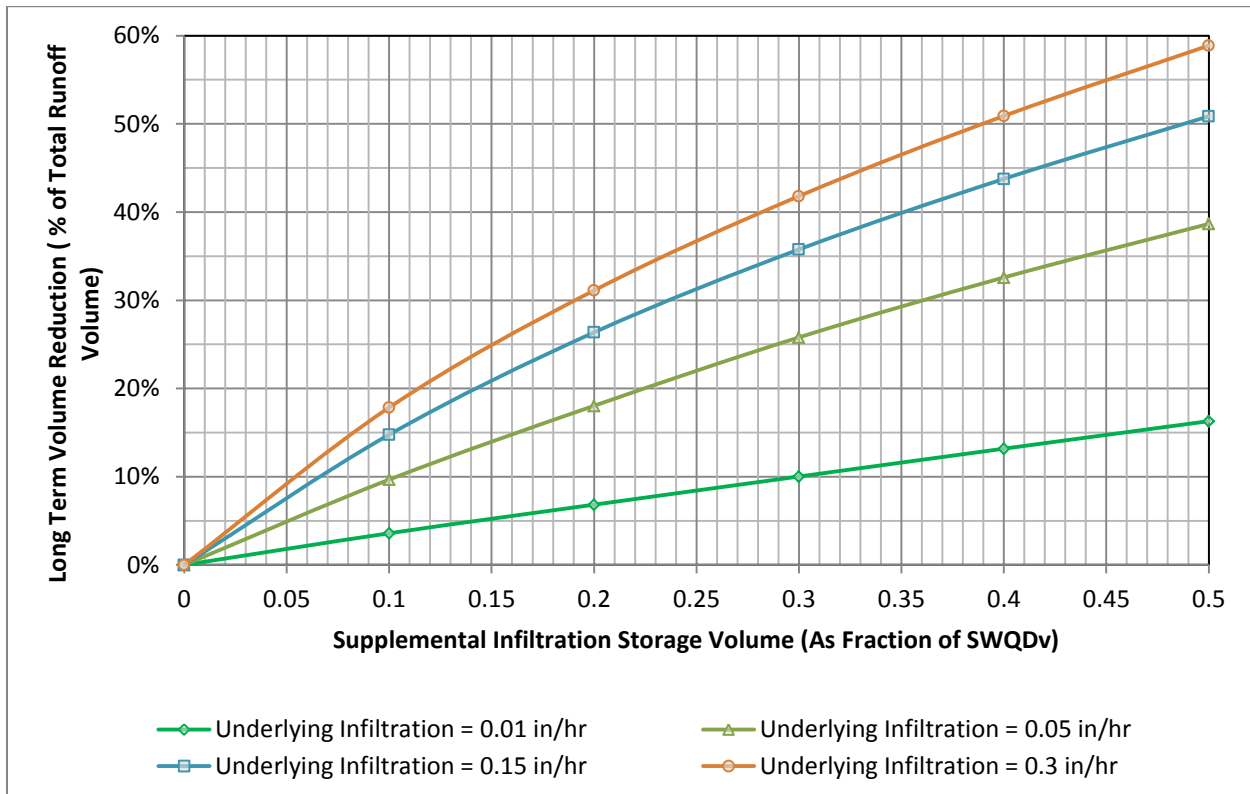

**Figure 3. Chart of Filtterra Capture Efficiency**

### 3.3.2 Volume Reduction (Filtterra and Supplemental Infiltration Storage)

Filtterra systems, sized within the range needed to match conventional biofiltration capture efficiency, were estimated to provide approximately 1 percent long term volume reduction via evapotranspiration from soil pores (determined from SWMM modeling described above). This relatively small value is a function of the relatively small surface area of typical Filtterra systems.

For site conditions in which conventional biofiltration BMPs would achieve appreciable volume reduction, supplemental infiltration systems (located either upstream or downstream of Filtterra systems) may be needed to result in volume reduction equal to what would be achieved by conventional biofiltration BMPs under the same site conditions. Volume reduction is a function of the storage volume provided, the surface area of the storage/soil interface, and the infiltration rate of the soil (and associated drawdown time of the stored water). As described in Appendix B, SWMM modeling was conducted to determine the long term volume reduction of supplemental infiltration storage as a function of storage volume (with a reasonable surface area) and soil infiltration rate (Figure 4). The supplemental retention volume is specified as a fraction of the site-specific SWQDv, which is a standardized calculation in each jurisdiction and accounts for different precipitation depths around Los Angeles County as well as infiltration rates. The design methodology (Section 4) also provides guidance about the allowable depth of the supplemental retention storage systems so that stored water will infiltrate in a reasonable amount of time.



**Figure 4. Chart of Volume Reduction in Supplemental Infiltration Storage**

### 3.3.3 Pollutant Treatment

Filtterra performance data were analyzed using the same moving window bootstrapping methods used for conventional biofiltration. Data from 6 third party studies conducted over the last 11 years (including some studies monitored periodically since 2007) were utilized in this analysis. This analysis sought to determine whether Filtterra performance is reasonably similar to the treatment performance of conventional biofiltration BMPs under representative ranges of influent quality. This analysis was based on the same pollutant and land uses described above for conventional biofiltration.

The following bullets summarize the comparison of pollutant concentration reduction for conventional biofiltration and Filtterra systems. Detailed comparison tables and plots are provided in Appendix D.

- **TSS:** Filtterra performed somewhat better than conventional biofiltration systems for TSS across all representative land use concentrations considered. Both systems showed relatively strong performance for TSS.
- **Copper and Zinc:** Performance was generally similar between Filtterra and conventional biofiltration for copper and zinc. Filtterra showed better performance for some representative influent concentrations and conventional biofiltration showed better concentration reductions for others. In general, both provided moderate concentration

reductions of metals. The sample size for Filtterra for sites with high metals concentrations is somewhat small, which results in wider confidence intervals for land uses with higher concentrations. Specifically, there was only one study (Port of Tacoma TAPE, station POT2) that had high zinc concentrations; this site was notable/unique in its high concentrations and the degree of dissolved zinc as a fraction of total zinc. For this site, average zinc influent concentrations were approximately 1,000 ug/L of which approximately 85 percent was dissolved zinc, on average. The concentration reductions for this site were still moderate (approximately 50 percent average removal).

- **Nitrogen and Phosphorus:** Filtterra systems appear to provide much better pollutant concentration reduction than conventional biofiltration for nitrogen and phosphorus. Filtterra does not appear to exhibit the export issues that were noted for conventional biofiltration within the representative range of land use concentrations considered. Variability in pollutant reduction performance was also lower for Filtterra.

Given these findings, Filtterra are expected to provide similar or better pollutant concentration reduction for all pollutants across the representative site conditions considered.

### ***3.3.4 Additional Capture In Lieu of Volume Reduction***

As described in Section 3.3.2 and Section 4, one approach for matching the pollutant load reduction of conventional biofiltration is to provide supplemental infiltration storage upstream or downstream of Filtterra systems to match the volume reduction that would be achieved by conventional biofiltration.

For Filtterra applications with minor deficiencies in volume reduction compared to conventional biofiltration, another option is to capture and treat additional long term runoff volume (via increased sizing) to achieve equivalent load reductions in lieu of providing supplemental infiltration storage. As a simple approach for minor volume reduction deficiencies, the pollutant treatment performance of Filtterra systems for TSS was used as a simple method. Based on a minimum removal efficiency of 80 percent (actual performance is expected to be higher), a BMP must treat and discharge 5 parts of water for every 4 parts of water that would be lost to infiltration or ET. This means that for every 1 percent of volume reduction deficit, 1.25 percent of long term volume must be treated or 0.25 percent additional capture for every 1 percent of volume reduction deficit. This concept is illustrated in Figure 5. Calculations of required additional capture efficiency are provided in Table 2.

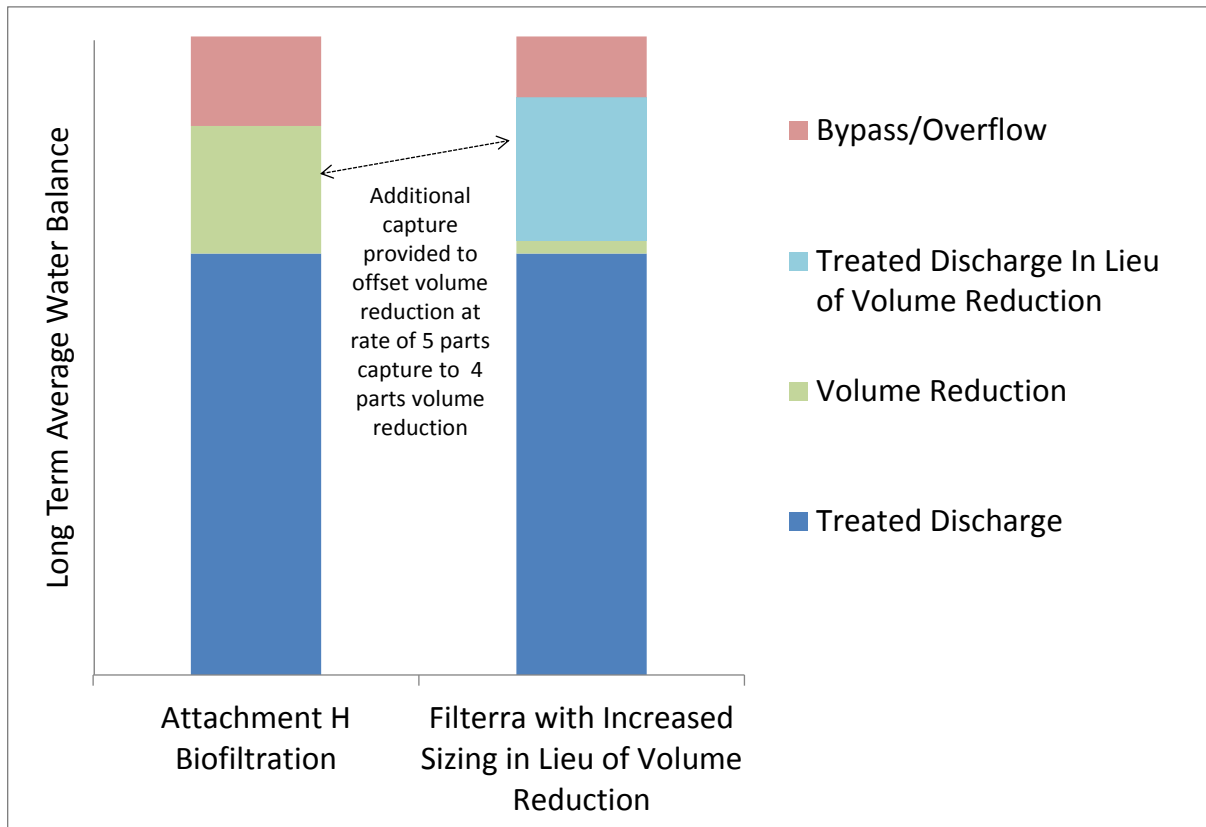

**Figure 5. Illustration of Additional Capture In Lieu of Volume Reduction (Not to scale)**

**Table 2. Additional Capture Efficiency in Lieu of Volume Reduction**

Site Soil Infiltration Rate, in/hr	Attachment H Biofiltration Long Term Volume Reduction <sup>1, 2</sup>	Filtterra Long Term Volume Reduction <sup>1</sup> (ET only)	Volume Reduction Deficit	Additional Capture Efficiency in Lieu of Volume Reduction <sup>3</sup>	Adjusted Target Capture Efficiency
0	4%	1%	3%	0.8%	93.8%
0.01	6%	1%	5%	1.3%	94.3%
0.05	11%	1%	10%	2.5%	95.5%
0.10	16.5%	1%	15.5%	3.9%	96.9%
0.15	22%	1%	21%	5.3%	98.3%
0.30	35%	1%	34%	8.5%	N/A

1 – Based on modeling of ET from soil pores and standing water.

2 – Includes infiltration losses, where feasible

3 – Required additional capture calculated at a rate of 1 part additional for every 4 parts volume reduction deficit.

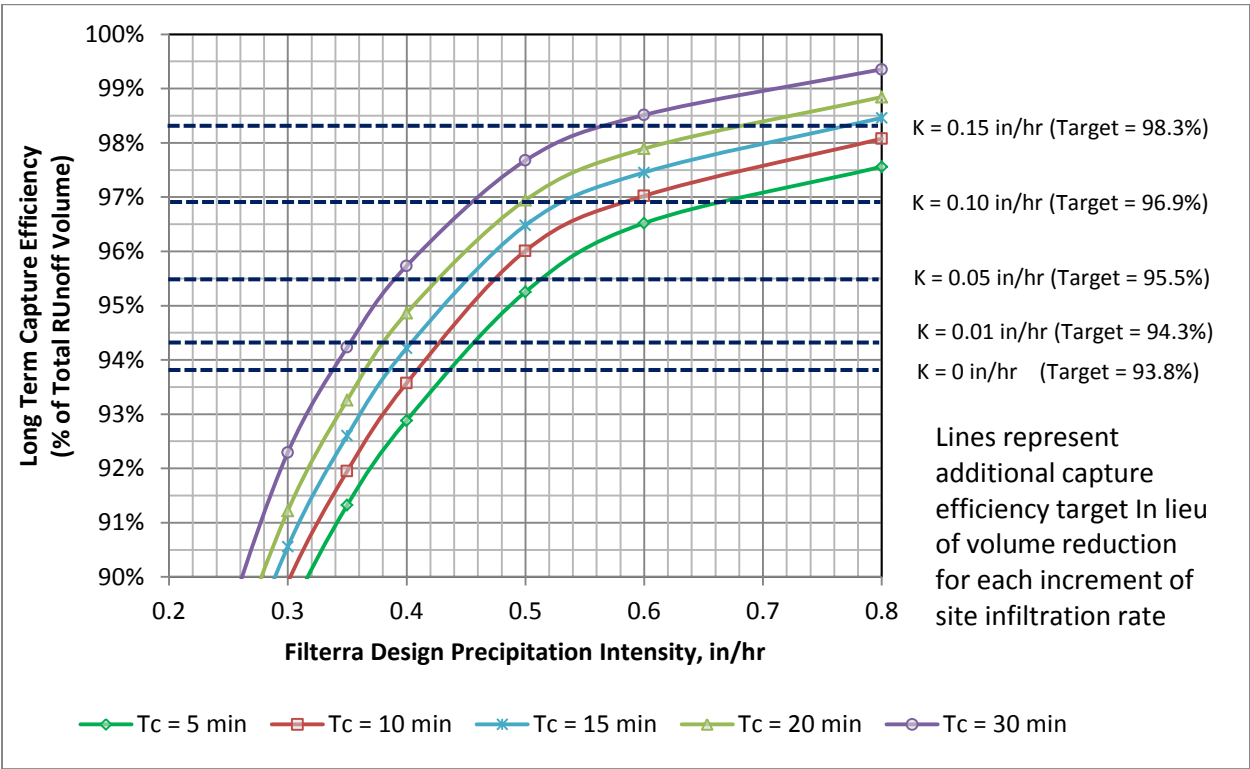

**Figure 6. Additional Capture Targets In Lieu of Volume Reduction (same chart as Figure 4, with adjusted axis limits)**

## 4 DESIGN METHODOLOGY AND EQUIVALENCY CRITERIA

In order to apply the equivalency relationships developed in Section 3, a standardized design methodology was developed. As a result of applying this design methodology, Filterra systems are expected to perform equivalently to conventional Attachment H biofiltration. This methodology consists of three parts, as described below.

### Part A - Characterize Site and Determine Key Attributes

1. Delineate the tributary area to each Filterra BMP.
2. Estimate the imperviousness of the tributary area; use this value to estimate a runoff coefficient for use in stormwater quality design flowrate (SWQDf) and stormwater quality design volume (SWQDv) calculations. The runoff coefficient shall account for imperviousness and be based on standard methods acceptable to the reviewing jurisdiction.
3. Calculate the time of concentration (Tc) for each Filterra tributary area using methods acceptable to the local jurisdiction.
4. Estimate the long term reliable infiltration rate of the soils underlying each BMP location using appropriate methods, subject to the approval of the reviewing agency.
5. Determine local 85<sup>th</sup> percentile, 24-hour precipitation depth for the project. The 85<sup>th</sup> percentile, 24-hour rain event shall be determined from the Los Angeles County 85<sup>th</sup> percentile precipitation isohyetal map<sup>2</sup> or analysis of local long term precipitation data.
6. Calculate the SWQDv for each Filterra tributary area, using locally-approved methods.
7. Calculate the site “Scaling Factor” as the ratio of the project-specific 85<sup>th</sup> percentile, 24-hour storm event to the LAX 85<sup>th</sup> percentile, 24-hour storm event (1.02 inches).

### Part B – Design Filterra for Equivalent Long Term Capture Efficiency

8. Consult Design Table 1 to determine the appropriate Filterra Design Precipitation Intensity associated with the Tc for each tributary area. For Tc less than 5 minutes, round up to 5 minutes. For Tc greater than 30 minutes, round down to 30 minutes. Interpolation between values in this table is permissible.

---

<sup>2</sup> [http://www.ladpw.org/wrd/publication/engineering/Final\\_Report-Probability\\_Analysis\\_of\\_85th\\_Percentile\\_24-hr\\_Rainfall1.pdf](http://www.ladpw.org/wrd/publication/engineering/Final_Report-Probability_Analysis_of_85th_Percentile_24-hr_Rainfall1.pdf)



**Design Table 1 - Filtterra Design Chart for Equivalent Long Term Capture Efficiency**

Time of Concentration of Tributary Area, minutes	Filtterra Design Precipitation Intensity, inches per hour <sup>1</sup>
5	0.41
10	0.38
15	0.36
20	0.34
30	0.32

1 - Sizing requirements are based on Filtterra size required to achieve a target capture efficiency of 93% of long term runoff volume at the Los Angeles Airport gage. For different locations, the site scaling factor must be applied.

9. Apply the rational method to determine the design flowrate required for each Filtterra.

$$Q_{required} = \text{Runoff Coefficient (unitless)} \times \text{Filtterra Design Precipitation Intensity (in/hr)} \times \text{Site Scaling Factor (unitless)} \times \text{Tributary Area (ac)} \times (43560 \text{ sq-ft/ac} / (12 \text{ in/ft} \times 3600 \text{ sec/hr}))$$

10. Select a Filtterra model with a treatment flow rate that is equal to or greater than the design flowrate based on a maximum treatment flow rate of 1.45 gallons per minute per square foot of Filtterra surface area. This is equivalent to a treatment rate of 140 inches per hour.

### **Part C, Option 1 - Design for Equivalent Long Term Volume Reduction**

The design of a Filtterra system must mitigate for deficiency in volume reduction compared to conventional biofiltration. As one option, the designer may include supplemental infiltration, either upstream or downstream of the Filtterra to compensate for the volume reduction deficit between conventional biofiltration and Filtterra systems.

11. Consult Design Table 2 to determine the fraction of the SWQDv that needs to be provided in supplemental retention. It is appropriate to linearly interpolate within this table. For long term reliable infiltration rates greater than 0.3 inches per hour, full infiltration of the SWQDv must be considered.

**Design Table 2 - Supplemental Infiltration Volume for Equivalent Long Term Volume Reduction**

Estimated Long Term Reliable Infiltration Rate below Site, inches per hour	Long Term Volume Reduction Deficit, % of Long Term Runoff	Required Supplemental Infiltration Storage Volume as Fraction of Local SWQDv, unitless <sup>1</sup>
0	3%	Not a feasible option; see Part C, Option 2
0.01	5%	0.15
0.05	10%	0.11
0.15	21%	0.17
0.3	34%	0.26

1 – Values are not expected to follow a continually increasing trend. A 2.1 foot effective depth is assumed for supplemental storage.

- Multiply the site-specific SWQDv for each Filterra Tributary area calculated above by the ratio from Design Table 2 to determine the required supplemental retention volume. Design Table 2 is based on the assumption that the Contech ChamberMaxx product will be used, with an equivalent storage depth of 2.1 feet. Shallower or deeper storage would require different sizing factors. Supplemental calculations can be provided to demonstrate that an alternative storage configuration would provide equivalent long term volume reduction.

**Part C, Option 2 - Design for Additional Capture In Lieu of Volume Reduction**

As an alternative option, the designer may increase the size of the Filterra systems to provide additional capture in lieu of providing supplemental infiltration volume.

- Consult Design Table 3 to determine the adjusted design precipitation intensity needed to compensate for volume reduction deficiency.

**Design Table 3 – Upsizing of Filterra to Provide Additional Capture Efficiency in Lieu of Volume Reduction**

Time of Concentration of Tributary Area, minutes	Site Infiltration Rate				
	0 in/hr	0.01 in/hr	0.05 in/hr	0.10 in/hr	0.15 in/hr
	Target Capture Efficiency = 93.8%	Capture Efficiency Target = 94.3%	Capture Efficiency Target = 95.5%	Capture Efficiency Target = 96.9%	Capture Efficiency Target = 98.3%
Adjusted Filterra Design Precipitation Intensities, in/hr					
5	0.44	0.46	0.52	0.66	NA
10	0.41	0.43	0.48	0.58	NA
15	0.39	0.41	0.45	0.53	0.76
20	0.37	0.38	0.43	0.50	0.68
30	0.34	0.35	0.39	0.46	0.56

NA = additional capture is not a viable option to offset volume reduction in these cases.

14. Apply the rational method to determine the adjusted design flowrate required for each Filtterra.

$$Q_{required} = \text{Runoff Coefficient (unitless)} \times \text{Adjusted Filtterra Design Precipitation Intensity (in/hr)} \times \text{Site Scaling Factor (unitless)} \times \text{Tributary Area (ac)} \times (43560 \text{ sq-ft/ac} / (12 \text{ in/ft} \times 3600 \text{ sec/hr}))$$

15. Select a Filtterra model with a treatment flow rate that is equal or greater than  $Q_{required}$  based on a maximum treatment flow rate of 1.45 gallons per minute per square foot of Filtterra surface area (140 inches per hour).

## 5 DISCUSSION AND CONCLUSIONS

### 5.1 Key Observations and Findings

This analysis and associated research yielded a number of key observations:

- The baseline level of capture efficiency and volume reduction provided by conventional biofiltration BMPs, if effectively designed per Attachment H, is relatively high. This establishes a relatively high baseline standard for Filtterra systems to meet in providing equivalent performance.
- There is substantial leeway within the Attachment H criteria and local implementation guidance that is expected to result in design variations of conventional biofiltration throughout Los Angeles County. These variations are expected to result in fairly important variations in hydrologic performance. Additionally, variations in operations and maintenance conditions over time (i.e., decline in media rates, reduction in active storage volume from sedimentation) are also expected to influence performance.
- It is possible to design Filtterra systems to match the capture efficiency of conventional biofiltration BMPs. This requires larger sizes of Filtterra systems than was required for treatment control BMPs under the previous MS4 Permit. This also requires a commitment to regular maintenance consistent with Filtterra standard maintenance requirements.
- Filtterra systems alone are not expected to match the volume reduction performance provided by conventional biofiltration that is effectively designed, even in lined systems. However, it is possible for Filtterra systems to mitigate for deficiency in volume reduction via either supplemental infiltration storage or increasing the size of Filtterra systems to increase their capture efficiency thereby providing equivalent load reductions.
- For water that is treated and released, Filtterra performance studies generally showed similar or better concentration reduction compared to conventional biofiltration. Filtterra performance tended to be less variable in most cases. Filtterra systems also did not exhibit the potential for major nutrient export that is relatively common in conventional biofiltration.
- When studies from the International BMP Database were screened to best match conventional biofiltration designs per Attachment H (specifically compost and sand fractions), the treatment performance tended to decline somewhat. This is consistent with findings related to use of compost in biofiltration media from other studies. This indicates that there is still progress to be made in addressing nutrient export issues in conventional biofiltration systems. For example, in Western Washington results of rigorous testing of media comprised of sand and compost conforming to local specifications have led to limitations on the use of biofiltration in nutrient sensitive watersheds and have stimulated research into alternative media blends.

Overall, if Filtterra systems are designed based on the methodology and criteria presented in Section 4 and effectively operated and maintained these systems are expected to match or exceed the performance of conventional biofiltration within a reasonable margin of uncertainty.

## 5.2 Reliability and Limitations

There are a number of uncertainties that influence the reliability of the findings presented in this report. These are addressed in the paragraphs below.

**Modeled hydrologic performance estimates.** Performance estimates were based on models which were not calibrated. This introduces some uncertainty. This uncertainty was mitigated by applying identical input parameters and modeling approaches for conventional biofiltration and Filtterra systems, as appropriate. This has the effect of offsetting the majority of potential sources of bias.

**Treatment performance estimates for conventional biofiltration.** Treatment performance estimates were based on peer reviewed studies from the International BMP Database and other peer reviewed third party studies that were selected to be representative of the BMPs being compared. Due to limited sample size of conventional biofiltration monitoring studies and some deficiencies in documentation of these studies, it was not possible to quantitatively evaluate whether performance estimates are specifically representative of Attachment H biofiltration. Additionally, performance has been observed to vary greatly from site to site, indicative of the importance of design factors such as sizing, media composition, sources of media components, and other design factors. The screened and unscreened datasets analyzed are believed to provide reliable information about the range of potential performance that may be expected from conventional biofiltration in Los Angeles County; however they are not intended to be used as a predictive tool for any one variation of biofiltration design. Reliability of these data was improved through the application of robust statistical methods that account for the influence of influent concentration and provide a quantification of uncertainty.

**Treatment performance estimates for Filtterra systems.** Filtterra systems have been evaluated in a range of sites and climates; however none of these sites were in Los Angeles and not all studies are necessarily representative of the influent quality from typical Los Angeles land uses. Additionally, the sample size of Filtterra datasets is still somewhat low in comparison to conventional biofiltration BMPs. These factors are mitigated to a large extent by the standardized design that accounts for rainfall intensity/duration differences and ensures consistency in media composition of Filtterra systems. These factors improve the transferability of findings between regions. Additionally, the reliability of Filtterra performance data was improved by applying the same robust statistical methods as used for conventional biofiltration, which help adjust for differences in influent quality between studies.

**TSS removal as a surrogate for additional capture in lieu of volume reduction.** For small deficiencies in volume reduction, a TSS treatment removal rate of 80 percent was used to calculate required additional capture efficiency in lieu of volume reduction. A multi-parameter approach would be more complex and would need to account for the export of nutrients in conventional biofiltration as well as the observation that metals performance

tends to vary substantially with influent concentration (i.e., where influent concentration is relatively low, the removal efficiency tends to be lower, but the resulting effluent concentration is still below typical water quality standards). Given that this approach is only intended to offset minor volume reduction (up to about 20%), this is considered to be a reasonable approach.

**Sensitivity to site conditions.** The effectiveness of volume reduction processes is particularly sensitive to estimates of site infiltration rate. It may not be possible to anticipate, with certainty, what the final long term infiltration rate will be in the post construction condition. This limitation is largely mitigated for the purpose of this analysis because the uncertainty in infiltration rate influences the design and performance of conventional biofiltration and Filterra with infiltration storage similarly. Additionally, estimating the site infiltration rate is now a standard part of developing a BMP plan for a site, therefore approaches for developing this estimate should improve in reliability with time. Finally, both systems provide excellent TSS treatment prior to infiltration and long term infiltration rates should therefore be more reliable.

**Variability in design and construction process.** The analyses and criteria presented in this report are based on the assumption that the BMPs will be effectively designed and constructed consistent with a typical standard of care. It is inherent that design of non-proprietary conventional biofiltration BMP provides a greater degree of freedom and associated professional judgment as part of preparing design calculations, design drawings, and specifications. This introduces a wider potential range of resulting designs. Some may be better than average, some may be worse. Additionally, there are typically a number of specialized elements in the construction of a biofiltration BMP that may introduce variability in as-built condition as a result of contractor preferences and/or quality control issues. There are many examples of biofiltration facilities that have failed due to design and construction issues. In comparison, there is likely to be substantially less variability in the design and construction of Filterra system compared to biofiltration BMPs.

**Sensitivity to operations and maintenance.** Both types of systems are susceptible to decline in performance over time. **Neither system will work if they are not regularly and effectively maintained.** Filterra systems may be more susceptible to rapid clogging because of their relatively small footprint. However, this is mitigated by Filterra having a standard maintenance plan that has been informed by feedback from O&M of numerous facilities.

Overall, the analyses are believed to result in reliable design assumptions. Where substantial uncertainties exist, the analyses and assumptions have tended to err on the side of estimating somewhat higher performance for conventional biofiltration and somewhat lower performance for Filterra systems, which likely results in more conservatism in Filterra equivalency sizing.

## 6 REFERENCES

- Americast, Inc. 2009a. Filtterra® Flow Rate Longevity Verification Study. May 2009.
- Americast, Inc. 2009b. Filtterra® Long Term Field Performance Evaluation Report. April 2009.
- ATR Associates. 2009. Technical Report Addendum. Additional Field Testing and Statistical Analysis of the Filtterra® Stormwater Bioretention Filtration System. Prepared for Americast, Inc. by Richard Stanford, ATR Associates, Inc., Strasburg, Virginia. January 26, 2009.
- Automated surface Observing System (ASOS). (2015). <ftp://ftp.ncdc.noaa.gov/pub/data/asos-fivemin/>.
- California Department of Water Resources (CDWR). (2015). California Irrigation Management Information System (CIMIS). Website: <http://www.cimis.water.ca.gov/>.
- David N., Lent, M., Leatherbarrow, J., Yee, D., and McKee, L. (2011). Bioretention Monitoring at the Daly City Library. Final Report. Contribution No. 631. San Francisco Estuary Institute, Oakland, California.
- Davis, A. P. (2007). "Field Performance of Bioretention: Water Quality." *Environ. Eng. Sci.* 2007, 24, 1048–1063.
- Davis, A., Traver, R., Hunt, W., Lee, R., Brown, R., and Olszewski, J. (2012). "Hydrologic Performance of Bioretention Storm-Water Control Measures." *J. Hydrol. Eng.*, 17(5), 604–614.
- Gilbreath, A. N., Pearce, S. P. and McKee, L. J. (2012). Monitoring and Results for El Cerrito Rain Gardens. Contribution No. 683. San Francisco Estuary Institute, Richmond, California.
- Herrera (2009). Filtterra Bioretention Filtration System Performance Monitoring Technical Evaluation Report. Prepared for Americast, Inc. by Herrera Environmental Consultants, Inc., Seattle, Washington. December 3, 2009.
- Herrera (2014a). Technical Evaluation Report: Filtterra System Phosphorus Treatment and Supplemental Basic Treatment Performance Monitoring. Prepared for: Americast, Inc. (as art of TAPE Process) by Herrera Environmental Consultants, Inc., Seattle, Washington. February 12, 2014
- Herrera (2014b). Final Report: 185th Avenue NE Bioretention Stormwater Treatment System Performance Monitoring. Prepared for City of Redmond, by Herrera Environmental Consultants, Inc., Seattle, Washington. March 6, 2014.
- Herrera (2015a). Interim Project Report: City of Redmond Six Bioretention Swales Monitoring. Prepared for City of Redmond, by Herrera Environmental Consultants, Inc., Seattle, Washington. February 20, 2015
- Herrera (2015b). Analysis of Bioretention Soil Media for Improved Nitrogen, Phosphorous and Copper Retention, Final Report, Prepared for Kitsap County by Herrera Environmental Consultants, Seattle, WA, July 17, 2015.
- Geosyntec Consultants and Wright Water Engineers (2009). Urban Stormwater BMP Performance Monitoring. Prepared by Geosyntec Consultants and Wright Water Engineers, Inc. Prepared under Support from U.S. Environmental Protection Agency, Water Environment Research Foundation, Federal Highway Administration, Environmental and

- Water Resources Institute of the American Society of Civil Engineers. October 2009. <http://www.bmpdatabase.org/Docs/2009%20Stormwater%20BMP%20Monitoring%20Manual.pdf>
- Los Angeles County (LA County), 2000. Los Angeles County 1994-2000 Integrated Receiving Water Impacts Report.
- Los Angeles County (LA County), 2001. Los Angeles County 2000-2001 Stormwater Monitoring Report.
- Los Angeles County (LA County), 2006. Los Angeles County Hydrology Manual, Department of Public Works (LACDPW), Alhambra, California
- Larry Walker Associates and Geosyntec Consultants, 2011. Ventura County Technical Guidance Manual for Stormwater Quality Control Measures. July 2011.
- Leisenring, M., Poresky, A., Strecker, E., and M. Quigley, 2009. Evaluating Paired BMP Influent and Effluent Data Using Running Bootstrap Medians. Proceedings of the American Water Resources Association Annual Conference, Seattle WA, November 9-12, 2009.
- Li, H. and Davis, A. (2009). "Water Quality Improvement through Reductions of Pollutant Loads Using Bioretention." J. Environ. Eng., 135(8), 567–576.
- National Climatic Data Center (NCDC). (2015). [ftp://ftp.ncdc.noaa.gov/pub/data/hourly\\_precip-3240/](ftp://ftp.ncdc.noaa.gov/pub/data/hourly_precip-3240/).
- North Carolina State University 2015. Filtterra Bioretention System Sediment Removal and Hydrologic Performance Evaluation Report, Fayetteville Amtrak Filtterra® Prepared for: Filtterra® Bioretention Systems. August 28, 2014. Prepared by Andrew Anderson and Andrea Smolek.
- Rosen, R.M. and Stone, R.M. (2013). Bioretention Water Quality Treatment Performance Assessment. Technical Memorandum. Prepared for Seattle Public Utilities.
- Singh, K. and Xie, M. (2008) Bootstrap: a statistical method. Rutgers University.
- Yu and Stanford. 2006. Field Evaluation of the Filtterra® Stormwater Bioretention Filtration System. A Final Technical Report. Prepared for Americast, Inc. by Dr. Shaw L. Yu and Richard L. Stanford, Department of Civil Engineering, University of Virginia. May 24, 2006.
- Washington State Department of Ecology. 2014. 2012 Stormwater Management Manual for Western Washington (as Amended in 2014. Publication Number 14-10-055.



## **APPENDIX A – CONVENTIONAL BIOFILTRATION DESIGN ASSUMPTIONS FOR PERFORMANCE MODELING**

The following criteria from Attachment H were considered to be important for evaluating pollutant load reduction performance of “conventional biofiltration” scenarios:

- 6 to 18-inch ponding area above media
- Optional layer of mulch
- 2 to 3 feet of engineered filter media (2 feet typical) with a design infiltration rate of 5 to 12 inches/hour; the Attachment H specification calls for a mix of 60 to 80% fine sand and 20 to 40% compost
- Gravel storage layer below the bioretention media to promote infiltration
- Underdrain placed near the top of the gravel layer (or an infiltration sump otherwise provided via an equivalent hydraulic control approach) in cases where underlying soil infiltration rates allow
- Underdrain discharge to the storm drain
- Total physical water storage volume sized to be equal to at least the stormwater quality design volume (SWQDv = runoff volume from the 85<sup>th</sup> percentile, 24-hour storm event)
- Capacity (including stored and filtered water) adequate to biofilter 150 percent of the portion of the SWQDv not reliably retained.

Within the bounds established by these criteria, a relatively wide range of actual biofiltration designs could result as a function of site infiltration conditions as well as designer and local jurisdiction preferences. An example of potential design variability is illustrated in Table A.1 below. For the purpose of this analysis, representative design assumptions were developed within the range of potential design assumptions. These assumptions are also presented in Table A.1 with supporting rationales.

**Table A.1 Biofiltration Design Assumptions from Various Sources and Selected Representative Design Assumptions**

Design Assumption	Design References					Selected Representative Design Assumption	Rationale for Selected Design Assumption
	MS4 Permit Attachment H	Los Angeles County LID Manual, static method	Los Angeles County LID Manual, routing method	City of Los Angeles LID Manual	Ventura County TGM		
Ponding Depth, ft	0.5 to 1.5	0.5 to <b>1.5</b>	0.5 to <b>1.5</b>	0.5 to <b>1.5</b>	0.5 to <b>1.5</b>	1.5	Many designers will utilize deepest depth allowable because of space efficiency.
Media Depth, ft	2 to 3	<b>2</b> to 3	<b>2</b> to 3	<b>2</b> to 3	<b>2</b> to 3	2	Typical design approach is to use minimum depth due to cost of media.
Gravel “sump” depth below underdrain, ft	Not specified; narrative	Not specified, narrative	Not specified, narrative	At least 1 feet; up to <b>2</b> feet if soils allow incidental infiltration	<b>0.5</b> minimum below underdrain	Depth that would drain in 24 hours. For example, 1.5 ft if site infiltration rate estimated at just less than 0.3 in/hr	Approach produces a reasonable design that considers infiltration rates; Attachment H states that volume infiltrated within 24 hours can be considered retained.
Media Filtration Rate, in/hr	5 to 12	<b>5</b> to 12	<b>5</b> to 12	<b>5</b> to 12	1 to 12 ( <b>5</b> )	5	Representative of long term operation after some clogging
Allowable Routing Period for Biofiltration Treatment, hrs	Not specified	Routing is not part of simple method	Allows routing of <b>24-hour</b> design hydrograph from LA County HydroCalc model	<b>3</b> hours, unless using a routing model	Depth up to ponding depth ( <b>1.5 ft</b> ) can be considered routed	6 hours <sup>1</sup>	Based on evaluation of storm durations for events similar to design event. See footnote 1.
Resulting Footprint Factor at 0.3 in/hr Infiltration Rate, in/hr (% of impervious area)	Not enough information to calculate	7.5%	1.4%	2.4% (1.4% with routing similar to LA County)	2.8%	2.0%	Calculated based on assumptions.

Note: where a range of guidance is allowed, the bolded number indicates the value that was used in calculations. The design values were selected based on developing the most economical and space-efficient design that meets the applicable criteria.

1 – The allowable routing period was estimated based on the typical storm duration associated with events similar to the 85<sup>th</sup> percentile, 24-hour storm depth (1.0 inches at LAX). This was estimated in two ways. For days with precipitation totals between 0.9 and 1.1 inches, the total number of hours with rainfall was tabulated (average = 11 hours; 10<sup>th</sup> percentile = 6 hours). This does not consider dry periods between hours with rainfall, therefore is somewhat conservative in estimating the period of time available for routing biofiltered water during a given day. For unique precipitation events, separated by 6 hour dry period (potentially spanning across breaks in calendar days), with precipitation totals between 0.9 and 1.1 inches, the total storm durations were tabulated (average = 16 hours; 10<sup>th</sup> percentile = 7 hours). Based on this analysis, a 6 hour routing period is considered to be defensible and conservative in estimating the amount of water that can be routed through a biofiltration system during typical storm events similar to the design storm event.

## **APPENDIX B – SWMM MODELING METHODOLOGY AND ASSUMPTIONS**

### **Equivalency Scenarios**

The relative performance of Filterra systems and conventional biofiltration was compared under the following climate and site conditions:

- Climate (and associated precipitation and ET): Los Angeles
- Land Use (and associated imperviousness and runoff quality): Multi-family Residential
- Soil infiltration rate: 0, 0.01, 0.05, 0.15, and 0.3 inches per hour
- A hypothetical 1-acre catchment was used for this analysis and was not varied.

For conventional biofiltration, the sizing and design criteria described in Appendix A were followed.

For Filterra systems, all combinations of the following sizing criteria were evaluated for each combination of climate and site conditions:

- Design precipitation intensity: 10 sizing increments were evaluated between 0.1 and 0.8 inches per hour.
- Catchment time of concentration: 5 increments were evaluated between 5 minutes and 30 minutes
- Downstream retention storage volume: 5 increments were evaluated between 0% (absent) and 50% of the runoff from the 85<sup>th</sup> percentile, 24-hour storm event.

Specific SWMM modeling representations of each combination of site conditions and BMP parameters are described in this Appendix.

### **Overview of SWMM Analysis Framework**

SWMM was used to estimate the long-term capture efficiency and volume reduction from conventional biofiltration BMPs and Filterra systems for each scenario. SWMM compartmentalizes its computations based on several physically-based processes including surface runoff, evaporation, infiltration, and flow routing. A conceptual representation of the SWMM model framework used for this analysis is provided in Figure B.1. Within this framework, parameters were adjusted for each scenario to account for soil condition and BMP sizing and design attributes.

In SWMM, subcatchment elements are used to generate a runoff hydrograph. Input data defining the surface characteristics include subcatchment area, imperviousness, width, depression storage, surface roughness, surface slope, and infiltration parameters. SWMM performs a mass balance

of inflows and outflows to determine runoff from a subcatchment. The inflows to this mass balance are precipitation and any runoff directed from another subcatchment. The outflows from the mass balance include evaporation, infiltration, and runoff. The runoff parameters assumed for this analysis are discussed in this Appendix.

A variety of hydraulic flow routing elements exist in SWMM, but fundamentally, the program includes nodes (i.e., storage units, manholes, and outfalls) and links (i.e., conduits, pipes, pumps, weirs, orifices, and outlets). Storage units were used in this equivalency analysis to represent the storage and routing attributes of BMPs. The elements defining the storage volume and related discharge were adjusted based on the various sizing and design criteria evaluated in the equivalency scenarios, the details of which are discussed in this Appendix.

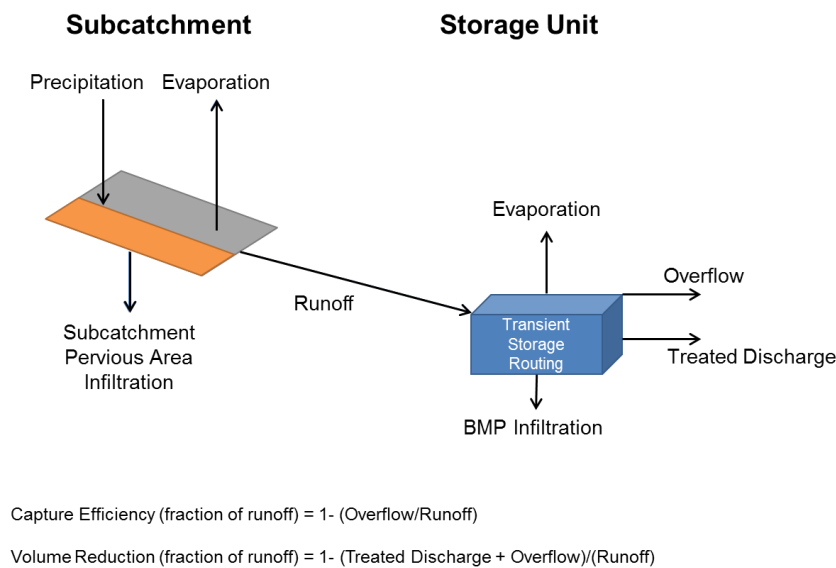

**Figure B.1. Schematic SWMM modeling framework in support of equivalency analysis**

SWMM was run in continuous simulation mode over a 15-year period (2000-2015). A continuous hydrograph of runoff was generated and routed through the model representations of BMPs. The results were tracked and reported in terms of long term runoff volume, long term volume lost in the BMP, long term volume bypassing or overflowing the BMP, and long term volume treated in the BMP. The 15-year period of record was selected based on the availability of high quality 5-minute resolution precipitation data, which are important for representing urban catchments with short time of concentration. To ensure comparability, the same forcing data (rainfall, ET) were applied to conventional biofiltration scenarios and Filtterra scenarios.

**Meteorological Inputs**

***Precipitation***

Precipitation data utilized this study included continuous hourly precipitation data collected by the National Climatic Data Center (NCDC) and five-minute precipitation data from the Automated Surface Observation System (ASOS); both part of the National Oceanic and Atmospheric Administration (NOAA). The hourly precipitation datasets from NCDC provided an extensive record of precipitation data from 1948 through February 2015. NCDC precipitation datasets at major airports are known to be of high quality with few areas of missing or unreportable data and therefore were used as a quality standard to compare to the ASOS dataset as well as the basis for estimating long term precipitation statistics. The ASOS dataset does not receive the same level of quality review that the NCDC data and has considerably shorter period of data (ASOS dataset is from 2000 to February 2015). However, the ASOS data is collected at 5-minute intervals, providing considerably better temporal resolution for precipitation when modeling of urban BMPs, particularly for small catchments. Therefore, NCDC data were used to define the 85<sup>th</sup> percentile 24-hour sizing criteria and to validate the ASOS data, while the ASOS data was used as the input to comparative model simulations. The period of record of ASOS data (15 years) is less than ideal for characterizing long term averages, however because the same dataset was used for both conventional biofiltration and Filterra systems, this length of record is ample to provide a valid comparison of performance.

The Los Angeles Airport location was included in this analysis (NCDC: 045114, ASOS: KLAX). The 85<sup>th</sup> percentile 24-hour precipitation depth was determined using the entire length of record at the NCDC gage and compared to the values produced from the ASOS gages (Table B-1). In determining the 85<sup>th</sup> percentile, 24-hour depth, days with 0.1 inches or less were excluded from both datasets. The resulting 85<sup>th</sup> percentile, 24-hour depths are well matched between the NCDC and ASOS gage. Scatter plot comparisons of NCDC and ASOS datasets for monthly and 24-hour totals at each location also show good agreement (Figure B-1 and Figure B-2). This indicates that the ASOS data provide a reasonable estimate of absolute long term performance in addition to providing a reliable comparison between BMP types.

**Table B.1. Summary of 85<sup>th</sup> percentile 24-hour storm depths.**

<b>Storms</b>	<b>Gage Location</b>	<b>85<sup>th</sup> Percentile 24-Hour Depth (in)</b>
All NCDC Storms > 0.1 inch (1948-2015)	Los Angeles Airport (045114)	1.01
All ASOS Storms > 0.1 inch (2000-2015)	Los Angeles Airport (KLAX)	0.96

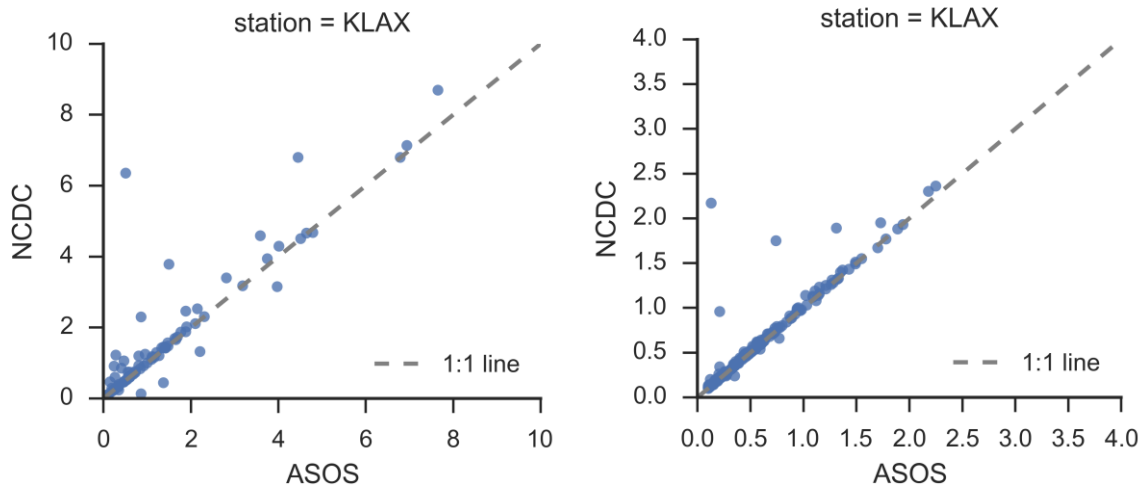

**Figure B.2. Scatter plot comparisons of monthly (left) and daily (right) precipitation depths for NCDC and ASOS datasets.**

***ET Parameters***

Reference ET values for Zone 4 of the California Irrigation Management Information System were used to estimate evaporation for all simulations (CDWR 2015). Zone 4 represents coastal areas; actual ET may be higher in inland areas and is likely higher on average in Southern California than the San Francisco Bay Area, however the influence of this assumption is minor and will tend to cancel out in comparison between BMP types. Average ET conditions were represented by setting the modeled evaporation values equal to 60% of the reference ET values to represent a mix of urban conditions with varied plant pallets and shading conditions based on guidance provided by CIMIS (CDWR 2015). The assumed ET values for this analysis are presented in Table B.2.

**Table B.2. Assumed ET values for all scenarios**

Month	Evapotranspiration Rates			60%
	inch / day	days / month	inch / month	inch / month
January	0.05	31	1.55	0.93
February	0.08	28	2.24	1.34
March	0.12	31	3.72	2.23
April	0.17	30	5.1	3.06
May	0.22	31	6.82	4.09
June	0.26	30	7.8	4.68
July	0.28	31	8.68	5.21
August	0.25	31	7.75	4.65

Month	Evapotranspiration Rates			60%
	inch / day	days / month	inch / month	inch / month
September	0.19	30	5.7	3.42
October	0.13	31	4.03	2.42
November	0.07	30	2.1	1.26
December	0.05	31	1.55	0.93
Total (year)		365	57.04	34.22

### **Runoff Parameters**

The key SWMM parameters used to estimate surface runoff are subcatchment area, width, imperviousness, depression storage, surface roughness, surface slope, and infiltration parameters. The majority of surface characteristics were kept constant for both BMP systems and across all land use types. The values assumed for each of these parameters are in Table B.3. Imperviousness was varied for different land uses as described in the Ventura County Technical Guidance Manual for Stormwater Quality Control Measures (Larry Walker Associates and Geosyntec 2011) and is presented for each land use within Table B.3. Additionally, for Filterra simulations, the width parameter (defines the overland flow length for runoff to travel), were adjusted to reflect differences in time of concentrations. The values applied within the model were estimated through an iterative process during the modeling phase.

Runoff estimation is affected by losses to infiltration processes over pervious areas of the subcatchment. The Green-Ampt method of estimating infiltration was used to represent this process. Three input parameters were used to characterize infiltration with this method: initial deficit, saturated hydraulic conductivity, and suction head. These parameters represent surface conditions and are not necessarily related to the saturated infiltration processes that may occur below a BMP (typically several feet below the surface). Because the purpose of this equivalency analysis was to isolate differences between two BMP types, the subcatchment infiltration parameters were held fixed for all scenarios. Parameters were selected to represent typical urban conditions with disturbed urban soils (Table B.3).

**Table B.3. Summary of SWMM parameters to represent runoff parameters**

SWMM Runoff Parameters	Units	Values	Source/Rationale
Wet time step	seconds	150	Set to half the time steps of precipitation input data (300 seconds)
Dry time step	seconds	14,400	Equivalent to 4 hours.
Period of Record		January 2000-December 2014	Availability of ASOS data

<b>SWMM Runoff Parameters</b>	<b>Units</b>	<b>Values</b>	<b>Source/Rationale</b>
Percent of Impervious Area	percent	Multifamily Residential = 74	Los Angeles County Hydrology Manual (2006)
Impervious Manning's n	unitless	0.012	James and James, 2000
Pervious Manning's n	unitless	0.15	James and James, 2000 (mix of dense grass and mulched landscaping)
Drainage area	acres	1	Hypothetical for purpose of analysis
Width	feet	174 feet by default (equates to 250-ft path length) For Filterra scenarios, variable to represent different time of concentrations	Typical assumption for urban drainage patterns
Slopes	ft/ft	0.03 (represents average of roofs, landscaping, and streets)	Professional judgment
Evaporation	in / month	60% of reference ET values (Table B.4)	CIMIS (CWDR, 2015)
Depression storage, impervious	inches	0.02	James and James, 2000
Depression storage, pervious	inches	0.06	James and James, 2000
Saturated Hydraulic Conductivity (in/hr)	in/hr	0.15	EPA SWMM User's Manual for typical disturbed urban soils
Initial Moisture Deficit (in/in)	in/in	0.29	EPA SWMM User's Manual for typical disturbed urban soils
Maximum Suction Head (inches)	inches	8	EPA SWMM User's Manual for typical disturbed urban soils

### **BMP Representation**

Both the conventional biofiltration BMPs and Filterra systems were simulated using a storage unit with outlets to represent infiltration losses (if present) and treated discharge, and a weir to represent overflow/bypass. The elevations of these elements within the storage unit were used to represent the design profiles of these systems. Storage compartments were broken into: evaporation storage (i.e., water stored in soil that is not freely drained); infiltration storage (i.e., water stored below the lowest outlet that can either infiltration or ET only); and freely drained storage (i.e., water that can drain through the underdrains of the system at a rate controlled by the



media hydraulic conductivity). In some scenarios an additional storage unit was located downstream of the Filtterra BMP to represent additional retention storage.

### ***Conventional Biofiltration***

Sizing criteria for the conventional biofiltration system was based on the runoff from the 85<sup>th</sup> percentile, 24-hour storm depth (1.0 for LAX). For each scenario, this depth was applied to the catchment area and imperviousness to compute an estimated runoff volume. Storage profiles for the conventional biofiltration system were established to represent typical profiles for conventional biofiltration consistent with what is required by Attachment H of the MS4 Permit, which are presented in Appendix A. The storage profiles included equivalent storage volumes provided in the ponding depth, media depth (divided between ET storage and freely drained storage), gravel layer, and placement of the underdrain system specific to the site conditions. Based on the equivalent storage depth in these profiles and the design storm runoff volume, the required footprints were calculated. For gravel, a porosity of 0.4 was assumed. For media, a porosity of 0.4 in/in was assumed, divided as 0.15 in/in soil suction storage (i.e. ET storage) and 0.25 in/in freely drained storage. The profiles used for this analysis and the typical footprints are presented in Table B.4.

For the purpose of estimating long term volume reduction and baseline capture efficiency, the entire pore volume was assumed to be immediately available. However, because water takes time to travel through the soil column, it is possible for a biofiltration BMP to overflow before the entire soil pore volume is utilized. Based on analysis of flow monitoring data, Davis et al. (2011) found that the volume immediately available within a storm is better represented by the bowl volume (surface ponding) and the freely drained pores within the root zone (approximately the top 1 foot of soil). To check whether this condition controlled, parallel model runs were conducted where the storage volume equaled the bowl volume plus freely drained pores in the soil root zone, and the drawdown time was adjusted for only this volume. The result was that this condition reduced capture efficiency by approximately 2 percent. This indicates that this condition controls performance relatively rarely, but is not negligible.

**Table B.4. Summary of conventional biofiltration profiles**

Infiltration Rate, in/hr	Retention Sump Depth (as gravel depth) <sup>1</sup> , ft	Effective Water Storage in Retention Sump (ft)	Media Depth, ft	Effective Water Storage in Media <sup>2</sup> , ft	Ponding Depth, ft	Total Effective Water Depth (ft)	Approximate Footprint Sizing Factor (Los Angeles) <sup>3</sup>
0.3	1.5	0.60	2	0.8	1.5	2.9	1.5%
0.15	0.75	0.30	2	0.8	1.5	2.6	1.6%
0.05	0.25	0.10	2	0.8	1.5	2.4	1.7%
0.01	0.05	0.02	2	0.8	1.5	2.32	1.7%
0	0	0.00	2	0.8	1.5	2.3	1.8%

1 Sump storage was determined based on the depth of water that would infiltrate in 24 hours based on guidance provided in Attachment H.

2 Media storage depth divided as 0.3 ft suction storage and 0.5 ft freely drained storage.

3 Expressed as BMP footprint as percent of tributary area; Multi-family density of 74% impervious was used as a representative value for simulations.

### ***Filterra***

An array of flow-based sizing increments were applied to define the physical dimensions of the Filterra system to be modeled in each scenario. Ten increments of uniform design intensities ranging from 0.1 inches/hour up to 0.8 inches/hour (0.1, 0.15, 0.2, 0.25, 0.3, 0.35, 0.4, 0.5, 0.6, 0.8) were established to represent a range of potential Filterra sizing criteria to achieve equivalency. For each scenario, the design intensity was applied to the catchment area and imperviousness to calculate the runoff flowrate. The treatment capacity of the Filterra system was set at 140 in/hr (or 0.0032 cu-ft/sec per sq-ft). Based on the required treatment flowrate and the Filterra treatment capacity, the required Filterra footprint was determined.<sup>3</sup> Similar to the conventional biofiltration system, a vertical profile was also established as an input to the model, including ponding depth, pore space in mulch and media, and underdrains (Table B.5). The volume of the Filterra system is negligible; however the entire volume was assumed to be available as a result of the very high infiltration rate of the Filterra media.

Further scenarios were developed for the Filterra system that included supplemental downstream retention. These supplemental storage volumes were sized based on a percentage of the runoff volume from the 85<sup>th</sup> percentile, 24-hour depth (0% (absent), 10%, 20%, 30%, 40%, 50%). For these scenarios, an additional storage unit was simulated and received the treated flow from the

---

<sup>3</sup> In practice, designers would select a standard Filterra size that meets or exceeds the required design flowrate, therefore many systems will tend to be oversized in practice; the approach used for this equivalency analysis is conservative in that it assumes exactly the minimum size is used.

upstream Filtterra storage unit. The profile of the Filtterra system is described in Table B.5. The downstream retention unit was modeled with an assumed depth of 2.1 feet, based on typical Contech ChamberMaxx system geometry, assuming 6 inches gravel above and below the ChamberMaxx units.

**Table B.5. Summary of profile for Filtterra systems**

Media Filtration Rate, in/hr	Gravel Underdrain <sup>1</sup> , ft	Effective Water Storage in Retention Sump (ft)	Media Depth, ft	Effective Water Storage in Media <sup>2</sup> , ft	Ponding Depth, ft	Total Effective Water Depth (ft)	Approximate Footprint Sizing for 0.3 in/hr scenario <sup>3</sup>
140	0.5	0.2	2	0.5	0.5	2.4	0.19%

1 Gravel layer based on typical Filtterra design; all of the gravel layer was assumed to drain freely to the underdrain

2 Media storage depth divided as 0.3 ft suction storage and 0.5 ft freely drained storage.

3 Expressed as BMP footprint as percent of tributary impervious area (varies by land use and sizing increment; for example purposes only).

## **APPENDIX C – DATASETS AND ANALYSIS METHODS FOR POLLUTANT TREATMENT EVALUATION**

### **Data Development and Analysis Framework**

BMP performance is considered to be a function of BMP type, BMP design parameters, influent water quality characteristics, and other factors. As part of this analysis, it was necessary to develop a statistical description of BMP performance that accounted for the difference between conventional biofiltration and Filtterra systems and also accounted for the influence of land use runoff quality (i.e., BMP influent quality) on the expected BMP performance. The data development and analysis framework used for this project included four steps:

- 1) Compile and review data from monitoring studies of conventional bioretention systems; then screen these studies to identify studies that are reasonably representative of conventional biofiltration designs that would meet the MS4 Permit requirements, particularly focusing on factors that would influence treated effluent quality.
- 2) Compile and review monitoring data from full-scale monitoring studies of Filtterra systems.
- 3) Apply a common statistical analysis framework to analyze the data from both datasets.
- 4) Determine representative land use runoff quality.
- 5) Based on results from step 3 and 4, estimate the effluent quality expected for conventional biofiltration and Filtterra systems for each pollutant for a range of land use types.

### **Compilation and Screening of Conventional Biofiltration Studies**

The International Stormwater BMP Database ([www.bmpdatabase.org](http://www.bmpdatabase.org)) includes storm event monitoring data from 28 peer-reviewed studies of bioretention BMPs with underdrains. These data were used as the primary source for characterizing the treatment performance of conventional biofiltration BMPs in this study. In addition to the 28 studies from the International BMP Database, four peer-reviewed research studies (Davis 2007; Li and Davis 2009; David et al., 2011; Gilbreath et al. 2012) not contained in the International BMP Database were added to the sample pool for analysis. Two of these studies were conducted recently in the San Francisco Bay area, which has biofiltration design standards and media specifications nearly identical to Attachment H of the Los Angeles MS4 Permit. The two other additional studies were included due to their similarity to Attachment H design criteria and rigor of their analytical methods.

### ***Screening Process for Developing Conventional Biofiltration Sample Pool***

To our knowledge, there have yet to be any BMPs monitored in Southern California that have been constructed to the specific criteria of Attachment H. Additionally, the two studies monitored in the San Francisco Bay area (designed to very similar standards as Attachment H)

(David et al., 2011; Gilbreath et al. 2012) provide a relatively small sample size and did not monitor for nutrients. Therefore, it was necessary to broaden the scope of studies to represent conventional biofiltration.

In general, the bioretention BMPs in the International BMP Database are considered to be representative of the range of designs that could meet the MS4 Permit Attachment H requirements. Most of the bioretention studies in the BMP Database were completed fairly recently (most in the last 10 years) and have typically been designed, constructed, and/or monitored under the supervision of experienced researchers. Many of these systems have been designed with BMP profiles (i.e., ponding depth, media depth), media filtration rates, and media composition that are similar to the criteria in Attachment H. However, where design attributes indicated that performance would be expected to be poorer than Attachment H designs and/or representativeness could not be evaluated, these studies were screened out of the analysis pool for this study. Systems that were expected to achieve similar or better performance than a typical BMP designed per Attachment H were kept in the pool; this is a conservative approach when evaluating Filtterra equivalency because it tends to establish a higher baseline for comparison than if these BMPs were excluded.

Screening criteria were developed based on professional judgment, as informed by review of literature and BMP performance studies. Our understanding of the influence of design parameters on bioretention performance was informed by studies in the BMP Database (see various summary reports at [www.bmpdatabase.org](http://www.bmpdatabase.org)), a recent evaluation by Roseen and Stone (2013), and review of recent bioretention media research in Washington State. A summary of the relevant findings are provided in the paragraphs below.

Roseen and Stone (2013) conducted an evaluation of biofiltration performance to determine how design criteria and media composition influence performance. As part of their research, they compiled site, design, and performance data for 80 field bioretention systems and 114 lab columns/mesocosms. Data from the International BMP Database were included in this pool as well as other research studies. Performance data were compiled as study summaries (e.g., study median influent, effluent, and removal efficiency). Roseen and Stone then utilized design information to categorizing systems into groups based on common combinations of factors. They then conducted a statistical evaluation of how performance was influenced by design factors such as presence/absence of mulch layers, use of compost in media, infiltration rate of media, ratio of tributary to biofiltration area, presence/absence of pretreatment, presence/absence of internal storage layers, etc. Roseen and Stone found that the presence of compost in mixes strongly influences the variability in performance and potential export of pollutants, including phosphorus, nitrogen, and copper. Systems without compost and/or with a high fraction of sand tended to provide the most consistent and best performance for these pollutants. Systems with an

internal water storage zone tended to perform better for nutrients than systems without an internal water storage zone. Finally, they found that media flowrate and depth of media bed tended to have an influence on performance. Beyond these findings, the influence of other parameters was less conclusive.

Recent bioretention studies, many in Washington State (Herrera 2014b, 2015a, 2015b), have identified the potential severity of pollutant export of nitrogen, phosphorus, and copper from conventional biofiltration systems and have evaluated the potential sources of these issues. For example, a full scale field monitoring study in the City of Redmond (WA) observed export of nitrate on the scale of 100 mg/L higher than influent quality and dissolved copper on the scale of 10 to 20 ug/L higher than influent. Follow up research has shown that compost is consistently associated with export of copper, nitrogen and phosphorus, even when the highest quality compost products available are used in designs and at proportions as low as 10% of the media blend by volume. This research also found that some sand products can also contain elevated levels of phosphorus and copper. These studies are relevant because the standard biofiltration media specifications for Western Washington are very similar to Attachment H, calling for 60 to 65 percent sand and 35 to 40 percent compost. It should also be noted that the compost certification criteria in Washington State (Washington Department of Ecology, 2014) allow for half as much metals content as allowed in the Attachment H specification, therefore should theoretically have less potential for export of metals than compost meeting the Attachment H specification.

Based on these literature findings and best professional judgment, the following criteria were applied as part of screening bioretention studies:

- Systems with media filtration rates substantially higher than 12 inches per hour were excluded – while higher rate media has been found to provide good performance in some cases, the general trends observed by Roseen and Stone (2013) indicated a decline in performance for some parameters with increased infiltration rates.
- Systems with sizing factors (BMP area as fraction of tributary area) substantially smaller than the 3 to 5 percent (20:1 to 30:1 ratio of tributary area to BMP area) were excluded – this parameter is related to media filtration rate and is an indicator of the degree of hydraulic loading.
- Systems that were observed to have very infrequent underdrain discharge (i.e., mostly infiltration) were excluded – for these designs, the effluent that was sampled for water quality was likely not representative of the entire storm event.
- Systems with internal water storage zones were kept in the pool of data; these systems are believed to provide better control of nutrients than systems without internal water storage; Attachment H does not require internal water storage to be provided.

- Based on the findings of Roseen and Stone (2013) as well as recent research in Washington State, mixes with less compost and a higher fraction of sand than the Attachment H specification were kept in the sample pool because they are believed to provide more reliable performance and less potential for export of pollutants on average than a 70-30 sand/compost mix.
- Systems that contained media with experimental components were excluded.
- Finally, systems were excluded if there was not enough design information reported to be able to evaluate representativeness, and/or any other factors were noted by the original study researchers that were believed to contribute to poorer performance than average. For example, some studies were noted as underperforming studies due to construction issues, premature clogging, etc.

Overall, the screening that was applied is believed to improve the representativeness of the sample pool and generally increase the average performance of the sample pool compared to the entire pool of studies contained in the International BMP Database. As discussed above, establishing a higher baseline level of performance for conventional biofiltration is conservative in the context of this evaluation.

### ***Screening Results***

Table C.2 summarizes the number of data points for each constituent after applying screening to remove unrepresentative studies and without screening.

**Table C.2. Summary of data points by parameter for conventional biofiltration BMPs**

<b>Constituent</b>	<b>Number of Screened Data Pairs</b>	<b>Number of Unscreened Data Pairs</b>
Total Suspended Solids	234	354
Total Phosphorus	242	384
Total Nitrogen	71	184
Total Copper	190	216
Total Zinc	200	252

### ***Inventory of Bioretention Studies and Screening Results/Rationales***

Table C.4 (located at the end of this Appendix) provides an inventory of studies of bioretention with underdrains from the International BMP Database, screening results, and brief rationales for screening.

**Compilation of Filtterra Studies**

Data were compiled from various field-scale Filtterra monitoring studies from 2004 through 2014. The design of the Filtterra system has not changed appreciably over time; therefore a screening step to determine representative studies was not necessary. The studies used in this analysis are summarized in Table 3 below. Full citations for these studies can be found in the references section.

**Table C.3. Inventory of studies and data points by parameter for Filtterra systems**

<b>Pollutant (total count of data pairs)</b>	<b>Data Pairs by Study</b>	<b>Reference</b>
Total Suspended Solids (n= 165)	11	TARP (2004-2005) : Yu and Stanford (2006)
	7	TARP Addendum (2006-2007): ATR Associates (2009)
	25	Perf. Over Time: Cal's Pizza (2008-2014): Americast (2009b; 2015)
	24	Perf. Over Time: Jiffy Lube (2008-2011): Americast (2009b; 2015)
	13	Perf. Over Time: Coliseum (2007-2014): Americast (2009b, 2015)
	29	NCDNR Fayetteville (2013-14): NCSU (2015a)
	22	TAPE Bellingham (2013): Herrera (2014a)
Total Phosphorus (n=146)	34	TAPE Port of Tacoma (2009): Herrera (2009)
	14	TARP (2004-2005) : Yu and Stanford (2006)
	6	TARP Addendum (2006-2007): ATR Associates (2009)
	71	Perf. Over Time: Cal's Pizza (2008-2014): Americast (2009b; 2015)
	33	NCDNR Fayetteville (2013-14): NCSU (2015a)
Total Nitrogen (n = 34)	22	TAPE Bellingham (2013): Herrera (2014a)
Total Copper (n = 112)	34	NCDNR Fayetteville (2013-14): NCSU (2015a)
	8	TARP (2004-2005): Yu and Stanford (2006)
	24	Perf. Over Time: Jiffy Lube (2008-2011): Americast (2009b; 2015)
	21	Perf. Over Time: Coliseum (2007-2014): Americast (2009b, 2015)
	13	NCDNR Fayetteville (2013-14): NCSU (2015a)
	29	TAPE Port of Tacoma (2009): Herrera (2009)
Total Copper (n = 112)	17	TAPE Bellingham (2013): Herrera (2014a)



Pollutant (total count of data pairs)	Data Pairs by Study	Reference
Total Zinc (n = 120)	16	TARP (2004-2005): Yu and Stanford (2006)
	24	Perf. Over Time: Jiffy Lube (2008-2011): Americast (2009b; 2015)
	21	Perf. Over Time: Coliseum (2007-2014): Americast (2009b, 2015)
	13	NCDNR Fayetteville (2013-14): NCSU (2015a)
	29	TAPE Port of Tacoma (2009): Herrera (2009)
	17	TAPE Bellingham (2013): Herrera (2014a)

Key to acronyms:

TARP: Technology Acceptance Reciprocity Partnership  
 TAPE: Technology Acceptance Protocol-Ecology (Washington State)  
 NCDNR: North Carolina Department of Natural Resources  
 NCSU: North Carolina State University

**Data Analysis Method**

The most common ways to characterize BMP performance include (1) removal efficiency (percent removal) in various forms, and (2) effluent probability. In general, the effluent probability approach is recommended for evaluating BMP performance and applying BMP performance to pollutant load models (Geosyntec and Wright Water, 2009). This method involves conducting a statistical comparison of influent and effluent quality to determine if effluent is significantly different from influent. If effluent is significantly different from influent, then the effluent quality is characterized by a statistical distribution developed from all effluent data points. Probability plots are prepared indicating the probability that a certain effluent quality is achieved.

However, to isolate differences in performance between two BMP types, the effluent probability method requires the assumption that the influent quality was similar between the studies of the two BMP types being compared. This assumption is generally reliable for categorical analysis of BMPs in the International BMP Database because of the large number of studies in the most categories in the Database. However, when comparing BMP types with a relatively limited number of study sites (such as the Filtterra dataset), this assumption may not be reliable.

To address these challenges and help ensure a valid comparison between conventional biofiltration and Filtterra systems, a moving bootstrap method (Leisenring et al., 2009) was applied to both datasets. This method characterizes influent-effluent relationships such that the BMPs compared do not need to have been studied under conditions with similar influent quality. In this approach, all data pairs are used to form the total sample population. Then for each increment of influent quality, a subsample of the overall population is formed including only those data pairs that lie within a certain span of the selected influent quality. Applying bootstrap

principles (Singh and Xie, 2008), the median and the confidence interval around the median is computed as well the mean and the confidence interval around the mean. Then a new increment of influent quality is selected and the process is repeated with a new subsample population until a statistical description of effluent quality has been developed for each increment of influent quality over the range of the data. Rules are also imposed regarding selection the initial span of the moving window and expansion the span of the window, if needed, to ensure monotonicity (i.e., ensure that effluent quality always increases or stays the same with increasing influent quality).

Resulting tables and plots from this analysis are presented in Appendix D.

### **Land Use Stormwater Quality Inputs and Assumptions**

Representative stormwater runoff concentrations for the land use condition used in this analysis were developed based on the land use stormwater quality monitoring data reported in the Los Angeles County 1994-2000 Integrated Receiving Water Impacts Report, 2000 and Los Angeles County 2000-2001 Stormwater Monitoring Report, 2001(LA County 2000; LA County 2001). The median and mean runoff quality values from this dataset were used as representative influent water quality conditions for the purpose of evaluating BMP performance. These concentrations represent only one land use monitoring station in one geographic area; actual conditions for a given drainage area in a given region are anticipated to vary. Beyond the range of water quality presented in this table, this analysis did not attempt to characterize the uncertainty/variability in runoff water quality. This simplification is considered appropriate for evaluating equivalency in BMP performance.

Land use runoff quality is reported in Appendix D.

**Table C.4. Inventory of conventional biofiltration studies from the International BMP Database and screening rationale**

Source	Site Name	Sponsoring Entity	State	City	Selected?	Selection/Rejection Reasons
Int. BMP Database	Rocky Mount Grassed Bioretention Cell 1	North Carolina State	NC	Rocky Mount	Yes	Aligns with Att. H; Has internal water storage zone and underdrain
Int. BMP Database	Rocky Mount Mulch/Shrub Bioretention Cell 1	North Carolina State	NC	Rocky Mount	Yes	Aligns with Att. H; Has internal water storage zone and underdrain
Int. BMP Database	CHS_BioFilter	The Thomas Jefferson Planning District Commission	VA	Charlottesville	Yes	Aligns with Att. H; Has internal water storage zone, underdrain, and mulch layer (0.25 feet)
Int. BMP Database	Parks & Forestry Bioretention	City of Overland Park	KS	Overland Park	Yes	Aligns with Att. H; Has internal water storage zone, underdrain, and mulch layer
Int. BMP Database	Bioretention 6	Johnson County	KS	Shawnee	Yes	Aligns with Att. H; Has internal water storage zone and underdrain
Int. BMP Database	G2	North Carolina State	NC	Greensboro	Yes	Aligns with Att. H; Has underdrain, and mulch layer (7-10 cm)
Int. BMP Database	G1	North Carolina State	NC	Greensboro	Yes	Aligns with Att. H; Has underdrain, and mulch layer (7-10 cm)
Int. BMP Database	L1	North Carolina State	NC	Louisburg	Yes	Aligns with Att. H; Appropriate loading ratio
Int. BMP Database	Bioretention 3B	Johnson County	KS	Shawnee	Yes	Aligns with Att. H; Has internal water storage zone and underdrain
Int. BMP Database	Parking Lot Bioretention Cell	City of Fort Collins	CO	Fort Collins	Yes	Aligns with Att. H; Has internal water storage zone and mulch layer

Filterra Equivalency Analysis  
August 2015

Source	Site Name	Sponsoring Entity	State	City	Selected?	Selection/Rejection Reasons
<b>Int. BMP Database</b>	Bioretention Cells	Johnson County SMP	KS	Overland Park	Yes	Aligns with Att. H; Has internal water storage zone, underdrain, and mulch layer
<b>Int. BMP Database</b>	Bioretention Cell	Johnson County SMP	KS	Overland Park	Yes	Aligns with Att. H; Has internal water storage zone and underdrain
<b>Int. BMP Database</b>	Bioretention System (D1)	UNH/Cooperative Institute for Coastal and Estuarine Environmental Technology	NH	Durham	Yes	Aligns with Att. H; Has pretreatment, internal water storage zone, underdrain, and mulch layer
<b>Int. BMP Database</b>	UDFCD Rain Garden	Urban Drainage and Flood Control District	CO	Lakewood	Yes	Aligns with Att. H; Has internal water storage zone, underdrain, and compost layer
<b>Int. BMP Database</b>	Hal Marshall Bioretention Cell	City of Charlotte, North Carolina	NC	Charlotte	Yes	Aligns with Att. H; Has underdrain, and mulch layer
<b>Int. BMP Database</b>	Rocky Mount Grassed Bioretention Cell 2	The Cooperative Institute for Coastal and Estuarine Environmental Technology	NC	Rocky Mountain	Yes	Aligns with Att. H; Has internal water storage zone and underdrain
<b>Li and Davis (2009)</b>	Bioretention Cell 1	Prince George's County Department of Environmental Resources/ U of MD	MD	College Park	Yes	Aligns with Att. H
<b>Li and Davis (2009)</b>	Bioretention Cell 2	Prince George's County Department of Environmental Resources/U of MD	MD	Silver Spring	Yes	Aligns with Att. H
<b>Davis (2007)</b>	Bioretention Cell 1	Prince George's County Department of Environmental Resources/U of MD	MD	College Park	Yes	Aligns with Att. H
<b>David et al. (2011)</b>	Daly City Library Rain Gardens	San Francisco Estuary Institute	CA	Daly City	Yes	Aligns with Att. H
<b>Gilbreath et al. (2012)</b>	San Pablo Ave Green Streets	San Francisco Estuary Institute	CA	El Cerrito	Yes	Aligns with Att. H
<b>Int. BMP Database</b>	Bioretention Area	Virginia Department of Conservation and Recreation	VA	Charlottesville	No	Not enough design info provided
<b>Int. BMP Database</b>	Small Cell	North Carolina Department of Transportation	NC	Knightdale	No	Infiltration rate low; noted to be underperforming BMP by

Filterra Equivalency Analysis  
August 2015

Source	Site Name	Sponsoring Entity	State	City	Selected?	Selection/Rejection Reasons
						study researchers
<b>Int. BMP Database</b>	BRC_B	North Carolina State	NC	Nashville	No	Infiltration too low and undersized
<b>Int. BMP Database</b>	North cell	North Carolina State	NC	Raleigh	No	Media very different from Att. H
<b>Int. BMP Database</b>	WA Ecology Embankment at SR 167 MP 16.4	Washington State Dept. of Transportation	WA	Olympia	No	Linear design; lateral flow; not representative of typical biofiltration design
<b>Int. BMP Database</b>	Bioretention Cell	Delaware Department of Transportation	DE	Dover	No	Design is very different from Att. H
<b>Int. BMP Database</b>	East 44th St. Pond	City of Tacoma	WA	Tacoma	No	No design data
<b>Int. BMP Database</b>	Tree Filter	UNH/Cooperative Institute for Coastal and Estuarine Environmental Technology	NH	Durham	No	Design is very different from Att. H
<b>Int. BMP Database</b>	BRC_A	North Carolina State University	NC	Raleigh	No	Infiltration rate very low; noted to be a partially clogged/failing system
<b>Int. BMP Database</b>	Cub_Run_Bioreten tion	Fairfax County	VA	Fairfax	No	No design data provided
<b>Int. BMP Database</b>	South cell	North Carolina State University (BAE)	NC	Raleigh	No	Design is very different from Att. H
<b>Int. BMP Database</b>	R Street	City of Tacoma	WA	Tacoma	No	No design data provided

## **APPENDIX D – RESULTS OF POLLUTANT TREATMENT DATA ANALYSIS**

The data analysis methods described in Appendix C were applied to the datasets described in Appendix C. The following pages present tabular and graphical results of this analysis.

**Table D.1. Summary Statistics - Bioretention Studies and Filterra Studies**

*Median Statistics*

Land Use	Pollutant	Units	Median Representative Runoff Quality	Conventional Biofiltration Effluent (Screened)		Conventional Biofiltration Effluent (Unscreened)		Filtrerra Effluent	
				Median	95th percentile UCL on Median	Median	95th percentile UCL on Median	Median	95th percentile UCL on Median
Commercial	TSS	mg/L	53	12	13.7	11	12	4.9	5
	Total Phosphorus	mg/L	0.27	<b>0.46</b>	<b>0.55</b>	0.26	<b>0.37</b>	0.06	0.08
	Total Nitrogen	mg/L	2.3	1.6	<b>2.9</b>	1.19	1.52	1	1.6
	Copper	ug/L	22	12	15	12	14	10	10
	Zinc	ug/L	192	35	44	36	40	70	77
High Density Single Family Residential	TSS	mg/L	61	12	15	12	13	5.0	5.0
	Total Phosphorus	mg/L	0.32	<b>0.47</b>	<b>0.55</b>	0.28	<b>0.43</b>	0.09	0.11
	Total Nitrogen	mg/L	2	1.6	<b>2.9</b>	1.2	1.5	1	1.6
	Copper	ug/L	11	5.3	5.9	5.3	6.4	5.5	6.0
	Zinc	ug/L	66	20	27	18	26	31	35
Light Industrial	TSS	mg/L	129	16	18	16	18	5.2	7.0
	Total Phosphorus	mg/L	0.3	<b>0.47</b>	<b>0.55</b>	0.27	<b>0.42</b>	0.09	0.11
	Total Nitrogen	mg/L	2.4	1.6	<b>2.9</b>	1.2	1.5	1.3	1.6
	Copper	ug/L	21	12	15	12	13.85	10	10
	Zinc	ug/L	366	35	44	36	40	80	95
Multi-family Residential	TSS	mg/L	24	10.8	12.5	9.9	9.9	3	3
	Total Phosphorus	mg/L	0.14	<b>0.39</b>	<b>0.45</b>	<b>0.21</b>	<b>0.25</b>	0.04	0.05
	Total Nitrogen	mg/L	1.5	<b>1.6</b>	<b>2.9</b>	1.2	<b>1.5</b>	0.9	1
	Copper	ug/L	12	5.6	6.1	5.6	6.6	5.5	6.0
	Zinc	ug/L	89	20	27	18	26	35	37

*Mean Statistics*

Land Use	Pollutant	Units	Mean Representative Runoff Quality	Conventional Biofiltration Effluent (Screened)		Conventional Biofiltration Effluent (Unscreened)		Filtrerra Effluent	
				Mean	95th percentile UCL on Mean	Mean	95th percentile UCL on Mean	Mean	95th percentile UCL on Mean
Commercial	TSS	mg/L	66	28	49	25	39	6.0	7.9
	Total Phosphorus	mg/L	0.39	<b>0.80</b>	<b>1.3</b>	<b>0.65</b>	<b>1.0</b>	0.11	0.14
	Total Nitrogen	mg/L	3.6	2.9	<b>4.3</b>	2.1	2.8	NA	NA
	Copper	ug/L	39	19	29	16	24	18	29
	Zinc	ug/L	241	65	145	59	108	69	105
High Density Single Family Residential	TSS	mg/L	95	28	49	25	39	6.0	8.5
	Total Phosphorus	mg/L	0.39	<b>0.80</b>	<b>1.3</b>	<b>0.65</b>	<b>1.0</b>	0.11	0.14
	Total Nitrogen	mg/L	3.0	2.9	<b>4.3</b>	2.1	2.8	NA	NA
	Copper	ug/L	15	13	<b>21</b>	13	19	12	<b>19</b>
	Zinc	ug/L	79	33	50	32	46	28	45
Light Industrial	TSS	mg/L	240	46	105	40	87	16	31
	Total Phosphorus	mg/L	0.41	<b>0.80</b>	<b>1.3</b>	<b>0.65</b>	<b>1.0</b>	0.11	0.14
	Total Nitrogen	mg/L	3.1	2.9	<b>4.3</b>	2.1	2.8	NA	NA
	Copper	ug/L	32	19	29	16	24	18	29
	Zinc	ug/L	639	NA	NA	59	108	168	285
Multi-family Residential	TSS	mg/L	46	18	28	18	27	6.0	7.9
	Total Phosphorus	mg/L	0.2	<b>0.8</b>	<b>1.3</b>	<b>0.6</b>	<b>1.0</b>	0.06	0.07
	Total Nitrogen	mg/L	2.1	<b>2.9</b>	<b>4.3</b>	<b>2.1</b>	<b>2.8</b>	1.1	1.5
	Copper	ug/L	12	10	15	9	14	9	<b>15</b>
	Zinc	ug/L	146	45	90	32	46	38	60

NA - Average values could not be computed for because the land use average influent is outside of the range of influent observed in monitoring studies.

**Key to cell formatting**

**Red bold** indicates median or mean effluent concentration higher than influent concentration. This is indicative of the potential for pollutant export.

**Blue** indicates upper confidence interval of effluent concentration is higher than the influent concentration. This is not a conclusive indicator, but is provided for reference.

Figure D.1 Moving Window Plots of Medians

Screened Biofiltration Dataset

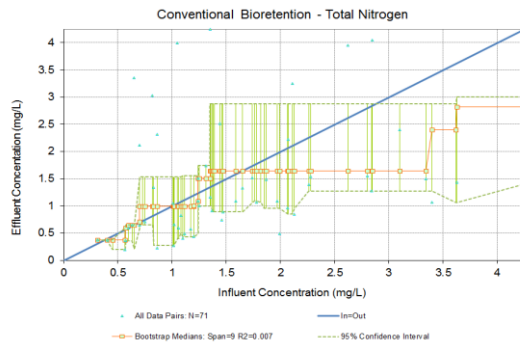
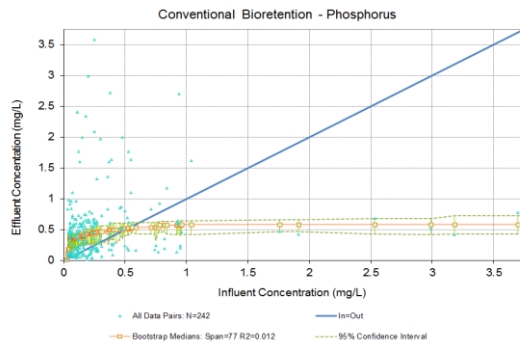
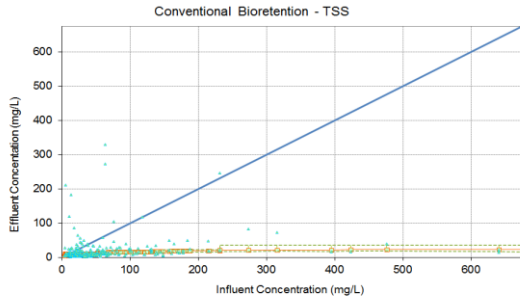

Unscreened Biofiltration Dataset

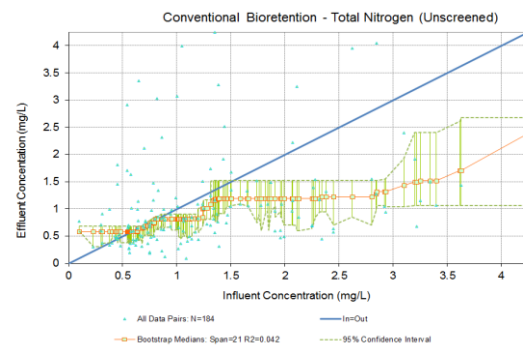
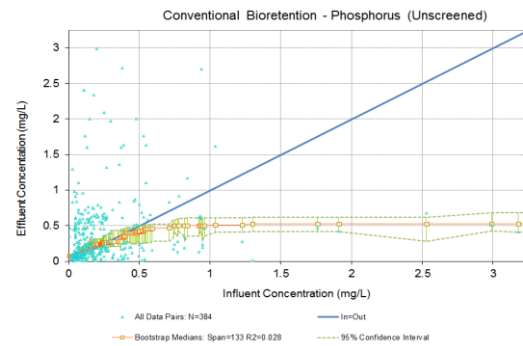
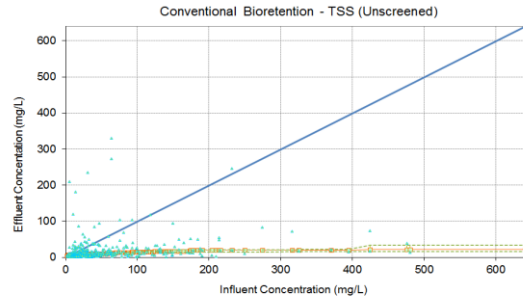

Filterra Dataset

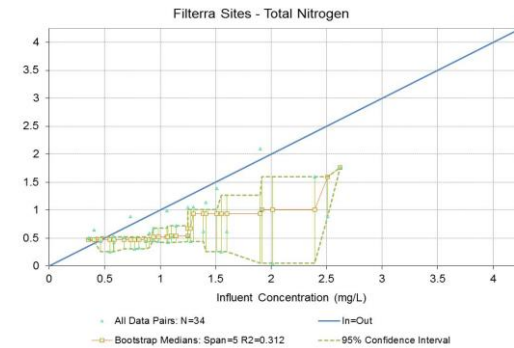
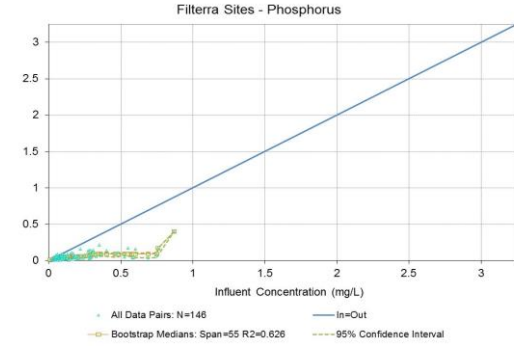
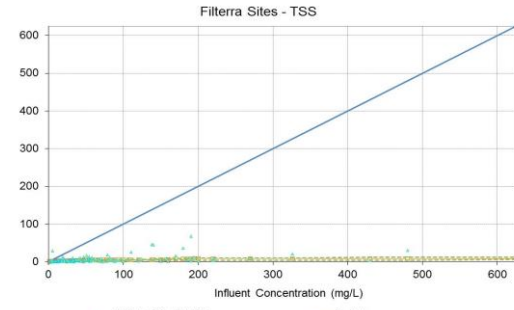
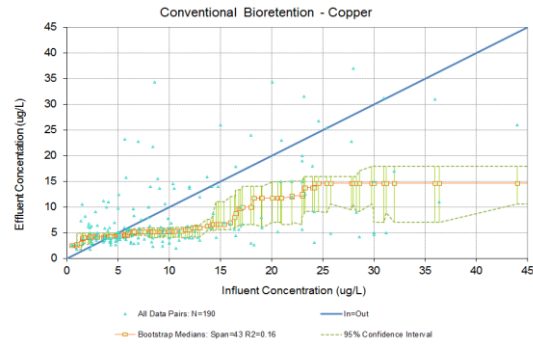

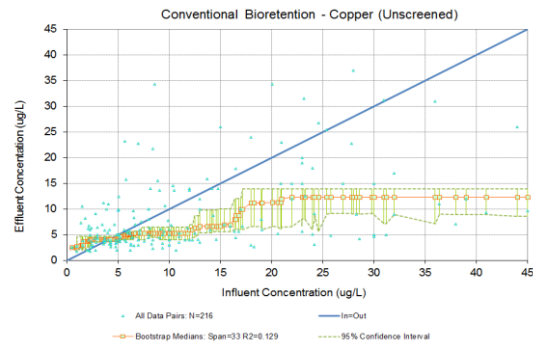

Figure D.1 Moving Window Plots of Medians

Screened Biofiltration Dataset



Unscreened Biofiltration Dataset



Filtterra Dataset

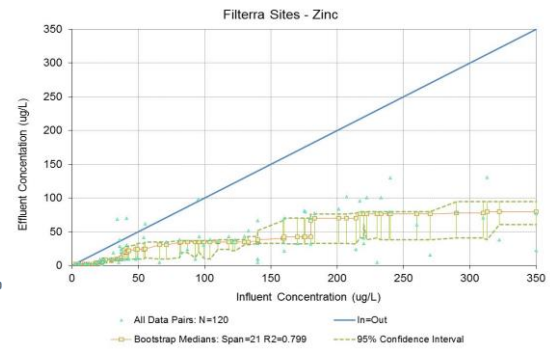
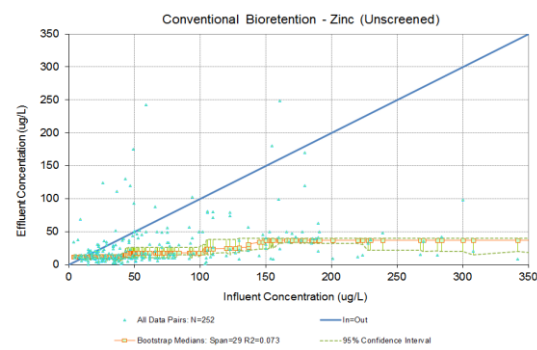
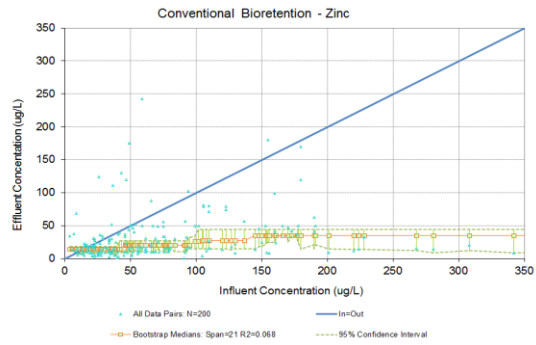
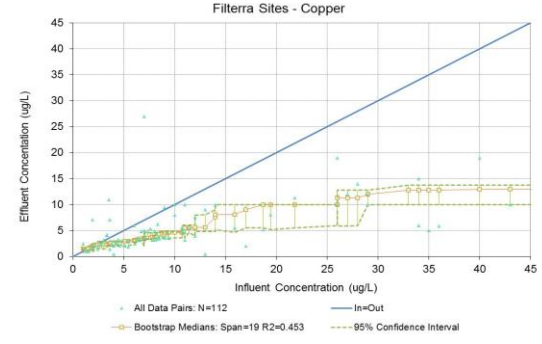

Figure D.2 Moving Window Plots of Means

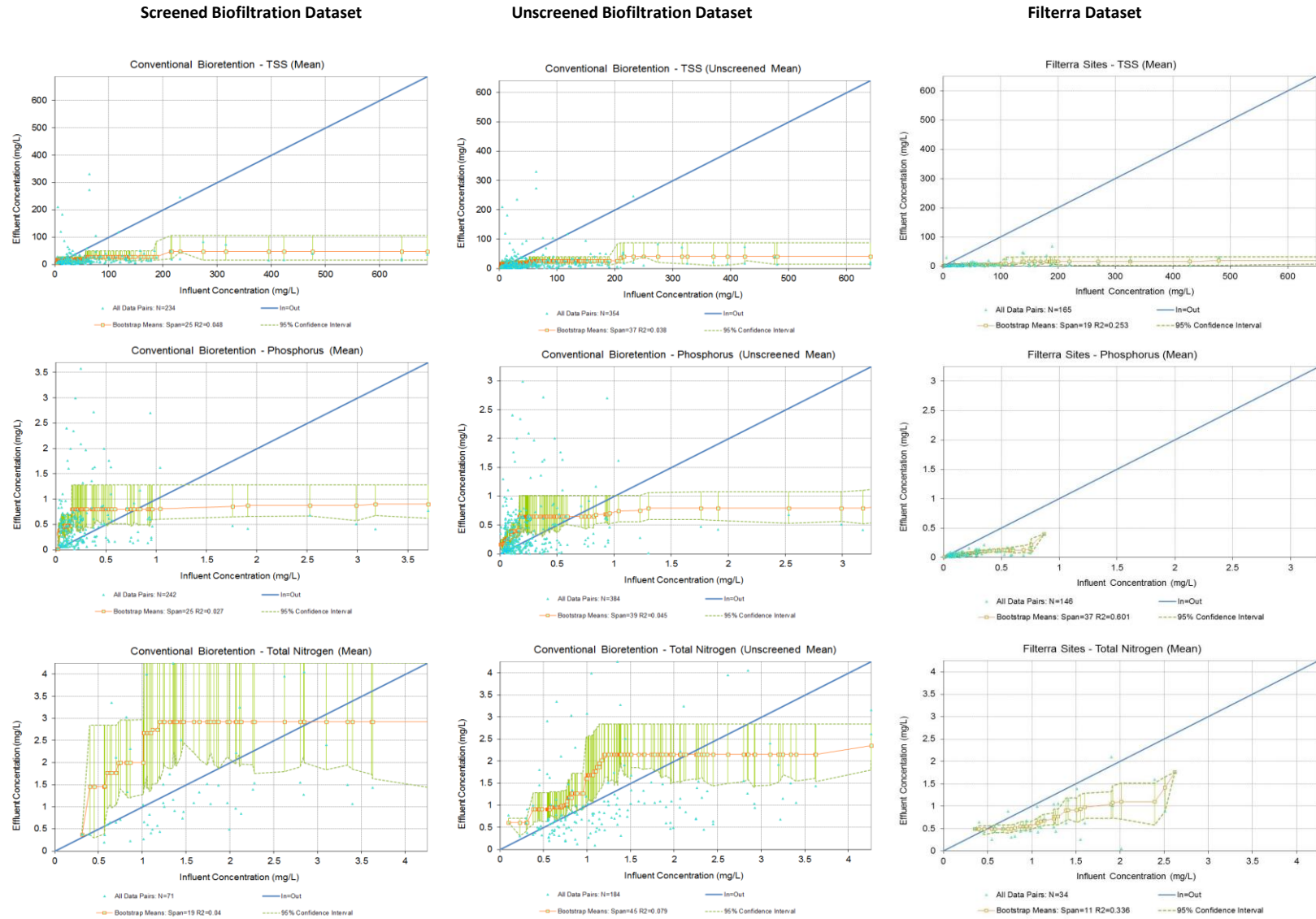
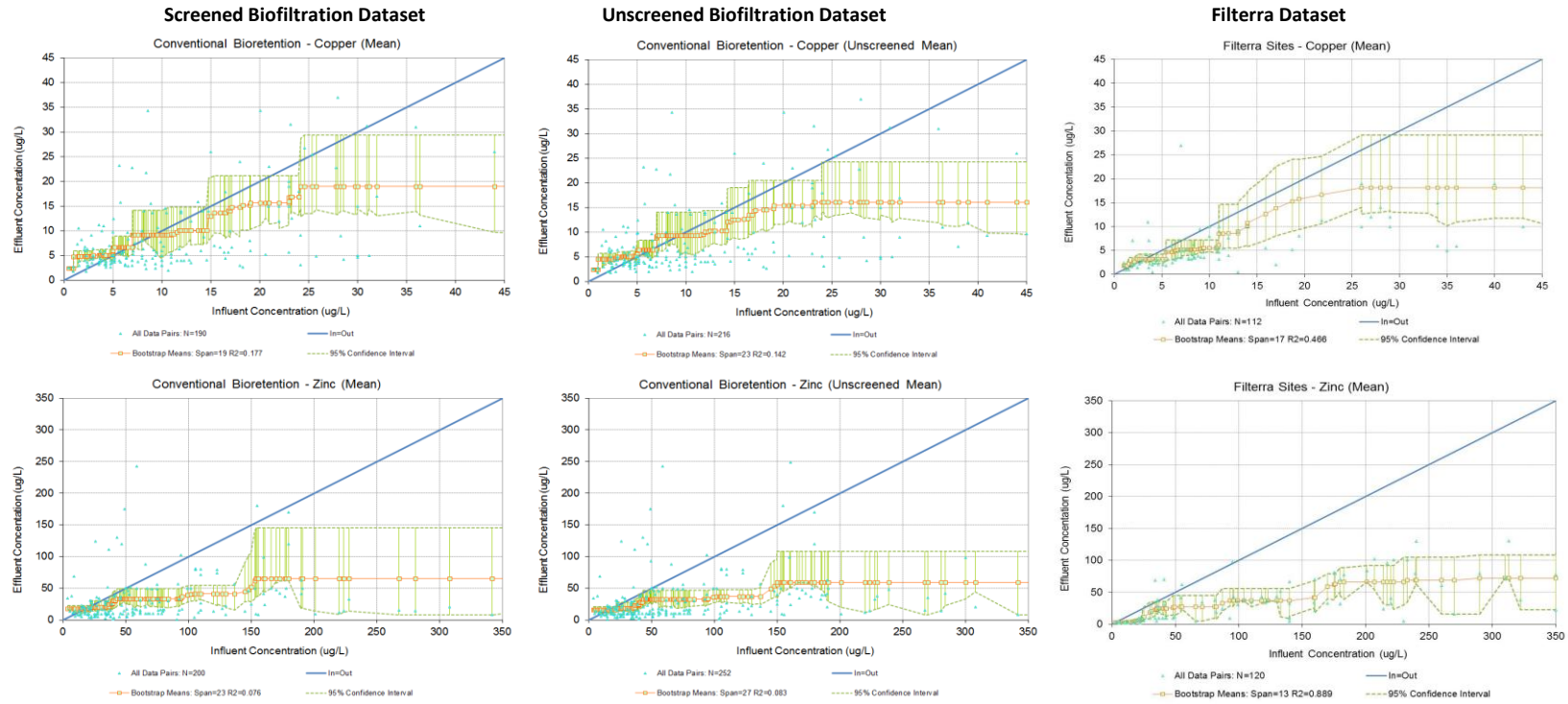
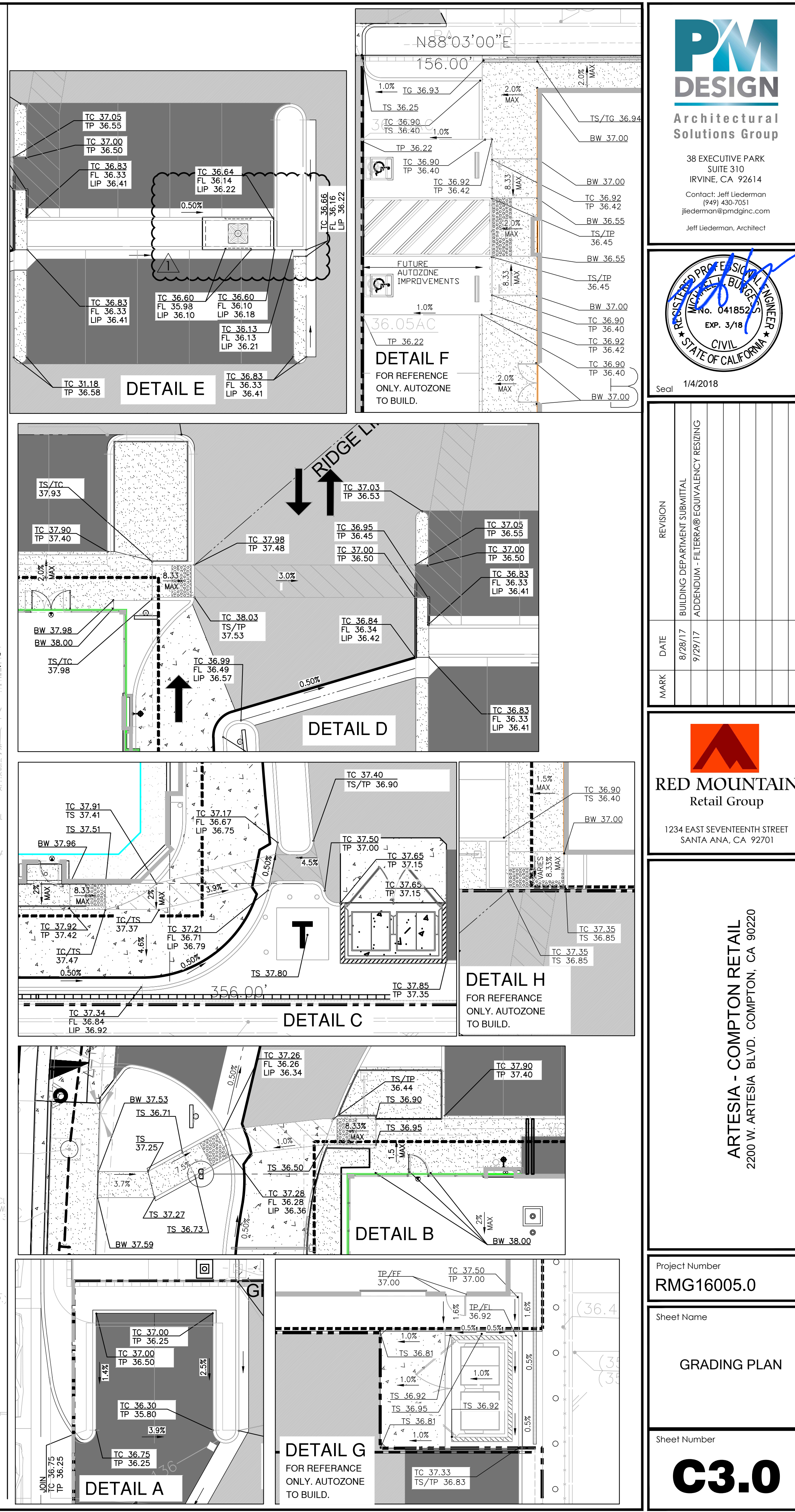
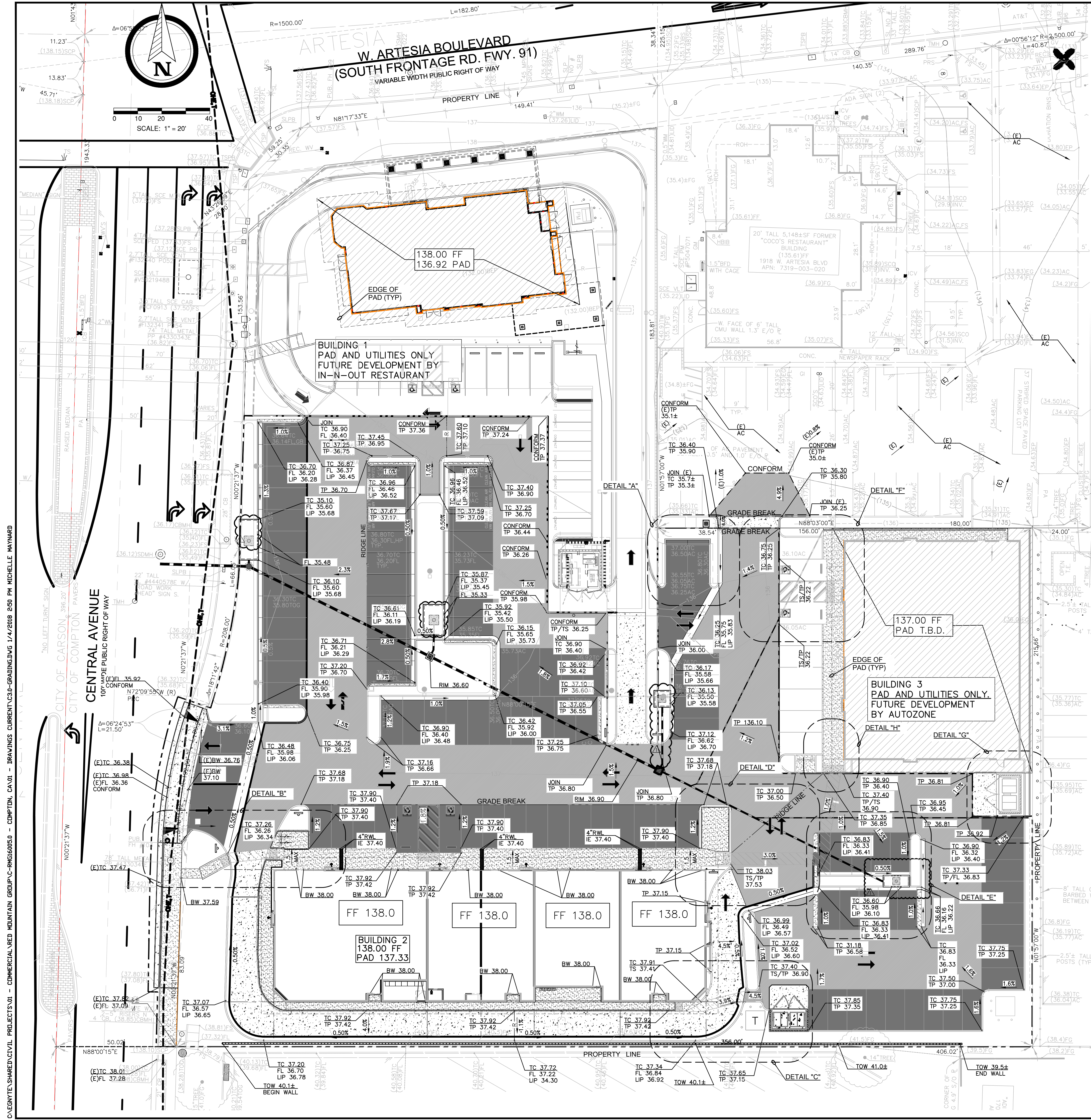

Figure D.2 Moving Window Plots of Means





**PM DESIGN**  
Architectural Solutions Group

38 EXECUTIVE PARK  
SUITE 310  
IRVINE, CA 92614

Contact: Jeff Uiedeman  
(949) 430-7051  
juedeman@pmdginc.com  
Jeff Uiedeman, Architect

REGISTERED PROFESSIONAL ENGINEER  
IN THE STATE OF CALIFORNIA  
No. 041852  
CIVIL  
EXP. 3/18

Seal 1/4/2018

REVISION	DATE	MARK	DESCRIPTION
1	9/29/17		BUILDING DEPARTMENT SUBMITTAL
2	9/29/17		ADDENDUM - FILTERBAR EQUIVALENCY RESIZING

**RED MOUNTAIN**  
Retail Group

1234 EAST SEVENTEENTH STREET  
SANTA ANA, CA 92701

ARTESIA - COMPTON RETAIL  
2200 W. ARTESIA BLVD. COMPTON, CA 90020

Project Number  
**RMG16005.0**

Sheet Name  
**GRADING PLAN**

Sheet Number  
**C3.0**

C:\EGNTE\SHARE\CIVIL\PROJECTS\01 - COMMERCIAL\RED MOUNTAIN GROUP\C-BMP.DWG 1/4/2018 9:50 PM MICHELLE MAYNARD

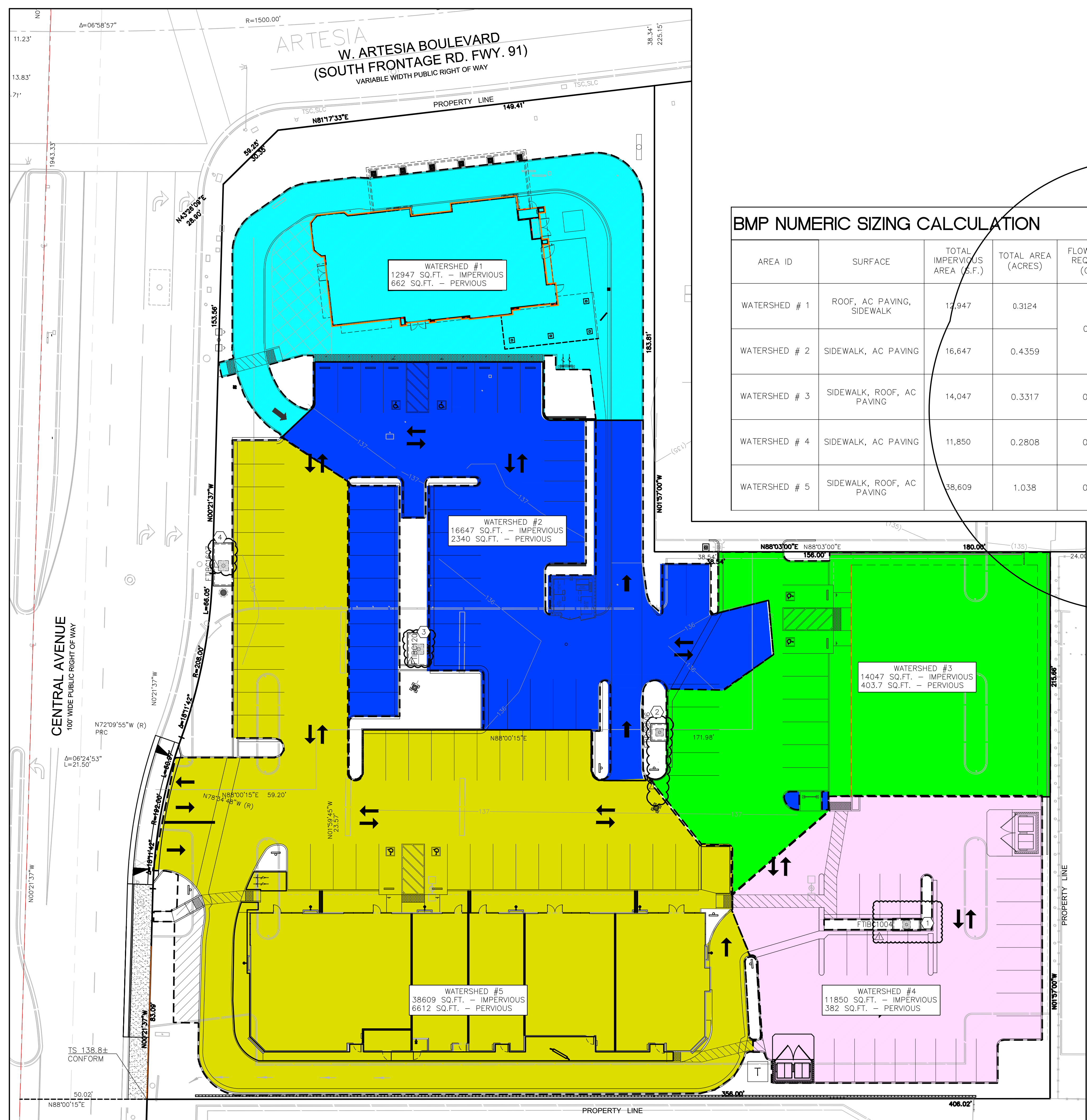

BMP LEGEND	
	WATERSHED BOUNDARY
	IMPERVIOUS AREA (COLOR PER WATERSHED)
	LANDSCAPED AREA
	FILTERRA®
	CONVEYANCE LINE

### BMP NUMERIC SIZING CALCULATION

AREA ID	SURFACE	TOTAL IMPERVIOUS AREA (S.F.)	TOTAL AREA (ACRES)	FLOW RATE REQUIRED (CFS)	1.5 x STORMWATER QUALITY DESIGN VOLUME	BMP TO BE USED	BMP VAULT SIZE (FT X FT)	DESIGN FLOW RATE FOR EQUIVALENCY (CFS)	FILTERRA® UNIT REQUIRED ARE FOR EQUIVALENCY (S.F.)
WATERSHED # 1	ROOF, AC PAVING, SIDEWALK	12,947	0.3124	0.18	2,895	FILTERRA®	12 X 8	0.26	79
WATERSHED # 2	SIDEWALK, AC PAVING	16,647	0.4359						
WATERSHED # 3	SIDEWALK, ROOF, AC PAVING	14,047	0.3317	0.08	1,245	FILTERRA®	6 X 6	0.11	35
WATERSHED # 4	SIDEWALK, AC PAVING	11,850	0.2808	0.08	1150.5	FILTERRA®	10 X 4	0.12	36
WATERSHED # 5	SIDEWALK, ROOF, AC PAVING	38,609	1.038	0.23	3,807	FILTERRA®	16 X 7	0.32	101

### KEYNOTES

ITEM	DESCRIPTION
①	FILTERRA® INTERNAL BYPASS CURB - 10' X 4'; REFER TO SHEET 8.1
②	FILTERRA® INTERNAL BYPASS CURB - 6' X 6'; REFER TO SHEET 8.1
③	FILTERRA® INTERNAL BYPASS CURB - 12' X 8'; REFER TO SHEET 8.1
④	FILTERRA® INTERNAL BYPASS CURB - 16' X 7'; REFER TO SHEET 8.1

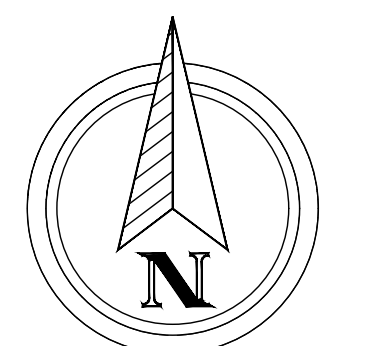
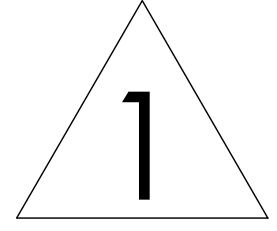

SCALE: 1" = 20'

**PM DESIGN**  
Architectural Solutions Group  
38 EXECUTIVE PARK SUITE 310 IRVINE, CA 92614  
Contact: Jeff Liederman (949) 430-7051  
jliederman@pmdginc.com  
Jeff Liederman, Architect

REGISTERED PROFESSIONAL ENGINEER  
NO. 041852  
EXP. 3/18  
CIVIL  
STATE OF CALIFORNIA

MARK	DATE	REVISION
	8/28/17	BUILDING DEPARTMENT SUBMITTAL
	9/29/17	ADDENDUM - FILTERRA® EQUIVALENCY RESIZING

**RED MOUNTAIN**  
Retail Group  
1234 EAST SEVENTEENTH STREET  
SANTA ANA, CA 92701

ARTESIA - COMPTON RETAIL  
2200 W. ARTESIA BLVD. COMPTON, CA 90220

Project Number  
**RMG16005.0**

Sheet Name  
**BMP PLAN**

Sheet Number  
**C7.0**



### Filterra Sizing Tool

Applicable in the Area Governed by the Los Angeles County MS4 Permit  
(NPDES PERMIT NO. CAS004001; ORDER NO. R4-2012-0175)

**For final design please contact:**  
**Maryjane Mac Leod - Stormwater Consultant**  
[mmacleod@conteches.com](mailto:mmacleod@conteches.com)  
**Phone: 818-519-1781**

<u>Contact Information</u>	<u>Project Information</u>
Engineer of Record Name	Project Name
Engineer of Record Company Name	Project Location
Engineer of Record Office Zip Code	Catchment Name

Michael Burgess
PM Design Group, Inc.
95404

Artesia - Compton Retail
Compton, CA
Watersheds 1 & 2

<u>Drainage Area Inputs</u>		
Drainage Area	32596	ft <sup>4</sup>
Runoff coefficient	0.8263	-
Time of concentration	20	min
Long term reliable infiltration rate	0.09	in/hr
85th percentile, 24-hour depth (see hyperlink below)	0.86	in

[LA County Rainfall Depth Analysis](#)

<u>Filterra Configuration (Select from Drop-Down)</u>	<u>Internal Bypass Curb - Chamber</u>
Refer to "Filterra Configurations" tab for descriptions and standard details for download.	

<u>Constants</u>		
LAX Airport 85th Percentile, 24-hour depth (for reference only)	1.02	in
Filterra hydraulic loading capacity	1.45	gpm/ft <sup>2</sup>
<b>Outputs</b>		
Stormwater Quality Design Volume	1,930	ft <sup>3</sup>
Design Rainfall Intensity for Equivalent Long Term Capture	0.341	in/hr
Site Scaling Factor	0.84	-
Stormwater Quality Design Flow Rate	0.18	cfs
Design Alternatives Available	<b>Stand Alone Filterra Permitted</b>	

<u>Design Recommendations</u>		
<i>Primary Recommendation - Stand Alone Filterra</i>		
Adjusted Filterra Design Intensity	0.486	in/hr
Stormwater Quality Design Flow Rate	0.26	cfs
Required Filterra Area	79	ft <sup>2</sup>
Filterra Model ID	<b>FTIBC-C 8x12 / 12x8</b>	
<i>Alternative Recommendation - Filterra + Infiltration Storage</i>		
Required Filterra Area	56	ft <sup>2</sup>
Filterra Model ID	<b>FTIBC-C 6x10 / 10x6</b>	
ChamberMaxx volume	259	ft <sup>3</sup>
ChamberMaxx count	4	chambers

To be consistent with approval of the Filterra Bioretention System as an alternative biofiltration specification granted by the Los Angeles Regional Water Quality Control Board on October 9, 2017, Filterra use is subject to the following conditions:

- Filterra systems must be designed and sized following the methodology in Section 4 of the August 2015 report prepared by Geosyntec Consultants, entitled "Filterra Equivalency Analysis and Design Criteria" which is the basis for this design tool.
- Filterra systems use an engineered biofiltration media. Filterra systems, including the engineered biofiltration media, must be provided by the manufacturer. No substitution of materials/media is allowed.
- Filterra is only applicable as an alternative on-site biofiltration design in situations where a project applicant has demonstrated that it is technically infeasible to retain 100 percent of the SWQDv on-site.
- Hydromodification requirements of Section VI.D.7.c.iv of the Los Angeles County MS4 Permit must be considered separately regardless of what type of biofiltration is used.
- Operation and maintenance of Filterra systems must be conducted consistent with the recommendations in the Filterra maintenance manual provided by Contech Engineered Solutions.
- In the area governed by the Los Angeles Region Phase I stormwater permit, conventional biofilters must be sized to treat 1.5X the SWQDv. This results in an average annual capture rate of 93%. Filterra systems sized using this tool will also treat at least 93% of the average annual runoff volume.



### Filterra Sizing Tool

Applicable in the Area Governed by the Los Angeles County MS4 Permit  
(NPDES PERMIT NO. CAS004001; ORDER NO. R4-2012-0175)

**For final design please contact:**  
**Maryjane Mac Leod - Stormwater Consultant**  
[mmacleod@conteches.com](mailto:mmacleod@conteches.com)  
**Phone: 818-519-1781**

Contact Information		Project Information	
Engineer of Record Name	Michael Burgess	Project Name	Artesia - Compton Retail
Engineer of Record Company Name	PM Design Group, Inc.	Project Location	Compton, CA
Engineer of Record Office Zip Code	95404	Catchment Name	Watershed 3

Drainage Area Inputs		
Drainage Area	14449	ft <sup>2</sup>
Runoff coefficient	0.8014	-
Time of concentration	17	min
Long term reliable infiltration rate	0.09	in/hr
85th percentile, 24-hour depth (see hyperlink below)	0.86	in

**Filterra Configuration (Select from Drop-Down)**      **Internal Bypass Curb - Chamber**  
Refer to "Filterra Configurations" tab for descriptions and standard details for download.

Constants		
LAX Airport 85th Percentile, 24-hour depth (for reference only)	1.02	in
Filterra hydraulic loading capacity	1.45	gpm/ft <sup>2</sup>

Outputs		
Stormwater Quality Design Volume	830	ft <sup>3</sup>
Design Rainfall Intensity for Equivalent Long Term Capture	0.351	in/hr
Site Scaling Factor	0.84	-
Stormwater Quality Design Flow Rate	0.08	cfs
Design Alternatives Available	<b>Stand Alone Filterra Permitted</b>	

Design Recommendations		
<i>Primary Recommendation - Stand Alone Filterra</i>		
Adjusted Filterra Design Intensity	0.503	in/hr
Stormwater Quality Design Flow Rate	0.11	cfs
Required Filterra Area	35	ft <sup>2</sup>
Filterra Model ID	<b>FTIBC-C 6x6</b>	

<i>Alternative Recommendation - Filterra + Infiltration Storage</i>		
Required Filterra Area	25	ft <sup>2</sup>
Filterra Model ID	<b>FTIBC-C 6x6</b>	
ChamberMaxx volume	111	ft <sup>3</sup>
ChamberMaxx count	2	chambers

To be consistent with approval of the Filterra Bioretention System as an alternative biofiltration specification granted by the Los Angeles Regional Water Quality Control Board on October 9, 2017, Filterra use is subject to the following conditions:

- Filterra systems must be designed and sized following the methodology in Section 4 of the August 2015 report prepared by Geosyntec Consultants, entitled "Filterra Equivalency Analysis and Design Criteria" which is the basis for this design tool.
- Filterra systems use an engineered biofiltration media. Filterra systems, including the engineered biofiltration media, must be provided by the manufacturer. No substitution of materials/media is allowed.
- Filterra is only applicable as an alternative on-site biofiltration design in situations where a project applicant has demonstrated that it is technically infeasible to retain 100 percent of the SWQDv on-site.
- Hydromodification requirements of Section VI.D.7.c.iv of the Los Angeles County MS4 Permit must be considered separately regardless of what type of biofiltration is used.
- Operation and maintenance of Filterra systems must be conducted consistent with the recommendations in the Filterra maintenance manual provided by Contech Engineered Solutions.
- In the area governed by the Los Angeles Region Phase I stormwater permit, conventional biofilters must be sized to treat 1.5X the SWQDv. This results in an average annual capture rate of 93%. Filterra systems sized using this tool will also treat at least 93% of the average annual runoff volume.



### Filterra Sizing Tool

Applicable in the Area Governed by the Los Angeles County MS4 Permit  
(NPDES PERMIT NO. CAS004001; ORDER NO. R4-2012-0175)

**For final design please contact:**  
**Maryjane Mac Leod - Stormwater Consultant**  
[mmacleod@conteches.com](mailto:mmacleod@conteches.com)  
**Phone: 818-519-1781**

Contact Information		Project Information	
Engineer of Record Name	Michael Burgess	Project Name	Artesia - Compton Retail
Engineer of Record Company Name	PM Design Group, Inc.	Project Location	Compton, CA
Engineer of Record Office Zip Code	95404	Catchment Name	Watershed 4

Drainage Area Inputs		
Drainage Area	14735	ft <sup>2</sup>
Runoff coefficient	0.8792	-
Time of concentration	9	min
Long term reliable infiltration rate	0.09	in/hr
85th percentile, 24-hour depth (see hyperlink below)	0.86	in

[LA County Rainfall Depth Analysis](#)

Filterra Configuration (Select from Drop-Down)	Internal Bypass Curb - Chamber
Refer to "Filterra Configurations" tab for descriptions and standard details for download.	

Constants		
LAX Airport 85th Percentile, 24-hour depth (for reference only)	1.02	in
Filterra hydraulic loading capacity	1.45	gpm/ft <sup>2</sup>
Outputs		
Stormwater Quality Design Volume	928	ft <sup>3</sup>
Design Rainfall Intensity for Equivalent Long Term Capture	0.387	in/hr
Site Scaling Factor	0.84	-
Stormwater Quality Design Flow Rate	0.10	cfs
Design Alternatives Available	<b>Stand Alone Filterra Permitted</b>	

Design Recommendations		
<i>Primary Recommendation - Stand Alone Filterra</i>		
Adjusted Filterra Design Intensity	0.574	in/hr
Stormwater Quality Design Flow Rate	0.15	cfs
Required Filterra Area	45	ft <sup>2</sup>
Filterra Model ID	<b>FTIBC-C 6x8 / 8x6</b>	
<i>Alternative Recommendation - Filterra + Infiltration Storage</i>		
Required Filterra Area	31	ft <sup>2</sup>
Filterra Model ID	<b>FTIBC-C 6x6</b>	
ChamberMaxx volume	124	ft <sup>3</sup>
ChamberMaxx count	2	chambers

To be consistent with approval of the Filterra Bioretention System as an alternative biofiltration specification granted by the Los Angeles Regional Water Quality Control Board on October 9, 2017, Filterra use is subject to the following conditions:

- Filterra systems must be designed and sized following the methodology in Section 4 of the August 2015 report prepared by Geosyntec Consultants, entitled "Filterra Equivalency Analysis and Design Criteria" which is the basis for this design tool.
- Filterra systems use an engineered biofiltration media. Filterra systems, including the engineered biofiltration media, must be provided by the manufacturer. No substitution of materials/media is allowed.
- Filterra is only applicable as an alternative on-site biofiltration design in situations where a project applicant has demonstrated that it is technically infeasible to retain 100 percent of the SWQDv on-site.
- Hydromodification requirements of Section VI.D.7.c.iv of the Los Angeles County MS4 Permit must be considered separately regardless of what type of biofiltration is used.
- Operation and maintenance of Filterra systems must be conducted consistent with the recommendations in the Filterra maintenance manual provided by Contech Engineered Solutions.
- In the area governed by the Los Angeles Region Phase I stormwater permit, conventional biofilters must be sized to treat 1.5X the SWQDv. This results in an average annual capture rate of 93%. Filterra systems sized using this tool will also treat at least 93% of the average annual runoff volume.





### Filterra Sizing Tool

Applicable in the Area Governed by the Los Angeles County MS4 Permit  
(NPDES PERMIT NO. CAS004001; ORDER NO. R4-2012-0175)

**For final design please contact:**  
**Maryjane Mac Leod - Stormwater Consultant**  
[mmacleod@conteches.com](mailto:mmacleod@conteches.com)  
**Phone: 818-519-1781**

Contact Information		Project Information	
Engineer of Record Name	Michael Burgess	Project Name	Artesia - Compton Retail
Engineer of Record Company Name	PM Design Group, Inc.	Project Location	Compton, CA
Engineer of Record Office Zip Code	95404	Catchment Name	Watershed 5

Drainage Area Inputs		
Drainage Area	42718	ft <sup>2</sup>
Runoff coefficient	0.7762	-
Time of concentration	22	min
Long term reliable infiltration rate	0.09	in/hr
85th percentile, 24-hour depth (see hyperlink below)	0.86	in

**Filterra Configuration (Select from Drop-Down)**      **Internal Bypass Curb - Chamber**  
Refer to "Filterra Configurations" tab for descriptions and standard details for download.

Constants		
LAX Airport 85th Percentile, 24-hour depth (for reference only)	1.02	in
Filterra hydraulic loading capacity	1.45	gpm/ft <sup>2</sup>

Outputs		
Stormwater Quality Design Volume	2,376	ft <sup>3</sup>
Design Rainfall Intensity for Equivalent Long Term Capture	0.335	in/hr
Site Scaling Factor	0.84	-
Stormwater Quality Design Flow Rate	0.22	cfs
Design Alternatives Available	<b>Stand Alone Filterra Permitted</b>	

Design Recommendations		
<i>Primary Recommendation - Stand Alone Filterra</i>		
Adjusted Filterra Design Intensity	0.478	in/hr
Stormwater Quality Design Flow Rate	0.31	cfs
Required Filterra Area	96	ft <sup>2</sup>
Filterra Model ID	<b>FTIBC-C 8x12 / 12x8</b>	

<i>Alternative Recommendation - Filterra + Infiltration Storage</i>		
Required Filterra Area	68	ft <sup>2</sup>
Filterra Model ID	<b>FTIBC-C 7x11 / 11x7</b>	
ChamberMaxx volume	318	ft <sup>3</sup>
ChamberMaxx count	5	chambers

To be consistent with approval of the Filterra Bioretention System as an alternative biofiltration specification granted by the Los Angeles Regional Water Quality Control Board on October 9, 2017, Filterra use is subject to the following conditions:

- Filterra systems must be designed and sized following the methodology in Section 4 of the August 2015 report prepared by Geosyntec Consultants, entitled "Filterra Equivalency Analysis and Design Criteria" which is the basis for this design tool.
- Filterra systems use an engineered biofiltration media. Filterra systems, including the engineered biofiltration media, must be provided by the manufacturer. No substitution of materials/media is allowed.
- Filterra is only applicable as an alternative on-site biofiltration design in situations where a project applicant has demonstrated that it is technically infeasible to retain 100 percent of the SWQDv on-site.
- Hydromodification requirements of Section VI.D.7.c.iv of the Los Angeles County MS4 Permit must be considered separately regardless of what type of biofiltration is used.
- Operation and maintenance of Filterra systems must be conducted consistent with the recommendations in the Filterra maintenance manual provided by Contech Engineered Solutions.
- In the area governed by the Los Angeles Region Phase I stormwater permit, conventional biofilters must be sized to treat 1.5X the SWQDv. This results in an average annual capture rate of 93%. Filterra systems sized using this tool will also treat at least 93% of the average annual runoff volume.

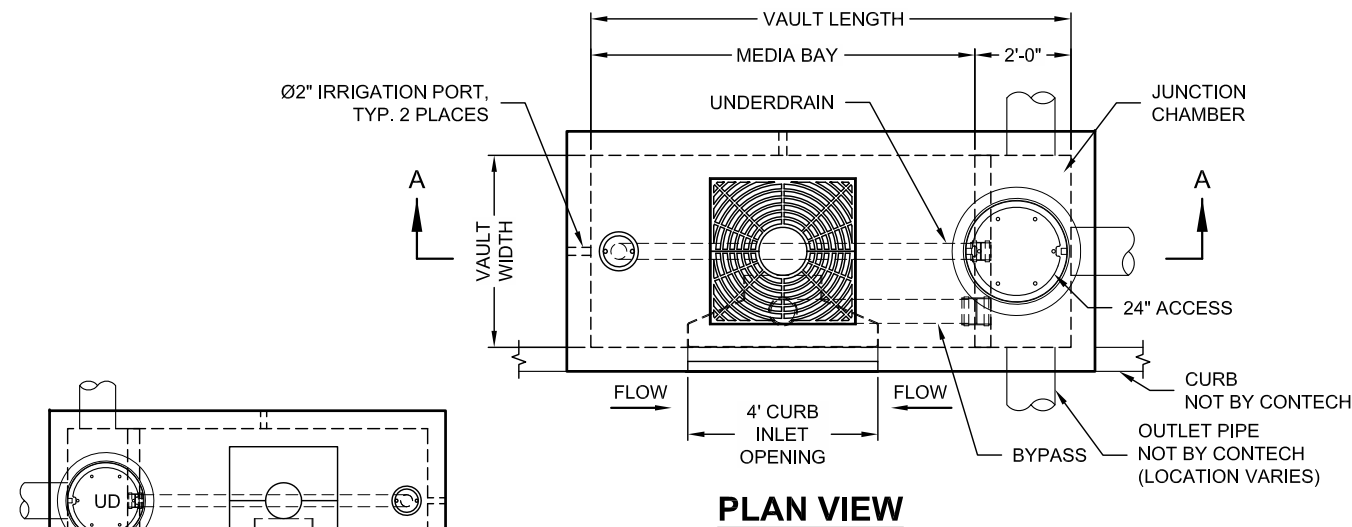

**PLAN VIEW**

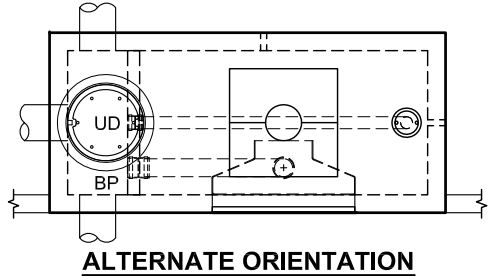

**ALTERNATE ORIENTATION**

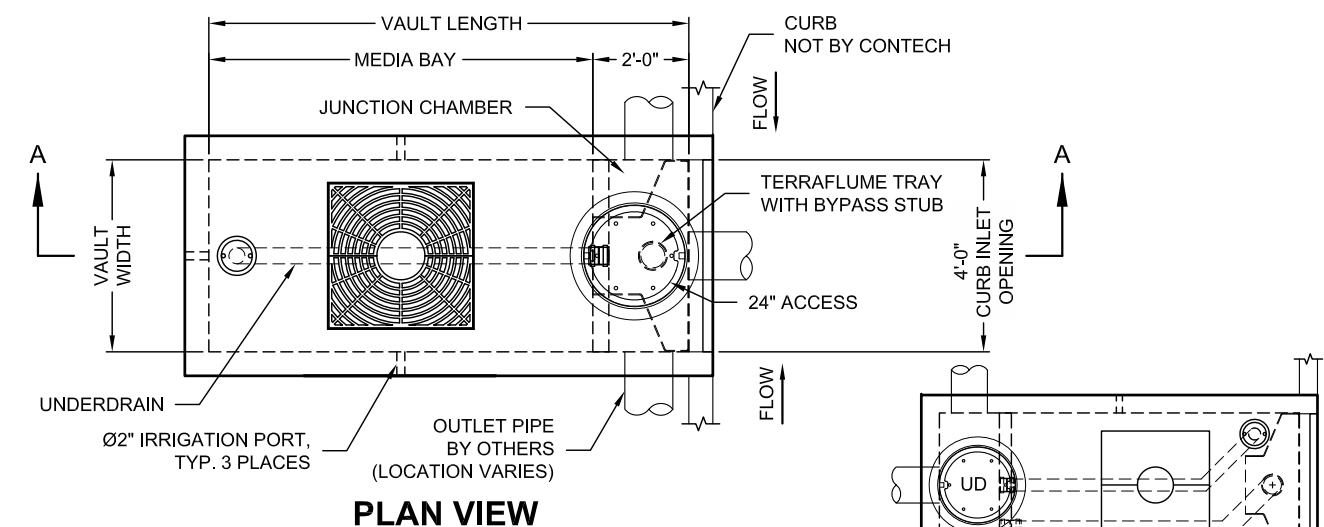

**PLAN VIEW**

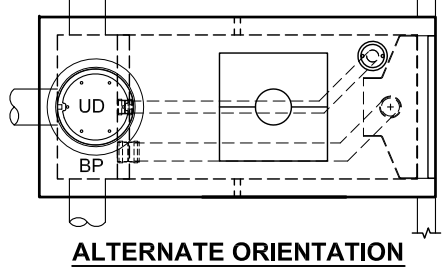

**ALTERNATE ORIENTATION**

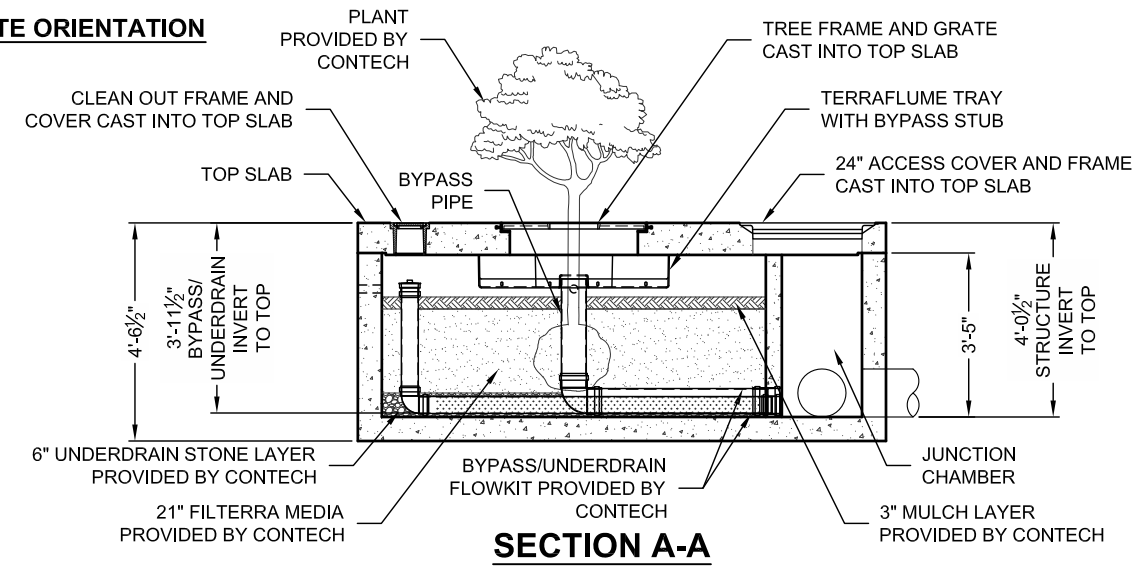

**SECTION A-A**

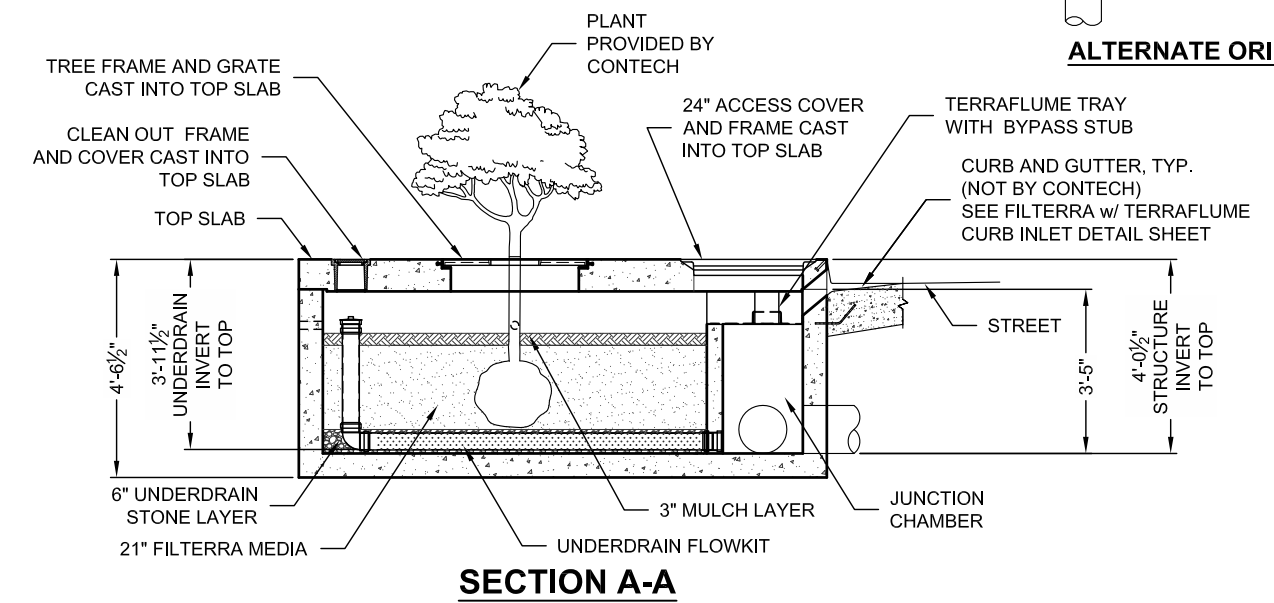

**SECTION A-A**

FTIBC-C LONG SIDE CURB INLET							
DESIGNATION (LONG SIDE)	SIZE (MEDIA BAY)	VAULT LENGTH	VAULT WIDTH	MAX. BYPASS PIPE SIZE	MAX. BYPASS FLOW (CFS)	UNDERDRAIN PIPE DIA. (PERF.)	TREE GRATE QTY. & SIZE
FTIBC-C0404 LS	4' x 4'	6'-0"	4'-0"	6" SDR 35	1.42	4" SDR 35	(1) 3' x 3'
FTIBC-C0604	6' x 4'	8'-0"	4'-0"	8" SDR 35	1.89	4" SDR 35	(1) 3' x 3'
FTIBC-C0606 LS	6' x 6'	8'-0"	6'-0"	10" SDR 35	2.37	4" SDR 35	(1) 3' x 3'
FTIBC-C0804	8' x 4'	10'-0"	4'-0"	8" SDR 35	1.89	4" SDR 35	(1) 3' x 3'
FTIBC-C0806	8' x 6'	10'-0"	6'-0"	10" SDR 35	2.37	4" SDR 35	(1) 4' x 4'
FTIBC-C1006	10' x 6'	12'-0"	6'-0"	10" SDR 35	2.37	6" SDR 35	(1) 4' x 4'
FTIBC-C1204	12' x 4'	14'-0"	4'-0"	8" SDR 35	1.89	4" SDR 35	(2) 3' x 3'
FTIBC-C1206	12' x 6'	14'-0"	6'-0"	10" SDR 35	2.37	6" SDR 35	(2) 4' x 4'
FTIBC-C1307	13' x 7'	15'-0"	7'-0"	10" SDR 35	2.37	6" SDR 35	(2) 4' x 4'

INTERNAL PIPE CONFIGURATION MAY VARY DEPENDING ON VAULT SIZE

FTIBC-C SHORT SIDE CURB INLET							
DESIGNATION (SHORT SIDE)	SIZE (MEDIA BAY)	VAULT LENGTH	VAULT WIDTH	MAX. BYPASS PIPE SIZE	MAX. BYPASS FLOW (CFS)	UNDERDRAIN PIPE DIA. (PERF.)	TREE GRATE QTY. & SIZE
FTIBC-C0404 SS	4' x 4'	6'-0"	4'-0"	6" SDR 35	1.42	4" SDR 35	(1) 3' x 3'
FTIBC-C0406	4' x 6'	8'-0"	4'-0"	8" SDR 35	1.89	4" SDR 35	(1) 3' x 3'
FTIBC-C0408	4' x 8'	10'-0"	4'-0"	8" SDR 35	1.89	4" SDR 35	(1) 3' x 3'
FTIBC-C0412	4' x 12'	14'-0"	4'-0"	8" SDR 35	1.89	4" SDR 35	(2) 3' x 3'
FTIBC-C0606 SS	6' x 6'	8'-0"	6'-0"	10" SDR 35	2.37	4" SDR 35	(1) 3' x 3'
FTIBC-C0608	6' x 8'	10'-0"	6'-0"	10" SDR 35	2.37	4" SDR 35	(1) 4' x 4'
FTIBC-C0610	6' x 10'	12'-0"	6'-0"	10" SDR 35	2.37	6" SDR 35	(1) 4' x 4'
FTIBC-C0612	6' x 12'	14'-0"	6'-0"	10" SDR 35	2.37	6" SDR 35	(2) 4' x 4'
FTIBC-C0713	7' x 13'	15'-0"	7'-0"	10" SDR 35	2.37	6" SDR 35	(2) 4' x 4'

INTERNAL PIPE CONFIGURATION MAY VARY DEPENDING ON VAULT SIZE

\* DIMENSIONS MAY VARY ± 1/8" DEPENDING ON PRECASTER BUILD CONFIGURATION.



The design and information shown on this drawing is provided as a service to the project owner, engineer and contractor by Contech Engineered Solutions LLC or one of its affiliated companies ("Contech"). Neither this drawing, nor any part thereof, may be used, reproduced or modified in any manner without the prior written consent of Contech. Failure to comply is done at the user's own risk and Contech expressly disclaims any liability or responsibility for such use. If discrepancies between the supplied information upon which the drawing is based and actual field conditions are encountered as site work progresses, these discrepancies must be reported to Contech immediately for re-evaluation of the design. Contech accepts no liability for designs based on missing, incomplete or inaccurate information supplied by others.

**CONTECH**  
ENGINEERED SOLUTIONS LLC  
www.ContechES.com  
9025 Centre Pointe Dr., Suite 400, West Chester, OH 45069  
800-338-1122 513-645-7000 513-645-7993 FAX

**FILTERRA**  
INTERNAL BYPASS CURB WITH CHAMBER (FTIBC-C)  
CONFIGURATION DETAILS