

**PRELIMINARY REGULATORY DEVELOPMENT
SECTION 316(B) OF THE CLEAN WATER ACT**

***BACKGROUND PAPER NUMBER 3:
COOLING WATER INTAKE TECHNOLOGIES***

April 4, 1994

Prepared for:

U.S. Environmental Protection Agency
Office of Wastewater Enforcement and Compliance
Permits Division
401 M Street S.W.
Washington, D.C. 20460

Prepared by:

Science Applications International Corporation
7600-A Leesburg Pike
Falls Church, VA 22043

EPA Contract No. 68-C8-0066; Work Assignment No. C-5-55(P)
SAIC Project No. 01-0833-03-6957-003



1
2
3
4
5
6
7
8
9
10
11
12
13
14
15
16
17
18
19
20
21
22
23
24
25
26
27
28
29
30
31
32
33
34
35
36
37
38
39
40
41
42
43
44
45
46
47
48
49
50
51
52
53
54
55
56
57
58
59
60
61
62
63
64
65
66
67
68
69
70
71
72
73
74
75
76
77
78
79
80
81
82
83
84
85
86
87
88
89
90
91
92
93
94
95
96
97
98
99
100



TABLE OF CONTENTS

	<u>Page</u>
1. INTRODUCTION AND METHODOLOGY	1-1
2. COOLING WATER INTAKE CONSIDERATIONS	2-1
2.1 Cooling Water Intake Flows and Sources	2-1
2.2 Impacts and Problems Associated with Cooling Water Withdrawal from Surface Waters	2-1
2.2.1 Entrainment and/or Impingement	2-2
2.2.2 Biofouling and Corrosion	2-2
2.3 Mitigation Techniques	2-2
2.3.1 Location of Cooling Water Intakes	2-3
2.3.2 Cooling Water Flow Reduction Techniques	2-3
2.3.3 Cooling Water Intake Technologies	2-5
3. INTAKE TECHNOLOGY REVIEW	3-1
3.1 Intake Screen Systems	3-1
3.1.1 Summary of Findings: Intake Screen Systems	3-2
3.1.2 Conclusions: Intake Screen Systems	3-5
3.2 Passive Intake Systems (Physical Exclusion Devices)	3-6
3.2.1 Summary of Findings: Passive Intake Systems	3-6
3.2.2 Conclusions: Passive Intake Systems	3-7
3.3 Fish Diversion and/or Avoidance Systems	3-8
3.3.1 Summary of Findings: Fish Diversion and/or Avoidance Systems	3-8
3.3.2 Conclusions: Fish Diversion and/or Avoidance Systems	3-11
4. SUMMARY AND NEXT STEPS	4-1
REFERENCES	1
APPENDIX A	A-1

- For large facilities, the flow of water required may be unacceptably large (ASCE, 1982; Ray et al., 1976).

REFERENCES:

ASCE. Design of Water Intake Structures for Fish Protection. American Society of Civil Engineers. 1982.

Mussali, Y.G., E.P. Taft III, and J. Larson. "Offshore Water Intakes Designed to Protect Fish." Journal of the Hydraulics Division Proceedings of the American Society of Civil Engineers. Vol. 106 Hy11 (1980): 1885-1901.

Mussali, Y.G., E.P. Taft, and P. Hoffman. "Engineering Implications of New Fish Screening Concepts." In Fourth National Workshop on Entrainment and Impingement, L.D. Jensen (Editor), Ecological Analysts, Inc. Melville, NY. Chicago, IL. December 1977.

Ray, S.S., R.L. Snipes, and D.A. Tomljanovich. A State-of-the-Art Report on Intake Technologies. Prepared for Office of Energy, Minerals, and Industry, Office of Research and Development. U.S. Environmental Protection Agency, Washington, DC by the Tennessee Valley Authority. EPA 600/7-76-020. October 1976.

ADDITIONAL REFERENCES:

Stone and Webster Engineering Corporation. Engineering Feasibility of Fish Behavioral Barriers. Report prepared for Niagara Mohawk Power Corporation and Rochester Gas & Electric Power Corporation. 1977.

Stone and Webster Engineering Corporation. Studies to Alleviate Fish Entrapment at Power Plant Cooling Water Intakes—Final Report. Prepared for Niagara Mohawk Power Corporation and Rochester Gas & Electric Power Corporation. 1976.

LIST OF TABLES

	<u>Page</u>
Table 3-1. Cooling Water Intake Technologies by System Category (with corresponding fact sheet number)	3-2

TESTING FACILITIES AND/OR FACILITIES USING THE TECHNOLOGY:

- Water jet curtains were tested for the Niagara Mohawk Power Corporation and Rochester Gas and Electric Corporation in the mid-seventies (Mussalli, 1977). It is not known whether any facilities use the technology now.

RESEARCH/OPERATION FINDINGS:

- Laboratory studies have shown that water jets with 60 pounds per square inch (psi) pressure from 1/32 or 1/16 inch in diameter nozzles in a diffuser pipe oriented at a 30 degree angle to the intake structure are moderately effective in diverting fish (Mussalli, 1977).
- Studies at large-scale testing facilities have shown this technology to be relatively ineffective (ASCE, 1982).
- Tests by the U.S. Bureau of Commercial Fisheries have shown efficiencies for water jet curtains at 60 to 80 percent under varied water pressure, array angles, and approach systems (Ray et al., 1976).

DESIGN CONSIDERATIONS:

- For offshore intakes, vertical bars should be placed about 1 foot apart to prevent potential blockage of the intake from accumulation of debris (Mussalli, 1977).
- Because the strength of the submerged water jet decreases rapidly, it is recommended that two rows of closely spaced nozzles be oriented so that they are jetting toward each other to create an effective curtain (Mussalli, 1977).
- Consideration should be given to problems associated with icing, siltation, and wave action (Mussalli, 1977).
- Warm water in the jets can be used to reduce the potential of frazil ice formations (Mussalli, 1980).

ADVANTAGES:

- Water jet curtains provide the flexibility to use or not use the system during certain periods of time, as appropriate.

LIMITATIONS:

- The water supply for the water jets must be filtered to prevent clogging of the small nozzle openings (Mussalli, 1977).
- Maintenance is required to prevent clogging of the nozzles, particularly in a marine environment, and may be extensive (ASCE, 1982).

1. INTRODUCTION AND METHODOLOGY

The purpose of this paper is to present the findings of an initial examination of cooling water intake technologies currently used or being tested for minimizing the loss of aquatic organisms due to entrainment and impingement effects. The paper also provides a brief discussion of flow reduction techniques and intake siting considerations. The information is intended to be used by the U.S. Environmental Protection Agency (EPA) as baseline data for evaluating the range of future regulatory options under Section 316(b) of the Clean Water Act (CWA).

Background Paper 2, entitled "Cooling Water Use for Selected U.S. Industries and Summary of Selected EPA Regional and State Section 316(b) Activities", described the cooling water uses and flows for the steam electric power generation industry and for various manufacturing industries. Paper 2 indicated that the majority of high flow water use industries (including steam electric power plants) use private intake water supplies from fresh, brackish, and marine sources. To supply these intake flows, steam electric power plants and other industrial facilities must construct some type of intake structure capable of handling the large flows of intake water. These structures are designed to allow the free flow of water, but must also ensure that organic and inorganic debris does not enter the system and cause damage to pumps, equipment, or cooling system condensers and/or heat exchangers. In accordance with Section 316(b), these intake structures must also be located, designed, and constructed utilizing the best technology available to minimize adverse environmental impact.

To identify technologies used at cooling water intakes, the available literature was reviewed. Most of the literature available is related to the technologies used by the steam electric industry. This industry withdraws the bulk of the cooling water used in the United States. However, information on technologies used at other types of water intakes, such as those for desalinization plants, water supply systems, hydroelectric facilities, and irrigation systems, was also reviewed. It should be noted that the literature reviewed for this initial examination does not represent an exhaustive list of all the available information on each technology. Because of time and resource constraints, the literature search was limited to those resources that could be identified and obtained within a reasonable period of time.

This paper discusses the impacts of high flow cooling water intakes and the location, design and operational technologies that have been developed to mitigate these impacts. Section 2 of this paper presents background information regarding cooling water intake and use, effects of cooling water withdrawal, and techniques for minimizing these effects. Section 3 categorizes intake control technologies into system types and presents a listing of the various technologies identified as a result of this research effort. Section 3 continues by discussing the operation and use of the intake technologies investigated. Section 4 summarizes all of the technology types reviewed and offers some recommendations for additional study. Finally, Appendix A contains detailed fact sheets for each of the technologies identified. The fact sheets provide pertinent information on the frequency of use, design considerations, field testing results, and advantages and limitations for each technology reviewed.

DESCRIPTION:

Water jet curtains typically consist of a row of vertical pipes placed in front of the cooling water intake (see figure below). Nozzles are fitted at regular intervals the length of the pipes to produce a lateral curtain of water when operating. These jets produce a curtain of high pressure water, which is intended to deter the fish from entering the intake area. A typical jet curtain might have vertical pipes 3/4 inches in diameter, spaced 1 foot apart with nozzles (openings as small as 1/32 inch) spaced at 0.5 inch on center (ASCE, 1982; Mussalli, 1979).

Water jet curtains have not been used in many actual applications to date. Testing has not shown the efficiency of the technology to be appropriate for use alone to divert fish from cooling water intakes. However, this technology may be used in conjunction with other technologies to provide an efficient fish diversion system.

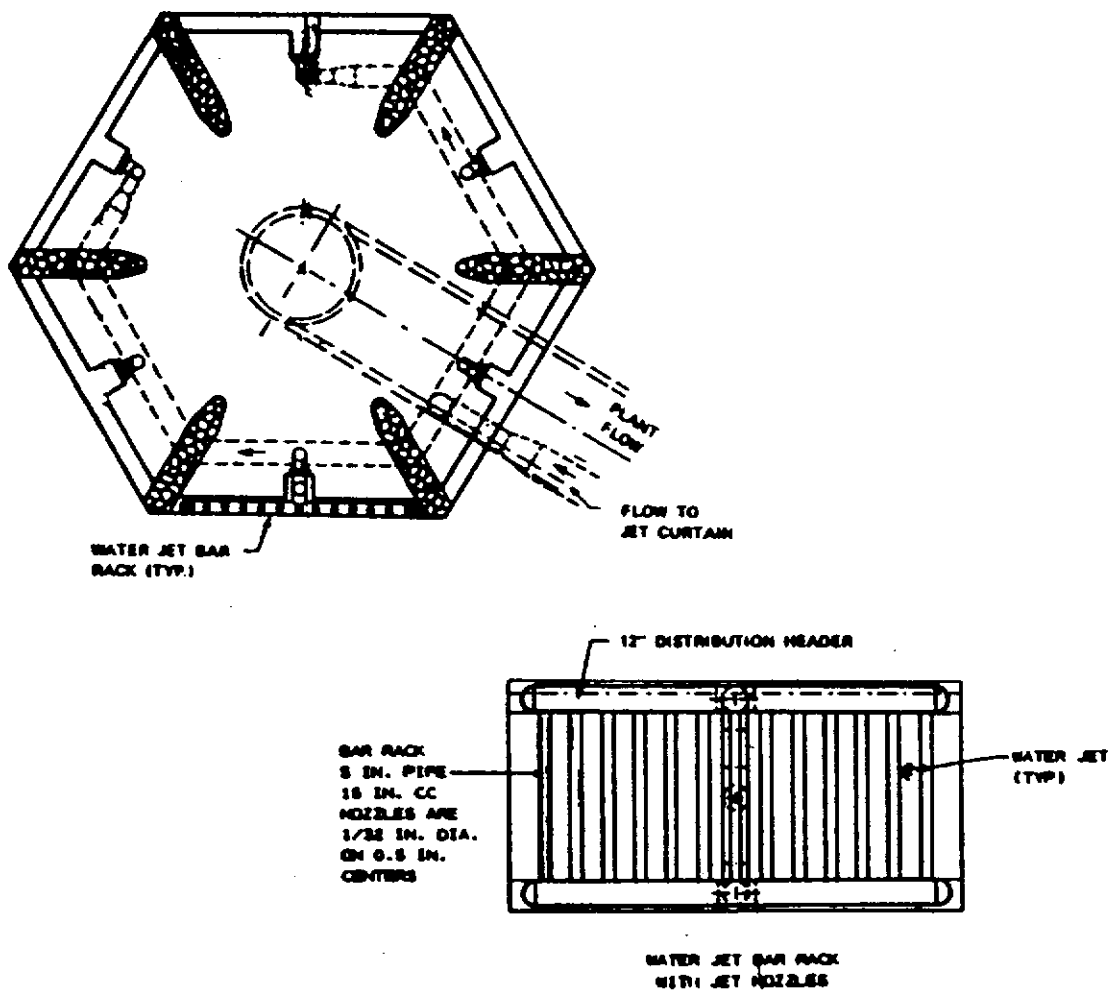

Intake With Water Jet Curtains (Mussalli et al., 1980)



LIMITATIONS:

- Cable and chain barriers are less effective at night.
- Cable and chain barriers do not exclude all fish.

REFERENCES:

EPRI. Intake Research Facilities Manual. Prepared by Lawler, Matusky & Skelly Engineers, Pearl River, for Electric Power Research Institute. EPRI CS-3976. May 1985.

Haddingh, R.H. "Fish Intake Mortality at Power Stations, the Problem and Its Remedy." N.V. Kema, Arnheem, Netherlands. Hydrological Bulletin 13(2-3) (1979): 83-93.

Mussalli, Y.G., E.P Taft III, and J. Larson. "Offshore Water Intakes Designed to Protect Fish." Journal of the Hydraulics Division Proceedings of the American Society of Civil Engineers, Vol. 106 Hy11 (1980): 1885-1901.

Ray, S.S., R.L. Snipes, and D.A. Tomljanovich. A State-of-the-Art Report on Intake Technologies. Prepared for Office of Energy, Minerals, and Industry, Office of Research and Development. U.S. Environmental Protection Agency, Washington, DC by the Tennessee Valley Authority. EPA 600/7-76-020. October 1976.

ADDITIONAL REFERENCES:

Brett, J.R., and D.F. Alderdice. "Lakelse River Experiments on Guiding Sockeye and Coho Salmon Fingerlings." Canadian Fish. Res. Board. Progr. Reports of Pacific Coast Stations No. 106 (1956): 14-20.

Brett, J.R., D. Mackinnon, and D.F. Alderdice. "Trough Experiments on Guiding Sockeye Salmon Fingerlings." Canadian Fish. Res. Board. Progr. Reports of Pacific Coast Stations No. 99 (1954): 24-27.

Foster, J.R. "Benthic Net and Chain Curtain for Fish Diversion." Presented at the Workshop on Advanced Intake Technologies. San Diego, CA. U.S. Fish and Wildlife Service. Washington, DC. 1981.

2. COOLING WATER INTAKE CONSIDERATIONS

This section discusses cooling water intake practices at steam electric power plants and other industrial manufacturing facilities. Initially, a brief summary of cooling water intake flows and sources is provided along with a discussion of the potential problems and impacts associated with the withdrawal of large flows of cooling waters from surface water sources. Finally, this section discusses the types of mitigation techniques that may be considered to minimize impacts to aquatic organisms at cooling water intakes.

2.1 Cooling Water Intake Flows and Sources

The findings in Background Paper 2 indicate that the 2,417 power generation units of the U.S. steam electric industry withdrew approximately 303,350 million gallons per day (MGD) in 1991. This equates to an average of approximately 125.5 MGD per generation unit. Of this total, approximately 208,300 MGD (68.7 percent) were withdrawn from a fresh water source, 50,000 MGD (16.5 percent) were withdrawn from a saline water source, and 42,800 MGD (14.1 percent) were withdrawn from a brackish water source. The remaining 0.7 percent was withdrawn from groundwater, municipal effluent, and municipal water supplies (EEI, 1993).

Non-steam electric generation facilities used a total intake (for all uses) of approximately 28,600 MGD and had a total cooling water intake flow of approximately 16,000 MGD in 1982. Of this total, the four industrial categories withdrawing the highest flows of cooling water reported an average withdrawal of 4.86 MGD per facility. These four industrial categories also reported that an average of 70 to 90 percent of their total flows were from private surface water systems (USDOC, 1983).

Based on these findings, it is evident that nearly all steam electric facilities, and the majority of other industrial facilities withdrawing large flows of cooling water use surface water sources (fresh, saline or brackish).

2.2 Impacts and Problems Associated with Cooling Water Withdrawal from Surface Waters

Inherent in the use of surface waters as a source, is the need for the construction of an intake structure into that water source. Because of the large flows of water withdrawn at cooling water intake structures, organic and inorganic matter present in the water source may be inadvertently drawn into the intake. Aquatic organisms may be injured and/or killed through entrainment or impingement if drawn into the cooling water intakes. In addition, intake of these materials may cause biofouling and corrosion and can seriously damage pumps and equipment at steam electric power plants and other industrial facilities that take in large flows of cooling water. Cooling water intake structures, therefore, should be designed to minimize the intake of these unwanted materials.

TESTING FACILITIES AND/OR FACILITIES USING THE TECHNOLOGY:

- Testing of a chain curtain was performed from 1978 to 1979 at the Nantioke Thermal Generating Station in Ontario, Canada (EPRI, 1985). No other testing facilities were identified in the literature.

RESEARCH/OPERATION FINDINGS:

- Experimental results have shown that if the chain barrier is moved horizontally through the water, fish diversion efficiency is improved (Haddingh, 1979).
- The effectiveness of chain barriers may be dependent upon water flow, depth of the water intake area, and turbidity of the water (Haddingh, 1979).
- A chain barrier tested by model was shown to be moderately effective in warm water and ineffective in cold water (ASCE, 1982).
- At a plant on the Hudson River, cable and chain barriers were shown to be ineffective altogether (ASCE, 1982).
- In laboratory tests performed by the University of Washington and the Fisheries Research Board in Canada, chain barriers were shown to be more effective in the daylight than at nighttime. Maximum efficiencies of 94 and 71 percent in day and night applications, respectively, were obtained in Canadian studies using migrating Sockeye salmon with chains spaced at 5 centimeters and hung at a 45 degree angle to the flow. These tests were performed in both still water and moving water, at different angles to the flow, and at several different spacing combinations of chains (Ray et al., 1976).

DESIGN CONSIDERATIONS:

- A model facility to test the cable and chain barrier installed an array of 3/16 inch chain lengths each 3 feet long and spaced on 2-inch centers. The actual spaces between the chain were 1.25 inches (Mussalli, 1980).
- Operational problems due to the wave action, debris, and icing should be considered (Mussalli, 1980).
- Chains should be placed far enough away from the intake structure to eliminate entanglement and to allow flow into the structure should the chains clog with debris or ice (Mussalli, 1980).

ADVANTAGES:

- Cable and chain barriers are relatively low in cost and maintenance free if designed properly.

2.2.1 Entrainment and/or Impingement

The process of withdrawing surface waters from fresh, marine, or brackish sources for use as cooling water may result in the entrainment (i.e., drawing in) of small aquatic organisms, such as fish eggs and larvae, and the impingement (i.e., trapping and holding) of larger organisms, such as fish and shellfish, against the outer part the cooling water intake structure. In addition, entrainment and/or impingement can cause injury and/or mortality to these organisms.

Entrainment damage to small organisms may occur as a result of their passage through the plant's condenser cooling system. Mortality to organisms can occur because of (1) physical impact made with pump and condenser tubing, (2) pressure changes caused by diversion of cooling water, (3) thermal shock experienced in condenser and discharge tunnels, and (4) chemical toxemia induced by the addition of anti-fouling agents such as chlorine. Impingement of fish species is mainly caused by hydraulic forces in the intake stream. Mortality to fish may result from (1) starvation and exhaustion, (2) asphyxiation when the fish have forced against a screen by velocity forces that prevent proper gill movement, (3) abrasion by screen wash spray, and (4) by asphyxiation due to the fish's removal from water for prolonged periods (EPA, 1976).

2.2.2 Biofouling and Corrosion

While the intake of large flows of cooling water can impact aquatic organisms through entrainment and impingement, these same organisms can adversely affect the cooling and condensing systems at steam electric power plants or other manufacturing facilities through "biofouling." Biofouling is the industry term for the buildup of macro- and microscopic organisms within the water intake structure and cooling and condensing systems. These buildups can cause clogging and deterioration of condensers and heat exchangers can also obstruct flows at the intake structure. In addition to aquatic organisms, inorganic contaminants such as debris (trash) and sediment can cause clogging and corrosion of intake pumps, condensers, heat exchangers, and manufacturing equipment.

It is to the facilities' advantage, therefore, to limit the intake of these materials in order to protect plant equipment and processes. These problems are mentioned here because many of the intake technologies described in the following sections are designed primarily to prevent the intake of trash and to limit biofouling and corrosion; the technologies are not specifically designed to prevent entrainment or impingement.

2.3 Mitigation Techniques

There are three main approaches that can be taken to minimize adverse environmental impacts caused by the withdrawal of cooling water from surface waters. These approaches include: 1) evaluation of ecological issues when intake siting decisions are made; 2) reduction of cooling water intake flows; and 3) installation of control technologies at the cooling water intake structure. Each of these approaches are discussed in the following sections.

**FISH DIVERSION OR AVOIDANCE
SYSTEMS**

FACT SHEET NO. 24

CABLE AND CHAIN BARRIERS

DESCRIPTION:

Cable and chain barriers (sometimes called "hanging chain curtains") consist of cables or chains suspended vertically in front of the cooling water intake (see figure below). These systems are designed to take advantage of fish behavior and the tendency of fish to avoid objects moving through the water (Ray et al., 1976). This curtain can be moved horizontally through the water to create turbulent flows, which fish will sense and avoid.

Conclusions in most of the testing conducted to date are that the technology shows little promise for diverting fish at cooling water intakes.

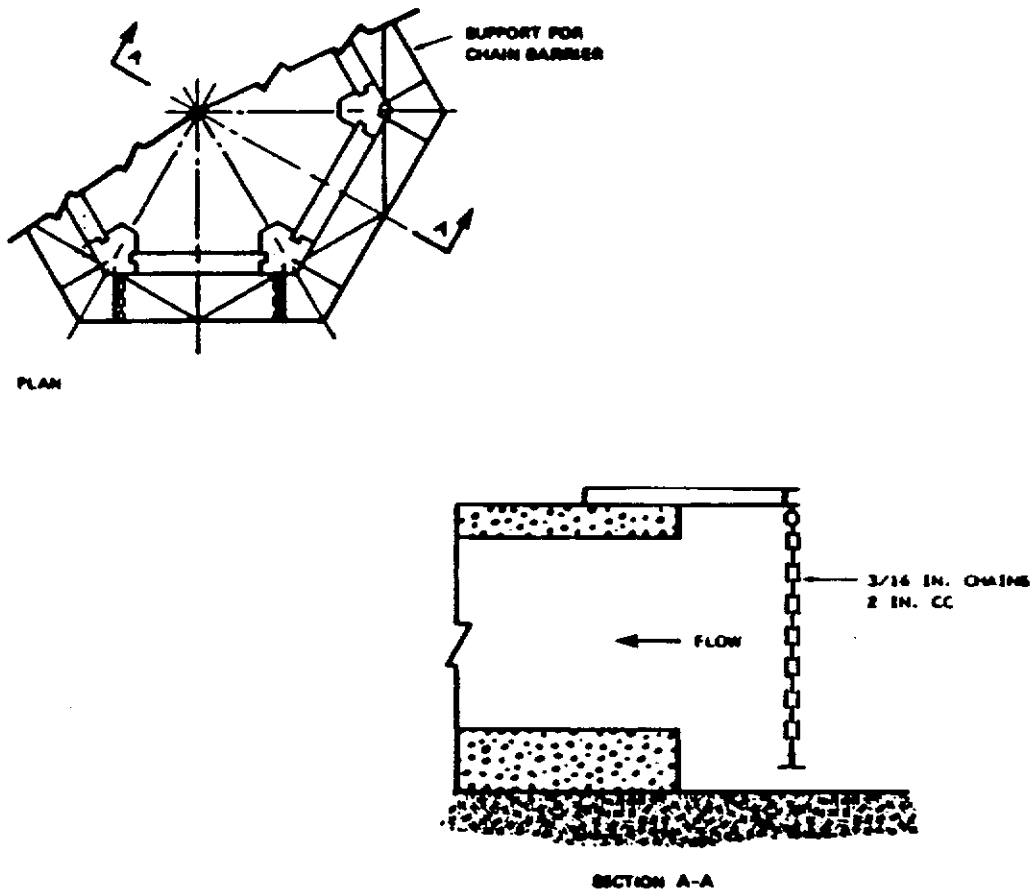

Offshore Intake With Hanging Chain Barriers (Mussalli et al., 1980)

2.3.1 Location of Cooling Water Intakes

The first approach that can be taken to minimize adverse aquatic impacts from cooling water intakes is the location of the cooling water intake structure. There are three principal environmental concerns related to intake location: intake operation, construction activities, and aesthetics. For the purposes of this paper, only the mitigation practices related to intake operation will be discussed.

To properly characterize the site, a facility may need to perform an extensive geographical and ecological survey in the vicinity of the proposed site. The survey data are then used to determine potential impacts that may be caused to important wildlife and aquatic breeding, nursery, feeding, and/or migration areas. Furthermore, the survey data might enable determinations to be made with regard to concentrations of aquatic life within specific and proposed siting areas. In addition to ecological considerations, the final selection of an intake location is dependent on physical characteristics of the proposed water body as well as hydraulic and economic factors.

A principal factor determining the potential impact of an intake location is the water source. As stated earlier in Section 2.1, the most common water sources are fresh water rivers, fresh water lakes and reservoirs, estuaries, and oceans. Each of these sources has unique flow characteristics that must be considered in the location of the intake structure. Intake structure design and siting considerations related to the water source include, direction and rate of stream flow, flooding, ice and ice flows, tidal influences, thermal stratification, salinity and currents (EPA, 1973).

Other intake siting considerations include the proximity of the effluent discharge point, distance from the shoreline, the water depth of the intake structure, and the proximity of sensitive biological communities. Each of these factors should be assessed to determine possible environmental impacts and the intake location established to minimize the impact.

2.3.2 Cooling Water Flow Reduction Techniques

The second approach that can be taken to minimize the adverse aquatic impacts of cooling water intake structures is to reduce the rate and degree to which cooling water is withdrawn. Reductions in cooling water intake flow will reduce entrainment and impingement impacts. Once-through cooling systems have been found to cause higher rates of entrainment because of the considerable and continuous amount of water used by these systems as compared to the flows used by closed-cycle systems.

Steam electric power plants may be designed to use cooling water in a once-through, system a closed-cycle system, or a combination of the two. Once-through cooling systems withdraw water from a replenishable source (e.g., river, estuary or ocean), run the water through condensers, and then discharge the withdrawn water without recirculation.

Closed-cycle systems extract cooling water from a natural source, or from a plant's own dedicated cooling pond, or some other source. Unlike the once-through system, cooling water in a closed-cycle system is recirculated. Closed-cycle systems generally utilize some type of

C.H. Hocutt. "Behavioral Barriers and Guidance Systems." In Power Plants: Effects on Fish and Shellfish Behavior. C.H. Hocutt, J.R. Stauffer, Jr., J. Edinger, L. Hall, Jr., and R. Morgan, II (Editors). Academic Press. New York, NY. 1980. pp. 183-205.

Empire State Electric Energy Research Corporation. "Alternative Fish Protective Techniques: Pneumatic Guns and Rope Nets." EP-83-12. March 1984.

Fay, R.R. Hearing in Invertebrates: A Psychophysics Data Book. Hill-Fay Associates. Winnetka, Illinois. 1988.

Frizzell, L.A., "Biological Effects of Acoustic Cavitation." In Ultrasound Its Chemical, Physical, and Biological Effects. K.S. Suslick (Editor). VCH Publishers, Inc. New York. 1988. pp. 287-319.

Haymes, G.T., and P.H. Patrick. "Exclusion of Adult Alewife (*Alosa pseudoharengus*), Using Low-Frequency Sound for Application of Water Intakes." Can. J. Fish. Aquatics Sci. 43:855-862. 1986.

Micheletti, Coal Combustion Systems Division. "Fish Protection at Cooling Water Intake Systems." EPRI Journal. September 1987.

Micheletti, Coal Combustion Systems Division. "Fish Protection at Cooling Water Intake Systems." EPRI Journal. September 1987.

Patrick, P.H., R.S. McKinley, A. E. Christie, and J.G. Holsapple. "Fish Protection: Sonic Deterrents." In the EPRI Proceedings: Fish Protection at Steam and Hydroelectric Power Plants. March 1988.

Platt, C., and A.N. Popper. "Find Structure and Function of the Ear." In Hearing and Sound Communication in Fishes. W.N. Tavolga, A.N. Popper and R.R. Ray (Editors). Springer-Verlag. New York.

Ross, Q.E., D. J. Dunning, R. Thorne, J. Menezes, G. W. Tiller, and J. K. Watson. Response of Alewives to High-Frequency Sound at a Power Plant Intake on Lake Ontario. 1993.

Schwarz, A.L., and G.L. Greer. "Responses of Pacific Herring, *Clupea harengus pallasii*, to Some Underwater Sounds." Can. J. Fish. Aquatic Sci. 41:1183-1192. 1984.

Smith, E.J., and J.K. Andersen. "Attempts to Alleviate Fish Losses from Allegheny Reservoir, Pennsylvania and New York, Using Acoustic." North American Journal of Fisheries Management, vol 4(3), 1984. pp. 300-307.

Thorne, R.E. "Assessment of Population Density by Hydroacoustics." In Journal of Biological Oceanography. Vol. 2. 1983. pp. 252-262.



New England Power Company. Effect of Ensonification on Juvenile American Shad Movement and Behavior at Vernon Hydroelectric Station, 1992. March 1993.

Patrick, P.H., R.S. McKinley, and W.C. Micheletti. "Field Testing of Behavioral Barriers for Cooling Water Intake Structures—Test Site 1—Pickering Nuclear Generating Station, 1985/86." In the Electric Power Research Institute Proceedings: Fish Protection at Steam and Hydroelectric Power Plants. March 1988.

Personal Communication, September 17, 1993, letter and enclosure from M.J. Curtin (Sonalysts, Inc.) to D. Benelmouffok (SAIC).

Ray, S.S., R.L. Snipes, and D. A Tomljanovich. "A State-of-the-Art Report on Intake Technologies." TVA PRS-16 and EPA 600/7-76-020. October 1976.

Sonalysts, Inc. "FishStartle System in Action: Acoustic Solutions to Environmental Problems" (on video tape). 215 Parkway North, Waterford, CT 06385.

Taft, E. P., and J.K. Downing. "Comparative Assessment of Fish Protection Alternatives for Fossil and Hydroelectric Facilities." In the Electric Power Research Institute Proceedings: Fish Protection at Steam and Hydroelectric Power Plants. March 1988.

Taft, E.P, J. K. Downing, and C. W. Sullivan. "Laboratory and Field Evaluations of Fish Protection Systems for Use at Hydroelectric Plants Study Update." In the Electric Power Research Institute's Proceedings: Fish Protection at Steam and Hydroelectric Power Plants. March 1988.

U.S. EPA. Development Document for Best Technology Available for the Location, Design, Construction, and Capacity of Cooling Water Intake Structures for Minimizing Adverse Environmental Impact. U.S. Environmental Protection Agency, Effluent Guidelines Division, Office of Water and Hazardous Materials. April 1976.

Uziel, Mary S., "Entrainment and Impingement at Cooling Water Intakes." Journal WPCF, Vol. 52, No.6. June 1980.

ADDITIONAL REFERENCES:

Blaxter, J.H.S., and D.E. Hoss. "Startle Response in Herring: the Effect of Sound Stimulus Frequency, Size of Fish and Selective Interference with the Acoustical-lateralis System." Journal of the Marine Biological Association of the United Kingdom. 61:871-879. 1981.

Blaxter, J.J.S., J.A.B. Gray, and E.J. Denton. "Sound and Startle Response in Herring Shoals." J. Mar. Biol. Ass. U.K. 61:851-869. 1981.

Burdic, W.S. Underwater Acoustic System Analysis. Englewood Cliffs, New Jersey: Prentice-Hall. 1984.

Burner, C.J., and H.L. Moore. "Attempts to Guide Small Fish with Underwater Sound." U.S. Fish and Wildlife Service. Special Scientific Report: Fisheries No. 403. 1962. p. 29.

3. INTAKE TECHNOLOGY REVIEW

A total of 25 intake technologies were identified in the literature as being appropriate to install at cooling water intake structures to minimize environmental impacts. Each technology was researched and reviewed to evaluate its application at cooling water intake structures and to assess its potential and efficacy to minimize adverse environmental impacts. The 25 intake technologies were classified as falling under one of three system categories. The technologies were identified as being: (1) an intake screen system, (2) a passive intake system, or (3) a fish diversion or avoidance system.

Table 3-1 presents technologies classified under each of the three categories. The general purpose of these technologies, in addition to the frequency of their use and performance, is summarized in the text below. Fact sheets supplying additional detail regarding each technology are provided in Appendix A. The fact sheets furnish information in the following areas: general technology description, testing facilities and/or facilities using the technology, research/operational findings, design considerations, advantages and limitations of using the technology, and supporting references. Additional references are also provided for some of the technologies. These additional references were not reviewed during this research effort because of time and budget constraints; however, these references should be considered for review at a later date so that the efficiency of the technologies is thoroughly evaluated.

3.1 Intake Screen Systems

The technologies classified as intake screen systems in Table 3-1 are mainly those devices that screen debris mechanically as compared to the passive intake systems where little or no mechanical activity is required. The intake screen systems category includes technologies currently in use at steam electric generating units. The system category also includes alternative screen technologies, which are not currently in use at U.S. steam electric facilities. Although the intake screen system technologies were not designed with fish protection in mind, they may provide a certain level of protection. They are, therefore, presented so that their use may be considered under subsequent Section 316(b) regulatory activities.

3.1.1 Summary of Findings: Intake Screen Systems

Single-Entry, Single-Exit Vertical Traveling Screens: These conventional traveling screens are the most widely used screening device for removal of debris. They are used by 60 percent of all the steam electric generating units in the United States (EEI, 1993). Their use is based on the collection and removal concept, high screenwell velocities, entrapment areas in the screenwell, and the handling of impinged fish as debris. These screens are most commonly associated with devices that cause entrainment and impingement impacts (Fritz, 1980). Some major United States steam electric power plants have experienced problems in debris handling when these screens have been used (Richards, 1988).

Modified Traveling Screens (Ristroph Screens): These are conventional traveling screens modified so that fish impinged on the screens can be removed with minimal stress and mortality. An essential feature of such screens is continuous operation during periods where fish are being

LIMITATIONS:

- The pneumatic air gun, hammer, and fishpulser are not considered reliable.
- Sophisticated acoustic sound generating systems require relatively expensive systems, including cameras, sound generating systems, and control systems. No cost information is available since a permanent system has yet to be installed.
- Sound barrier systems require site-specific designs consisting of relatively high technology equipment that must be maintained at the site.

REFERENCES:

- ASCE. Design of Water Intake Structures for Fish Protection. American Society of Civil Engineers. New York, NY. 1982. pp. 69-73.
- Chow, W., Ishwar P. Murarka, Robert W. Brocksen. Electric Power Research Institute, Entrainment and Impingement in Power Plant Cooling Systems. June 1981.
- Dunning, D.J., Q.E. Ross, P. Geoghegan, J.J. Reichle, J. K. Menezes, and J.K. Watson. Alewives Avoid High Frequency Sound. 1993.
- EPRI. Field Testing of Behavioral Barriers for Fish Exclusion at Cooling-Water Intake Systems: Central Hudson Gas and Electric Company, Roseton Generating Station. Electric Power Research Institute. September 1988.
- EPRI. Field Testing of Behavioral Barriers for Fish Exclusion at Cooling-Water Intake Systems: Ontario Hydro Pickering Nuclear Generating Station. Electric Power Research Institute. March 1989a.
- EPRI. Intake Research Facilities Manual. 1985. Prepared by Lawler, Matusky & Skelly Engineers, Pearl River, for Electric Power Research Institute. EPRI CS-3976. May 1985.
- EPRI. Intake Technologies: Research Status. Prepared by Lawler, Matusky & Skelly Engineers, Pearl River, for Electric Power Research Institute. EPRI GS-6293. March 1989.
- Hadderingh, R. H. "Fish Intake Mortality at Power Stations: The Problem and Its Remedy." Netherlands Hydrobiological Bulletin, 13(2-3), 83-93, 1979.
- Hanson, C. H., J.R. White, and H.W. Li. "Entrapment and Impingement of Fishes by Power Plant Cooling Water Intakes: An Overview." from Fisheries Review, MFR Paper 1266. October 1977.
- McKinley, R.S. and P.H. Patrick. "Use of Behavioral Stimuli to Divert Sockeye Salmon Smolts at the Seton Hydro-Electric Station, British Columbia." In the Electric Power Research Institute Proceedings: Fish Protection at Steam and Hydroelectric Power Plants. March 1988.
- Menezes, Stephen W. Dolat, Gary W. Tiller, and Peter J. Dolan. Sonalysts, Inc. Waterford, Connecticut. The Electronic FishStartle System. 1991.

**Table 3-1. Cooling Water Intake Technologies by System Category
(with corresponding fact sheet number)**

CATEGORY OF INTAKE CONTROL SYSTEM	FACT SHEET NO.	TYPE OF INTAKE CONTROL TECHNOLOGY
Intake Screen Systems	1	Single-Entry, Single-Exit Vertical Traveling Screens (Conventional)
	2	Modified Vertical Traveling Screens (Ristroph Screens)
	3	Inclined Single-Entry, Single-Exit Traveling Screens
	4	Single-Entry, Double-Exit Traveling Screens
	5	Double-Entry, Single-Exit Traveling Screens (Dual Flow)
	6	Horizontal Traveling Screens
	7	Fine Mesh Screens Mounted on Traveling Screens
	8	Horizontal Drum Screens
	9	Vertical Drum Screens
	10	Rotating Disk Screens
	11	Fixed Screens
Passive Intake Systems	12	Wedge-Wire Screens
	13	Perforated Pipes
	14	Radial Wells (Ranney Collectors)
	15	Porous Dikes
	16	Artificial Filter Beds
Fish Diversion or Avoidance Systems	17	Louver Barriers
	18	Velocity Cap
	19	Fish Barrier Nets
	20	Air Bubble Barriers
	21	Electrical Barriers
	22	Light Barriers
	23	Sound Barriers
	24	Cable and Chain Barriers
	25	Water Jet Curtains

- In fall 1992, the Sonalysts, Inc. FishStartle System was tested in a series of experiments conducted at the Vernon Hydroelectric plant on the Connecticut River. Caged juvenile shad were exposed to various acoustical signals to see which signals elicited the strongest reactions. Successful in situ tests involved applying the signals with a transducer system to divert juvenile shad from the forebay to a bypass pipe. Shad exhibited consistent avoidance reactions to the signals and did not show evidence of acclimation to the source (New England Power Company, 1993).

DESIGN CONSIDERATIONS:

- Sonalysts Inc. FishStartle system uses frequencies between 15 hertz to 130 kilohertz at sound pressure levels ranging from 130 to 206+ decibels referenced to one micropascal (dB//uPa). To develop a site-specific FishStartle program, a test program using frequencies in the low frequency portion of the spectrum between 25 and 3300 herz were used. Fish species tested by Sonalyst's, Inc. include white perch, striped bass, atlantic tomcod, spottail shiner, and golden shiner (Menezes et al., 1991).
- Sonalysts' FishStartle system used fixed programming contained on Erasable Programmable Read Only Memory (EPROM) micro circuitry. For field applications, a system was developed using IBM PC compatible software. Sonalysts' FishStartle system includes a power source, power amplifiers, computer controls and analyzer in a control room, all of which are connected to a noise hydrophone in the water. The system also uses a television monitor and camera controller that is linked to an underwater light and camera to count fish and evaluate their behavior.
- One Sonalysts, Inc. system has transducers placed 5 m from the bar rack of the intake.
- At the Seton Hydroelectric Station in British Columbia, the distance from the water intake to the fishpulser was 350 m (1150 ft); at Hells Gate, a fishpulser was installed at a distance of 500 feet from the intake.
- The pneumatic gun evaluated at the Roseton intake had a 16.4 cubic cm (1.0 cubic inch) chamber connected by a high pressure hose and pipe assembly to an Air Power Supply Model APS-F2-25 air compressor. The pressure used was a line pressure of 20.7 MPa (3000 psi) (EPRI, 1988).

ADVANTAGES:

- The pneumatic air gun, hammer, and fishpulser are easily implemented at low costs.
- Behavioral barriers do not require physical handling of the fish.

impinged compared to conventional traveling screens, which operate on an intermittent basis. Most of the impingement performance studies conducted for these screens at a number of steam electric power plants indicate a high initial survival rate for impinged fish (EPRI, 1989, Fritz, 1980). However, limited information was obtained during this research effort regarding the long-term survival of impinged fish on these screens. Since modified screens have been shown to lower fish impingement and mortality over conventional screens, the modified screens have been installed at several facilities as best available intake technology (EPRI, 1989). Eight currently operating, once-through steam electric generating units use this technology at their cooling water intakes (EEI, 1993).

Single-Entry, Single-Exit Inclined Traveling Screens: This technology uses conventional traveling screens but places them at an angle to the incoming flow. The angle placement improves the overall effectiveness of the screen since fish tend to avoid the screen's face. A fish bypass facility with independently induced flow must be provided with this technology to direct fish away from the intake device. Limitations include higher costs than the conventional traveling screen and a need for stable water elevation at the intake structure (ASCE, 1982).

Single-Entry, Double-Exit Vertical Traveling Screens: In this screen (also known as the Passavant screen), water enters the center of the screen and passes from the inside to the outside of the screening surface. The screen surface is theoretically double the size of a conventional, vertical traveling screen. This type of screen, which was developed in Europe almost 30 years ago, is currently in operation at only a few major U.S. steam electric plants. The velocity of flow entering between the screen faces is usually high, which leads to increased impingement and entrainment (Richards, 1988). Such screens can contribute to higher impingement because the required screen well can act as an entrapment device. From a fish protection standpoint, this screen does not offer any advantage over the single-entry, single-exit vertical traveling screen.

Double-Entry, Single-Exit Vertical Traveling Screens (Dual Flow Screens): In the double-entry, single-exit (dual flow) vertical traveling screens, water enters from both the ascending and descending sides of the screens and discharges from the downstream end between the faces while the upstream end is blocked off. The unit is turned so that the approach flow is parallel to the faces of the screen. Several utilities have recently completed installation, or are planning to install, dual flow screens because of their debris handling capabilities (EPRI, 1989). The performance evaluation of dual flow screens available from several in-plant studies does not indicate any real increase in impingement survival over conventional vertical traveling screens, especially when incorporated at an intake designed with low approach velocity (EPRI, 1989). Data from the EEI Power Statistics Database indicate that nine once-through steam electric generating units currently use this technology.

Horizontal Traveling Screens: Horizontal traveling screens are continuously moving screens that span the intake area in water source being screened. The screens rotate horizontally in the waterway with the upstream face placed at an angle to the flow. This placement guides fish in a manner similar to louvers and angled screen systems. Horizontal traveling screens form a complete physical barrier and have a high fish diversion efficiency in that they also release impinged fish into a bypass without passing the air-water interface. However, the requirement of continuous operation, at much higher speeds than the conventional vertical traveling screens, has created mechanical problems that have not yet been resolved (ASCE, 1982). Because of this

TESTING FACILITIES AND/OR FACILITIES WITH TECHNOLOGY IN USE:

- No fishpulsers and pneumatic air guns are currently in use at water intakes.
- Research facilities that have recently completed studies or have on-going testing involving fishpulsers or pneumatic air guns include Consumers Power Company at Ludington pumped storage site on Lake Michigan; Nova Scotia Power; the Hells Gate Hydroelectric Station on the Black River; Southern California Edison Company at Santa Cruz Harbor on the Pacific Ocean; the Annapolis Generating Station on the Bay of Fundy; Ontario Hydro's Pickering Nuclear Generating station; the Roseton Generating Station, the Central Hudson Gas and Electric Company; Seton Hydroelectric Station, British Columbia; Empire State Electric Energy Research Corporation; LTV Corporation (Cleveland Steel Works) on the Cuyahoga River in Ohio; Surry Power Plant in Virginia; New York Power Authority's Indian Point Nuclear Generating Station Unit 3; and the U.S. Army Corps of Engineers on the Savannah River (EPRI, 1985; EPRI, 1989; EPRI, 1988; and Taft, et al., 1988).
- Updated acoustic technology developed by Sonalysts, Inc. has been applied at the James A. Fitzpatrick Nuclear Power Plant in New York on Lake Ontario; the Boston Harbor in Massachusetts; the Vernon Hydroelectric plant on the Connecticut River (New England Power Company, 1993; Menezes, et al., 1991; personal communication with Sonalysts, Inc., by SAIC, 1993); and in a quarry in Verplank, New York (Dunning, et al., 1993).

RESEARCH/OPERATION FINDINGS:

- Most pre-1976 research was related to fish response to sound rather than on field applications of sound barriers (EPA, 1976; Ray et al., 1976; Uziel, 1980; Hanson, et al., 1977).
- Before 1986, no acoustic barriers were deemed reliable for field use. Since 1986, several facilities have tried to use pneumatic poppers with limited successes. Even in combination with light barriers and air bubble barriers, poppers and fishpulsers were ineffective for most intakes (Taft and Downing, 1988; EPRI, 1985; Patrick, et al., 1988; EPRI, 1989; EPRI, 1988; Taft, et al., 1988; McKinley and Patrick, 1988; Chow, 1981).
- A 1991 full-scale 4-month demonstration at the James A. FitzPatrick (JAF) Nuclear Power Plant in New York on Lake Ontario showed that the Sonalysts, Inc. FishStartle System reduced alewife impingement by 87 percent as compared to a control power plant located 1 mile away. (Ross, et al., 1993; Menezes, et al., 1991). JAF experienced a 96 percent reduction compared to fish impingement when the acoustic system was not in use. A 1993 3-month test of the system at JAF was reported to be successful (Menezes et al., 1991; SAIC personal communication with M. Curtin of Sonalysts, Inc.), but details of the study are not yet published.
- During marine construction of Boston's third Harbor Tunnel in 1992, the Sonalysts, Inc. FishStartle System was used to prevent shad, blueback herring, and alewives from entering underwater blasting areas during the fishes' annual spring migration. The portable system was used prior to each blast to temporarily deter fish and allow periods of blasting as necessary for the construction of the tunnel (personal communication to SAIC from M. Curtin, Sonalysts, Inc., September 17, 1993).

operational limitation, the screens are not currently manufactured. Application of this type of screen to a large industrial intake would require extensive and costly research (EPA, 1976).

Fine Mesh Screens Mounted on Traveling Screens: Fine mesh screens mounted on traveling screens are used to exclude eggs, larvae, and juvenile forms of fish from intakes. These screens rely on gentle impingement of organisms on the screen surface or retention of larvae within the screens. The success of an installation using fine mesh screens is contingent on the application of satisfactory handling and recovery facilities to allow the safe return of impinged organisms to the aquatic environment (Pagano et al., 1977; Sharma, 1978). In situ studies on the use of fine mesh on conventional traveling screens and modified traveling screens have indicated that these mesh screens reduce entrainment. However, these screens have not been demonstrated to be effective for reducing mortality or entrainment losses (EPRI, 1989).

Horizontal Drum Screens: Horizontal drum screens, which are widely used outside the United States, are screens placed on large revolving wheels. The screens are placed with their longitudinal axes horizontal across the intake channel. They are considered more efficient in debris removal and more reliable than conventional traveling screens. The main advantages of drum screens are their simplicity, fewer moving parts than in conventional traveling screens, their ease of maintenance, and the elimination of any possibility of debris carryover. The main disadvantage of horizontal drum screens is their capital cost. The screens themselves are usually less costly than the conventional traveling screens, but the cost of the screen structures is much larger. The total differential costs are \$821,000 (1982 dollars) in favor of the conventional traveling screens (Richards, 1988). Drum screens are not currently used at U.S. steam electric plants. There is little evidence to indicate that these screens offer any fish protection advantage over the conventional traveling screens (ASCE, 1982).

Vertical Drum Screens: The vertical revolving drum screen technology consists of a screen placed on a vertical revolving drum, which is located across an intake opening in front of the pumps. This arrangement operates well under conditions of fluctuating water levels. Vertical drum screens are not used at U.S. power plants. They have been used for fish diversion in irrigation canals and in British steam electric stations for protection of salmonids with variable success (Eicher, 1974). Since larger types have not been developed, their reliability is unknown (ASCE, 1982).

Rotating Disk Screen: The face of the rotating disk is covered by mesh at right angles to the water channel. The disk rotates around a horizontal axis, bringing the dirty screen face above water where high pressure sprays wash the debris into a trough. This screen is only suitable for relatively small flows and small water level variations. The rotating disk screen is not currently used at U.S. steam electric plants. This device has a minimum number of moving parts and, thus, is inexpensive to buy and maintain. However, the high probability of fish impingement, the need of high pressure sprays to remove fish and debris, and the need of very large screen structures to limit screen approach velocities make it unattractive for use at cooling water intakes. Such a screen has no advantage over other common screens from a fish protection point of view (EPA, 1976; ASCE, 1982).

Fixed Screens: The most common type of fixed screen is the vertically installed device placed in front of the intake pumps. The screens, generally mounted in a frame, are installed

**FISH DIVERSION OR AVOIDANCE
SYSTEMS**

FACT SHEET NO. 23

SOUND BARRIERS

DESCRIPTION:

Sound barriers are non-contact barriers that rely on mechanical or electronic equipment that generates various sound patterns to elicit avoidance responses in fish. Acoustic barriers are used to deter fish from entering industrial water intakes and power plant turbines. Historically, the most widely-used acoustical barrier is a pneumatic air gun or "popper." The pneumatic air gun is a modified seismic device which produces high-amplitude, low-frequency sounds to exclude fish. Closely related devices include "fishdrones" and "fishpulsers" (also called "hammers"). The fishdrone produces a wider range of sound frequencies and amplitudes than the popper. The fishpulser produces a repetitive sharp hammering sound of low-frequency and high-amplitude. Both instruments have limited effectiveness in the field (EPRI, 1985; EPRI, 1989; Hanson, et al., 1977; EPA, 1976; Taft, et al., 1988; ASCE, 1982).

Prior to 1986, researchers were unable to demonstrate or apply acoustic barriers as fish deterrents, even though fish studies showed that fish respond to sound, because the response varies as a function of fish species, age, and size as well as environmental factors at specific locations. Fish may also acclimate to the sound patterns used (EPA, 1976; Taft et al., 1988; EPRI, 1985; Ray et al., 1976; Haddingh, 1979; Hanson et al., 1977; ASCE, 1982).

Since about 1989, the application of highly refined sound generation equipment originally developed for military use (e.g., sonar in submarines) has greatly advanced acoustic barrier technology. This technology has the ability to generate a wide array of frequencies, patterns, and volumes, which are monitored and controlled by computer. Video and computer monitoring provide immediate feedback on the effectiveness of an experimental sound pattern at a given location. In a particular environment, background sounds can be accounted for, target fish species or fish populations can quickly be characterized, and the most effective sound pattern can be selected (Menezes, et al., 1991; Sonalysts, Inc.).

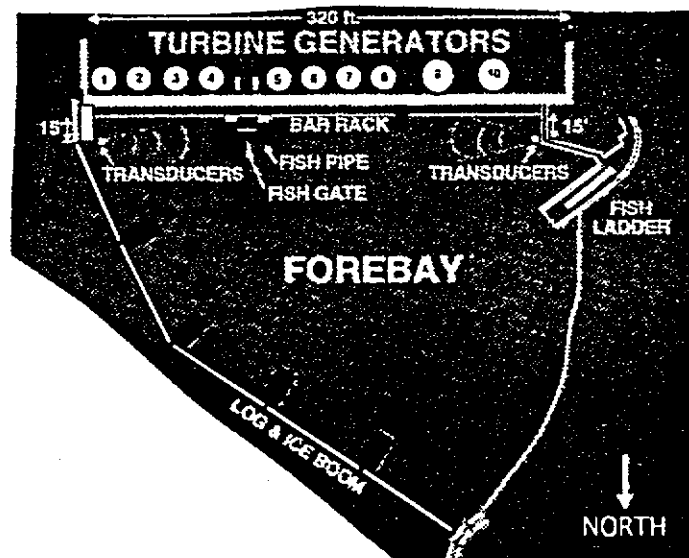

Electronic FishStartle Component Locations

in vertical tracks on the intake channel walls and are usually lifted out of the water for cleaning. Their use is limited to intake locations where suspended debris is negligible. Most of the fixed screens are installed at small steam electric plants. The major limitations of these screens are that operators must be available at all times to maintain the screens. Long impingement times between cleaning periods may result in total mortality of fish. Data from the EEI Power Statistics Database indicate that 13 once-through steam electric units and 31 closed-cycle steam electric units currently in operation in the United States use this technology.

3.1.2 Conclusions: Intake Screen Systems

The main finding with regard to intake screen systems is that they are limited in their abilities to minimize adverse aquatic impact. In fact, conventional traveling screens (the most widely used screening device at U.S. steam electric plants) and most of the other types of traveling screens have been installed mainly for their debris handling capabilities. In addition, the conventional traveling screens have not even been proved to be reliable for the removal of debris at U.S. steam electric plant intakes. In fact, many major U.S. steam electric plants experience problems as pointed out by Richards (1988): *"... and many of our major power plants have been in serious trouble because of cooling water conditions which our U.S. screening system cannot cope. This is becoming more apparent today when special efforts are being made to improve plant performance, rather than build new plants."* In other words, the need of any alternative technology to replace the conventional vertical traveling screen will be dictated by economic reasons and not by a necessity for aquatic life protection. The Electric Power Research Institute (EPRI) recently stated that very little work is being conducted or sponsored by utilities to mitigate entrainment and/or impingement at cooling water intake structures. This reflects the condition that most generating stations are in compliance with biological conditions contained in their operating permits (EPRI, 1989).

The steam electric industry has examined mitigation measures to minimize the environmental impact at cooling water structures and has mainly concentrated on the modification of conventional through-flow traveling screens so that fish that are impinged on the screens can be removed with minimal stress and mortality. These modified traveling screens have been shown to be effective at lowering fish impingement and mortality over conventional screens at several locations and have been installed as the best available technology at several locations. There has also been an interest in the use of fine mesh mounted on traveling screens for the minimization of entrainment. However, the use of fine mesh mounted on conventional traveling screens has not been demonstrated as an effective technology for reducing mortality or entrainment losses (EPRI, 1989).

Finally, even though site-specific studies have reported impact mitigation using alternative screen technologies, a review of these technologies, in general, indicates that, from an aquatic protection standpoint, the technologies are not any more efficient than the conventional, through-flow traveling screens. In addition, the amount of reduction attributable to any of these devices has been found to be site- and species-specific (Richards, 1988; EPRI, 1989; Uziel, 1980).

**FISH DIVERSION OR AVOIDANCE
SYSTEMS**

FACT SHEET NO. 23

SOUND BARRIERS

DESCRIPTION:

Sound barriers are non-contact barriers that rely on mechanical or electronic equipment that generates various sound patterns to elicit avoidance responses in fish. Acoustic barriers are used to deter fish from entering industrial water intakes and power plant turbines.

Historically, the most widely-used acoustical barrier is a pneumatic air gun or "popper." The pneumatic air gun is a modified seismic device which produces high-amplitude, low-frequency sounds to exclude fish. Closely related devices include "fishdrones" and "fishpulsers" (also called "hammers"). The fishdrone produces a wider range of sound frequencies and amplitudes than the popper. The fishpulsar produces a repetitive sharp hammering sound of low-frequency and high-amplitude. Both instruments have limited effectiveness in the field (EPRI, 1985; EPRI, 1989; Hanson, et al., 1977; EPA, 1976; Taft, et al., 1988; ASCE, 1982).

Prior to 1986, researchers were unable to demonstrate or apply acoustic barriers as fish deterrents, even though fish studies showed that fish respond to sound, because the response varies as a function of fish species, age, and size as well as environmental factors at specific locations. Fish may also acclimate to the sound patterns used (EPA, 1976; Taft et al., 1988; EPRI, 1985; Ray et al., 1976; Haddingh, 1979; Hanson et al., 1977; ASCE, 1982).

Since about 1989, the application of highly refined sound generation equipment originally developed for military use (e.g., sonar in submarines) has greatly advanced acoustic barrier technology. This technology has the ability to generate a wide array of frequencies, patterns, and volumes, which are monitored and controlled by computer. Video and computer monitoring provide immediate feedback on the effectiveness of an experimental sound pattern at a given location. In a particular environment, background sounds can be accounted for, target fish species or fish populations can quickly be characterized, and the most effective sound pattern can be selected (Menezes, et al., 1991; Sonalysts, Inc.).

TESTING FACILITIES AND/OR FACILITIES WITH TECHNOLOGY IN USE:

- No fishpulsers and pneumatic air guns are currently in use at water intakes.
- Research facilities that have recently completed studies or have on-going testing involving fishpulsers or pneumatic air guns include Consumers Power Company at Ludington pumped storage site on Lake Michigan; Nova Scotia Power; the Hells Gate Hydroelectric Station on the Black River; Southern California Edison Company at Santa Cruz Harbor on the Pacific Ocean; the Annapolis Generating Station on the Bay of Fundy; Ontario Hydro's Pickering Nuclear Generating station; the Roseton Generating Station, the Central Hudson Gas and Electric Company; Seton Hydroelectric Station, British Columbia; Empire State Electric Energy Research Corporation; LTV Corporation (Cleveland Steel Works) on the Cuyahoga River in Ohio; Surry Power Plant in Virginia; New York Power Authority's Indian Point Nuclear Generating Station Unit 3; and the U.S. Army Corps of Engineers on the Savannah River (EPRI, 1985; EPRI, 1989; EPRI, 1988; and Taft, et al., 1988).

3.2 Passive Intake Systems (Physical Exclusion Devices)

Passive intake systems are those devices that screen-out debris and biota with little or no mechanical activity required. Most of these systems are based on achieving very low withdrawal velocities at the screening media so that organisms will avoid the intake. Highlights of the important elements for each passive intake device are summarized below.

3.2.1 Summary of Findings: Passive Intake Systems

Wedge-Wire Screens: Wedge-wire screens are mainly designed to reduce entrainment of fish eggs and larvae by physical exclusion and by exploiting hydrodynamics. Physical exclusion occurs when the mesh size of the screen is smaller than the organisms susceptible to entrainment. Hydrodynamic exclusion results from maintenance of a low, through-slot velocity which, because of the screen's cylindrical configuration, is quickly dissipated, thereby allowing organisms to escape the flow field. In situ and laboratory studies have shown that impingement is virtually eliminated and that entrainment is considerably reduced when wedge-wire screens are used (Hanson, 1978; Weisberg et al., 1984; Heuer and Tomljanovitch, 1978; Lifton, 1979; Delmarva Power and Light, 1982; and Weisberg et al., 1983). This device also offers some advantage in debris removal (Richards, 1988). However, it is presently limited to relatively small flow withdrawals such as make-up water for closed-cycle cooling systems. Data from the EEI Power Statistics Database indicate that a total of five closed-cycle steam electric generating units use wedge-wire screens at their intake structure (EEI, 1993).

Perforated Pipes: Perforated pipes draw water through slots in a cylindrical section placed in the waterway. The term "perforated" is applied to round perforations and elongated slots. Clogging, frazil ice formation, biofouling and removal of debris limits this technology to small flow withdrawals. These devices have been used at locations requiring small amounts of water such as make-up water. However, experience at steam electric plants is very limited (Sharma, 1978).

Radial Wells: Radial wells are developed in the same manner as conventional wells. This intake consists of a vertical pump caisson, which is sunk below the water table near the surface water body (e.g., river). Several perforated collector screen pipes (radial wells) are then jacked out through wall ports into the surrounding porous aquifer. Radial well intakes, long represented by the Ranney Collector, have a long history of successful performance and offer maximum protection to aquatic organisms of all sizes. (EPA, 1976; ASCE, 1982). One main limitation is that radial wells are only suitable where there is a porous aquifer. This consideration, and the associated costs of pumps and a large piping network, currently limit the radial wells for once-through application (Mussalli et al. 1980). Data from the EEI Power Statistics Database indicate that two closed-cycle steam electric generating units in the United States currently use radial wells (EEI, 1993).

Porous Dikes: Porous dikes are filters resembling a breakwater surrounding a cooling water intake. The core of the dike consists of cobble or gravel, which permits free passage of water. The dike acts both as a physical and behavioral barrier to aquatic organisms. Tests conducted to date have indicated that the technology is effective in excluding juvenile and adult fish. The major problems associated with porous dikes come from clogging by debris and silt,

Hadderingh, R. H. "Fish Intake Mortality at Power Stations: the Problem and Its Remedy." Netherlands Hydrobiological Bulletin, 13(2-3), 83-93. 1979.

McKinley, R.S. and P.H. Patrick. "Use of Behavioral Stimuli to Divert Sockeye Salmon Smolts at the Seton Hydro-Electric Station, British Columbia" from the Electric Power Research Institute. Proceedings: Fish Protection at Steam and Hydroelectric Power Plants. March 1988.

Patrick, P.H., R.S. McKinley, and W.C. Micheletti. "Field Testing of Behavioral Barriers for Cooling Water Intake Structures—Test Site 1—Pickering Nuclear Generating Station, 1985/86," in EPRI Proceedings: Fish Protection at Steam and Hydroelectric Power Plants. March 1988.

Ray, S.S., R.L. Snipes, and D. A Tomljanovich, "A State-of-The-Art Report on Intake Technologies," TVA PRS-16 and EPA 600/7-76-020. October 1976.

Taft, E.P, J. K. Downing, and C. W. Sullivan. "Laboratory and Field Evaluations of Fish Protection Systems for Use at Hydroelectric Plants: Study Update." in EPRI Proceedings: Fish Protection at Steam and Hydroelectric Power Plants. March 1988.

U.S. EPA. Development Document for Best Technology Available for Location, Design, Construction and Capacity of Cooling Water Intake Structures for Minimizing Adverse Environmental Impacts. EPA 440/1-76/015-a. 1976.

ADDITIONAL REFERENCES:

Haymes, G.T., P.H. Patrick, and L.J. Onisto. "Attraction of Fish to Mercury Vapour Light and Its Application in a Generating Station Forebay." Int. Revue Ges. Hydrobiological. 69:867-876. 1984.

Hocutt, C.H. "Behavioral Barriers and Guidance Systems." In Power Plants: Effects on Fish and Shellfish Behavior, C.H. Hocutt, J.R. Stauffer, Jr., J. Edinger, L. Hall, Jr., and R. Morgan, II (Editors). New York, NY. Academic Press. 1980. pp. 183-205.

McIninch, S.P., and C.H. Hocutt. "Effects of Turbidity on Estuarine Fish Response to Strobe Lights." Journal of Applied Ichthyology, Vol. 3. 1987. pp. 97-105.

Patrick, P.H. Responses of Alewife and Gizzard Shad to Flashing Light. Toronto, Canada: Ontario Hydro Research Division. February 1983. 82-442-k.

Patrick, P.H., A.E. Christie, D. Sager, C. Hocutt, and J. Stauffer, Jr. "Responses of Fish to a Strobe Light/Air Bubble Barrier." Fisheries Research, 3:157-172. 1985.

Patrick, P.H., and G.L. Vascotto. "Response of Fish to Light." In Proceedings of the Workshop of Advanced Intake Technology. 1981. pp. 252-260.

Sager, D.R., C.H. Hocutt, and J.R. Stauffer, Jr. "Estuarine Fish Responses to Strobe Light, Bubble Curtains, and Strobe Light/Bubble-Curtain Combinations as Influenced by Water Flow Rate and Flash Frequencies." Fisheries Research, Vol. 5, 1987. pp. 383-399.

ice build-up and frazil ice, and fouling by colonization of fish and plant life. The porous dike technology is still being developed, and its use is actually limited to small flow intakes. Data from the EEI Power Statistics Database indicate that two once-through steam electric generating units in the United States currently use this technology (EEI, 1993).

Artificial Filter Beds: Artificial filter beds utilize a prepared granular filter material to prevent entrance of debris and aquatic life into a water withdrawal facility. Artificial filter beds can only be sited on water bodies that have low concentrations of suspended particles and where potential for clogging and biofouling is low. Although this technology or concept has high screening potential, operational difficulties and limited intake capacity characteristics have discouraged any further research and development for use at steam electric power plant intakes (Richards, 1978; ASCE, 1982).

Nearshore Marine Filter Beds: A modified sea water intake filtration system has been patented by Elarbash Systems of Libya and M&S Systems International of Malta. This system has been used, thus far, to provide uncontaminated water to large-scale desalinization facilities in the Middle East. General performance data provided by the manufacturer indicate that the system does not entrain or impinge aquatic organisms. The system uses physically and chemically stable non-biodegradable materials for its filtering system. The system is buried 5 to 10 meters from the shoreline and is covered with 10 to 90 centimeters of site sand. The system reportedly uses wave motion to prevent clogging and does not require backwash or routine maintenance. The system is constructed in modular form and can be constructed to meet widely varying flow demands (Elarbash, 1991b). Many details regarding construction and performance were unavailable because of proprietary constraints. Because of the limited information available, a fact sheet was not developed for this technology.

3.2.2 Conclusions: Passive Intake Systems

The main findings for passive intake systems are that available technologies that effectively reduce fish eggs and larvae entrainment are extremely limited. In fact, from all of the passive intake system technologies reviewed, only the radial wells (Ranney Collectors) offer an effective protection to aquatic organisms of all sizes and provide a degree of screening that far exceeds the requirements for cooling water supplies. However, their major limitation is that the radial wells are only suitable where there is a porous aquifer. The other limitation is that for larger cooling water intakes, the cost of radial wells is considerably greater than that required for a conventional intake.

The other alternative that appears to offer a potentially effective means of reducing fish losses is the wedge-wire screen. Testing of wedge-wire screens has demonstrated that fish impingement is virtually eliminated and that entrainment of fish eggs and larvae is reduced. However, limitations due to the physical size of the screening device restrict the application of wedge-wire screens to closed-cycle make-up or other small flows.

Testing of porous dikes has revealed that this technology is effective in excluding juvenile and adult fish. The major problems associated with porous dikes are clogging by debris and silt, ice build-up and frazil ice, and fouling by colonization of fish and plant life. The technology of the porous dikes is still being developed, and its use is actually limited to small flow intakes.

- At the Ludington pumped storage station on Lake Michigan, the lights in combination with a fishpulsar (acoustic device) had no effect on fish deterrence (EPRI 1987). At Consumers Power Company, a study showed that strobe lights were generally more effective than a fishpulsar. Other data on the effectiveness of a combination of behavioral barriers were generally inconsistent.

DESIGN CONSIDERATIONS:

- Light barriers are inexpensive to design, operate, and maintain. However, the species distribution and fish response at a particular location must be evaluated in a pilot demonstration to select the optimum design.
- The study at Horn Laboratory evaluated the effect of turbidity and velocity on fish response to strobe lights. The lights elicited a response in 8 to 100 percent of the white perch, spot, and Atlantic menhaden with greatest effects found at flash rates of 300/min and lower flow rates. Turbidity also affected the strobe light effectiveness with the lowest avoidance (9 percent) in clear water and highest avoidance (81 percent) in turbid water.

ADVANTAGES:

- Light barrier systems are inexpensive to install, operate, and maintain compared to the total cost of a steam electric power plant.
- Behavioral barriers do not require physical handling of the fish.

LIMITATIONS:

- Compared to mechanical fish barriers, light is still generally considered a relatively ineffective fish barrier.

REFERENCES:

ASCE. Design of Water Intake Structures for Fish Protection. American Society of Civil Engineers. 1982. pp. 69-73.

EPRI. Field Testing of Behavioral Barriers for Fish Exclusion at Cooling-Water Intake Systems: Central Hudson Gas and Electric Company, Roseton Generating Station. Electric Power Research Institute. September 1988.

EPRI. Field Testing of Behavioral Barriers for Fish Exclusion at Cooling-Water Intake Systems: Ontario Hydro Pickering Nuclear Generating Station. Electric Power Research Institute. March 1989a.

EPRI. Intake Research Facilities Manual. Prepared by Lawler, Matusky and Skelly Engineers and Ontario Hydro for Electric Power Research Institute. 1985.

EPRI. Intake Technologies. Electric Power Research Institute. March 1989.

Light Barriers: Light barriers consist of controlled application of strobe lights or mercury vapor lights to lure fish away from cooling water intakes or to deflect their natural migration patterns. This technology is based on research that has shown that some fish avoid light. However, because it is known that some species are attracted by light, it is generally accepted that the effectiveness of light barriers is species-dependent. Although this is an inexpensive technology to install, the species distribution and fish response at a particular location must be evaluated in a pilot demonstration to select the optimum design. Apparently, no light barriers are currently in use as fish deterrents at cooling water intakes. Several facilities have tested the technology and, although the results are inconsistent, the general consensus is that light barriers are ineffective in deterring fish from entering cooling water intakes.

Sound Barriers: Sound barriers are non-contact barriers that rely on mechanical or electronic equipment to generate various sound patterns to deter fish from entering industrial water intakes and power plant turbines. Although sound barriers as fish deterrents have been extensively researched, this technology is not currently in use at existing U.S. cooling water intakes. Several types of sound barriers have been developed and tested, including the pneumatic air gun or "popper", which is a modified seismic device that produces high amplitude, low frequency sounds to exclude fish. Closely related devices include "fishdrones" and "fishpulsers" (also called "hammers"). The fishdrone produces a wider range of sound frequencies and amplitudes than the popper. The fishpulser produces a repetitive sharp hammering sound of low frequency and high amplitude. In general, however, studies have shown that these instruments have limited effectiveness in the field.

A recent development, the "Fishstartle System," is an acoustical fish barrier developed by Sonalysts, Inc. This device depends on sophisticated sound patterns generated on a site-specific basis for target fish species. Several research projects indicate that the Fishstartle System may be a viable technology to reduce entrainment and impingement of fish at cooling water intakes.

Cable and Chain Barriers: This technology consists of barriers of cables or chains that are suspended vertically across the front of a cooling water intake. These systems are designed to take advantage of fish behavior, that is, of fish tendency to avoid objects moving through water (Ray et al., 1976). Conclusions of most of the testing conducted to date indicate that cable and chain barriers show little promise as a technology for diverting fish at cooling water intakes. No facilities in the EEI Power Statistics Database reported using cable and chain barriers.

Water Jet Curtains: Water jet curtains typically consist of a row of vertical pipes, fitted with evenly spaced jet nozzles, that are then placed in front of a cooling water intake. The jets produce a curtain of high pressure water, which is intended to deter fish from entering the intake area. Water jet curtains have not been used in many actual applications to date. Testing has not revealed the efficiency of the technology to be appropriate for use alone to divert fish from cooling water intakes. However, the technology may be used in conjunction with other technologies to provide an efficient fish diversion system. No facilities in the EEI Power Statistics Database reported using water jet curtains.

**FISH DIVERSION OR AVOIDANCE
SYSTEMS**

FACT SHEET NO. 22

LIGHT BARRIERS

DESCRIPTION:

Light barriers consist of controlled application of strobe lights or mercury vapor lights to guide fish away from cooling water intakes or deflect their natural migration patterns. Researchers have noted that light is very important to visual orientation of fish. However, the response to light barriers is species dependent; some fish are attracted to light while others avoid it. Therefore, the use of light barriers has generally not proved successful (Hadderingh, 1979; ASCE, 1982, EPA 1976; EPRI, 1985; EPRI, 1989; McKinley and Patrick, 1988; Ray et al., 1976).

TESTING FACILITIES AND/OR FACILITIES USING THE TECHNOLOGY:

- Available literature indicated that no light barriers are currently in use, but several facilities have tested the technology.
- Test sites include Ontario Hydro's Pickering Nuclear Generating Station (Patrick, et al., 1988; EPRI, 1989a); the Central Hudson Gas and Electric Roseton Station (EPRI, 1988); Seton Hydroelectric Station in British Columbia; Consumers Power Company; the Holyoke Dam and Canal on the Connecticut River; the Ludington pumped storage station on Lake Michigan; the Wanapum Dam on the Columbia River; Wapatox Canal Fish Screening Facility on the Naches River; the University of Iowa and the University of Washington; the York Haven Dam, Susquehanna River; the Horn Point Laboratory; and Lakeside Engineering (EPRI, 1987; EPRI, 1989; McKinley and Patrick, 1988; Taft, et al., 1988).

RESEARCH/OPERATION FINDINGS:

- Statistical data on fish barrier studies show that results are inconsistent at best. Most researchers found that the light barriers are ineffective in deterring fish from entering water intakes (Hadderingh, 1979; ASCE, 1982; EPA 1976; EPRI, 1985; EPRI, 1989; McKinley and Patrick, 1988; Ray et al., 1976).
- EPRI 1987 data show that strobe lights may be more effective as fish barriers than mercury lights. However, it is generally accepted that the effectiveness of light barriers is species dependent (ASCE, 1982; Hadderingh, 1979; EPRI, 1985; EPRI, 1989).
- At Consumers Power Company, Ludington pumped storage station, Wapatox Canal, University of Washington, and University of Iowa (EPRI reports dated 1987 and 1989), fish were attracted to mercury lights. However, other data showed that mercury lights elicited no response in fish or repelled them (at York Haven Dam on the Susquehanna River, from EPRI 1989).
- Data from the Wapatox Canal showed no difference in results for studies conducted at night versus daytime.

Louvered 360° Radial Intake: A modified intake structure has been developed by Elarbash Systems of Libya and M&S Systems International of Malta; this systems is reportedly "virtually invisible to suspended matter, fish and seafloor sand." This system utilizes a 360 degree radial intake structure that provides equipotential intake velocity increases as water approaches the structure. The intake structure also incorporates a louver system within the intake head to guide fish to a return flow conduit (Elarbash, 1991a). Because of the proprietary nature of the system, detailed construction and performance data were not available; thus a fact sheet was not developed.

3.3.2 Conclusions: Fish Diversion and/or Avoidance Systems

The main finding relative to fish diversion and/or avoidance systems is that none of the corresponding technologies protect organisms and/or fish that are non-motile or in early life stages. In addition, because fish diversion and avoidance devices rely on the behavioral characteristics of fish, the effectiveness and performance of the devices is species-specific. Therefore, site-specific testing is required in most cases where these devices are to be used. As a result, modification of the technology to be used may be required.

Many of the fish diversion and avoidance devices are appropriate for seasonal entrainment problems in that they provide flexibility to be used during certain times of the year. For example, barrier nets may be put in place during certain times of the year when fish are migrating past the intake structure.

Louvers and velocity caps have been proved effective in diverting fish away from intakes at numerous facilities. Velocity caps are used almost exclusively for offshore intake facilities. Louvers are often used in conjunction with other intake technologies such as screens and fish handling devices. Water jet curtains and cable and chain barriers have not been as successful as the other technologies.

Barrier nets and electrical barriers are effective with certain applications. Electrical barriers are effective for upstream migrating fish. If such fish are stunned by the electric shock, they are carried away from the intake. Electrical barriers, however, are not appropriate for downstream migrating fish. If such fish are stunned, they are carried with the flow into the intake. Barrier nets are effective if the fish to be diverted are of similar size.

Air bubble barriers, light barriers, and conventional sound barrier technologies have limitations as effective fish diversion and avoidance devices. Field applications of air bubble barriers have generally been unsuccessful and inconsistent. Light barriers have proved to be ineffective in some cases because these devices actually attract certain species of fish; some sound barrier technologies have demonstrated limited success in the field because some species acclimate to the sound patterns.

Pugh, J.R. "Effect of Certain Electrical Parameters and Water Resistivities on Mortality of Fingerling Silver Salmon." U.S. Fish Wildl. Serv. Fish Bull. 62. 1962. p. 223-234.

Pugh, J.R., G.E. Monan, and J.R. Smith. "Effect of Water Velocity on the Fish Guiding Effectiveness of an Electric Field." Fish-Passage Res. Prog. U.S. Bur. Commer. Fish. Seattle, Wash. Review of Progress, Vol. III. 1964. p. 6.

Stone and Webster Engineering Corp. "First Progress Report Indian Point Flume Study." Consolidated Edison Company Report. New York, NY. 1975.

Texas Utilities Generating Co. "Intake Systems." In Commanche Peake Steam Electric Station Environmental Report Operating License Stage. TX Util. Gen. Co. Report. Dallas, TX. 1979.

Trefethen, P.S. "Exploratory Experiments in Guiding Salmon Fingerlings by a Narrow D.C. Electric Field." U.S. Fish Wildl. Serv. Spec. Sci. Rep. 158. 1955. p. 425.

Van Drevelt, T., and J.F. De Bakker. "Electrical Fish Barriers of the Maas Power Plant at Buggenum." Electrotechniek 40. 1962. p. 257-276.

Vibert, R. "Applications of Electricity of Inland Fishery Biology and Management. In R. Vibert (Editor), Fishing with Electricity. Published for F.A.O. by Fishing News (Books) Ltd. London. 1967. 276p.

- Hanson, B.N., W.H. Bason, B.E. Beitz and K.E. Charles. "A Practical Intake Screen Which Substantially Reduces the Entrainment and Impingement of Early Life Stages of Fish." In Fourth National Workshop on Entrainment and Impingement, L.D. Jensen (Editor). Ecological Analysts, Inc., Melville, NY. Chicago, December 1977, pp 393-407.
- Heuer, J.H., and D.A. Tomljanovitch. "A Study on the Protection of Fish Larvae at Water Intakes Using Wedge-Wire Screening." In Larval Exclusion Systems For Power Plant Cooling Water Intakes. R.K. Sharmer and J.B. Palmer (Editors). Argonne National Lab., Argonne, IL. February 1978, pp. 169-194.
- Lifton, W.S. "Biological Aspects of Screen Testing on the St. Johns River, Palatka, Florida." In Passive Screen Intake Workshop, Johnson Division UOP Inc., St. Paul, MN. 1979.
- Marley Cooling Tower Company. Personal Communication with Pricing Representative. Mission, KS. February 23, 1994.
- Mussalli, Y.G., E.P. Taft III, and J. Larsen. "Offshore Water Intakes Designated to Protect Fish." In Journal of the Hydraulics Division, Proceedings of the America Society of Civil Engineers. Vol. 106, No Hy11, November 1980, pp. 1885-1901.
- Pagano R., and W.H.B. Smith. Recent Developments in Techniques to Protect Aquatic Organisms at the Intakes Steam-Electric Power Plants. MITRE Technical Report 7671. November 1977.
- Ray, S.S., R.L. Snipes, and D.A. Tomljanovich. A State-of-the-Art Report on Intake Technologies. Prepared for Office of Energy, Minerals, and Industry, Office of Research and Development. U.S. Environmental Protection Agency, Washington, D.C. by the Tennessee Valley Authority. EPA 600/7-76-020. October 1976.
- Richards, R.T. "Present Engineering Limitations to the Protection of Fish at Water Intakes." In Fourth National Workshop on Entrainment and Impingement. L.D. Jensen (Editor). Ecological Analysts, Inc., Melville, NY. Chicago, December 1977. pp. 415-424.
- Richards, R.T. Alternative Water Screening for Thermal Power Plants. ASCE Journal of Hydraulics Engineering, Vol 114, No. 6, June 1988, pp. 578-597.
- Sharma, R.K., "A Synthesis of Views Presented at the Workshop." In Larval Exclusion Systems For Power Plant Cooling Water Intakes. San Diego, CA, February 1978, pp. 235-237.
- Stanford, William. Cooling Towers: Principles and Practice: A Practical Guide to Cooling Tower Selection and Operation, 2nd Edition. Birmingham, AL, Carter Thermal Engineering, Ltd., 1970.
- USDOC. 1982 Census of Manufactures -- Volume 1. U.S. Department of Commerce, Bureau of the Census. 1983.

REFERENCES:

ASCE. Design of Water Intake Structures for Fish Protection. American Society of Civil Engineers. 1982.

EPRI. Intake Research Facilities Manual. Prepared by Lawler, Matusky & Skelly Engineers, Pearl River, for Electric Power Research Institute. EPRI CS-3976. May 1985.

EPRI. Intake Technologies: Research Status. Prepared by Lawler, Matusky & Skelly Engineers, Pearl River, for Electric Power Research Institute. EPRI GS-6293. March 1989.

Haddingth, R.H. "Fish Intake Mortality at Power Stations, the Problem and Its Remedy." N.V. Kema, Arnheem, Netherlands. Hydrological Bulletin 13(2-3) (1979): 83-93.

Hanson, C.H., et al. "Entrapment and Impingement of Fishes by Power Plant Cooling Water Intakes: An Overview." Marine Fisheries Review. October 1977.

Ray, S.S., R.L. Snipes, and D.A. Tomljanovich. A State-of-the-Art Report on Intake Technologies. Prepared for Office of Energy, Minerals, and Industry, Office of Research and Development. U.S. Environmental Protection Agency, Washington, D.C. by the Tennessee Valley Authority. EPA 600/7-76-020. October 1976.

U.S. EPA. Development Document for Best Technology Available for the Location, Design, Construction, and Capacity of Cooling Water Intake Structures for Minimizing Adverse Environmental Impact. U.S. Environmental Protection Agency, Effluent Guidelines Division, Office of Water and Hazardous Materials. April 1976.

ADDITIONAL REFERENCES:

Applegate, V.C., P.T. Macy, and V.E. Harris. "Selected Bibliography on the Applications of Electricity in Fishery Science." U.S. Fish Wildlife Service, Sec. Sci. Rep. Fish. 127 (1954): 55p.

Bates, D.W. The Horizontal Traveling Screen. In F.L. Parker and P.A. Krenkel (Editors), Engineering Aspects of Thermal Pollution. Vanderbilt University Press. Nashville, TN. 1969.

Elliot, F.E. "On the Status of Electric Fishing." J. Mar. Technol. Soc. 4. 1970. p. 58-60.

Holmes, H.B. "History, Development, and Problems of Electric Fish Screens." U.S. Fish Wildl. Serv. Spec. Sci. Rep. 53. 1948. p. 62.

Hyman, A.M., W.H. Mowbray, and S.B. Sails. The Effects of Two Electrical Barriers on the Entrapment of Fish at a Freshwater Nuclear Power Plant. Symposium by Fisheries and Energy Production. 1974.

Maxwell, W.A. "Fish Diversion for Electrical Generating Station Cooling Systems a State-of-the-Art Report." Southern Nuclear Engineering, Inc. Report SNE-123. NUS Corporation. Dunedin, FL. 1973. 78p.

USEPA. Development Document for Best Technology Available for the Location, Design, Construction, and Capacity of Cooling Water Intake Structures for Minimizing Adverse Environmental Impact. U.S. Environmental Protection Agency, Effluent Guidelines Division, Office of Water and Hazardous Materials. April 1976.

USEPA. Development Document for Proposed Best Technology Available for Minimizing Adverse Environmental Impact of Cooling Water Intake Structures. U.S. Environmental Protection Agency, Effluent Guidelines Division, Office of Water and Hazardous Materials. 1973.

Uziel, Mary S. "Entrainment and Impingement at Cooling Water Intakes." Literature Review. Journal Water Pollution Control Federation. 52 (6) (1980): 1616-1630.

Weisberg, S.B., F. Jacobs, W.H. Burton, and R.N. Ross. Report on Preliminary Studies Using the Wedge Wire Screen Model Intake Facility. Prepared for State of Maryland, Power Plant Siting Program. Prepared by Martin Marietta Environmental Center, Baltimore, MD, 1983.

Weisberg, S.B., W.H. Burton, E.A. Ross, and F. Jacobs. The Effects of Screen Slot Size, Screen Diameter, and Through-Slot Velocity on Entrainment of Estuarine Ichthyoplankton Through Wedge-Wire Screens. Martin Marietta Environmental Studies, Columbia MD, August 1984.

- Pulse duration
- Conductivity of the water.

The following range of design information was taken from available information on actual operating conditions at several plants and testing facilities in the Pacific Northwest, Idaho, California, Indiana, and New York (EPA, 1976):

- Source voltages from 60 to 900 volts
- Pulse frequencies of 1 to 10 pulses per second or continuous
- Pulse durations of 10 to 50 milliseconds
- Series of electrodes 18 to 36 inches apart
- Use of parallel rows 12 to 20 inches apart.

Species to be diverted in these studies included salmon fingerlings, squawfish, perch and mixed populations. Diversion efficiencies are reported from 68 to 82 percent at these facilities.

ADVANTAGES:

- Electrical barriers have the flexibility to be applied intermittently. This is appropriate for intakes that have the potential to entrain fish that are migratory or are only in the area during certain seasons.
- Electrical barriers may be appropriate where relatively few species and sizes of fish are present at the intake (Ray et al., 1976).

LIMITATIONS:

- Conductivity values in waters (especially estuarine and marine) may vary greatly over time because of flows and tidal changes that may require adjustments to maintain the desired polarity (EPA, 1976; Ray et al., 1976).
- The barriers have not been shown to be effective with the downstream movement of fish.
- In deterring fish from downstream intakes, fish may tire and be swept through the barrier and become entrained (ASCE, 1982; Ray et al., 1976).
- Electrical barriers have not been shown to be effective with fish migrating or traveling downstream.
- Electrical barriers are not appropriate for intakes where there are mixtures of fish sizes and species because of the site-specific variability of effective voltages.
- Electrical barriers are not appropriate for intakes sited in estuarine or marine waters because of the low electrical resistance of these water types (Hanson, 1977).
- Electrical screens may pose a threat to humans.
- Electrical barriers may cause adverse environmental impacts for other species of fish or other animals passing through the area because of the species-specific voltages used.



TESTING FACILITIES AND/OR FACILITIES USING THE TECHNOLOGY:

- The Millstone Nuclear Power Station in Waterford, Connecticut, tested electrical barriers from 1973 to 1975, and the Pickering Generating Station in Ontario tested them from 1976 to 1977 (EPRI, 1985). The literature cites additional studies performed in the Pacific Northwest and Idaho and the use of this technology at intakes in Indiana (Northern Indiana Public Service Company's Michigan City Plant), Connecticut (CT Yankee Atomic Power Plant), and New York (EPA, 1976; Ray et al., 1976).
- The U.S. Fish and Wildlife Service tested electric barriers for a period of 15 years until 1965 to screen and divert upstream migrant fish (EPA, 1976). Facilities abroad with electrical barriers in use include one in the Soviet Union and two Dutch facilities: the Amer Power Station at Geertruidenberg and the Maas Power Station at Buggenum.
- The Dutch State Institute for Fishery Research (RIVO) has been testing fish behavior in electric fields since 1978 (Haddinger, 1979). The Holyoke dam and canal on the Connecticut River is reported to have tested electrical barriers in the summer and fall of 1987 to modify the downstream movement of adult and juvenile American Shad (EPRI, 1989).

RESEARCH/OPERATION FINDINGS:

- Pulsed current has been found to be most effective for fish guidance and diversion and for power requirements (Hanson, 1977).
- Behavioral responses vary among species and size of fish. Therefore, the required voltage, pulse frequency, and duration differ for individual fish (Hanson, 1977; EPA, 1976).
- Guidance efficiencies of 68 percent have been reported in large-scale laboratory experiments using fingerling salmon. Guidance efficiency for salmonid was found to decrease as the water velocity increased above 15 centimeters per second (cm/sec) (Trefethen, 1955, in Hanson, 1977).
- Adult salmon migrating upstream respond to the barrier by jumping violently back after entering the electric field and retreating several feet downstream. After attempting to pass the barrier several times and sustaining shocks, the fish then approach more slowly and typically follow the line of the electric field to a fish bypass or handling device. If the fish are stunned by the electricity, they are carried away from the intake by the current (EPA, 1976).

DESIGN CONSIDERATIONS:

Important design considerations presented in the available literature for electrical barriers include the following:

- Spacing of electrodes
- Voltage applied
- Pulse frequency

INTAKE SCREENING SYSTEMS

SINGLE-ENTRY, SINGLE-EXIT
VERTICAL TRAVELING SCREENS
(CONVENTIONAL TRAVELING SCREENS)

DESCRIPTION:

The single-entry, single-exit vertical traveling screens (conventional traveling screens) consist of screen panels mounted on an endless belt; the belt rotates through the water vertically. The screen mechanism consists of the screen, the drive mechanism, and the spray cleaning system. Most conventional traveling screens are fitted with 3/8 inch mesh, which screens out and prevents debris from clogging the pump and the condenser tubes. The screen mesh is usually supplied in individual removable panels referred to as "baskets" or "trays."

The screen washing system consists of a line of spray nozzles operating at a relatively high pressure of 80 to 120 pounds per square inch (psi). The screens typically rotate at a single speed. The screens are rotated either at predetermined intervals or when a predetermined differential pressure is reached across the screens, based on the amount of debris in the intake waters.

Because of the intermittent operation of the conventional traveling screens, fish can become impinged against the screens and eventually die during the extended period of time while the screens are stationary. When the screens are rotated, the fish are removed from the water and subjected to a high pressure spray; during this process, the fish may fall back into the water and become reimpinged or damaged (EPA, 1976; Pagano et al., 1977).

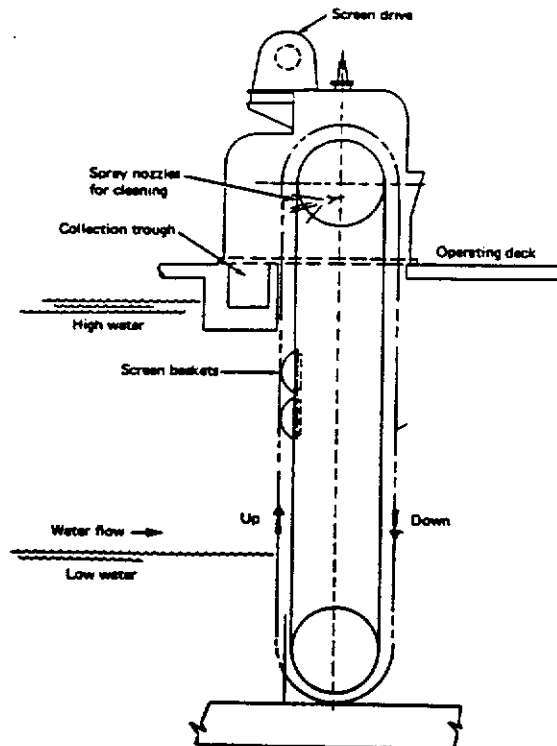

Conventional Traveling Screen (EPA, 1976)

**FISH DIVERSION OR AVOIDANCE
SYSTEMS**

FACT SHEET NO. 21

ELECTRICAL BARRIERS

DESCRIPTION:

Electrical barriers (sometimes called "electric screens") consist of a series of immersed electrodes and ground wires that generate an electric field (see figure below). As the fish pass into the electric field, a voltage difference occurs through their body between the head and the tail creating a flight reaction in the fish (Haddingh, 1979). The electric barrier may consist of a graduated electrical field created by successive pairs of electrodes with progressively high voltage. An alternative configuration may have two rows of alternate electrodes (ASCE, 1982).

Existing information on the study and use of electrical barriers indicates that, in general, electrical barriers do not provide the performance, consistency, or reliability that is needed in diverting fish and other organisms away from cooling water intake structures. In most cases, electrical barriers have been abandoned as a viable fish diversion option.

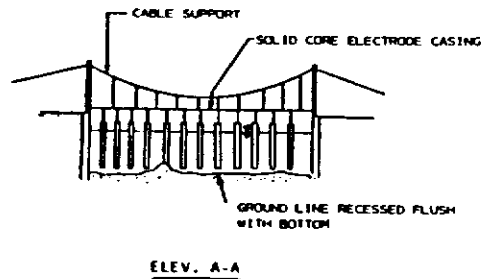
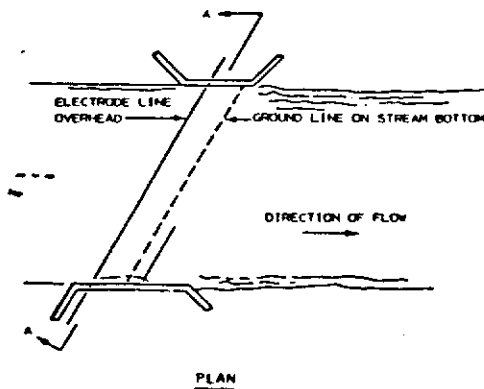

Electrical Barrier Configuration (EPA, 1976)

TESTING FACILITIES AND/OR FACILITIES USING THE TECHNOLOGY:

- The conventional traveling screens are the most common screening device currently used at steam electric power plants. Sixty percent of all facilities use this technology at their intake structures (EEI, 1993).

RESEARCH/OPERATION FINDINGS:

- The conventional single-entry single screen is the most widely-used screening technology among steam electric power plants (Fritz, 1980).

DESIGN CONSIDERATIONS:

- The screens are designed to withstand a differential pressure across their face of 4 to 8 feet of water.
- The recommended maximum water velocity through the screen is about 2.5 feet per second (ft/sec). At or below this velocity, fish entrainment and impingement are negligible (ASCE, 1982).
- The screens normally travel at one speed (10 to 12 feet per minute) or two speeds (2.5 to 3 feet per minute and 10 to 12 feet per minute). These speeds can be increased to handle heavy debris loads.

ADVANTAGES:

- Conventional traveling screens are a proven off-the-shelf technology that is readily available.

LIMITATIONS:

- Impingement is a major problem of the conventional traveling screen technology.

REFERENCES:

ASCE. Design of Water Intake Structures for Fish Protection. American Society of Civil Engineers. New York, NY. 1982.

EEI Power Statistics Database. Prepared by the Utility Data Institute for the Edison Electric Institute. Washington, DC. 1993.

Fritz, E.S. Cooling Water Intake Screening Devices Used to Reduce Entrainment and Impingement. Topical Briefs: Fish and Wildlife Resources and Electric Power Generation, No. 9. 1980.

Pagano R., and W.H.B. Smith. Recent Developments in Techniques to Protect Aquatic Organisms at the Water Intakes of Steam-Electric Power Plants. Prepared for Electricite de France. MITRE Technical Report 7671. November 1977.

Electric Power Research Institute. Field Testing of Behavioral Barriers for Fish Exclusion at Cooling-Water Intake Systems: Ontario Hydro Pickering Nuclear Generating Station. March 1989a.

Electric Power Research Institute (EPRI). Intake Research Facilities Manual. Prepared by Lawler, Matusky and Skelly Engineers and Ontario Hydro. 1985.

Electric Power Research Institute (EPRI). Intake Technologies. March 1989.

Haddingh, R. H. "Fish Intake Mortality at Power Stations: the Problem and Its Remedy." Netherlands Hydrobiological Bulletin, 13(2-3), 83-93. 1979.

Patrick, P.H., R.S. McKinley, and W.C. Micheletti. Field Testing of Behavioral Barriers for Cooling Water Intake Structures—Test Site 1—Pickering Nuclear Generating Station. 1985/86.

Ray, S.S., R.L. Snipes, and D. A Tomljanovich. "A State-of-The-Art Report on Intake Technologies." TVA PRS-16 and EPA 600/7-76-020. October 1976.

U.S. EPA. Development Document for Best Technology Available for Location, Design, Construction and Capacity of Cooling Water Intake Structures for Minimizing Adverse Environmental Impacts. EPA 440/1-76/015-a. 1976.

ADDITIONAL REFERENCES:

Bibko, P.N., L. Wirtenan, and P.E. Jueser. "Preliminary Studies on the Effects of Air Bubbles and Intense Illumination on the Swimming Behavior of the Striped Bass (*Morone saxatilis*)." Second Workshop on Entrainment and Intake Screening. Johns Hopkins University. 1974, pp. 293-304.

Grotbeck, L.M. "Evaluation of an Air Curtain as a Fish Deterrent Device at the Prairie Island Nuclear Generating Plant Cooling Water Intake." Northern States Power (NSP), 1975 Annual Report, Environmental Monitoring and Ecological Studies Program, Prairie Island Nuclear Generating Plant, Vol. II. 1975. pp 2.8-1 to 2.8-25.

Hocutt, C.H. "Behavioral Barriers and Guidance Systems." In Power Plants: Effects on Fish and Shellfish Behavior, C.H. Hocutt, J.R. Stauffer, Jr., J. Edinger, L. Hall, Jr., and R. Morgan, II (eds.). New York, NY. Academic Press. 1980. pp. 183-205.

Patrick, P.H., A.E. Christie, D. Sager, C. Hocutt, and J. Stauffer, Jr. "Responses of Fish to a Strobe Light/Air Bubble Barrier." Fisheries Research, 3:157-172. 1985.

Sager, D.R., C.H. Hocutt, and J.R. Stauffer, Jr. "Estuarine Fish Responses to Strobe Light, Bubble Curtains, and Strobe Light/Bubble-Curtain Combinations as Influenced by Water Flow Rate and Flash Frequencies." Fisheries Research, Vol. 5. 1987. pp. 383-399.

U.S. EPA. Development Document for Best Technology Available for the Location, Design, Construction, and Capacity of Cooling Water Intake Structures for Minimizing Adverse Environmental Impact. U.S. Environmental Protection Agency, Effluent Guidelines Division, Office of Water and Hazardous Materials. April 1976.

DESIGN CONSIDERATIONS:

- Bubble curtains must extend all the way to the bottom of the water column to prevent fish from passing through gaps in and around the barrier.
- Most test systems are designed with spacing between bubble outlets of 1 to 5 inches. Installation and location requirements for the systems are site-specific.
- An example design from the Pickering Generating Station in Ontario includes paired control and test structures located 78 meters offshore at the end of the intake canal. Each structure is 9 meters wide and extends about 6 meters through the entire water column.
- The air bubble curtain at Central Hudson Gas and Electric's Roseton Generating Station was assembled using a Bio-Weve diffuser hose manufactured by Schramm, Inc. The air bubble curtain is made up of 15-foot sections of hose made of 5.7 cm. (2.25 in.) flexible woven polyester fiber hose surrounded by rigid polyethylene (0.95 cm, 0.38 in). Pellets between the inner distributor and outer diffuser provide weight to limit lateral diffusion and counteract buoyancy. The bubble size is 0.16 cm (0.06 in.) in diameter or smaller. The hose sections employed in the Roseton air bubble curtain required approximately 7.6 cubic meters per minute (270 cubic feet per minute) of air. Two compressors were used to allow greater control of the air flow (EPRI, 1988).

ADVANTAGES:

- Bubble curtains are relatively easy to design and install at low cost.
- Behavioral barriers do not require physical handling of fish.

LIMITATIONS:

- Field applications of air bubble curtains have generally been unsuccessful, and results have been inconsistent (EPRI, 1989; EPRI, 1985; Chow et al., 1981; ASCE, 1982; Hadderingh, 1979).
- Each system must be designed to fit a site-specific intake structure.

REFERENCES:

ASCE. Design of Water Intake Structures for Fish Protection. American Society of Civil Engineers (ASCE). pp. 69-73. 1982.

Chow, W., Ishwar P Murarka, Robert W. Brocksen. "Electric Power Research Institute, Entrainment and Impingement in Power Plant Cooling Systems." Journal of the Water Pollution Control Federation, Volume 53, Number 6. June 1981.

Electric Power Research Institute. Field Testing of Behavioral Barriers for Fish Exclusion at Cooling-Water Intake Systems: Central Hudson Gas and Electric Company, Roseton Generating Station. September 1988.

INTAKE SCREENING SYSTEMS

FACT SHEET NO. 2

MODIFIED VERTICAL TRAVELING SCREENS

DESCRIPTION:

Modified vertical traveling screens are conventional traveling screens fitted with a collection "bucket" beneath the screen panel. This intake screening system is also called a bucket screen, Ristroph screen, or a Surry Type screen. The screens are modified to achieve maximum recovery of impinged fish by maintaining them in water while they are lifted to a release point. The buckets run along the entire width of the screen panels and retain water while in upward motion. At the uppermost point of travel, water drains from the bucket but impinged organisms and debris are retained in the screen panel by a deflector plate. Two material removal systems are provided. The first uses low-pressure spray that gently washes fish into a recovery trough. The second system uses the typical high-pressure spray that blasts debris into a second trough. An essential feature of this screening device is its continuous operation, which keeps impingement times relatively short (Richards, 1977; Mussalli, 1977; Pagano et al., 1977; EPA, 1976).

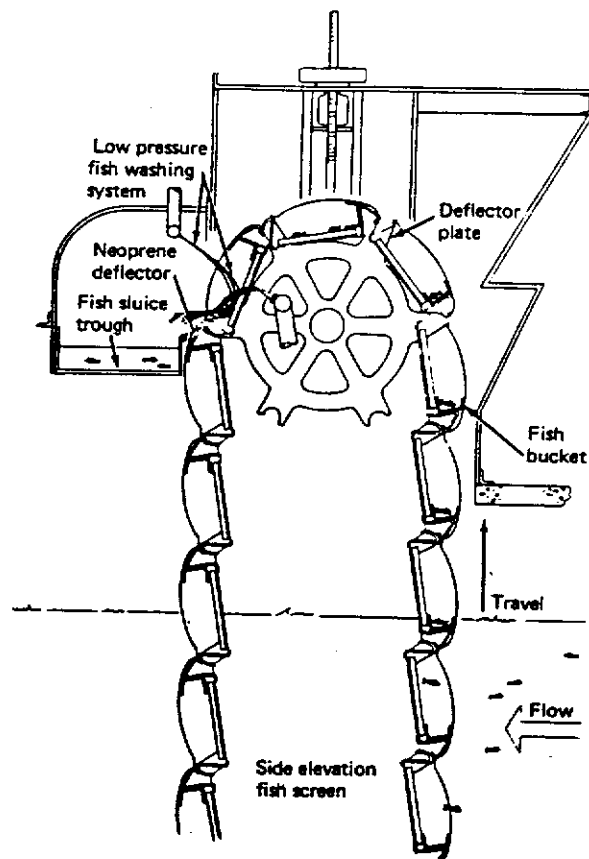

Modified Vertical Traveling Screens (White et al., 1976)

TESTING FACILITIES AND/OR FACILITIES USING THE TECHNOLOGY:

- Air bubble barriers have been evaluated at the Pickering Nuclear Generating Station (1985-1986) in Ontario, Canada; the Seton Hydroelectric facility in British Columbia (1986), the Nanticoke Thermal Generating Station in Ontario, Canada; the Millstone Nuclear Power Station on Long Island Sound in Connecticut; the Monroe Power plant in Michigan; the Quad-Cities Commonwealth Edison Company on the Mississippi River Power Plant; the Prairie Island Nuclear Generating Station in Minnesota; the Michigan City plant in Indiana; the Indian Point Generating Station in New York; the Kewaunee Nuclear Plant on Lake Michigan, and the J.P. Pulliam plants in Wisconsin (ASCE, 1982; Ray et al., 1976).
- Testing of air bubble barriers in conjunction with other behavior barriers was performed in 1986-1987 at the Central Hudson Gas and Electric's Roseton Generating Station in New York (EPRI, 1988) and the Pickering Nuclear Generating Station (EPRI, 1989a; Patrick, et al., 1988).
- Laboratory testing was performed at the University of Maryland's Horn Point Laboratory using varying water velocities and turbidity levels on estuarine species (EPRI 1985 and EPRI 1986).
- It is not known whether any facilities are currently using this technology.

RESEARCH/OPERATION FINDINGS:

- Although not currently considered a reliable fish deterrent barrier, air bubble barriers have achieved limited success. In general, the barrier is more effective with schools of fish than with individuals.
- Air bubble barrier effectiveness depends largely on the temporal and spacial variability of the dominant species near the intake structures.
- Other factors that influence effectiveness include water temperature, light intensity, and water velocity (ASCE, 1982; EPRI, 1989; EPRI, 1989a; EPRI, 1988; EPRI 1985; Chow et al., 1981; ASCE, 1982; Hadderingh, 1979; Ray, et al., 1976).
- Horn Laboratory (U. of Maryland) found air bubble barriers ineffective in deterring all taxa during daytime or night, in high or low turbidity (low turbidity at 39 to 45 NTU and high turbidity at 102-138 NTU), or at various temperatures (EPRI, 1989).
- Combining air bubble barriers with lights and/or pneumatic guns also showed limited success. At the Pickering Nuclear Generating Station (1985-1986) and the Central Hudson Gas and Electric's Roseton Generating Station (1986-87), the combination of these technologies was ineffective (EPRI, 1989). In combination with lights, species-specific air bubble barrier successes were noted at Horn Point Laboratory (EPRI, 1989).
- Nanticoke results of tests conducted with alewife, rainbow smelt, and gizzard shad were not published (EPRI, 1985).

TESTING FACILITIES AND/OR FACILITIES USING THE TECHNOLOGY:

Facilities that have tested the screens include Virginia Electric Power Company's Surry Power Station (White et al., 1976) (the screens have been in operation since 1974); Dairyland Power Cooperative's Madgett Generating Station in Alma, Wisconsin; Consolidated Edison Company of New York's Indian Point Nuclear Generating Station Unit 2; New York State and Electric Company's Somerset Generating Station (the screens are fitted with 1 millimeter (mm) mesh); the Orange and Rockland Utility's Bowline Point Generating Station (King et al., 1977); the Central Hudson Gas and Electric Corporation's Roseton and Danskammer Generating Stations (King et al., 1977); and the Hanford Generating Plant on the Columbia River (Page et al., 1975; Fritz, 1980).

RESEARCH/OPERATION FINDINGS:

Modified traveling screens have been shown to have good potential for alleviating impingement mortality (EPRI, 1989). However, limited information is available on long-term survival of impinged fish (ASCE, 1982; Fritz, 1980). Specific research and operation findings are listed below:

- Modified traveling screens were installed and evaluated for mechanical reliability and post-impingement survival at Consolidated Edison Company of New York's Indian Point Nuclear Generating Station Unit 2. The survival rate for the top three fish species (96 percent of the total) was 62.9 percent for white perch, 60.2 percent for striped bass, and 92 percent for rainbow smelt (EPRI, 1989).
- New York State and Electric Company is evaluating, at its Somerset Generating Station, the fish survival from Ristroph screens fitted with 1 mm mesh. Two underwater cameras have been installed to evaluate the fish return system. The results of field testing are not yet available (EPRI, 1989).
- One of the few studies that did provide evidence for long-term survival was conducted at the Hanford Generating Plant on the Columbia River (Page et al., 1975; Fritz, 1980). In this study, 79 to 95 percent of the impinged and collected chinook salmon fry survived for over 96 hours.

DESIGN CONSIDERATIONS:

- The screens are designed to withstand a differential pressure across their face of 4 to 8 feet of water.
- The recommended maximum water velocity through the screen is about 2.5 feet per second (ft/sec). At or below this velocity, fish entrainment and impingement are negligible (ASCE, 1982).
- The screens normally travel at one speed (10 to 12 feet per minute) or two speeds (2.5 to 3 feet per minute and 10 to 12 feet per minute). These speeds can be increased to handle heavy debris loads.

**FISH DIVERSION OR AVOIDANCE
SYSTEMS**

FACT SHEET NO. 20

AIR BUBBLE BARRIERS

DESCRIPTION:

Air bubble barriers (sometimes called "air curtains" or "bubble screens") consist of an air header with jets arranged to provide a continuous curtain of air bubbles over a cross sectional area. The general purpose of air bubble barriers is to repel schools of fish that may attempt to pass through the barrier. Field applications of air bubble barriers have generally been unsuccessful and usually inconsistent. Current research indicates that bubble screening is not considered a reliable fish deterrent system (EPRI, 1989; EPRI, 1985; Chow et al., 1981; ASCE, 1982; Haddingh, 1979).

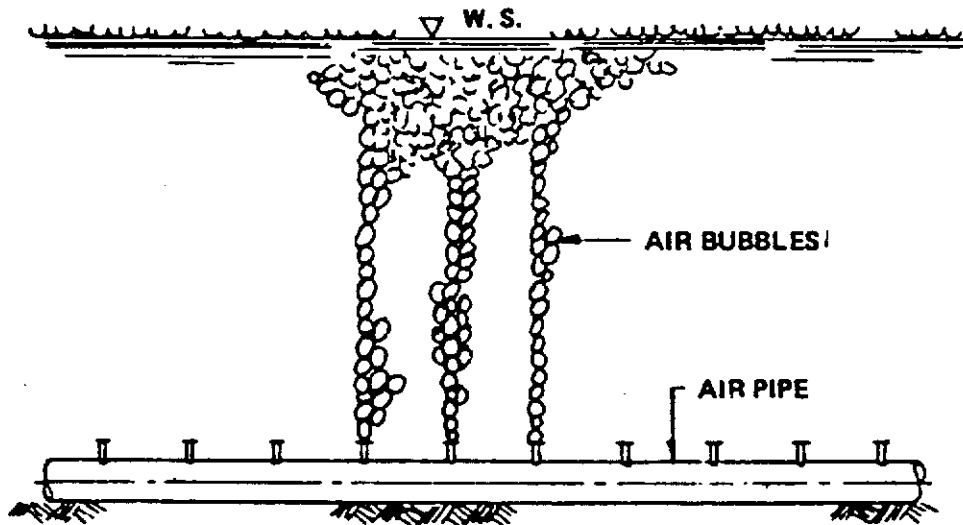

Air Bubble Curtains (EPA, 1976)

ADVANTAGES:

- Traveling screens are a proven off-the-shelf technology that is readily available. An essential feature of such screens is continuous operation during periods where fish are being impinged compared to conventional traveling screens, which operate on an intermittent basis.

LIMITATIONS:

- Continuous operation has resulted in undesirable maintenance problems (Mussalli, 1977).
- Velocity distribution across the face of the screen is generally very poor.

REFERENCES:

ASCE. Design of Water Intake Structures for Fish Protection. American Society of Civil Engineers. New York, NY. 1982.

EPRI. Intake Technologies: Research Status. Electric Power Research Institute GS-6293. March 1989.

Fritz, E.S. Cooling Water Intake Screening Devices Used to Reduce Entrainment and Impingement. Topical Briefs: Fish and Wildlife Resources and Electric Power Generation, No. 9. 1980.

King, L.R., J.B. Hutchinson, Jr., T.G. Huggins. "Impingement Survival Studies on White Perch, Striped Bass, and Atlantic Tomcod at Three Hudson Power Plants." In Fourth National Workshop on Entrainment and Impingement. L.D. Jensen (Editor) Ecological Analysts, Inc., Melville, NY. Chicago, IL. December 1977.

Mussalli, Y.G. "Engineering Implications of New Fish Screening Concepts." In Fourth National Workshop on Entrainment and Impingement. L.D. Jensen (Editor). Ecological Analysts, Inc., Melville, NY. Chicago, IL. December 1977. pp 367-376.

Pagano, R., and W.H.B. Smith. Recent Developments in Techniques to Protect Aquatic Organisms at the Intakes Steam-Electric Power Plants. MITRE Technical Report 7671. November 1977.

Page, T.L., R.H. Gray, and E.G. Wolf. Report on Impingement Studies Conducted at the Hanford Generating Project—March and April 1976. Report to Washington Public Power Supply System. Battelle - Northwest, Richland, WA. 1976.

Richards, R.T. "Present Engineering Limitations to the Protection of Fish at Water Intakes." In Fourth National Workshop on Entrainment and Impingement. L.D. Jensen (Editor). Ecological Analysts, Inc., Melville, N.Y. Chicago, IL. December 1977. pp. 415-424.

White, J.C., and M.L. Brehmer. "Eighteen-Month Evaluation of the Ristroph Traveling Fish Screens." In Third National Workshop on Entrainment and Impingement. L.D. Jensen (Editor). Ecological Analysts, Inc. Melville, NY. 1976.

ADVANTAGES:

- Net barriers, if operating properly, should require very little maintenance.
- Net barriers have relatively little cost associated with them.

LIMITATIONS:

- Net barriers are not effective for the protection of the early life stages of fish or zooplankton (ASCE, 1982).

REFERENCES:

ASCE. Design of Water Intake Structures for Fish Protection. American Society of Civil Engineers. New York, NY. 1982.

EPRI. Intake Research Facilities Manual. Prepared by Lawler, Matusky & Skelly Engineers, Pearl River, for Electric Power Research Institute. EPRI CS-3976. May 1985.

Lawler, Matusky, and Skelly Engineers. 1977 Hudson River Aquatic Ecology Studies at the Bowline Point Generating Stations. Prepared for Orange and Rockland Utilities, Inc. Pearl River, NY. 1978.

U.S. EPA. Development Document for Best Technology Available for the Location, Design, Construction, and Capacity of Cooling Water Intake Structures for Minimizing Adverse Environmental Impact. U.S. Environmental Protection Agency, Effluent Guidelines Division, Office of Water and Hazardous Materials. April 1976.

TESTING FACILITIES AND/OR FACILITIES USING THE TECHNOLOGY:

- The Commonwealth Edison Company in New York is reported to make extensive use of barrier nets to mitigate impingement (EPRI, 1989). The Orange and Rockland Utility's Bowline Point Generating Station, the Wisconsin Public Service Corporation's J.P. Pullium Power Plant in Green Bay, and the Nantioke Thermal Generating Station in Ontario also use barrier nets.
- Barrier Nets have been tested at the Detroit Edison Monroe Plant on Lake Erie and the Chalk Point Station on the Patuxent River in Maryland (ASCE, 1982; EPRI, 1985). The Maryland station now uses barrier nets seasonally to reduce fish and Blue Crab entry into the intake canal (EPRI, 1985). The Pickering Generation Station in Ontario evaluated rope nets in 1981 illuminated by strobe lights (EPRI, 1985).

RESEARCH/OPERATION FINDINGS:

- At the Bowline Point Generating Station in New York, good results have been realized with a net placed in a V arrangement around the intake structure (ASCE, 1982).
- Impingement at a Wisconsin plant has been reduced by as much as 90 percent using a barrier net (ASCE, 1985).
- Nets tested with high intake velocities (greater than 1.3 feet per second) at the Monroe Plant have clogged and subsequently collapsed. This has not occurred at facilities where the velocities are 0.4 to 0.5 feet per second (ASCE, 1982).
- Barrier nets at the Nantioke Thermal Generating Station in Ontario reduced intake of fish by 50 percent (EPRI, 1985).
- The J.P. Pullium Generating Station in Wisconsin uses dual barrier nets (0.64 centimeters stretch mesh) to permit net rotation for cleaning. Nets are used from April to December or when water temperatures go above 4 degrees Celsius. Impingement has been reduced by as much as 90 percent. Operating costs run about \$5,000 per year, and nets are replaced every 2 years at \$2,500 per net (EPRI, 1985).
- The Chalk Point Station in Maryland realized operational costs of \$5,000 to \$10,000 per year with the nets being replaced every 2 years (EPRI, 1985).

DESIGN CONSIDERATIONS:

- The most important factors to consider in the design of a net barrier are the site-specific velocities and the potential for clogging with debris (ASCE, 1982).
- The size of the mesh must permit effective operations, without excessive clogging. Designs at the Bowline Point Station in New York have 0.15 and 0.2 inch opening in the mesh nets, while the P. Pullium Plant in Wisconsin has 0.25 inch openings (ASCE, 1982).

INTAKE SCREENING SYSTEMS

FACT SHEET NO. 3

INCLINED SINGLE-ENTRY, SINGLE-EXIT TRAVELING SCREENS (ANGLED SCREENS)

DESCRIPTION:

The inclined traveling screens utilize standard through-flow traveling screens where the screens are set at an angle to the incoming flow as shown in the figure below. Angling the screens improves the fish protection effectiveness since the fish tend to avoid the screen face and move toward the end of the screen line, assisted by a component of the inflow velocity. A fish bypass facility with independently induced flow must be provided. The fish have to be lifted by fish pump, elevator, or conveyor and discharged to a point of safety away from the main water intake (Richards, 1977).

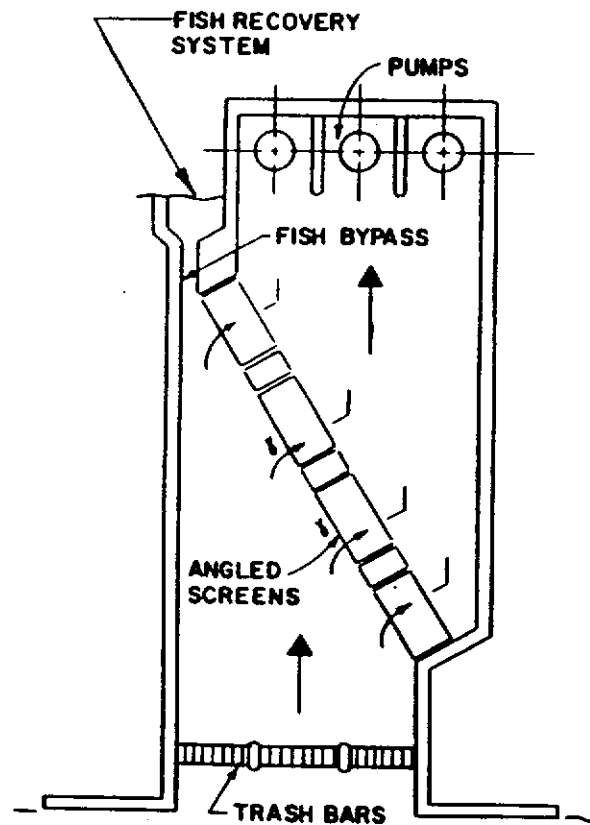

Inclined Traveling Screens (Richards, 1977)

DESCRIPTION:

Fish barrier nets are large mesh nets, which are placed in front of the entrance to the intake structure (see figure below). The size of the mesh needed is a function of the species that are present at a particular site. Fish barrier nets have been used at numerous facilities and lend themselves to intakes where the seasonal migration of fish and other organisms requires fish diversion facilities for only specific times of the year.

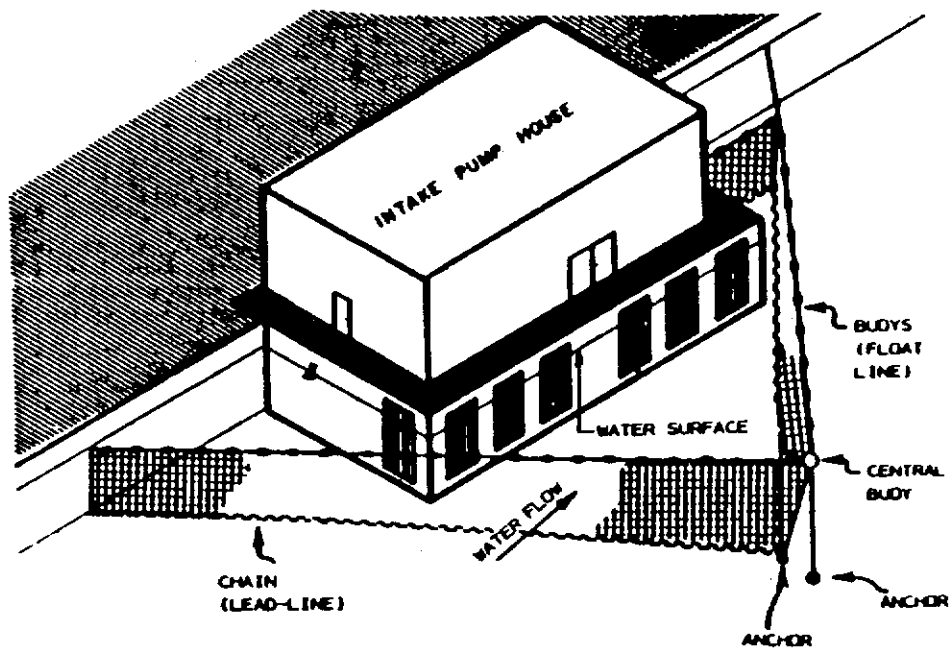

V-Arrangement of Fish Barrier Net (ASCE, 1982)

TESTING FACILITIES AND/OR FACILITIES USING THE TECHNOLOGY:

- Angled screens have been tested at the following facilities: New England Power Company's Brayton Point Station Unit 4; Southern California Edison San Onofre Station; and power plants on Lake Ontario and the Hudson River (ASCE, 1982).

RESEARCH/OPERATION FINDINGS:

- Testing at the New England Power Company's Brayton Point Station Unit 4 indicated that the survival efficiency for the major taxa exhibited an extremely wide range, from 0.1 percent for bay anchovy to 97 percent for tautog. Generally, the taxa fell into two groups: a hardy group with efficiency greater than 65 percent and a sensitive group with efficiency less than 25 percent.
- Southern California Edison at its San Onofre steam power plant had more success with angled louvers than with angled screens. The angled screen was not further considered because of the large bypass flow required to yield acceptable guidance efficiencies. Angled screens were not successful at San Onofre because the relatively high minimum approach velocity of 2 feet per second (ft/sec) that could be attained at the station.

DESIGN CONSIDERATIONS:

Many variables influence the performance of angled screens. The following recommended preliminary design criteria were developed in the studies for the Lake Ontario and Hudson River intakes (ASCE, 1982):

- Angle of screen to the waterway: 25 degrees.
- Average velocity of approach in the waterway upstream of the screens: 1 foot per second.
- Ratio of screen velocity to bypass velocity: 1:1.
- Minimum width of bypass opening: 6 inches.

ADVANTAGES:

- The fish are guided instead of impinged.
- The fish remain in water and are not subject to high pressure cleaning.

LIMITATIONS:

- Costs are higher than for conventional traveling screen.
- Angled screens need a stable water elevation.
- Angled screens require fish handling devices with independently induced flow (Richards, 1977).

ADDITIONAL REFERENCES:

Maxwell, W.A. Fish Diversion for Electrical Generating Station Cooling Systems—A State of the Art Report. Southern Nuclear Engineering, Inc. Report SNE-123. NUS Corporation. Dunedin, FL. 1973.

Richards, R.T. "Power Plant Circulating Water Systems—A Case Study." Short Course on the Hydraulics of Cooling Water Systems for Thermal Power Plants. Colorado State University. June 1978.

Stone and Webster Engineering Corporation. Studies to Alleviate Fish Entrapment at Power Plant Cooling Water Intakes. Final Report. Prepared for Niagara Mohawk Power Corporation and Rochester Gas and Electric Corporation. November 1976.

Weight, R.H. "Ocean Cooling Water System for 800 MW Power Station." J. Power Div., Proc. Am. Soc. Civil Engr. 84(6) (1958): 1888-1 to 1888-222.

REFERENCES:

ASCE. Design of Water Intake Structures for Fish Protection. American Society of Civil Engineers. New York, NY. 1982.

Richards, R.T. "Present Engineering Limitations to the Protection of Fish at Water Intakes." In Fourth National Workshop on Entrainment and Impingement, L.D. Jensen (Editor). Ecological Analysts, Inc., Melville, NY. Chicago, IL. December 1977. pp. 415-424.

U.S. EPA. Development Document for Best Technology Available for the Location, Design, Construction, and Capacity of Cooling Water Intake Structures for Minimizing Adverse Environmental Impact. U.S. Environmental Protection Agency, Effluent Guidelines Division, Office of Water and Hazardous Materials. April 1976.

ADVANTAGES:

- Diversion efficiencies of velocity caps in West Coast offshore intakes have exceeded 90 percent (ASCE, 1982).

LIMITATIONS:

- Velocity caps are difficult to inspect because of their location under water (EPA, 1976).
- In some studies, the velocity cap only minimized the entrainment of fish and did not eliminate it. Therefore, additional fish recovery devices are needed when such systems are used (ASCE, 1982; Mussalli, 1980).
- Velocity caps are ineffective in preventing passage of non-motile organisms and early life stage fish (Mussalli, 1980).

REFERENCES:

ASCE. Design of Water Intake Structures for Fish Protection. American Society of Civil Engineers. New York, NY. 1982.

EPRI. Intake Research Facilities Manual. Prepared by Lawler, Matusky & Skelly Engineers, Pearl River, for Electric Power Research Institute. EPRI CS-3976. May 1985.

Hanson, C.H., et al. "Entrapment and Impingement of Fishes by Power Plant Cooling Water Intakes: An Overview." Marine Fisheries Review. October 1977.

Mussalli, Y.G., E.P Taft III, and J. Larson. "Offshore Water Intakes Designed to Protect Fish." Journal of the Hydraulics Division Proceedings of the American Society of Civil Engineers, Vol. 106 Hy11 (1980): 1885-1901.

Pagano R., and W.H.B. Smith. Recent Development in Techniques to Protect Aquatic Organisms at the Water Intakes of Steam Electric Power Plants. Prepared for Electricite de France. MITRE Technical Report 7671. November 1977.

Ray, S.S., R.L. Snipes, and D.A. Tomljanovich. A State-of-the-Art Report on Intake Technologies. Prepared for Office of Energy, Minerals, and Industry, Office of Research and Development. U.S. Environmental Protection Agency, Washington, DC, by the Tennessee Valley Authority. EPA 600/7-76-020. October 1976.

U.S. EPA. Development Document for Best Technology Available for the Location, Design, Construction, and Capacity of Cooling Water Intake Structures for Minimizing Adverse Environmental Impact. U.S. Environmental Protection Agency, Effluent Guidelines Division, Office of Water and Hazardous Materials. April 1976.

INTAKE SCREENING SYSTEMS

SINGLE-ENTRY, DOUBLE-EXIT VERTICAL TRAVELING SCREENS

DESCRIPTION:

Single-entry, double-exit vertical traveling screens, known also as Passavant screens, were developed in Europe almost 30 years ago. The screen structure is mounted in a concrete well (well setting) or mounted on a platform surrounded by water (open setting). The screens are arranged in an endless belt and can be rotated continuously for an extended period of time. Water enters the center of the screens and passes from the inside to the outside of the screening surface as shown in Figure 1. All screened particles are removed by a spray from the outside and are collected in a waste trough inside the screens. The screen surface is theoretically double that of the conventional vertical traveling screens (Fritz, 1980). Various shapes of screen panels can be used, but the use of the semi-circular screen basket increases the screening area by approximately 60 percent and facilitates the removal of fish. These basket panels have a vertical water retaining lip along the bottom which retains debris and fish until the basket rotates directly over a sluice trough as shown in Figure 2.

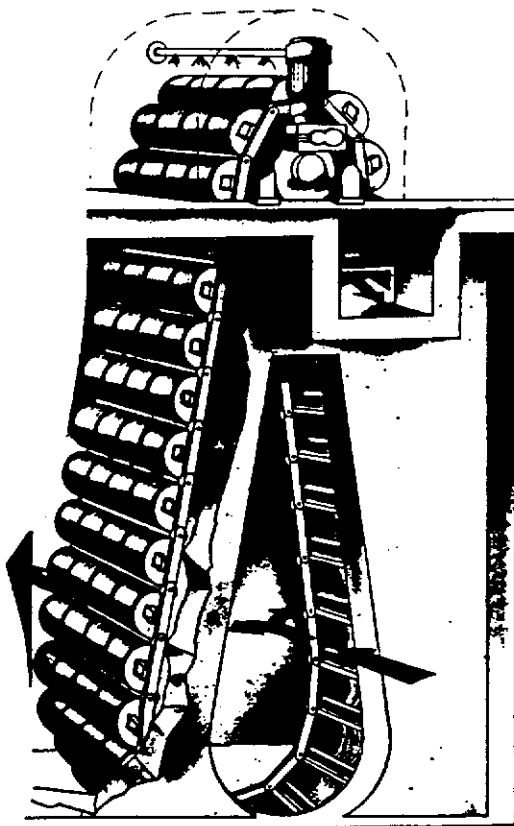

Figure 1
Passavant Screen (Siddle et al., 1978)

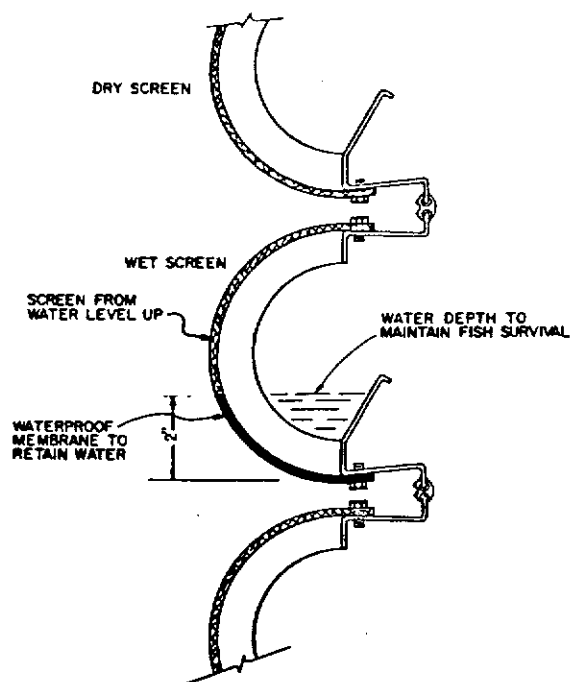

Figure 2
Semi-Circular Screen Basket
(Magliente et al., 1978)

TESTING FACILITIES AND/OR FACILITIES USING THE TECHNOLOGY:

- The available literature (EPA, 1976; Hanson, 1979; and Pagano et al., 1977) states that velocity caps have been installed at offshore intakes in Southern California, the Great Lakes Region, the Pacific Coast, the Caribbean, and overseas; however, exact locations are not specified.
- Velocity caps are known to be installed at the El Segundo, Redondo Beach, and Huntington Beach Steam Electric Stations and the San Onofre Nuclear Generation Station in Southern California (Mussalli, 1980; Pagano et al., 1977; EPRI, 1985).
- The Southern California Edison Company now installs velocity caps on all new offshore intakes (Pagano et al., 1977). Model tests have been conducted by a New York State Utility (ASCE, 1982), and several facilities have installed velocity caps in the New York State/Great Lakes Area, including the Nine Mile Point Nuclear Station in Lycoming, the Oswego Steam Electric Station, and the Somerset Generation Stations (EPRI, 1985).
- Additional facilities with velocity caps include the Edgewater Generation Station in Sheboygan, Wisconsin, and the Nantioke Thermal Generating Station in Nantioke, Ontario, Canada (EPRI, 1985).

RESEARCH/OPERATION FINDINGS:

- Horizontal velocities within a range of 0.5 to 1.5 feet per second (ft/sec) did not significantly affect the efficiency of a velocity cap tested at a New York facility; however, this design velocity may be specific to the species present at that site (ASCE, 1982).
- Preliminary decreases in fish entrapment averaging 80 to 90 percent were seen at the El Segundo and Huntington Beach Steam Electric Plants (Mussalli, 1980).
- Performance of the velocity cap may be associated with cap design and the total volumes of water flowing into the cap rather than to the critical velocity threshold of the cap (Mussalli, 1980).

DESIGN CONSIDERATIONS:

- Designs with rims around the cap edge prevent water from sweeping around the edge and causing turbulence and high velocities, thereby providing more uniform horizontal flows (EPA, 1976; Mussalli, 1980).
- Site-specific testing should be conducted to determine appropriate velocities to minimize entrainment of particular species in the intake (ASCE, 1982).
- Most structures are sized to achieve a low intake velocity between 0.5 and 1.5 ft/sec to lessen the chances of entrainment (ASCE, 1982).
- Design criteria developed for a model test conducted by Southern California Edison Company used a velocity through the cap of 0.5 to 1.5 ft/sec; the ratio of the dimension of the rim to the height of the intake areas was 1.5 to 1 (ASCE, 1982; Schuler, 1975).

TESTING FACILITIES AND/OR FACILITIES USING THE TECHNOLOGY:

- The Passavant screens are presently in operation in only two major U.S. steam electric power plants: the Central Power & Light Company's Barney Davis Station in Corpus Christi, Texas, and the Commonwealth Edison Company's Lassalle Nuclear Station in Seneca, Illinois.

RESEARCH/OPERATION FINDINGS:

- The Central Power & Light Company's study of a Passavant Screen (Murray et al., 1978) with a mesh size of 0.5 mm did not indicate that the single-entry, double-exit traveling screens are more effective at reducing impingement than the modified vertical traveling screens (Fact Sheet No. 2). The study reported high survival rates of 86 percent for impinged organisms. However, this survival rate was estimated from observations made only 10 to 15 minutes after collection. No results were reported for latent mortality or survival rates of larvae.

DESIGN CONSIDERATIONS:

- The semicircular design of the basket theoretically provides about 60 percent more screen area than a flat basket. However, the actual increase in area for a screen modified for fish recovery is only 10 to 15 percent because of the proximity of the baskets to one another and to the provision of a closed bucket for fish holding at the bottom end (ASCE, 1982; Mussalli et al., 1978).
- The amount of spray water ranges from 6 to 7 gallons per minute (gpm) per foot of screen (ACSE, 1982).
- Maximum velocity through the center port is 3.3 ft/sec (ASCE, 1982).

ADVANTAGES:

- In the Passavant screens, there is no possibility of debris carryover to the clean water side.
- Passavant screens have a larger screening area than the through-flow screen.

LIMITATIONS:

- The velocity of flow entering between the screen faces is usually high, which leads to increased impingement and entrainment (Richards, 1988).
- The well setting can contribute to higher impingement because the required screen well can act as an entrapment device.
- The use of fine mesh screens should reduce entrainment but can cause simultaneous increases in impingement of fish eggs and larvae.

DESCRIPTION:

A velocity cap is a device that is placed over vertical inlets at offshore intakes (see figure below). This cover converts vertical flow into horizontal flow at the entrance of the intake. The device works on the premise that fish will avoid rapid changes in horizontal flow. Fish do not exhibit this same avoidance behavior to the vertical flow that occurs without the use of such a device. Velocity caps have been implemented at many offshore intakes and have been successful in decreasing the impingement of fish.

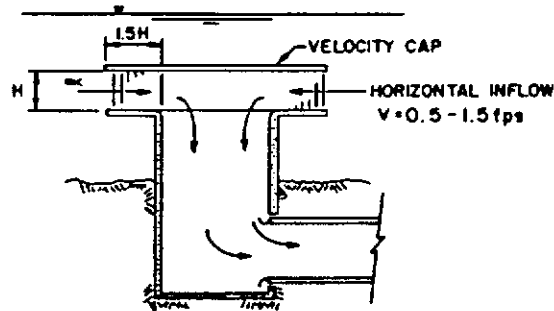
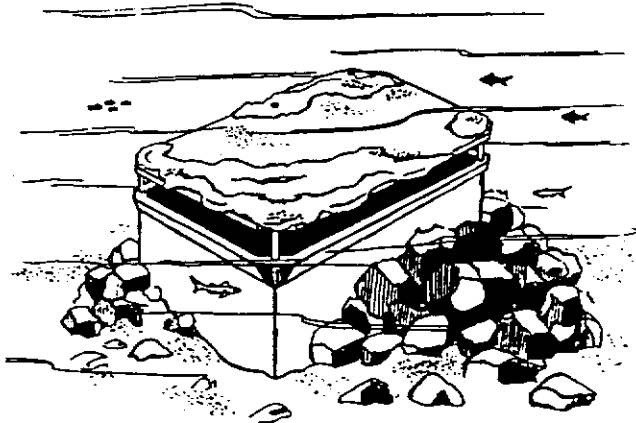

**Typical Offshore Cooling Water Intake Structure with Velocity Caps
(Helrey, 1985; ASCE, 1982)**

- The cost of the screens are 15 to 20 percent higher than for both the dual-flow screens (Fact Sheet No. 5) and the conventional traveling screens (Fact Sheet No. 1) (Richards, 1988).

REFERENCES:

ASCE. Design of Water Intake Structures for Fish Protection. American Society of Civil Engineers. New York, NY. 1982.

Fritz, E.S. Cooling Water Intake Screening Devices Used to Reduce Entrainment and Impingement. Topical Briefs: Fish and Wildlife Resources and Electric Power Generation, No. 9. July 1980.

Magliente, S.H., D.A. Tomljanovitch, J.H. Heuer, S. Vigander, and M. N. Smith. "Investigations on the Protection of Fish Larvae at Water Intakes Using Fine-Mesh Screening. Impingement Release Concept: Laboratory of Single-Entrance Double-Exit, Vertical Traveling Screen Concept." In Larval Exclusion Systems for Power Plant Cooling Water Intakes. San Diego, CA. February 1978. pp. 69-77.

Murray, L.S., and T.S. Jinnette. "Survival of Dominant Estuarine Organisms Impinged on Fine-Mesh Traveling Screens at the Barney M. Davis Power Station." In Larval Exclusion Systems for Power Plant Cooling Water Intakes. San Diego, CA. February 1978. pp. 79-87.

Mussalli, Y.G., Taft, E.P. and P. Hofmann. "Biological and Engineering Considerations in the Fine Screening of Small Organisms From Cooling Water Intakes." In Larval Exclusion Systems for Power Plant Cooling Water Intakes. San Diego, CA. February 1978. pp. 107-123.

Richards, R.T. "Alternative Water Screening for Thermal Power Plants." ASCE Journal of Hydraulics Engineering, Vol 114, No. 6. June 1988. pp. 578-597.

Siddle, K.R. and R.K. Sharma. "Engineering Aspects of Passavant Screens." In Larval Exclusion Systems for Power Plant Cooling Water Intakes. San Diego, CA. February 1978. pp. 65-68.

Stone and Webster Engineering Corporation, Studies to Alleviate Potential Fish Entrapment Problems—Final Report, Nine Mile Point Nuclear Station—Unit 2. Prepared for Niagara Mohawk Power Corporation. Syracuse, NY. May 1972.

Taft, E.P., and Y.G. Mussalli, "Angled Screens and Louvers for Diverting Fish at Power Plants." Proceedings of the American Society of Civil Engineers. Journal of Hydraulics Division. Vol 104 (1978): 623-634.

Thompson, J.S., and G.J. Paulick. An Evaluation of Louvers and Bypass Facilities for Guiding Seaward Migrant Salmonid Past Mayfield Dam in West Washington. Washington Department of Fisheries. Olympia, WA. 1967.

Watts, F.J. "Design of Culvert Fishways." University of Idaho Water Resources Research Institute Report. Moscow, ID. 1974.

INTAKE SCREENING SYSTEMS

FACT SHEET NO. 5

DOUBLE-ENTRY, SINGLE-EXIT VERTICAL TRAVELING SCREEN (DUAL FLOW SCREENS)

DESCRIPTION:

Double-entry, single-exit (dual flow) vertical traveling screens consist of a screen structure mounted in a concrete well (well setting) or mounted on a platform surrounded by water (open setting) as shown below. The unit is turned so that the approach flow is parallel to the faces of the screen. Water enters from both the ascending and descending sides of the screens and discharges from the downstream end between the faces while the upstream end is blocked off. The screen faces, operating mechanism, screen speed, and spray wash system are similar to the conventional traveling screen (Fact Sheet No. 1). In the open setting concept, the pump is attached directly to the screen. The open setting offers increased fish protection since there is no confining structure, such as a well, that may trap fish (ASCE, 1982). The dual flow screen is used in Europe but is not popular in the United States.

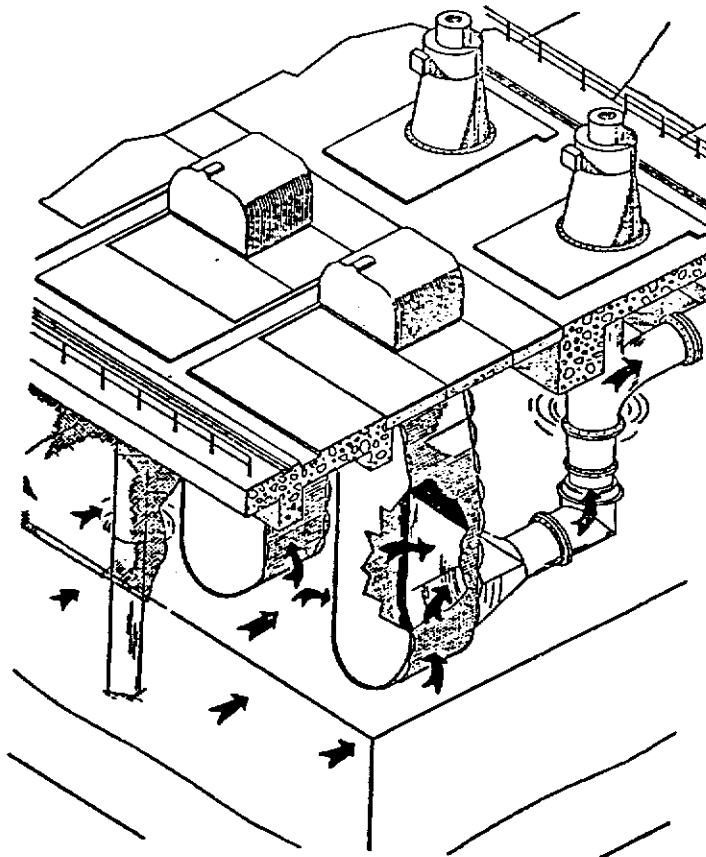

Dual Flow Traveling Screens—Open Setting (ASCE, 1982)

Bates, D.W., and R. Vinsonhaler, "The Use of Louvers for Guiding Fish." Trans. Am. Fish. Soc. 86 (1956): 39-57.

Bates, D.W., and S.G., Jewett Jr. "Louver Efficiency in Deflecting Downstream Migrant Steelhead." Trans. Am. Fish Soc. 90(3) (1961): 336-337.

Cada, G.G., and A.T. Szluha. "A Biological Evaluation of Devices Used for Reducing Entrainment and Impingement Losses at Thermal Power Plants." In International Symposium on the Environmental Effects of Hydraulic Engineering Works. Environmental Sciences Division, Publication No. 1276. Oak Ridge National Lab. Oak Ridge TN. 1978.

Cannon, J.B., et al. "Fish Protection at Steam Electric Power Plants: Alternative Screening Devices." ORAL/TM-6473. Oak Ridge National Lab. Oak Ridge, TN. 1979.

Downs, D.I., and K.R. Meddock, "Design of Fish Conserving Intake System." Journal of the Power Division, ASCE, Vol. 100, No. P02. Proc. Paper 1108 (1974): 191-205.

Ducharme, L.J.A. "An Application of Louver Deflectors for Guiding Atlantic Salmon (*Salmo salar*) Smolts from Power Turbines." Journal Fisheries Research Board of Canada. 29 (1974): 1397-1404.

Hallock, R.J., R.A. Iselin, and D.H.J. Fry. "Efficiency Tests of the Primary Louver Systems, Tracy Fish Screen, 1966-67." Marine Resources Branch, California Department of Fish and Game. 1968.

Katapodis, C., et al. A Study of Model and Prototype Culvert Baffling for Fish Passage. Fisheries and Marine Service, Tech. Report No. 828. Winnipeg, Manitoba. 1978.

Kerr, J.E., "Studies on Fish Preservation at the Contra Costa Steam Plant of the Pacific Gas and Electric Co." California Fish and Game Bulletin No. 92. 1953.

Marcy, B.C., and M.D. Dahlberg. Review of Best Technology Available for Cooling Water Intakes. NUS Corporation. Pittsburgh, PA. 1978.

NUS Corp. "Review of Best Technology Available for Cooling Water Intakes." Los Angeles Dept. of Water & Power Report. Los Angeles, CA. 1978.

Schuler, V.J. "Experimental Studies in Guiding Marine Fishes of Southern California with Screens and Louvers." Ichthyol. Assoc., Bulletin 8. 1973.

Skinner, J.E. "A Functional Evaluation of Large Louver Screen Installation and Fish Facilities Research on California Water Diversion Projects." In L.D. Jensen (Editor), Entrainment and Intake Screening. Proceedings of the Second Entrainment and Intake Screening Workshop. The John Hopkins University. Baltimore, MD. February 5-9, 1973. pp. 225-249. (Edison Electric Institute and Electric Power Research Institute. EPRI Publication No. 74-049-00-5. 1974).

Stone and Webster Engineering Corporation. Final Report, Indian Point Flume Study. Prepared for Consolidated Edison Company of New York. July 1976.

TESTING FACILITIES AND/OR FACILITIES USING THE TECHNOLOGY:

Several facilities have installed or are reviewing the installation of dual flow screens primarily as a way to increase debris handling capabilities (EPRI, 1989). The following facilities tested the dual flow screens for impingement:

- Baltimore Gas and Electric's Calvert Cliffs Nuclear Power Plant
- Houston Lighting and Power Company's Cedar Bayou Station
- Niagara Mohawk Power Corporation's Dunkirk Steam Station

RESEARCH/OPERATION FINDINGS:

- Results from these studies do not indicate any significant increase in impingement survival over conventional vertical traveling screens, especially when the dual flow screens are incorporated at an intake designed with low approach velocities (EPRI, 1989).
- Because dual flow screens have been installed at water intakes for their debris handling capabilities and not to satisfy environmental concerns, only limited information is available on impingement and survival impacts.

DESIGN CONSIDERATIONS:

- The screen faces, operating mechanisms, screen speed, and spray wash system are similar to the conventional traveling screen (Fact Sheet No. 1).

ADVANTAGES:

- No debris is "carried-over" into the clean water side. Any material not removed by the spray system returns to the unscreened waterway on the descending screen.
- Increased screening area is available for a given width of screen.

LIMITATIONS:

- Fish impinged on the descending side will remain impinged for a longer period than they would on a conventional traveling screen, assuming equal screen speeds (ASCE, 1982).
- Because the well setting requires abrupt changes in water flow direction as the water passes through the screen, the velocity distribution across the screen face is uneven. This may result in more fish becoming impinged (U.S. EPA, 1976).
- The well setting does not provide any escape route for fish other than swimming back out of the channel.

REFERENCES:

ASCE. Design of Water Intake Structures for Fish Protection. American Society of Civil Engineers. New York, NY. 1982.

- Fish handling devices are needed to take fish away from the louver barrier.
- Louver barriers may or may not require additional screening devices for removing solids from the intake waters. If such devices are required, they may add a substantial cost to the system (EPA, 1976).
- Louvers may not be appropriate for offshore intakes (Mussalli, 1980).

REFERENCES:

Chow, W., I.P. Murarka, and R.W. Broksen. "Entrainment and Impingement in Power Plant Cooling Systems." Literature Review. Journal of Water Pollution Control Federation. 53 (6) (1981): 965-973.

EPRI. Intake Research Facilities Manual. Prepared by Lawler, Matusky & Skelly Engineers, Pearl River, for Electric Power Research Institute. EPRI CS-3976. May 1985.

Hadderingh, R.H. "Fish Intake Mortality at Power Stations, the Problem and its Remedy." N.V. Kema, Arnheem, Netherlands. Hydrological Bulletin 13(2-3) (1979): 83-93.

Mussalli, Y.G., E.P. Taft, and P. Hoffman. "Engineering Implications of New Fish Screening Concepts." In Fourth National Workshop on Entrainment and Impingement. L.D. Jensen (Editor). Ecological Analysts, Inc., Melville, NY. Chicago, IL. December 1977.

Mussalli, Y.G., E.P. Taft III, and J. Larson. "Offshore Water Intakes Designed to Protect Fish." Journal of the Hydraulics Division Proceedings of the American Society of Civil Engineers. Vol. 106 Hy11 (1980): 1885-1901.

O'Keefe, W. "Intake Technology Moves Ahead." Power. January 1978.

Ray, S.S., R.L. Snipes, and D.A. Tomljanovich. A State-of-the-Art Report on Intake Technologies. Prepared for Office of Energy, Minerals, and Industry, Office of Research and Development, U.S. Environmental Protection Agency, Washington, DC by the Tennessee Valley Authority. EPA 600/7-76-020. October 1976.

U.S. EPA. Development Document for Best Technology Available for the Location, Design, Construction, and Capacity of Cooling Water Intake Structures for Minimizing Adverse Environmental Impact. U.S. Environmental Protection Agency, Effluent Guidelines Division, Office of Water and Hazardous Materials. April 1976.

Uziel, Mary S. "Entrainment and Impingement at Cooling Water Intakes." Literature Review. Journal Water Pollution Control Federation. 52 (6) (1980): 1616-1630.

ADDITIONAL REFERENCES:

Adams, S.M. et al. Analysis of the Prairie Island Nuclear Generating Station—Intake Related Studies. Report to Minnesota Pollution Control Agency. Oak Ridge National Lab. Oak Ridge, TN. 1979.

EPRI. Intake Technology: Research Status, Electric Power Research Institute. EPRI GS-6293. March 1989.

U.S. EPA. Development Document for Best Technology Available for the Location, Design, Construction, and Capacity of Cooling Water Intake Structures for Minimizing Adverse Environmental Impact. U.S. Environmental Protection Agency, Effluent Guidelines Division, Office of Water and Hazardous Materials. April 1976.

- At the Maxwell Irrigation Canal in Oregon, louver spacing was 5 cm with a 98 percent efficiency of deflecting immature steelhead and above 90 percent efficiency for the same species with the louver spacing of 10.8 cm.
- At the Ruth Falls Power Plant in Nova Scotia, the results of a 5-year evaluation for guiding salmon smelts showed that the optimum spacing was to have wide bar spacing at the widest part of the louver with a gradual reduction in the space approaching the bypass. The site used a bypass approach velocity of 1.0:1.5 (Ray et al., 1976).
- Coastal species in California were deflected optimally (Schuler and Larson, 1974 and Ray et al., 1976) with 2.5 cm spacing of the louvers, 20 degree louver array to the direction of flow, and approach velocities of 0.6 cm per second.

DESIGN CONSIDERATIONS:

The most important parameters of the design of louver barriers include the following:

- The angle of the louver vanes in relation to the channel velocity
- The spacing between the louvers as it relates to the size of the fish
- Ratio of bypass velocity to channel velocity
- Shape of guide walls
- Louver array angles
- Approach velocities.

Site-specific modeling may be needed to take into account species-specific considerations and to optimize the design efficiency (EPA, 1976; O'Keefe, 1978).

ADVANTAGES:

- Louver designs have been shown to be very effective in diverting fish (EPA, 1976).

LIMITATIONS:

- The costs of installing intakes with louvers may be substantially higher than other technologies because of design costs and the precision required during construction.
- Extensive species-specific field testing may be required.
- The shallow angles required for the efficient design of a louver system require a long line of louvers, which increase the cost compared to other systems (Ray et al., 1976).
- Water level changes must be kept to a minimum to maintain the most efficient flow velocity.

DESCRIPTION:

Horizontal traveling screens are continuously moving screens that span the incoming flow of water. The screens rotate horizontally in the waterway with the upstream face placed at an angle to guide fish in a manner similar to louvers and angled screen systems. The screens are designed to guide juvenile and adult fish to a bypass without impingement and to collect fish larvae and eggs and carry them to the fish bypass for removal. Many mechanical problems have occurred during screen testing and have delayed further research (ASCE, 1982). These mechanical problems result mainly from the high speed continuous operation requirements of the horizontal traveling screens. Because of these operational limitations, the screens are not currently manufactured. Application of these screens to large industrial intakes would likely require extensive and costly research (EPA, 1976).

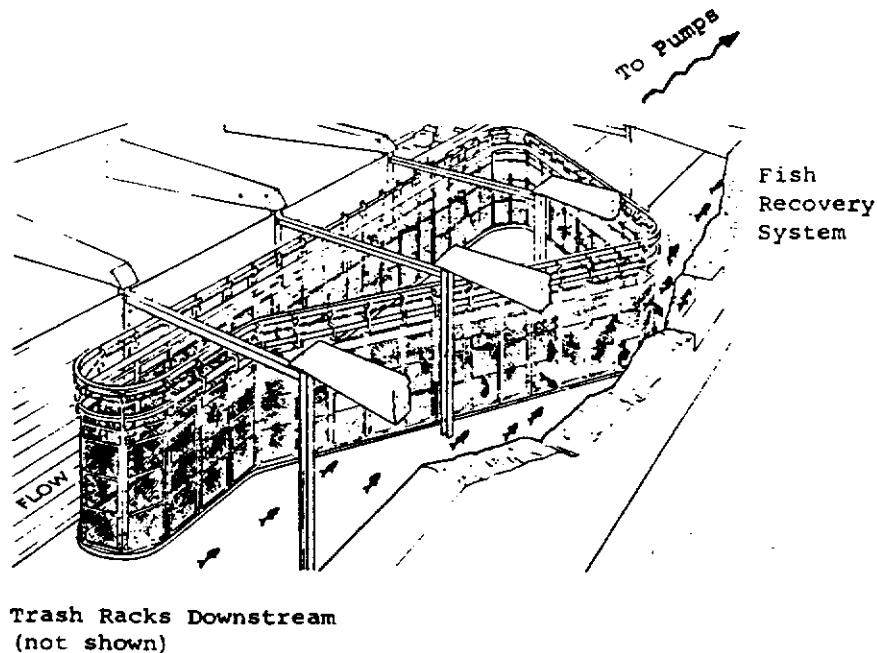

Horizontal Traveling Screen (ASCE, 1982)

TESTING FACILITIES AND/OR FACILITIES USING THE TECHNOLOGY:

- Louver barrier devices have been tested and/or are in use at the following California facilities: California Department of Water Resource's Tracy Pumping Plant; the California Department of Fish and Game's Delta Fish Protective Facility in Byron; and the San Onofre Nuclear Generating Station in San Clemente (EPA, 1976; EPRI, 1985). In addition, two other plants also have louvers at their facilities: Ruth Falls Power Plant in Nova Scotia and the Nine Mile Point Nuclear Power Station on Lake Erie. Louvers have also been tested at the Ontario Hydro Laboratories in Toronto, Ontario, Canada (Ray et al., 1976).

RESEARCH/OPERATION FINDINGS:

Research has shown the following generalizations to be true regarding louver barriers: (1) the fish separation performance of the louver barrier decreases with an increase in the velocity of the flow through the barrier; (2) efficiency increases with fish size (EPA, 1976; Hadderingh, 1979); (3) individual louver misalignment has a beneficial effect on the efficiency of the barrier; (4) the use of center walls provides the fish with a guide wall to swim along, thereby improving efficiency (EPA, 1976); and (5) the most effective slat spacing and array angle to flow depend upon the size, species, and swimming ability of the fish to be diverted (Ray et al., 1976).

In addition, the following conclusions were drawn during specific studies:

- Testing of louvered intake structures offshore was performed at a New York facility. The louvers were spaced 10 inches apart to minimize clogging. The array was angled at 11.5 percent to the flow. Center walls were provided for fish guidance to the bypass. Test species included alewife and rainbow smelt. The mean efficiency predicted was between 22 and 48 percent (Mussalli 1980).
- During testing at the Delta Facility's intake in Byron, California, the design flow was 6,000 cubic feet per second (cfs), the approach velocity was 1.5 to 3.5 feet per second (ft/sec), and the bypass velocities were 1.2 to 1.6 times the approach velocity. Efficiencies were found to drop with an increase in velocity through the louvers. For example, at 1.5 to 2 ft/sec the efficiency was 61 percent for 15 millimeter long fish and 95 percent for 40 millimeter fish. At 3.5 ft/sec, the efficiencies were 35 and 70 percent (Ray et al., 1976).
- The efficiency of the louver device is highly dependent upon the length and swimming performance of a fish. Efficiencies of lower than 80 percent have been seen at facilities where fish were 1.6 inches or less in length (Mussalli, 1980).
- At the Tracy Fish Collection Facility, an efficiency of 97 percent was realized with the louver placed 15 degrees to the direction of the flow with four evenly spaced bypasses. The slats were 90 degrees to the direction of the flow and spaced 2.5 centimeters (cm) apart (Ray et al., 1976).

TESTING FACILITIES AND/OR FACILITIES USING THE TECHNOLOGY:

- Horizontal traveling screens have not been successfully operated at steam electric power plants.

RESEARCH/OPERATION FINDINGS:

- Full scale testing on the Grande-Ronde River near Troy, Oregon have shown that the screens (designated Mark VII) are very effective in reducing impingement and entrainment. However, due to considerable operational limitations, the screens were never fully developed (Prentice, 1973).

DESIGN CONSIDERATIONS:

- None Found.

ADVANTAGES:

- The horizontal traveling screens form a complete physical barrier.
- The screens show a high diversion efficiency of fish and release impinged fish into a bypass without passing the air-water interface.

LIMITATIONS:

- The screens can only be used where water depth does not exceed approximately 10 feet (3 meters).
- The screens are only effective where the water level is relatively constant, a condition which rarely exists at steam electric power plants.

REFERENCES:

ASCE. Design of Water Intake Structures for Fish Protection. American Society of Civil Engineers. New York, NY. 1982.

Prentice, E.F., and F.J. Ossiander. "Fish Diversion Systems and Biological Investigation of Horizontal Traveling Screen Model VII." In Second Workshop on Entrainment and Intake Screening. Baltimore, MD. February 1973.

U.S. EPA. Development Document for Best Technology Available for the Location, Design, Construction, and Capacity of Cooling Water Intake Structures for Minimizing Adverse Environmental Impact. U.S. Environmental Protection Agency, Effluent Guidelines Division, Office of Water and Hazardous Materials. April 1976.

DESCRIPTION:

Louver barriers are devices comprising a series of vertical panels placed at an angle to the direction of the flow (typically 15 to 20 degrees). Each panel is placed at an angle of 90 degrees to the direction of the flow (Hadderingh, 1979). The louver panels provide an abrupt change in both the flow direction and velocity (see figure below). This creates a barrier that fish can immediately sense and avoid. Once the change in flow/velocity is sensed by fish, they typically align themselves with the direction of the current and move laterally away from the turbulence. This behavior further guides fish into a current created by the system which is parallel to the face of the louvers. The current pulls the fish along the line of the louvers until they enter a fish bypass or other fish handling device at the end of the louver line. The louvers may be either fixed or rotated similar to a traveling screen. Flow straighteners are frequently placed behind the louver systems.

Louver barriers have been very successful and have been installed at numerous irrigation intakes, water diversion projects, and steam electric and hydroelectric facilities. It appears that this technology has, in general, become accepted as a viable option to divert fish.

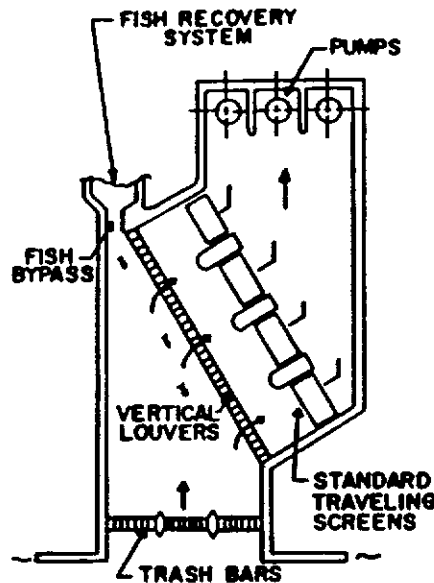

Top View of a Louver Barrier with Fish Bypass (Hadderingh, 1979)

INTAKE SCREENING SYSTEMS

FINE MESH SCREENS MOUNTED ON
TRAVELING SCREENS**DESCRIPTION:**

Fine mesh screens are used for screening eggs, larvae, and juvenile forms of fish from cooling water intake systems. The concept of using fine mesh screens for exclusion of larvae relies on gentle impingement on the screen surface or retention of larvae within the screening basket, washing of screen panels or baskets to transfer organisms into a sluiceway, and then sluicing the organisms back to the source waterbody (Sharma, 1978). Fine mesh with openings as small as 0.5 millimeters (mm) has been used depending on the size of the organisms to be protected. Fine mesh screens have been used on conventional traveling screens and single-entry, double-exit screens. The ultimate success of an installation using fine mesh screens is contingent on the application of satisfactory handling and recovery facilities to allow the safe return of impinged organisms to the aquatic environment (Pagano et al., 1977).

Criteria for the design, operation, and maintenance of traveling screens are very well established for the standard 3/8 inch mesh screen. Metal screens can be used with both types of vertical traveling screens, whereas screens of synthetic fabric have been used in the single entry, double-exit design only. The use of synthetic fabric has not been demonstrated for the conventional vertical traveling screen.

TESTING FACILITIES AND/OR FACILITIES USING THE TECHNOLOGY:

- In early 1979, Tampa Electric Company (TEC) evaluated a prototype dual flow screen system with 0.5 mm fine mesh at its Big Ben Station as part of a 316(b) demonstration project.
- Central Hudson and Gas Electric Corporation installed woven wire 3.2-mm fine mesh screens on three vertical traveling screens at Danskammer Point Generating Station Unit 3 located on the Hudson River.

RESEARCH/OPERATION FINDINGS:

- Tampa Electric Company conducted additional biological studies during the 1987 spawning season to verify expected screening efficiencies. Screening efficiencies of 95 percent for eggs, 85.5 percent for larvae, and 100 percent for invertebrates were reported (Brueggemeyer et al., 1988).
- Preliminary results from a study initiated in 1987 by the Central Hudson and Gas Electric Corporation indicate that the fine mesh screens collect smaller fish compared to conventional screens; mortality for the smaller fish was relatively high, with similar survival between screens for fish in the same length category (EPRI, 1989).

Sharma, R.K. "A Synthesis of Views Presented at the Workshop." In Larval Exclusion Systems for Power Plant Cooling Water Intakes. San Diego, CA. February 1978. pp. 235-237.

- Generally, the use of fine mesh on conventional traveling screens has not been demonstrated as an effective technology for reducing mortality or entrainment losses (EPRI 1989).

DESIGN CONSIDERATIONS:

Biological effectiveness for the whole cycle, from impingement to survival in the source water body, should be investigated thoroughly prior to implementation of this option. This includes the following:

- The intake velocity should be very low so that if there is any impingement of larvae on the screens, it is gentle enough not to result in damage or mortality.
- The wash spray for the screen panels or the baskets should be low-pressure so as not to result in mortality.
- The sluiceway should provide smooth flow so that there are no areas of high turbulence; enough flow should be maintained so that the sluiceway is not dry at any time.
- The species life stage, size, and body shape and the ability of the organisms to withstand impingement should be considered with time and flow velocities.
- The type of screen mesh material used should be considered. For instance, synthetic meshes may be smooth and have a low coefficient of friction, features that might help to minimize abrasion of small organisms. However, they also may be more susceptible to puncture than metallic meshes (Mussalli, 1977).

ADVANTAGES:

- There are indications that fine mesh screens reduce entrainment.

LIMITATIONS:

- Fine mesh screens usually increased the impingement of fish.
- Because of the small screen openings, these screens will clog much faster than the conventional 3/8 inch screens.

REFERENCES:

Bruggemeyer, V., D. Condrick, K. Durrel, S. Mahadevan, and D. Brizck. "Full Scale Operational Demonstration of Fine Mesh Screens at Power Plant Intakes." In Fish Protection at Steam and Hydroelectric Power Plants. EPRI CS/EA/AP-5664-SR. March 1988. pp. 251-265.

EPRI. Intake Technologies: Research Status. Electrical Power Research Institute, EPRI GS-6293. March 1989.

TESTING FACILITIES AND/OR FACILITIES USING THE TECHNOLOGY:

- Artificial filter beds are not operational at steam electric plants.

RESEARCH/OPERATION FINDINGS:

- A filter bed was installed for steam electric plant make-up on the West Branch of the Susquehanna River to draw make-up water for the Montour Steam Electric Station of the Pennsylvania Power and Light Company. The artificial filter bed could not be prevented from clogging and was abandoned and replaced with a perforated pipe (Richards, 1978).
- Similarly in 1972, a filter bed was first selected for the make-up water system for Nuclear Project No. 2 of the Washington Public Power Supply System (WPSS-2) on the Columbia River. Ultimately, the filter concept was set aside in favor of the modified perforated pipe (Richards, 1978).
- Although this concept has high screening potential, consensus was reached in the Workshop on Larval Exclusion Systems for Power Plants Cooling Water Intakes that operational difficulties discourage any further research and development of this concept (Sharma, 1978).

DESIGN CONSIDERATIONS:

- None found.

ADVANTAGES:

- Little or no biological impact is expected to occur as a result of operation of artificial filter beds.

LIMITATIONS:

- Artificial filter beds can only be sited on water bodies that have low concentrations of suspended particles and where potential for biofouling is low.
- Clogging and biofouling due to operation, silting, and decreased water quality due to maintenance backwash make artificial filter beds unattractive for use at steam electric plants.
- The artificial filter beds have limited intake capacity.

REFERENCES:

ASCE. Design of Water Intake Structures for Fish Protection. American Society of Civil Engineers. New York, NY. 1982.

Richards, R.T. "Engineering Considerations in the Use of Artificial Filter Beds." In Larval Exclusion Systems for Power Plant Cooling Water Intakes. San Diego, CA. February 1978. pp. 5-12.

Pagano, R., and W.H.B. Smith. Recent Developments in Techniques to Protect Aquatic Organisms at the Water Intakes of Steam-Electric Power Plants. Prepared for Electricite' de France. MITRE Technical Report 7671. November 1977.

Mussalli, Y.G., E.P. Taft, and P. Hofmann. "Engineering Implications of New Fish Screening Concepts." In Fourth Workshop on Larval Exclusion Systems for Power Plant Cooling Water Intakes. San Diego, CA. February 1978. pp. 367-376.

Sharma, R.K., "A Synthesis of Views Presented at the Workshop." In Larval Exclusion Systems for Power Plant Cooling Water Intakes. San Diego, CA. February 1978. pp. 235-237.

DESCRIPTION:

Artificial filter bed intakes utilize a prepared granular filter material to prevent entrance of debris and aquatic life into a water withdrawal facility. Artificial filter beds have been extensively used for the filtration of municipal water supplies for a considerable period of time. The figure below shows a schematic of an artificial filter bed. An area is excavated and back-filled with a specially graded filter medium. A perforated pipe located under this filter collects the filtered water and carries it to the pump structure. Clogging and biofouling due to operation and silting, decreased water quality due to maintenance backwash, and limited intake capacity make it unattractive for use at steam electric plants (Richards, 1978; ASCE, 1982).

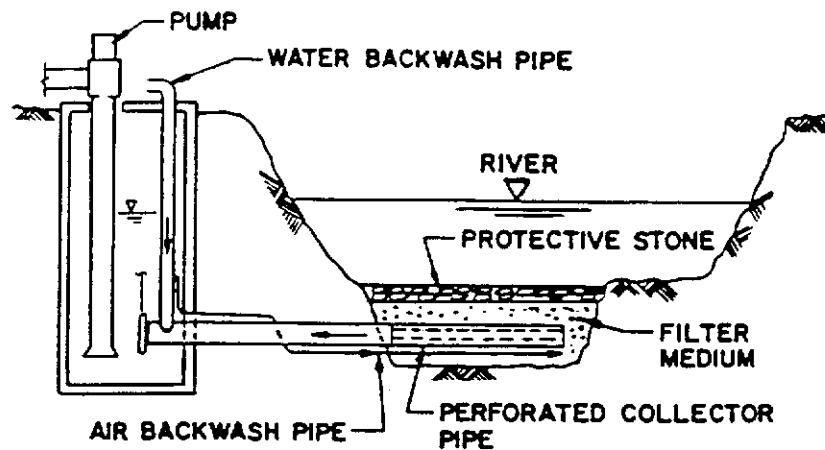

Artificial Filter Bed (Richards, 1978)

DESCRIPTION:

Horizontal drum screens, widely used outside the United States, are screens mounted on large revolving wheels. The screens are placed with their longitudinal axis horizontal across the intake channel. In general, the size of the structure required to mount such screens is substantially larger than the size of the structure required for a traveling screen of similar capacity. There is little evidence to indicate that these screens offer any fish protection advantage over the conventional traveling screens (ASCE, 1982). Several variations of horizontal drum screens are briefly described below.

Single-Entry Rotating Drum Screen:

Water enters the open and unscreened end of the rotating cylinder and exits through the screened periphery. The drum is limited in size to about 30 feet (9 meters) in diameter because of the cantilever nature of the shaft support. The drum is only used for low capacity intakes (EPA, 1976; ASCE, 1982; Richards, 1988).

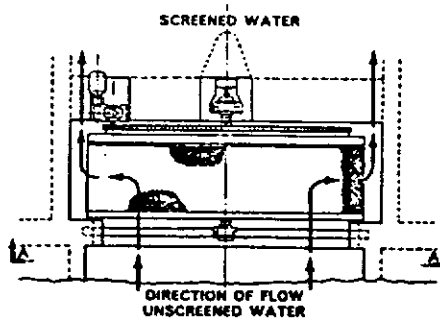
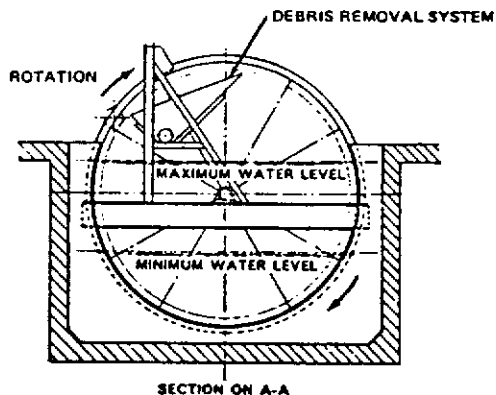

Single-Entry Rotating Drum Screen (EPA, 1976)

REFERENCES:

ASCE. Task Committee on Fish-handling of Intake Structures of the Committee of Hydraulic Structures. Design of Water Intake Structures for Fish Protection. American Society of Civil Engineers. New York, NY. 1982.

EPRI. Intake Research Facilities Manual. Prepared by Lawler, Matusky & Skelly Engineers, Pearl River, for Electric Power Research Institute. EPRI CS-3976. May 1985.

Fritz, E.S. Cooling Water Intake Screening Devices Used to Reduce Entrainment and Impingement. Fish and Wildlife Service, Topical Briefs: Fish and Wildlife Resources and Electric Power Generation, No 9. July 1980.

Schrader, B.P., and B.A. Ketschke. "Biological Aspects of Porous-Dike Intake Structures." In Larval Exclusion Systems for Power Plant Cooling Water Intakes. San Diego, CA. August 1978. pp. 51-63.

Sharma, R.K. "A Synthesis of Views Presented at the Workshop." In Larval Exclusion Systems For Power Plant Cooling Water Intakes. San Diego, CA. February 1978. pp. 235-237.

Double-Entry Rotating Drum Screen:

Water enters both ends of a rotating cylinder and exits through the screened periphery. Diameters up to 80 feet (24 meters) have been installed, and 30 to 40 feet (9 to 12 meters) diameter drums are common. This type of drum screen is less widely used than the single-entry drum screens.

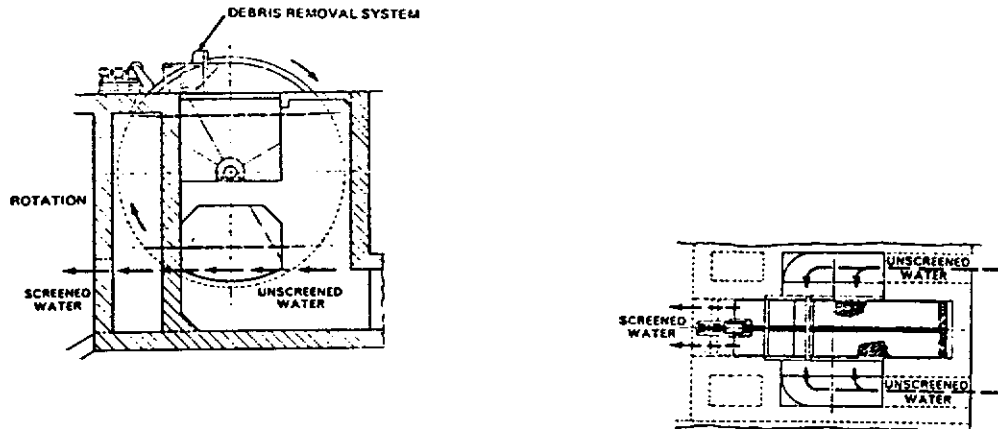

Double-Entry Rotating Drum Screen (ASCE, 1976)

Outside-to-Inside-Flow Drum Screens:

Water flows from outside to the inside of the drum. The manufacturer claims that this type of drum screen avoids the problem of debris collecting inside the cylinder. Debris collection is a problem for both the single-entry and double-entry drum screens.

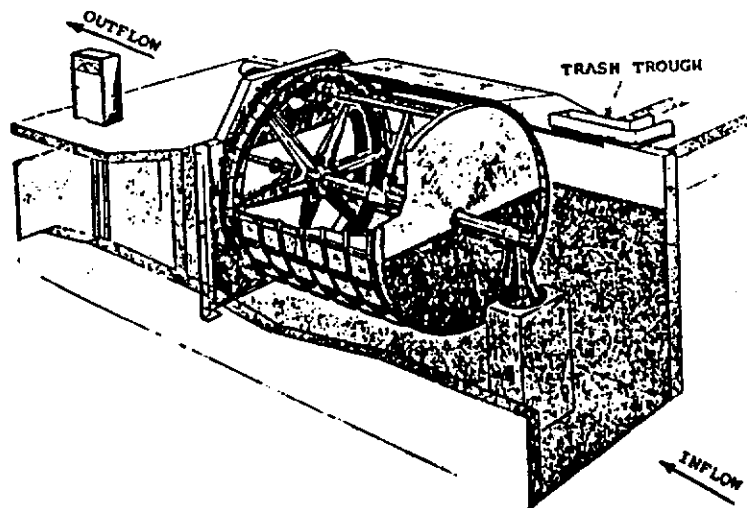

Outside-to-Inside-Flow Drum Screen (Richards, 1988)

TESTING FACILITIES AND/OR FACILITIES USING THE TECHNOLOGY:

- Two facilities both testing and using the technology are Wisconsin Electric Power Company's Point Beach Nuclear Plant in Two Rivers and Northern Indiana Public Service Company's Baily Generating Station in Charleston (EPRI, 1985). New England Power Company's Brayton Point Generating Station in Somerset, Massachusetts, has also tested the technology.

RESEARCH/OPERATION FINDINGS:

- Schrader and Ketschke (1978) studied the porous dike at Wisconsin Electric Service Company's Lakeside Plant on Lake Michigan and found that numerous fish penetrated large void spaces, but for most fish, accessibility was limited.
- The biological effectiveness of screening of fish larvae and the engineering practicability have not been established (ASCE, 1982).
- The size of the pores in the dike dictates the degree of maintenance due to biofouling and clogging by debris.
- Ice build-up and frazil ice may create problems as evidenced at the Point Beach Nuclear Plant (EPRI, 1985).

DESIGN CONSIDERATIONS

- The presence of currents past the dike aids in diverting fish and may increase biological effectiveness.
- The size of pores in the dike determine the extent of biofouling and clogging by debris (Sharma, 1978).
- Filtering material must be of a size that permits free passage of water but still prevents entrainment and impingement.

ADVANTAGES:

- Dikes can be used at marine, fresh, and estuarine locations.

LIMITATIONS:

- The major problem with porous dikes results from clogging by debris and silt, and from fouling by colonization of fish and plant life.
- Backflushing, which is often used by other systems for debris removal, is not feasible at a dike installation.
- Predation of organisms screened at these dikes may offset any biological effectiveness (Sharma, 1978).

TESTING FACILITIES AND/OR FACILITIES USING THE TECHNOLOGY:

- Drum screens are not used at U.S. steam power plants.

RESEARCH/OPERATION FINDINGS:

- There is little evidence to indicate that horizontal drum screens offer any fish protection advantage over the conventional traveling screens (ASCE, 1982).

DESIGN CONSIDERATIONS:

- Important design parameters include mesh size, drum diameter, drum rotation velocity, and flow velocities through the screens. The water flow velocities through the screens are difficult to control since portions of the screen are alternately moving with and against the intake flow (EPA, 1976).

ADVANTAGES:

- The main advantages of horizontal drum screens are their simplicity, fewer moving parts than conventional traveling screens, and ease of maintenance. For instance, the failure of the screen wash system would not necessarily stop screen operation as it would for traveling screens (Richards, 1988).

LIMITATIONS:

- The main disadvantage of the horizontal drum screen is capital cost. The screen structure is more costly than the conventional traveling screens because of the larger size. Estimates show that horizontal drum screens cost approximately \$821,000 more than conventional traveling screens (1982 dollars). Increased costs result from power, operation, and maintenance costs (Richards, 1988).

REFERENCES:

ASCE. Design of Water Intake Structures for Fish Protection. American Society of Civil Engineers. New York, NY. 1982.

Richards, R.T. "Alternative Water Screening for Thermal Power Plants." ASCE Journal of Hydraulics Engineering, Vol 114, No. 6. June 1988. pp. 578-597.

U.S. EPA. Development Document for Best Technology Available for the Location, Design, Construction, and Capacity of Cooling Water Intake Structures for Minimizing Adverse Environmental Impact. U.S. Environmental Protection Agency, Effluent Guidelines Division, Office of Water and Hazardous Materials. April 1976.

DESCRIPTION:

Porous dikes, also known as leaky dams or leaky dikes, are filters resembling a breakwater surrounding a cooling water intake. The core of the dike consists of cobble or gravel, which permits free passage of water. The dike acts both as a physical and a behavioral barrier to aquatic organisms and is depicted in the figure below. The filtering mechanism includes a breakwater or some other type of barrier and the filtering core (Fritz, 1980). Tests conducted to date have indicated that the technology is effective in excluding juvenile and adult fish. However, its effectiveness in screening fish eggs and larvae is not established (ASCE, 1982).

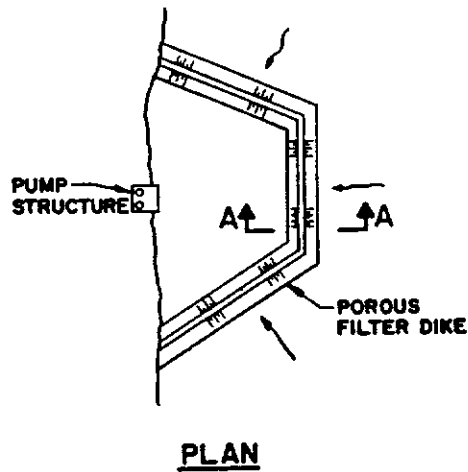
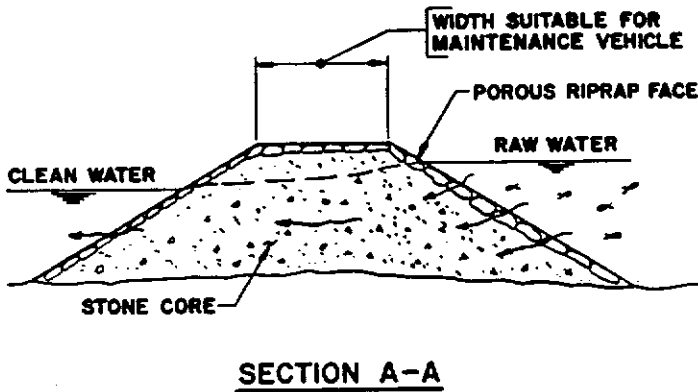

Porous Dike (Schrader and Ketschke, 1978)

DESCRIPTION:

Vertical drum screens consist of a screen placed on a vertical revolving drum located across an intake opening in front of the pumps. A schematic of the vertical drum screen is depicted below. Water passes through the screens, and debris is washed from the screens by vertical jet sprays placed inside the drums. This arrangement operates well under conditions of fluctuating water levels. In theory, submerged water jets would clean the screen during rotation; however, without a strong flushing current to carry removed organisms and debris, this material would simply reimpinge and jam in the sealing area between the screen and the support pier. This type of screen has limited use at water intakes and has not been developed for steam power plant application. The maximum flow rate that can be accommodated by a vertical drum screen is about 5,000 gallons per minute (EPA, 1976; ASCE, 1982).

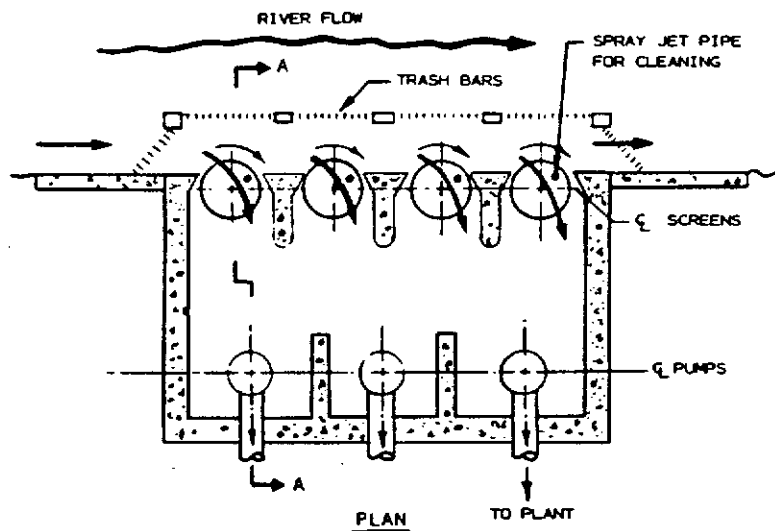

Vertical Drum Screen (EPA, 1976)

REFERENCES:

ASCE. Task Committee on Fish-handling of Intake Structures of the Committee of Hydraulic Structures. Design of Water Intake Structures for Fish Protection. American Society of Civil Engineers. New York, NY. 1982.

Mikels, F.C., and T.W. Bennett. "Cooling Water Intakes Utilizing Ranney Collectors or Ranney Intakes." In Larval Exclusion Systems For Power Plant Cooling Water Intakes. San Diego, CA. February 1978. pp. 15-25.

Mussalli, Y.G., E.P. Taft III, and J. Larsen. "Offshore Water Intakes Designated to Protect Fish." Journal of the Hydraulics Division. Proceedings of the American Society of Civil Engineers, Vol. 106, No Hy11. November 1980. pp. 1885-1901.

Richards, R.T. "Engineering Considerations in the Use of Artificial Filter Beds." In Larval Exclusion Systems for Power Plant Cooling Water Intakes. San Diego, CA. February 1978. pp. 5-12.

Sharma, R.K. "A Synthesis of Views Presented at the Workshop." In Larval Exclusion Systems for Power Plant Cooling Water Intakes. San Diego, CA. February 1978. pp. 235-237.

TESTING FACILITIES AND/OR FACILITIES USING THE TECHNOLOGY:

- Vertical drum screens are not used at U.S. steam power plants. However, they are used for fish diversion in irrigation canals and in British steam electric stations for protection of salmonids with variable success (Eicher, 1974).

RESEARCH/OPERATION FINDINGS:

- Since larger types of vertical drum screens have not been developed, their reliability is unknown (ASCE, 1982).

DESIGN CONSIDERATIONS:

- None found.

ADVANTAGES:

- Water level variations can be handled without difficulty.

LIMITATIONS:

- Vertical drum screens are limited to low flow situations. The technology requires a strong flushing current (such as a passing river flow) to carry removed organisms and debris away from the intake.

REFERENCES:

ASCE. Design of Water Intake Structures for Fish Protection. American Society of Civil Engineers. New York, NY. 1982.

Eicher, G.J. "Adaptation of Hydro Fish Facilities to Steam-Electric Stations." In Second Workshop on Entrainment and Intake Screening. Electric Power Research Institute, RP-49. 1974. pp. 199-203.

U.S. EPA. Development Document for Best Technology Available for the Location, Design, Construction, and Capacity of Cooling Water Intake Structures for Minimizing Adverse Environmental Impact. U.S. Environmental Protection Agency, Effluent Guidelines Division, Office of Water and Hazardous Materials. April 1976.

TESTING FACILITIES AND/OR FACILITIES USING THE TECHNOLOGY:

- Radial wells have been in use for over 40 years and have served successfully when properly located and designed. In 1978, it was estimated that there were more than 300 Ranney Collectors in operation in the United States and Europe. About 55 percent of these were used for municipal water supplies, while the remaining 45 percent were employed for industrial processes and cooling water supplies (Mikels, 1978).

RESEARCH/OPERATION FINDINGS:

- Radial wells offer maximum protection to aquatic organisms of all sizes (ASCE, 1982).

DESIGN CONSIDERATIONS:

- The aquifer must be of a suitably porous material.
- The maximum capacity of a single well is limited to about 25,000 gallons per minute.
- Geological and hydrological considerations are critical in the siting and installation of these wells because the substrate must have adequate permeability to allow for the flow from the source water body to the subsurface collector.
- Collector caisson spacing for multiple radial well units is typically 1,500 feet. The typical diameter of radial collector screens is 8 to 16 inches (ASCE, 1982).

ADVANTAGES:

- The concept is reliable in design and operation and is relatively maintenance free.
- The wells are suitable for use at freshwater, estuarine, and coastal locations. If economic factors permit, the wells should be preferable to all other control systems for larval screening (Sharma, 1978).
- Larval exclusion is maximized in radial wells; no impingement or entrainment impacts are associated with this system since water is withdrawn from underground.

LIMITATIONS:

- Radial wells are only suitable where there is a porous aquifer with the capacity to provide the quantity of water required for such systems.
- The individual caisson units are limited to about 25,000 gallons per minute in a favorable aquifer, which limits application of such wells for large volume once-through cooling intakes.

DESCRIPTION:

A rotating disk screen consists of a rotating disk covered by mesh that is installed at right angles to the water channel. A rotating disk screen is depicted in the figure below. The disk rotates around a horizontal axis, bringing the dirty screen face above water where high-pressure sprays wash the debris into a trough. Much of the debris may fall off and remain in the waterway, thus reducing the efficiency of the screen for debris removal. No more than 35 percent of the total screen face is used at any one time. This screen is only suitable for relatively small flows and small water level variations. The rotating disk screen has no advantage over other common screens for fish protection (EPA, 1976; ASCE, 1982).

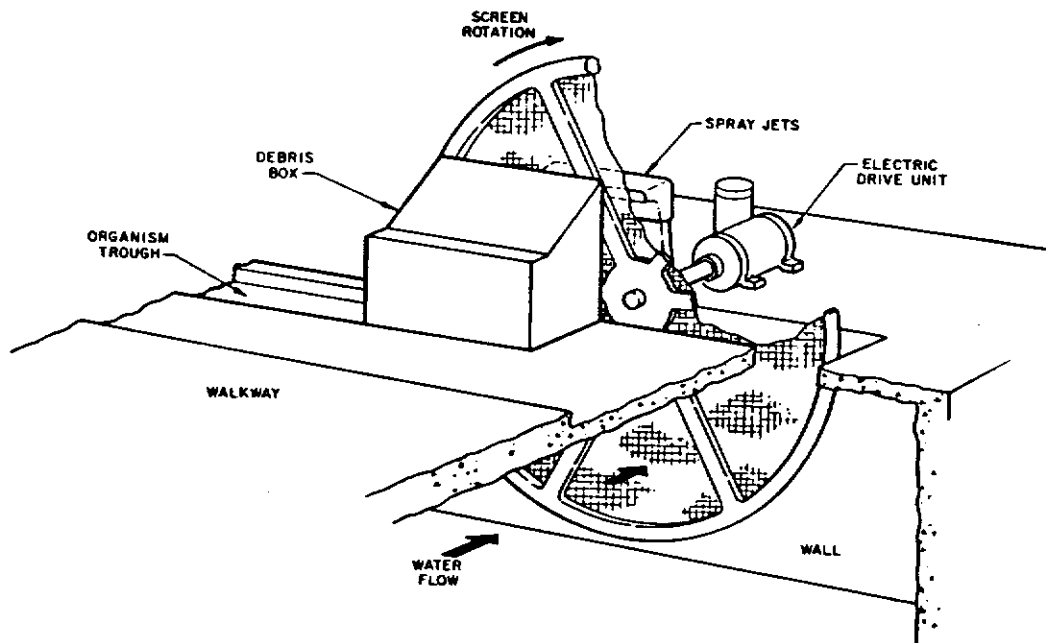

Rotating Disk Screen (ASCE, 1982)

DESCRIPTION:

The radial well is a horizontal version of a vertical water well drawing water from a surrounding aquifer. Such wells are developed in the same manner as conventional wells. The intake consists of a vertical pump caisson, which is sunk below the water table. Several perforated collector screen pipes (radial collectors) are then jacked out through wall ports into the surrounding porous aquifer as depicted in the figure below (Richards, 1978). The radial well intake, long represented by the Ranney Collector, has a long history of successful performance. This system offers maximum protection to aquatic organisms of all sizes, but is only suitable where there is a porous aquifer. In addition, the associated costs of pumps and a large piping network limit the radial well for once-through application (Mussalli et al., 1980).

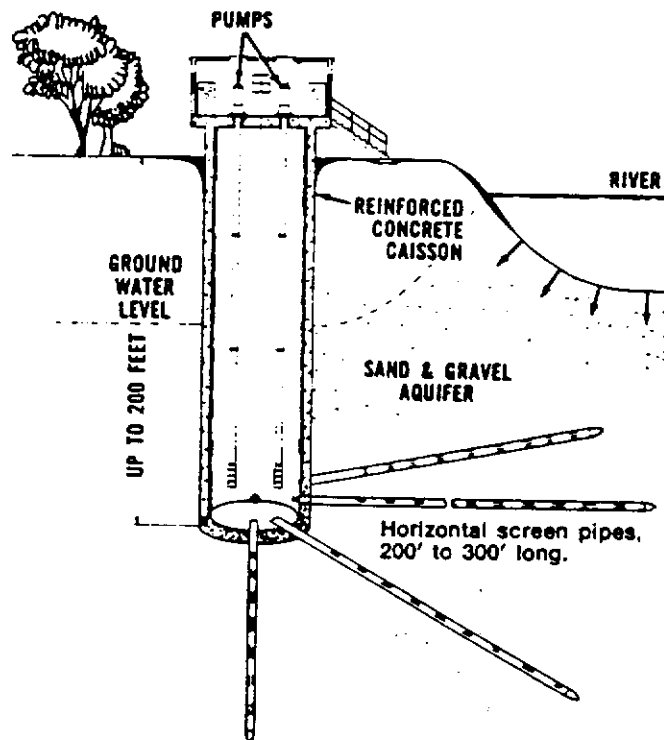

Radial Well Intake (Richards, 1978)
(Ranney Collector)

TESTING FACILITIES AND/OR FACILITIES USING THE TECHNOLOGY:

- Rotating disk screens are not used at U.S. steam power plants.

RESEARCH/OPERATION FINDINGS:

- None found.

DESIGN CONSIDERATIONS:

- None found.

ADVANTAGES:

- The rotating disk screen has few moving parts and is inexpensive to buy and maintain.

LIMITATIONS:

- Rotating disk screens have a high probability of fish impingement; require high pressure sprays to remove fish and debris; and require a very large screen structure to reduce screen approach velocities.
- The screen is limited to relatively low water flows.

REFERENCES:

ASCE. Task Committee on Fish-handling of Intake Structures of the Committee of Hydraulic Structures. Design of Water Intake Structures for Fish Protection. American Society of Civil Engineers. New York, NY. 1982.

U.S. EPA. Development Document for Best Technology Available for the Location, Design, Construction, and Capacity of Cooling Water Intake Structures for Minimizing Adverse Environmental Impact. U.S. Environmental Protection Agency, Effluent Guidelines Division, Office of Water and Hazardous Materials. April 1976.

DESIGN CONSIDERATIONS:

- The design of these systems is fairly well established for various water intakes (ASCE, 1982).

ADVANTAGES:

- The primary advantage is the absence of a confined channel in which fish might become trapped.

LIMITATIONS:

- Clogging, frazil ice formation, biofouling, and removal of debris limit this technology to small flow withdrawals.

REFERENCES:

ASCE. Task Committee on Fish-handling of Intake Structures of the Committee of Hydraulic Structures. Design of Water Intake Structures for Fish Protection. American Society of Civil Engineers. New York, NY. 1982.

EI Power Statistics Database. Prepared by the Utility Data Institute for the Edison Electric Institute. Washington, DC. 1993.

Richards, R.T. 1977. "Present Engineering Limitations to the Protection of Fish at Water Intakes." In Fourth National Workshop on Entrainment and Impingement, L.D. Jensen (Editor). Chicago, IL. December 1977. pp. 415-424.

Sharma, R.K. "A Synthesis of Views Presented at the Workshop." In Larval Exclusion Systems for Power Plant Cooling Water Intakes. San Diego, CA. February 1978. pp. 235-237.

INTAKE SCREENING SYSTEMS**FACT SHEET NO. 11****FIXED SCREENS****DESCRIPTION:**

A fixed screen system typically consists of two sets of screens vertically installed prior to the intake pumps. These screens, generally mounted in a frame, are installed in vertical tracks on the intake channel walls and lifted out of the water for cleaning. At least one set of back-up screens is in position at all times (Ray et al., 1976). Fixed screens are primarily used at intakes where suspended debris is negligible, resulting in minimal cleaning requirements (EPA, 1976).

TESTING FACILITIES AND/OR FACILITIES USING THE TECHNOLOGY:

- Forty-six steam electric units are using fixed screens as their primary water screening device (EEI, 1993). The intake flow associated with these units is relatively low ranging from 1 to 30 MGD. The combined total intake flow of all these units (once-through and closed cycle) is 440 MGD.

RESEARCH/OPERATION FINDINGS:

- None found.

DESIGN CONSIDERATIONS:

- None found.

ADVANTAGES:

- None found.

LIMITATIONS:

- Operators must be available at all times to maintain the screens.
- Long impingement times between cleaning periods result in total mortality of fish.
- There is a possibility that a heavy load of debris or fish could completely clog the intake and cause plant shutdown and/or screen collapse (Ray et al., 1976).

REFERENCES:

EEI Power Statistics Database. Prepared by the Utility Data Institute for the Edison Electric Institute. Washington, D.C. 1993.

Ray, S.S., R.L. Snipes, and D.A. Tomljanovitch, A State-of-the-Art Report on Intake Technologies. Prepared for the Office of Energy, Minerals, and Industry, Office of Research and Development, U.S. Environmental Protection Agency, Washington D.C. by the Tennessee Valley Authority. EPA 600/7-76-020. October 1976.

DESCRIPTION:

Perforated pipes draw water through perforations or slots in a cylindrical section placed in the waterway. The term "perforated" is applied to round perforations and elongated slots as shown in the figure below. The early technology was not efficient, velocity distribution was poor, and fish protection was not considered (ASCE, 1982). Inner sleeves have been added to perforated pipes to equalize the velocities entering the outer perforations. Water entering a single perforated pipe intake without an inner sleeve will have a wide range of entrance velocities with the highest velocity concentrated at the supply pipe end. These systems have been used at locations requiring small amounts of water such as make-up water. However, experience at steam electric plants is very limited (Sharma, 1978).

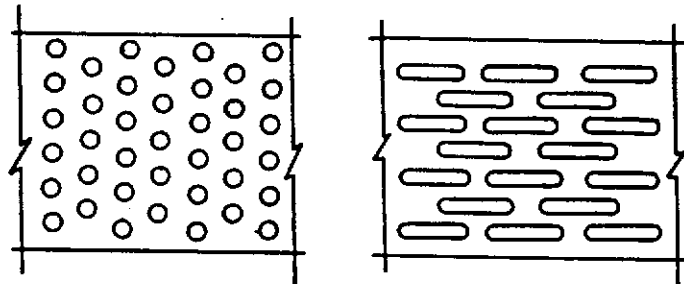

Perforations and Slots in Perforated Pipe (ASCE, 1982)

TESTING FACILITIES AND/OR FACILITIES USING THE TECHNOLOGY:

- Nine steam electric units in the United States use perforated pipes. Each of these units has closed-cycle cooling systems with relatively low make-up intake flow ranging from 7 to 36 MGD (EEL, 1993).

RESEARCH/OPERATION FINDINGS:

- Maintenance of perforated pipe systems requires control of biofouling and removal of debris from clogged screens.
- For withdrawal of relatively small quantities of water, up to 50,000 gpm, the perforated pipe inlet with an internal perforated sleeve offers substantial protection for fish. This particular design serves the Washington Public Power Supply System on the Columbia River (Richards, 1977).
- No information is available on the fate of the organisms impinged at the face of perforated pipes.

U.S. EPA. Development Document for Best Technology Available for the Location, Design, Construction, and Capacity of Cooling Water Intake Structures for Minimizing Adverse Environmental Impact. U.S. Environmental Protection Agency, Effluent Guidelines Division, Office of Water and Hazardous Materials. April 1976.

- Because of these limitations, wedge-wire screens are more suitable for closed-cycle make-up intakes than once-through systems. Closed-cycle systems require less flow and fewer screens than once-through intakes; back-up screens can therefore be used during maintenance work on the wedge-wire screens (Mussalli et al., 1980).

REFERENCES:

Delmarva Ecological Laboratory. Ecological Studies of the Nanticoke River and Nearby Area. Vol II. Profile Wire Studies. Report to Delmarva Power and Light Company. 1980.

EEL Power Statistics Database. Prepared by the Utility Data Institute for the Edison Electric Institute. Washington, DC. 1993.

Hanson, B.N., W.H. Bason, B.E. Beitz, and K.E. Charles. "A Practical Intake Screen Which Substantially Reduces the Entrainment and Impingement of Early Life Stages of Fish." In Fourth National Workshop on Entrainment and Impingement. L.D. Jensen (Editor). Ecological Analysts, Inc., Melville, NY. Chicago, IL. December 1977. pp. 393-407.

Heuer, J.H., and D.A. Tomljanovitch. "A Study on the Protection of Fish Larvae at Water Intakes Using Wedge-Wire Screening." In Larval Exclusion Systems for Power Plant Cooling Water Intakes. R.K. Sharrow and J.B. Palmer (Editors). Argonne National Lab. Argonne, IL. February 1978. pp. 169-194.

Lifton, W.S. "Biological Aspects of Screen Testing on the St. Johns River, Palatka, Florida." In Passive Screen Intake Workshop, Johnson Division UOP Inc. St. Paul, MN. 1979.

Mussalli, Y.G., E.P. Taft III, and J. Larsen. "Offshore Water Intakes Designated to Protect Fish." Journal of the Hydraulics Division, Proceedings of the American Society of Civil Engineers. Vol. 106, No HY11. November 1980. pp. 1885-1901.

Pagano R., and W.H.B. Smith. Recent Developments in Techniques to Protect Aquatic Organisms at the Water Intakes of Steam-Electric Power Plants. MITRE Technical Report 7671. November 1977.

Weisberg, S.B., F. Jacobs, W.H. Burton, and R.N. Ross. Report on Preliminary Studies Using the Wedge Wire Screen Model Intake Facility. Prepared for State of Maryland, Power Plant Siting Program. Prepared by Martin Marietta Environmental Center. Baltimore, MD. 1983.

Weisberg, S.B., W.H. Burton, E.A. Ross, and F. Jacobs. The Effects of Screen Slot Size, Screen Diameter, and Through-Slot Velocity on Entrainment of Estuarine Ichthyoplankton Through Wedge-Wire Screens. Martin Marietta Environmental Studies. Columbia, MD. August 1984.

DESCRIPTION:

Wedge-wire screens, also called profile screens or Johnson screens, are designed to reduce entrainment by physical exclusion and by exploiting hydrodynamics. The screen is composed of wedge-wire loops welded at the apex of their triangular cross section to supporting axial rods. The base of the cross section is presented to the incoming flow (Pagano et al., 1977). Physical exclusion occurs when the mesh size of the screen is smaller than the organisms susceptible to entrainment. Hydrodynamic exclusion results from maintenance of a low through-slot velocity which, because of the screen's cylindrical configuration, is quickly dissipated, thereby allowing organisms to escape the flow field (Weisberd et al., 1984). The screens are usually fine mesh (0.5-1 mm). A cylindrical wedge-wire screen is shown in the figure below. Wedge-wire screens are more suitable for closed-loop make-up intakes than for once-through systems.

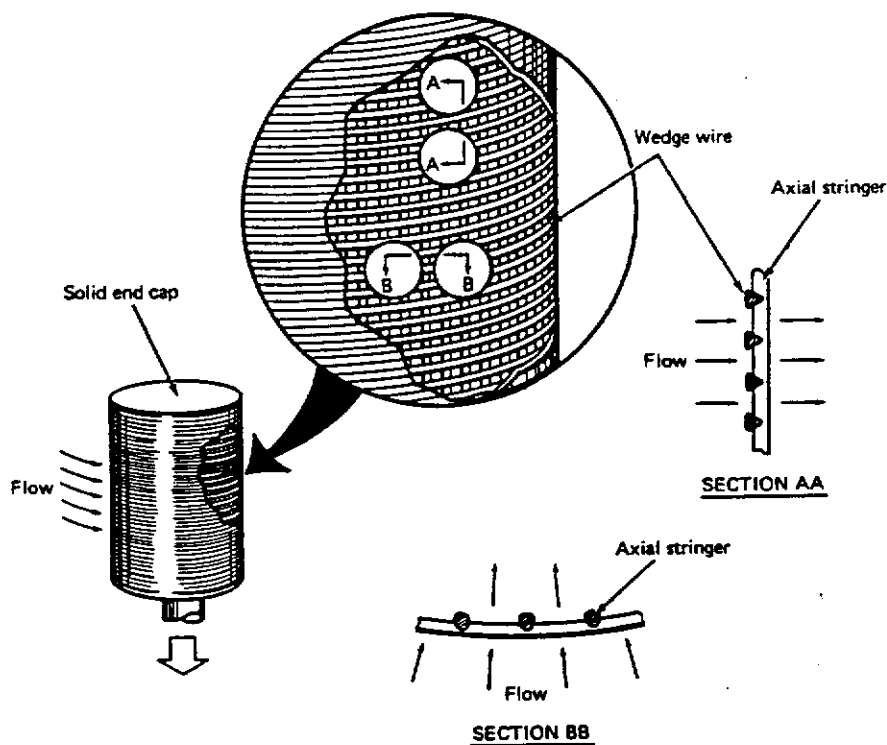

Schematic of Cylindrical Wedge-Wire Screen (Pagano et al., 1977)

TESTING FACILITIES AND/OR FACILITIES USING THE TECHNOLOGY:

Five U.S. steam electric units use wedge-wire screens as their primary screening devices. All of these units have a closed-cycle cooling system with intake flows ranging from 8 to 32 MGD (EEL, 1993).

RESEARCH/OPERATION FINDINGS:

- In situ observations have shown that impingement is virtually eliminated when wedge-wire screens are used (Hanson, 1977; Weisberg et al., 1984).
- Laboratory studies (Heuer and Tomljanovitch, 1978) and prototype field studies (Lifton, 1979; Delmarva Power and Light, 1982; Weisberg et al., 1983) have shown that fine mesh wedge-wire screens also reduce entrainment.
- One study (Hanson, 1977) found that entrainment of fish eggs (striped bass), ranging in diameter from 1.8 mm to 3.2 mm, could be eliminated with a cylindrical wedge-wire screen incorporating 0.5 mm slot openings. However, 75 percent of striped bass larvae, measuring 5.2 mm to 9.2 mm, were generally entrained through a 1 mm slot within 1 minute of release in the test flume.

DESIGN CONSIDERATIONS:

- To minimize clogging, the screen should be located in an ambient current of at least 1 foot per second (ft/sec).
- A uniform velocity distribution along the screen face is required to minimize the entrapment of motile organisms and to minimize the need for debris backflushing.
- In northern latitudes, provisions for the prevention of frazil ice formation on the screens must be considered.
- Allowance should be provided below the screens for silt accumulation to avoid blockage of the water flow (Mussalli et al., 1980).

ADVANTAGES:

- Wedge-wire screens have been demonstrated to reduce impingement and entrainment in laboratory and prototype field studies.

LIMITATIONS:

- The physical size of the screening device is limiting in most passive systems; thus, many clusters of screening units are necessary to handle higher flow rates.
- Siltation, biofouling, and frazil ice limit areas where passive screens such as wedge-wire can be utilized.