



March 31, 2019

Michael Montgomery, Executive Officer
California Regional Water Quality Control Board, San Francisco Bay Region
1515 Clay Street, Suite 1400
Oakland, CA 94612

Patrick Pulupa, Esq., Executive Officer
California Regional Water Quality Control Board, Central Valley Region
11020 Sun Center Drive, #200
Rancho Cordova, CA 95670-6114

**SUBJECT: Submittal of Urban Creeks Monitoring Report in Accordance with
MRP 2.0 Permit Provision C.8.h.iii and Central Valley Permit Provision C.8.g.iii**

Dear Messrs. Montgomery and Palupa:

Attached please find the Water Year 2018 Urban Creeks Monitoring Report (UCMR) submitted on behalf of all Contra Costa Permittees per the Municipal Regional Permit (MRP) for urban stormwater issued by the San Francisco Bay Regional Water Quality Control Board (SFRWQCB; Order No. R2-2015-0049; "MRP 2.0") and the East Contra Costa County Municipal NPDES Permit (Central Valley Permit) issued by the Central Valley Regional Water Quality Control Board (CVRWQCB; Order No. R5-2010-0102).

With the approval and direction from duly authorized representative of each Permittee, I am authorized to submit and certify under penalty of law that this document and all attachments were prepared under my direction or supervision in accordance with a system designed to assure that qualified personnel properly gathered and evaluated the information submitted. Based on my inquiry of the person or persons who manage the system, or those persons directly responsible for gathering the information, the information submitted is, to the best of my knowledge and belief, true, accurate, and complete. I am aware that there are significant penalties for submitting false information, including the possibility of fine and imprisonment for knowing violations.

Regards,

A handwritten signature in blue ink that reads "Courtney Riddle".

Courtney Riddle, Program Manager
Contra Costa Clean Water Program

cc: Thomas Mumley, SFBRWQCB
Keith Lichten, SFBRWQCB
Dale Bowyer, SFBRWQCB
Janet O'Hara, SFBRWQCB
Kevin Lunde, SFBRWQCB
Zack Rokeach, SFRWQCB
Elizabeth Lee, CVRWQCB

G:\NPDES\Management Committee\Packet\18 19\Shells\Lucile\2019-03\Action Item A - Attach UCMR Transmittal Letter_v2.docx



CONTRA COSTA
CLEAN WATER
PROGRAM

***Urban Creeks Monitoring Report:
Water Year 2018
(October 2017 – September 2018)***



***Submitted to the San Francisco Bay and
Central Valley Regional Water Quality Control Boards
in Compliance with NPDES Permit
Provisions C.8.h.iii and C.8.g.iii***

NPDES Permit Nos. CAS612008 and CAS083313

March 27, 2019

***A Program of Contra Costa County, its Incorporated Cities and Towns,
and the Contra Costa Flood Control & Water Conservation District***

This page intentionally blank

Contra Costa Clean Water Program

Urban Creeks Monitoring Report: Water Year 2018 (October 2017 – September 2018)

March 27, 2019

Prepared for

Contra Costa Clean Water Program
255 Glacier Drive
Martinez, California 94553

Contra Costa Clean Water Program Participants

- Cities of Antioch, Brentwood, Clayton, Concord, Danville (Town), El Cerrito, Hercules, Lafayette, Martinez, Moraga (Town), Oakley, Orinda, Pinole, Pittsburg, Pleasant Hill, Richmond, San Pablo, San Ramon, and Walnut Creek
- Unincorporated Contra Costa County
- Contra Costa County Flood Control & Water Conservation District

Prepared by

ADH Environmental
3065 Porter Street, Suite 101
Soquel, California 95073

In association with

Wood Environment & Infrastructure Solutions, Inc.
180 Grand Avenue, Suite 1100
Oakland, California 94612

and

Armand Ruby Consulting
P.O. Box 945
Capitola, California 95010

This page intentionally blank

Table of Contents

List of Acronyms and Abbreviations	iii
Preface	vii
1 Introduction	1
1.1 Regional Monitoring Coalition (RMC) Overview	3
1.2 Coordination of Third Party Monitoring (C.8.a)	4
1.3 Monitoring Protocols and Data Quality (C.8.b)	5
1.3.1 Standard Operating and Data Quality Assurance Procedures	5
1.3.2 Information Management System Development/Adaptation	5
2 San Francisco Estuary Receiving Water Monitoring (C.8.c)	7
2.1 RMP Pilot and Special Studies	7
2.2 RMP Status and Trends Monitoring Program	8
2.3 Participation in Committees, Workgroups and Strategy Teams	8
3 Creek Status Monitoring (C.8.d)	9
3.1 Regional/Probabilistic Monitoring	10
3.2 Local/Targeted Monitoring	11
3.3 Pesticides and Toxicity Monitoring (C.8.g)	11
3.3.1 Toxicity in Water Column – Dry Weather (C.8.g.i)	12
3.3.2 Toxicity, Pesticides and Other Pollutants in Sediment – Dry Weather (C.8.g.ii)	12
3.3.3 Wet Weather Pesticides and Toxicity Monitoring – Wet Weather (C.8.g.iii)	12
4 Stressor/Source Identification Projects (C.8.e)	13
4.1 Marsh Creek SSID Study – Year 1 Status Report	13
5 Pollutants of Concern Monitoring (C.8.f)	15
6 References	17

Appendices

Appendix 1:	Regional/Probabilistic Creek Status Monitoring Report: Water Year 2018
Appendix 2:	Local/Targeted Creek Status Monitoring Report: Water Year 2018
Appendix 3:	BASMAA Regional Monitoring Coalition
	A. Regional Stressor/Source Identification (SSID) Report, MRP 2.0 SSID Project Locations, Rationales and Status
	B. PCBs from Electrical Utilities in San Francisco Bay Area Watersheds, Stressor/Source Identification (SSID), Project Work Plan
Appendix 4:	Marsh Creek Stressor and Source Identification Study, Year 1 Status Report
Appendix 5:	Pollutants of Concern Monitoring Report: Water Year 2018 Sampling and Analysis
Appendix 6:	POC Monitoring for Management Action Effectiveness
	A. Pollutant Removal from Stormwater with Biochar Amended Bioretention Soil Media (BSM) Project Report
	B. Evaluation of Mercury and PCBs Removal Effectiveness of Full Trash Capture Hydrodynamic Separator Units, Project Report
Appendix 7:	Regional Monitoring Program Pollutants of Concern Reconnaissance Monitoring Progress Report, WY 2015-2018
Appendix 8:	BASMAA RMC Five-Year Bioassessment Report

List of Tables

Table i. Summary Table of Water Year 2018 Creek Status Monitoring Stations v
Table 1. Regional Monitoring Coalition Participants..... 3
Table 2. Creek Status Monitoring Parameters Sampled in Compliance with MRP Provisions C.8.d.
and C.8.g. as Either Regional/Probabilistic or Local/Targeted Parameters..... 10

List of Figures

Figure i. BASMAA Regional Monitoring Coalition Area, County Boundaries and Major Creeksviii
Figure 1. Creek Status, Pollutants of Concern, Pesticides and Toxicity, and Stressor/Source
Identification Monitoring Stations in WY 2018 2

List of Acronyms and Abbreviations

ACCWP	Alameda Countywide Clean Water Program
BASMAA	Bay Area Stormwater Management Agencies Association
CCCWP	Contra Costa Clean Water Program
CEDEN	California Environmental Data Exchange Network
CSCI	California Stream Condition Index
CVRWQCB	Central Valley Regional Water Quality Control Board
FSURMP	Fairfield-Suisun Urban Runoff Management Program
NPDES	National Pollutant Discharge Elimination System
PHab	physical habitat
POC	pollutants of concern
P/S Studies	Pilot and Special Studies
QAPP	quality assurance project plan
RMC	Regional Monitoring Coalition
RWQCB	Regional Water Quality Control Board
S&T Program	Status & Trends Monitoring Program
SCVURPPP	Santa Clara Valley Urban Runoff Pollution Prevention Program
SFBRWQCB	San Francisco Bay Regional Water Quality Control Board
SMCWPPP	San Mateo Countywide Water Pollution Prevention Program
SSID	stressor/source identification
SPoT	Stream Pollution Trends
SWAMP	California Surface Water Ambient Monitoring Program
WY	water year

This page intentionally blank

Table i. Summary Table of Water Year 2018 Creek Status Monitoring Stations

Site ID	Creek Name	Latitude	Longitude	Bioassessment PHab Chlorine Nutrients	Stormwater Toxicity and Chemistry (Wet Weather)	Water Toxicity and Sediment Toxicity and Chemistry (Dry Weather)	Temperature	Continuous Water Quality	Pathogen Indicator Bacteria
204R02068	South San Ramon Creek	37.74792	-121.94346	X					
206R01495	Pinole Creek	37.97919	-122.26354	X			X		
206R02203	Lauterwusser Creek	37.89550	-122.19260	X					
206R02343	Wildcat Creek	37.96171	-122.35447	X					X
207R01600	Mt. Diablo Creek	38.01669	-122.02438	X					
207R01899	Mitchell Creek	37.94118	-121.93701	X					
207R02315	Grayson Creek	37.97958	-122.06860	X					
207R04027	Pine Creek	37.89318	-121.99378	X					
544R01737	Marsh Creek	37.96267	-121.68748	X		X			
544R01993	Marsh Creek	37.93229	-121.71109	X					
204R01412	West Branch Alamo Creek	37.78499	-121.92294		X				
544R04613	Marsh Creek	37.99031	-121.69585		X				
207ALH015	Alhambra Creek	38.01490	-122.13257				X		
207ALH110	Alhambra Creek	38.00346	-122.12968				X		
206SPA125	San Pablo Creek	37.96621	-122.29918				X	X	
207WAL025	Grayson Creek	37.99699	-122.06491						X
207WAL411	Las Trampas Creek	37.86159	-122.10146					X ¹	
206R00727	Pinole Creek	37.97961	-122.26835						X
207R01675	Sans Crainte Creek	37.87644	-122.02348						X
207R02891	Las Trampas Creek	37.88692	-122.09717					X ²	
206R03927	San Pablo Creek	37.96480	-122.32364						X

- 1 Location of spring deployment in Las Trampas Creek
- 2 Location of summer deployment in Las Trampas Creek

This page intentionally blank

Preface

Contra Costa County lies within both the Region 2 and Region 5 jurisdictions of the State Water Resources Control Board (Figure i). The countywide stormwater program is subject to both the Region 2 municipal regional stormwater National Pollutant Discharge Elimination System (NPDES) permit (MRP)¹ and the equivalent Region 5 permit².

This urban creeks monitoring report complies with MRP provision C.8.h.iii for reporting of all data in water year 2018 (October 1, 2017-September 30, 2018). Data were collected pursuant to provision C.8 of the MRP. Data presented in this report were produced under the direction of the Regional Monitoring Coalition (RMC) and the Contra Costa County Clean Water Program (CCCWP) using regional/probabilistic and local/targeted monitoring designs as described herein.

In early 2010, several members of the Bay Area Stormwater Management Agencies Association (BASMAA) joined together to form the RMC to coordinate and oversee water quality monitoring required by the MRP. The RMC includes the following stormwater program participants:

- Alameda Countywide Clean Water Program
- Contra Costa Clean Water Program
- San Mateo Countywide Water Pollution Prevention Program
- Santa Clara Valley Urban Runoff Pollution Prevention Program
- Fairfield-Suisun Urban Runoff Management Program
- City of Vallejo and Vallejo Sanitation and Flood Control District

In accordance with the BASMAA RMC multi-year work plan (Work Plan) (BASMAA, 2011) and the creek status and long-term trends monitoring plan (BASMAA, 2012), monitoring data were collected in accordance with the BASMAA RMC quality assurance project plan (QAPP) (BASMAA, 2016a) and the BASMAA RMC standard operating procedures (SOPs) (BASMAA, 2016b). Where applicable, monitoring data were derived using methods comparable with methods specified by the California Surface Water Ambient Monitoring Program (SWAMP) QAPP³. Data presented in this report were also submitted in electronic SWAMP-comparable formats to the San Francisco Estuary Institute for transmittal to the Regional Water Quality Control Board on behalf of the CCCWP permittees and pursuant to the MRP provision C.8.h.ii requirements for electronic data reporting.

¹ The San Francisco Bay Regional Water Quality Control Board (SFBRWQCB) issued the MRP to 76 cities, counties and flood control districts (i.e., the permittees) in the Bay Area on October 14, 2009 (SFBRWQCB, 2009). On November 19, 2015, SFBRWQCB issued Order No. R2-2015-0049. This amendment supersedes and rescinds Order Nos. R2-2009-0074 and R2-2011-0083, and became effective January 1, 2016. The BASMAA programs supporting MRP regional projects include all MRP permittees, as well as the cities of Antioch, Brentwood and Oakley, which are not named as permittees under the MRP, but have voluntarily elected to participate in MRP-related regional activities.

² The Central Valley Regional Water Quality Control Board (CVRWQCB) issued the East Contra Costa County Municipal NPDES Permit (Order No. R5-2010-0102) on September 23, 2010 (CVRWQCB, 2010).

³ The current SWAMP QAPP is available at:

http://www.waterboards.ca.gov/water_issues/programs/swamp/docs/qapp/swamp_qapp_master090108a.pdf

Figure i. BASMAA Regional Monitoring Coalition Area, County Boundaries and Major Creeks

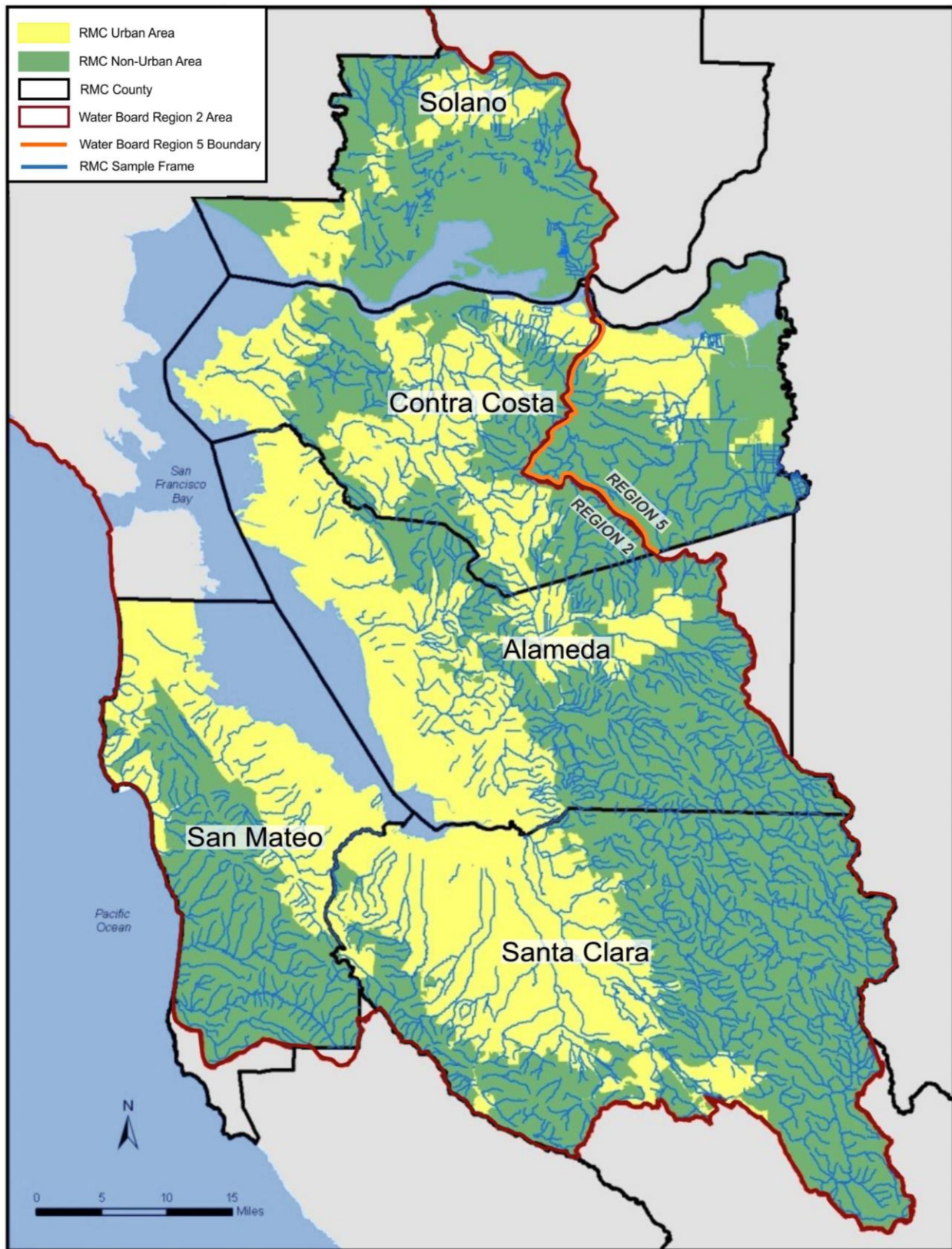

1 Introduction

This urban creeks monitoring report was prepared by the Contra Costa Clean Water Program (CCCWP) on behalf of its 21 member agencies (19 cities/towns, County of Contra Costa, and Contra Costa County Flood Control and Water Conservation District) in accordance with the requirements of the Municipal Regional Permit (MRP) for urban stormwater issued by the San Francisco Bay Regional Water Quality Control Board (SFBRWQCB) (Order No. R2-2015-0049) and the East Contra Costa County Municipal National Pollutant Discharge Elimination System (NPDES) Permit (Central Valley Permit) issued by the Central Valley Regional Water Quality Control Board (CVRWQCB) (Order No. R5-2010-0102).

This report, including all appendices and attachments, fulfills the requirements of MRP provision C.8.h.iii and Central Valley Permit provision C.8.g.iii for interpreting and reporting monitoring data collected during water year (WY) 2018 (October 1, 2017-September 30, 2018). All monitoring data presented in this report were submitted electronically to the Water Boards by CCCWP and may be obtained via the San Francisco Bay Area Regional Data Center (<http://www.sfei.org/sfeidata.htm>). Data collected from receiving waters may be obtained via the California Environmental Data Exchange Network (CEDEN) (<http://www.ceden.org>).

This report is organized by the sub-provisions of MRP provision C.8, as follows:

1. Introduction (MRP provision C.8.a)
2. Monitoring Protocols and Data Quality (MRP provision C.8.b)
3. San Francisco Estuary Receiving Water Monitoring (MRP provision C.8.c)
4. Creek Status Monitoring (MRP provision C.8.d) and Pesticides and Toxicity Monitoring (MRP provision C.8.g) (Appendices 1 and 2)
5. Stressor/Source Identification Projects (MRP provision C.8.e) (Appendix 3)
6. Marsh Creek Stressor and Source Identification Study – Year 1 Status Report (MRP provision C.8.e) (Appendix 4)
7. Pollutants of Concern Monitoring (MRP provision C.8.f) (Appendices 5, 6 and 7)

Figure 1 maps the locations of CCCWP monitoring stations associated with provision C.8 compliance in WY 2018, including creek status, pesticides and toxicity, pollutants of concern (POC), and the Marsh Creek stressor/source identification (SSID) study.

Monitoring discussed herein was performed in accordance with the requirements of the Central Valley Permit and MRP. Key technical findings are summarized below and presented in more detail in the body of the report and in the respective appendices. The detailed methods and results associated with these report sections are also provided in the appendices to this report, as referenced within the applicable sections of the main body of this report.

Figure 1. Creek Status, Pollutants of Concern, Pesticides and Toxicity, and Stressor/Source Identification Monitoring Stations in WY 2018

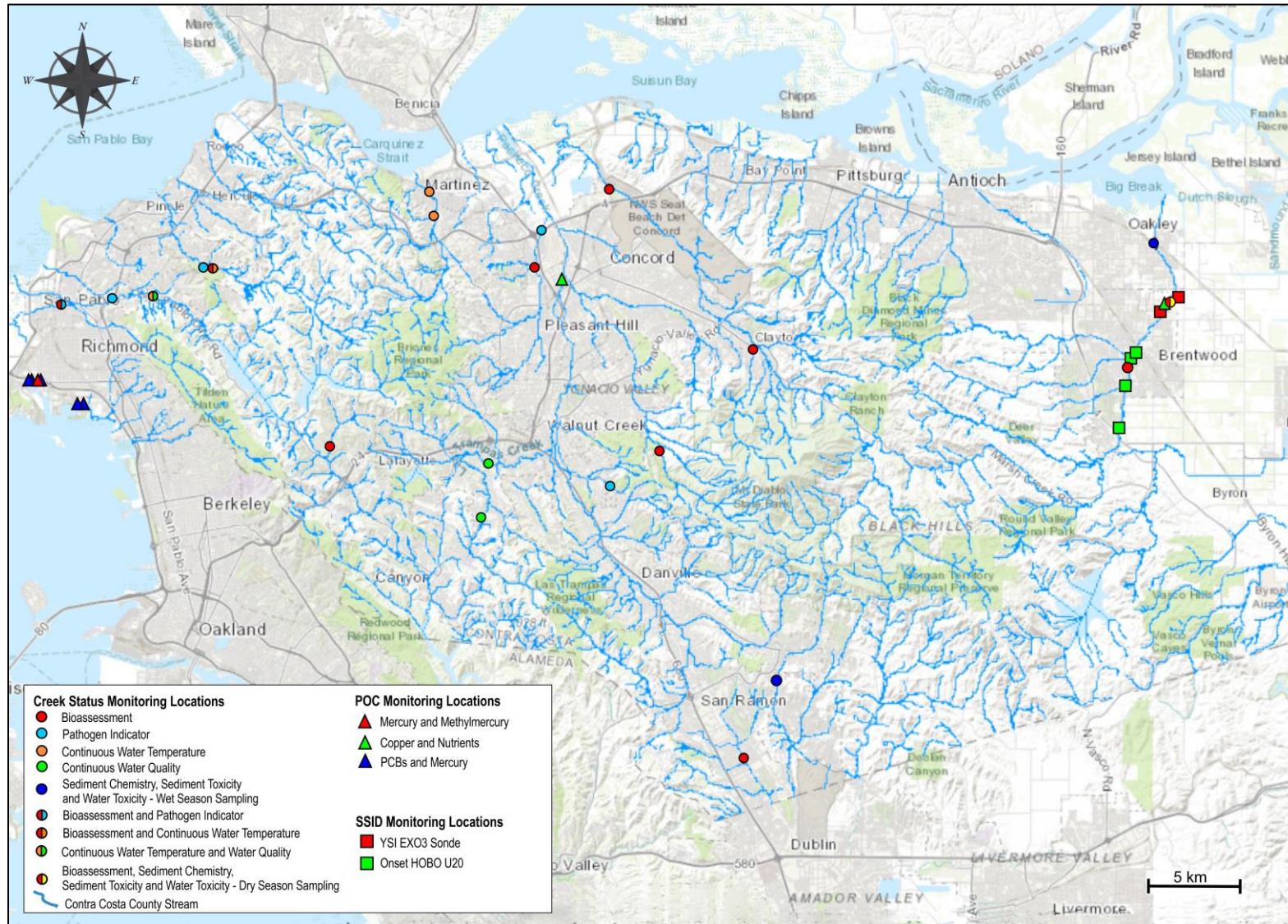

1.1 Regional Monitoring Coalition (RMC) Overview

Provision C.8.a. (Compliance Options) of the MRP allows the permittees to comply with all monitoring requirements by contributing to their county-wide Stormwater Program, through Regional Collaboration or by using data collected by a third-party.

In early 2010, CCCWP joined with several other members of the Bay Area Stormwater Management Agencies Association (BASMAA) to participate in a regional collaborative effort to coordinate water quality monitoring required by the MRP. BASMAA is a 501(c)(3) nonprofit organization comprised of the municipal stormwater programs in the San Francisco Bay Area. The resulting regional monitoring collaborative is called the BASMAA Regional Monitoring Coalition (RMC). Details of the of the respective RMC stormwater program participants and their co-permittees are presented in Table 1.

Table 1. Regional Monitoring Coalition Participants

Stormwater Programs	RMC Participants
Santa Clara Valley Urban Runoff Pollution Prevention Program (SCVURPPP)	Cities of Campbell, Cupertino, Los Altos, Milpitas, Monte Sereno, Mountain View, Palo Alto, San Jose, Santa Clara, Saratoga, Sunnyvale, Los Altos Hills, and Los Gatos; Santa Clara Valley Water District; and Santa Clara County
Alameda Countywide Clean Water Program (ACCWP)	Cities of Alameda, Albany, Berkeley, Dublin, Emeryville, Fremont, Hayward, Livermore, Newark, Oakland, Piedmont, Pleasanton, San Leandro, and Union City; Alameda County; Alameda County Flood Control and Water Conservation District; and Zone 7 Water Agency
Contra Costa Clean Water Program (CCCWP)	Cities/Towns of Antioch, Brentwood, Clayton, Concord, El Cerrito, Hercules, Lafayette, Martinez, Oakley, Orinda, Pinole, Pittsburg, Pleasant Hill, Richmond, San Pablo, San Ramon, Walnut Creek, Danville, and Moraga; Contra Costa County; and Contra Costa County Flood Control and Water Conservation District
San Mateo Countywide Water Pollution Prevention Program (SMCWPPP)	Cities and towns of Belmont, Brisbane, Burlingame, Daly City, East Palo Alto, Foster City, Half Moon Bay, Menlo Park, Millbrae, Pacifica, Redwood City, San Bruno, San Carlos, San Mateo, South San Francisco, Atherton, Colma, Hillsborough, Portola Valley, and Woodside; San Mateo County Flood Control District; and San Mateo County
Fairfield-Suisun Urban Runoff Management Program (FSURMP)	Cities of Fairfield and Suisun City
Vallejo Permittees	City of Vallejo and Vallejo Sanitation and Flood Control District

In June 2010, the permittees notified the Water Board in writing of their agreement to participate in the RMC to collaboratively address creek status and related monitoring requirements in MRP provision C.8. The RMC's goals are to:

- Assist permittees in complying with the requirements of MRP provision C.8 (Water Quality Monitoring)
- Develop and implement regionally consistent creek monitoring approaches and designs in the Bay Area through the improved coordination among RMC participants and other agencies such as the Regional Water Quality Control Board (RWQCB) that share common goals
- Stabilize the costs of creek monitoring by reducing duplication of effort and streamlining

In February 2011, the RMC developed a multi-year work plan (RMC Work Plan) to provide a framework for implementing regional monitoring and assessment activities required under MRP provision C.8. The RMC Work Plan summarized RMC-related projects planned for implementation between fiscal years 2009-2010 and 2014-2015. Projects were collectively developed by RMC representatives to the BASMAA Monitoring and Pollutants of Concern Committee (MPC) and were conceptually agreed to by the BASMAA Board of Directors. A total of 27 regional projects were identified in the RMC Work Plan, based on the requirements described in provision C.8 of the original (2009) MRP, most of which have continued with minor changes in the 2015 MRP. Regionally-implemented activities to provide standardization and coordination for the RMC Work Plan were conducted under the auspices of BASMAA. Scopes, budgets, and contracting implementation mechanisms for BASMAA regional projects follow BASMAA's Operational Policies and Procedures, approved by the BASMAA Board of Directors. MRP permittees, through their stormwater program representatives on the Board of Directors and its subcommittees, collaboratively authorize and participate in BASMAA regional projects or tasks. Regional project costs are shared by either all BASMAA members or among those Phase I municipal stormwater programs that are subject to the MRP. CCCWP and other RMC participants coordinate their monitoring activities through meetings and communications of the RMC Work Group and the MPC.

1.2 Coordination of Third Party Monitoring (C.8.a)

Provision C.8.a. (Compliance Options) of the MRP allows the permittees to comply with all monitoring requirements by contributing to their county-wide stormwater program, through regional collaboration or by using data collected by a third-party.

CCCWP works with third-party water quality monitoring partners to benefit local, regional and statewide monitoring efforts. Provision C.8.a.iii allows permittees to work with third-party organizations such as the SFBRWQCB, CVRWQCB, State Water Resources Control Board, or California Department of Pesticide Regulation (DPR) to fulfill monitoring requirements if data meets water quality objectives described in provision C.8.b. Monitoring locations in Contra Costa County are sampled as part of the state's Surface Water Ambient Monitoring Program (SWAMP) and assessed for pesticide pollution and toxicity through the Stream Pollution Trends (SPoT) Program. SPoT monitors status and trends in sediment toxicity and sediment contaminant concentrations in selected large rivers throughout California and relates contaminant concentrations and toxicity test results to watershed land uses.

CCCWP staff and other designated representatives participate with the Small Tributaries Loading Strategy (STLS) program of the Regional Monitoring Program for Water Quality in San Francisco Bay (RMP) to conduct pollutants of concern monitoring at Contra Costa sites, as further described in Section 5.

MRP permittees agreed to collectively conduct POC monitoring for management action effectiveness and for provision C.12.e compliance monitoring through BASMAA regional projects. The overall goal of monitoring was to 1) evaluate the effectiveness of selected stormwater treatment controls to provide information needed to support RAA development, and 2) investigate into PCB-containing caulks and sealants within storm drain and roadway infrastructure which added to the fulfillment of MRP provisions C.12.e. and C.8.f requirements. This work is further described in Section 5.

In addition, CCCWP supports efforts by local creek groups to monitor San Pablo, Wildcat, Walnut, Grayson, and Marsh Creek Watersheds.

1.3 Monitoring Protocols and Data Quality (C.8.b)

Provision C.8.b of the MRP and the Central Valley Permit requires water quality data collected by the permittees to comply with and be of a quality consistent with the State of California's SWAMP standards, set forth in the SWAMP quality assurance project plan (QAPP) and SOPs. RMC protocols and procedures were developed to assist permittees with meeting SWAMP data quality standards and to develop data management systems which allow for easy access to water quality monitoring data by permittees.

1.3.1 Standard Operating and Data Quality Assurance Procedures

For creek status monitoring, the RMC adapted existing SOPs and the QAPP developed by SWAMP to document the field procedures necessary to produce SWAMP-comparable, high quality data among RMC participants. The RMC creek status monitoring program QAPP and SOPs were updated to accommodate MRP 2.0 requirements in March 2016 (Version 3; BASMAA, 2016a and 2016b).

For POC monitoring, a draft sampling analysis plan (SAP) and QAPP were developed in 2016 to guide the monitoring efforts for each POC task. CCCWP's monitoring contractor implemented contracts with various laboratories for the analyses of all water and sediment samples.

Local agencies conduct quality assurance review of the data collected by RMC programs, consistent with the data quality objectives and protocols defined in the RMC QAPP and SOPs.

1.3.2 Information Management System Development/Adaptation

Permittees are required to report annually on water quality data collected in compliance with the MRP and Central Valley Permit. To facilitate data management and transmittal, the RMC participants developed an Information Management System (IMS) to provide SWAMP-compatible storage and import/export of data for all RMC programs, with data formatted in a manner suitable for uploading to CEDEN.

BASMAA subsequently supplemented the IMS to accommodate management of POC data collected by the RMC programs. The expanded IMS provides standardized data storage formats which allow RMC participants to share data among themselves and to submit data electronically to the SFBRWQCB and CVRWQCB.

This page intentionally blank

2 San Francisco Estuary Receiving Water Monitoring (C.8.c)

CCCWP contributes to the Regional Monitoring Program for Water Quality in San Francisco Bay (RMP). Specifically, the Status & Trends Monitoring Program (S&T Program) and the Pilot and Special Studies (P/S Studies) efforts are useful tools for the CCCWP. Brief descriptions of the S&T Program and P/S Studies are provided below.

As described in MRP provision C.8.c, permittees are required to financially contribute their fair-share on an annual basis toward implementing an estuary receiving water monitoring program which, at a minimum, is equivalent to the RMP. As agreed with the CVRWQCB, all CCCWP permittees (in Region 2 and Region 5) comply with this provision by making financial contributions to the San Francisco Bay RMP for purposes of increased efficiencies. Additionally, permittees actively participate in RMP committees and work groups through permittee and/or stormwater program representatives.

The RMP is a long-term monitoring program which is discharger funded and shares direction and participation by regulatory agencies and the regulated community, with the goal of assessing water quality in San Francisco Bay. The regulated community includes permittees, publicly owned treatment works, dredgers, and industrial dischargers. The RMP is intended to answer the following core management questions:

1. Are chemical concentrations in the estuary potentially at levels of concern and are associated impacts likely?
2. What are the concentrations and masses of contaminants in the estuary and its segments?
3. What are the sources, pathways, loadings, and processes leading to contaminant-related impacts in the estuary?
4. Have the concentrations, masses, and associated impacts of contaminants in the estuary increased or decreased?
5. What are the projected concentrations, masses, and associated impacts of contaminants in the estuary?

The RMP budget is generally broken into two major program elements: status and trends monitoring and pilot/special studies. The RMP publishes reports and study results on their website at www.sfei.org/rmp.

2.1 RMP Pilot and Special Studies

The RMP conducts pilot and special studies on an annual basis through committees, workgroups and strategy teams. Studies usually are designed to investigate and develop new monitoring measures related to anthropogenic contamination or contaminant effects on biota in the estuary. Special studies address specific scientific issues that RMP committees and standing workgroups identify as priority for further study. These studies are developed through an open selection process at the workgroup level and are selected for further funding through RMP committees. Results and summaries of the most pertinent pilot and special studies can be found on the RMP web site (<http://www.sfei.org/rmp>).

2.2 RMP Status and Trends Monitoring Program

The Status and Trends Monitoring Program (S&T Program) is the long-term contaminant monitoring component of the RMP. The S&T Program was initiated as a pilot study in 1989 and was redesigned in 2007 based on a more rigorous statistical design aimed to enable the detection of trends. S&T Program is composed of the 5 following program elements:

1. Long-term water, sediment and bivalve monitoring
2. Episodic toxicity monitoring
3. Sport fishing monitoring
4. USGS hydrographic and sediment transport studies
 - a. Factors controlling suspended sediment in San Francisco Bay
 - b. USGS monthly water quality data
5. Triennial bird egg monitoring (cormorant and tern)

Additional information on the S&T Program and associated monitoring data are available for download via the RMP website at <http://www.sfei.org/content/status-trends-monitoring>.

2.3 Participation in Committees, Workgroups and Strategy Teams

CCCWP and/or other BASMAA representatives participate in the following RMP committees and workgroups:

- Steering Committee
- Technical Review Committee
- Sources, Pathways and Loadings Workgroup
- Emergent Contaminant Workgroup
- Nutrient Technical Workgroup
- Strategy teams (e.g., Small Tributaries, PCBs)

Committee and workgroup representation are provided by CCCWP, other storm water program staff and/or individuals designated by RMC participants. Representation includes participation in meetings, review of technical reports and work products, co-authoring or review of articles included in the RMP's *Pulse of the Estuary*, and general program direction to RMP staff. Representatives of the RMP also provide timely summaries and updates to and receive input from BASMAA stormwater program representatives (on behalf of the permittees) during workgroup meetings to ensure the permittees' interests are represented.

3 Creek Status Monitoring (C.8.d)

The MRP and Central Valley Permit require permittees to conduct creek status monitoring intended to assess the chemical, physical, and biological impacts of urban runoff on receiving waters, and answer the following management questions:

1. Are water quality objectives, both numeric and narrative, being met in local receiving waters, including creeks, rivers, and tributaries?
2. Are conditions in local receiving waters supportive of or likely supportive of beneficial uses?

Creek status monitoring parameters, methods, occurrences, duration, and minimum number of sampling sites for each stormwater program are described in provision C.8.d of the MRP and provision C.8.c in the Central Valley Permit. Creek status monitoring coordinated through the RMC began in October 2011 and continues annually. Status and trends monitoring was conducted in non-tidally influenced, flowing water bodies (i.e., creeks, streams, and rivers).

The RMC's regional monitoring strategy for creek status monitoring is described in the Creek Status and Long-Term Trends Monitoring Plan (BASMAA, 2011). The monitoring methods follow the protocols described in the updated BASMAA RMC QAPP (Version 3; BASMAA, 2016a) and SOPs for creek status and pesticides and toxicity monitoring (Version 3; BASMAA, 2016b). The purpose of these SOPs is to provide RMC participants with a common basis for application of consistent monitoring protocols across jurisdictional boundaries. These protocols form part of the RMC's quality assurance program to help ensure validity of resulting data and comparability with SWAMP protocols.

The creek status monitoring parameters required by MRP provisions C.8.d and C.8.g are divided into two types: those conducted under a regional probabilistic design, and those conducted under a local, targeted design. This distinction is shown in Table 2 for the required creek status monitoring parameters. The combination of these monitoring designs allows each individual RMC-participating program to assess the status of beneficial uses in local creeks within its program (jurisdictional) area, while also contributing data to answer management questions at the regional scale (e.g., differences between aquatic life conditions in urban and non-urban creeks).

The RMC monitoring strategy for complying with MRP 2.0 requirements includes continuing a regional ambient/probabilistic monitoring component, and a component based on local/targeted monitoring, as in the previous permit term. The analysis of results from the two creek status monitoring components conducted in WY 2018 is presented in Appendix 1 and Appendix 2, respectively.

Creek status monitoring data for each water year are submitted annually by the CCCWP to the SFBRWQCB and CVRWQCB by March 31 of the following year.

The analysis of results from creek status monitoring conducted in WY 2018 is presented in Appendix 1 (the regional/probabilistic creek status monitoring report for WY 2018) and Appendix 2 (the local/targeted creek status monitoring report for WY 2018).

Table 2. Creek Status Monitoring Parameters Sampled in Compliance with MRP Provisions C.8.d. and C.8.g. as Either Regional/Probabilistic or Local/Targeted Parameters

Biological Response and Stressor Indicators	Monitoring Design	
	Regional/Probabilistic ¹	Local/Targeted ²
Bioassessment, physical habitat assessment, CSCI	X	
Nutrients (and other water chemistry associated with bioassessment)	X	
Chlorine	X	
Water toxicity (wet and dry weather)	X	
Water chemistry (pesticides, wet weather)	X	
Sediment toxicity	X	
Sediment chemistry	X	
General water quality (sonde data: temperature, dissolved oxygen, pH, specific conductance)		X
Temperature, continuous (HOBO data loggers)		X
Bacteria		X

1 For full report, see Appendix 1: Regional/Probabilistic Creek Status Monitoring Report, WY 2018

2 For full report, see Appendix 2: Local/Targeted Creek Status Monitoring Report, WY 2018

CSCI California Stream Condition Index

3.1 Regional/Probabilistic Monitoring

The regional/probabilistic creek status monitoring report (Appendix 1) documents the results of monitoring performed by CCCWP during WY 2018 under the regional/probabilistic monitoring design developed by the RMC. During each water year, 10 sites are monitored by the CCCWP for bioassessment, physical habitat, and related water chemistry parameters. To date, 70 sites have been sampled since the inception of the program.

RMC probabilistic monitoring sites are drawn from a sample frame consisting of a creek network geographic information system (GIS) data set within the RMC boundary⁴ (BASMAA, 2011), including stream segments from all perennial and non-perennial creeks and rivers running through urban and non-urban areas within the portions of the five RMC participating counties within the SFBRWQCB boundary, and the eastern portion of Contra Costa County which drains to the CVRWQCB region. A map of the BASMAA RMC area, equivalent to the area covered by the regional/probabilistic design “sample frame”, is shown in. The sites selected from the regional/probabilistic design master sample draw and monitored in WY 2018 are shown graphically in Figure 1.

The probabilistic design requires several years to produce sufficient data to develop a statistically robust characterization of regional creek conditions. BASMAA has conducted a regional project that has analyzed bioassessment monitoring data collected during a five-year period (2012-2016) by the Programs that would provide recommendations for potential changes to the monitoring program. The project also will develop a fact sheet that presents the report findings in a format accessible to a broad audience.

⁴ Based on discussion during RMC meetings, with SFBRWQCB staff present, the sample frame was extended to include the portion of Eastern Contra Costa County that ultimately drains to San Francisco Bay to address parallel provisions in CCCWP’s Central Valley Region Permit for Eastern Contra Costa County.

The creek status monitoring results are subject to potential follow-up actions, per MRP 2.0 provisions C.8.d. and C.8.g., if they meet certain specified threshold triggers. If monitoring results meet the requirements for follow-up actions, the results are compiled on a list for consideration as potential SSID projects per MRP provision C.8.e. The results are compared to other regulatory standards, including Basin Plan water quality objectives (WQOs), where available and applicable.

3.2 Local/Targeted Monitoring

The local/targeted creek status monitoring report (Appendix 2) documents the results of targeted monitoring performed by CCCWP during WY 2018. Within Contra Costa County, targeted monitoring is conducted annually at:

- Four continuous water temperature monitoring locations
- Two general water quality monitoring locations
- Five pathogen indicator bacteria monitoring locations

Site locations are identified using a targeted monitoring design based on the directed principle to address the following management questions:

- What is the range of general water quality measurements at targeted sites of interest?
- Do general water quality measurements indicate potential impacts to aquatic life?
- What are the pathogen indicator concentrations at creek sites where water contact recreation may occur?

Targeted monitoring data are evaluated against MRP threshold triggers, to assess the potential need for follow-up. The results of WY 2018 monitoring are summarized in Appendix 2.

3.3 Pesticides and Toxicity Monitoring (C.8.g)

Pesticides and toxicity monitoring are separated into their own sub-provision in MRP 2.0 (C.8.g). The pesticides/toxicity monitoring requirements are further separated into:

- C.8.g.i. Toxicity in Water Column – Dry Weather
- C.8.g.ii. Toxicity, Pesticides and Other Pollutants in Sediment – Dry Weather
- C.8.g.iii. Wet Weather Pesticides and Toxicity Monitoring

The RMC QAPP and SOPs were updated in WY 2016 to implement the new requirements of MRP provision C.8.g (BASMAA, 2016a and 2016b). The full reporting of the pesticides and toxicity monitoring is included in Appendix 1, along with the rest of the regional/probabilistic creek status monitoring.

Additionally, in early 2016, the State Water Board began developing “Urban Pesticide Amendments” to the statewide Water Quality Control Plans for the control of pesticide discharges from MS4s, as a project under the statewide Strategy to Optimize Resource Management of Storm Water (Storm Water Strategy; AKA “STORMS”). The STORMS Urban Pesticides Amendments project involves the active participation of CA Department of Pesticide Regulation (DPR) and CASQA, working collaboratively with the Water Boards, and includes three components: 1) MS4 permit requirements, 2) regulatory coordination, and 3) a monitoring program. These three components are expected to provide an appropriate regulatory and scientific framework from which to address the underlying issues of pesticides pollution and associated toxicity in urban receiving waters. The RMC programs help support these efforts by contributing funding

through BASMAA to support CASQA's participation in developing the Amendments and designing the statewide pesticides and toxicity monitoring program.

3.3.1 Toxicity in Water Column – Dry Weather (C.8.g.i)

Water samples are collected annually from one monitoring site during dry weather, in accordance with the dry weather sample index period that initiates on July 1 and continues through September 30. Toxicity testing is run for several different aquatic species, as required by MRP 2.0. Sampling is conducted at a site selected from the probabilistic design for bioassessment monitoring, or at a site targeted to address management questions. Results of dry weather water toxicity testing are presented in Appendix 1.

3.3.2 Toxicity, Pesticides and Other Pollutants in Sediment – Dry Weather (C.8.g.ii)

Once per year during the dry season (July 1 through September 30), sediment samples are collected and tested for toxicity to several different aquatic species, as required by MRP 2.0. Sampling is conducted at a site selected from the probabilistic design for bioassessment monitoring, or at a site targeted to address management questions.

Concurrent with the sediment toxicity sampling described above, sediment chemistry samples are collected for analysis of a select list of pesticides, PAHs, trace elements, total organic carbon (TOC) and grain size. All sediment analytical chemistry (pesticides and other pollutants), grain size analysis and toxicity test results are presented in Appendix 1.

Stressor evaluation results for sites with data collected for sediment chemistry, sediment toxicity, and bioassessment parameters by CCCWP over the first seven years of the RMC regional/probabilistic monitoring effort (water years 2012-2018) are summarized in Appendix 1.

3.3.3 Wet Weather Pesticides and Toxicity Monitoring – Wet Weather (C.8.g.iii)

Once per year during the wet season (October 1 through April 30), water column samples are collected and tested for toxicity to several different aquatic species, as required by MRP 2.0. Sampling is conducted at two sites from the probabilistic design for bioassessment monitoring, or at sites targeted to address management questions.

Concurrent with the water column toxicity sampling described above, water chemistry samples are collected for analysis of a select list of pesticides. Although not required by MRP 2.0, the CCCWP includes sampling and analysis of DOC, TOC and suspended sediment concentration (SSC). All analytical chemistry (pesticides, DOC, TOC, SSC) and toxicity test results are presented in Appendix 1.

4 Stressor/Source Identification Projects (C.8.e)

MRP 2.0 requires stressor/source identification (SSID) projects to be considered when any monitoring result(s) trigger a candidate for a follow-up project. SSID projects are intended to be oriented toward taking action(s) to alleviate stressors and reduce sources of pollutants.

A list of monitoring results exceeding thresholds is maintained by the RMC participants, from which the SSID projects can be selected based on criteria in MRP provision C.8.e.ii. Provision C.8.e.ii.(1) requires permittees who conduct SSID projects through a regional collaborative (such as the BASMAA RMC) to collectively initiate a minimum of eight new SSID projects (minimum of one for toxicity) during the permit term. Most of those projects are conducted by individual programs addressing local needs. RMC programs have agreed that the distribution of the eight required SSID projects will be as follows:

- 2 each: Santa Clara and Alameda counties
- 1 each: San Mateo and Contra Costa counties
- 1 jointly: Fairfield/Suisun and Vallejo
- 1 regionally: All MRP counties

The process for identifying and selecting MRP 2.0 SSID projects through the RMC includes the following elements:

- Review monitoring results annually (C.8.d, C.8.f and C.8.g) annually and update the regional trigger exceedance matrix, which include evaluation of TMDL thresholds (including pyrethroid TUs) to accommodate MRP 2.0 provision C.9. requirements.
- RMC programs jointly consider the threshold trigger results and select follow-up SSID projects from the matrix based on criteria such as magnitude of threshold exceedance; parameter (for a variety of parameters); likelihood stormwater management action(s) could address the exceedance; and similar priorities
- Plan and implement eight SSID projects during the permit term, with the one required project for CCCWP beginning by the third year of the permit term.

The SSID project being conducted by BASMAA as a regional project is focused on electrical utilities as a potential source of PCBs to urban stormwater runoff. The workplan for that SSID project is included in Appendix 3.

A summary of all BASMAA RMC SSID projects proposed or being currently being conducted for MRP 2.0 is also included in Appendix 3.

4.1 Marsh Creek SSID Study – Year 1 Status Report

As detailed above, in accordance to MRP 2.0 provision C.8.e, requires SSID projects to be considered when any monitoring result(s) trigger a candidate for a follow-up project.

Dating back to 2005, there were nine documented fish kills over the past 14 years in Marsh Creek (CCCWP, 2018, and citations therein). These events are often associated with intermittent dry season flows or storm events with varying antecedent dry periods. The most recent event occurred in October 2017. With agreement of the SFBRWQCB and CVRWQCB staff, CCCWP is investigating the potential

causes of fish kills observed in lower Marsh Creek as its MRP 2.0 SSID study. The Marsh Creek SSID Study – Year 1 Status Report is presented in Appendix 4.

5 Pollutants of Concern Monitoring (C.8.f)

Pollutants of concern (POC) load monitoring is intended to assess inputs of POCs to the bay from local tributaries and urban runoff, assess progress toward achieving wasteload allocations (WLAs) for total maximum daily loads (TMDLs), and help resolve uncertainties associated with loading estimates for these pollutants. An updated QAPP and SOP were developed in WY 2016 to implement the POC, toxicity, and pesticide monitoring requirements in MRP 2.0 provisions C.8.f and C.8.g.

Since 2014, CCCWP and permittee staff have conducted source area assessments to delineate high interest parcels and areas for consideration of property referrals and focused implementation planning for PCBs and mercury load reductions. Street dirt drop inlet sediments and stormwater runoff were sampled to locate high interest areas for PCBs source property referral and abatement. Additionally, stormwater monitoring was conducted in targeted locations for copper, nutrients, mercury and methylmercury. A summary report of these data is presented in the CCCWP Pollutants of Concern Monitoring Report: Water Year 2018 Sampling and Analysis (Appendix 5).

MRP 2.0 places an increased focus on finding watersheds, source areas, and source properties that are potentially more polluted and upstream from sensitive bay margin areas (high leverage sites). To support this focus, a stormwater reconnaissance monitoring program was developed and implemented beginning in WY 2015 by the RMP through the STLS workgroup. In WY 2018, four stormwater sampling locations within Contra Costa County were monitored for PCBs and mercury by the RMP. These monitoring results are summarized in the RMP Pollutants of Concern Reconnaissance Monitoring Report: Water Year 2015-2018 report (Appendix 7).

MRP permittees agreed to collectively conduct POC monitoring for management action effectiveness via a BASMAA regional project. The overall goal of monitoring was to evaluate the effectiveness of selected stormwater treatment controls to provide information needed to support RAA development. BASMAA agreed to focus this monitoring effort on two treatment options with the potential to reduce PCBs and mercury discharges: HDS units and enhanced bioretention filters. HDS monitoring focused on collecting sediment removed from HDS unit sumps during maintenance to evaluate the PCBs and mercury load reduction effectiveness. Enhanced bioretention filter monitoring focused on testing various biochars in soil media mixes to identify those which improve PCBs and mercury load removal. The final project reports associated with these studies are attached in Appendix 6.

MRP provision C.12.e. requires permittees to collect samples of caulk and other sealants used in storm drains and between concrete curbs and street pavement, and to investigate whether PCBs are present in such material and in what concentrations. This work was conducted as a BASMAA regional project and contributed to partial fulfillment of POC monitoring required by provision C.8.f of the MRP to address PCBs source identification. The PCBs in Infrastructure Caulk Project report was submitted in the FY 2017-18 Annual Report as Attachment 12.3.

CCCWP credited a due portion of the BASMAA regional project monitoring work in fulfillment of POC requirements under provision C.8.f. as summarized in the Pollutants of Concern Monitoring Report: Water Year 2018 Sampling and Analysis (Appendix 5).

CCCWP began implementation of a methylmercury control study in 2012 to fulfill requirements of the Central Valley Permit (C.11.I). A methylmercury control study work plan was prepared to 1) evaluate the effectiveness of existing best management practices (BMPs) for the control of methylmercury; 2) evaluate additional or enhanced BMPs, as needed, to reduce mercury and methylmercury discharges to the delta; and 3) determine the feasibility of meeting methylmercury waste load allocations. A final report was

submitted in October 2018 which incorporates monitoring efforts conducted since spring 2015 (Amec, 2018).

Finally, MRP provision C.8.f. (Pollutants of Concern Monitoring) Table 8.2 calls for conducting or causing to conduct a study that addresses relevant management information needs for emerging contaminants, at least alternative flame retardants. BASMAA representatives are currently working with the RMP to develop a workplan for a special study to account for relevant contaminants of emerging concern (CECs) in stormwater and would address at least PFOS, PFAS, and alternative flame retardants being used to replace PBDEs.

6 References

- ADH Environmental (ADH) and Applied Marine Sciences (AMS). 2016a. Contra Costa County Clean Water Program Sampling and Analysis Plan DRAFT Pollutants of Concern Monitoring; Pesticides and Toxicity Monitoring. ADH Environmental and Applied Marine Sciences. January 21, 2016.
- ADH Environmental (ADH) and Applied Marine Sciences (AMS). 2016b. Contra Costa County Clean Water Program Quality Assurance Project Plan DRAFT Pollutants of Concern Monitoring; Pesticides and Toxicity Monitoring. ADH Environmental and Applied Marine Sciences. January 26, 2016.
- Amec Environment & Infrastructure (Amec). 2013. Contra Costa Clean Water Program Revised Methylmercury Control Study Work Plan. AMEC Project No. 5025133001. Amec Environment & Infrastructure, Inc. December 2013.
- Amec Environment & Infrastructure (Amec). 2018. Contra Costa Clean Water Program Methylmercury Control Study. AMEC Project No. 5025133001. Amec Environment & Infrastructure, Inc. August 2018.
- Amweg, E.L., Weston, D.P., You, J., Lydy, M.J. 2006. Pyrethroid insecticides and sediment toxicity in urban creeks from California and Tennessee. *Environmental Science & Technology*. 40:1700–1706
- Bay Area Stormwater Management Agencies Association (BASMAA). 2011. Regional Monitoring Coalition Final Creek Status and Long-Term Trends Monitoring Plan. Prepared By EOA, Inc. Oakland, California.
- Bay Area Stormwater Management Agencies Association (BASMAA). 2016a. *Regional Monitoring Coalition Creek Status and Pesticides & Toxicity Monitoring Program Quality Assurance Project Plan*. Prepared By EOA, Inc., Applied Marine Sciences, and Armand Ruby Consulting. Version 3. March.
- Bay Area Stormwater Management Agencies Association (BASMAA). 2016b. *Regional Monitoring Coalition Creek Status and Pesticides & Toxicity Monitoring Standard Operating Procedures*. Prepared By EOA, Inc., Applied Marine Sciences, and Armand Ruby Consulting. Version 3. March.
- Budd, R. 2016. Urban Monitoring in Southern California Watershed, FY15-16 (http://cdpr.ca.gov/docs/emon/pubs/ehapreps/report_270_budd_fy_15_16.pdf)
- California Department of Fish and Wildlife (CDFW). 2016. Memorandum dated October 7, 2016 from Stella McMillin, Senior Environmental Scientist, Wildlife Investigations Laboratory. Re: Fish Kill in Marsh Creek. Lab Number P-3122; Date of loss: July 6, 2016; Necropsy Z16-749; Samples: Fish, crayfish, tadpoles, water; WPCL L-393-16
- Central Valley Regional Water Quality Control Board (CVRWQCB). 2010. California Regional Water Quality Control Board Central Valley Stormwater NPDES Waste Discharge Requirements Order R5-2010-0102. NPDES Permit No. CAS083313. September 23.

- Contra Costa Clean Water Program (CCCWP). 2017. Pollutants of Concern Report: Accomplishments in Water Year 2017 and Allocation of Effort for Water Year 2018. Prepared by ADH Environmental and Amec Foster Wheeler. October 2017.
- Ensminger, M., 2016. Ambient Monitoring in Urban Areas in Northern California, FY15-16 (http://cdpr.ca.gov/docs/emon/pubs/ehapreps/report_299_ensminger.pdf).
- Hladik, M.L., and McWayne, M.M. 2012. Methods of analysis – Determination of pesticides in sediment using gas chromatography/mass spectrometry: U.S. Geological Survey Techniques and Methods 5–C3, 18 p. Available at <http://pubs.usgs.gov/tm/tm5c3>
- Phillips, B.M., Anderson, B.S., Siegler, K., Voorhees, J.P., Tadesse, D., Weber, L., Breuer, R. 2016. Spatial and Temporal Trends in Chemical Contamination and Toxicity Relative to Land Use in California Watersheds: Stream Pollution Trends (SPoT) Monitoring Program. Fourth Report – Seven-Year Trends 2008-2014. California State Water Resources Control Board. Sacramento, California.
- Ruby, A. 2013. Review of Pyrethroid, Fipronil and Toxicity Monitoring Data from California Urban Watersheds. Prepared for the California Stormwater Quality Association (CASQA) by Armand Ruby Consulting.
- San Francisco Bay Regional Water Quality Control Board (SFBRWQCB). 2009. Municipal Regional Stormwater NPDES Permit. Waste Discharge Requirements Order R2-2009-0074. NPDES Permit No. CAS612008. October 14. [MRP 1.0]
- San Francisco Bay Regional Water Quality Control Board (SFBRWQCB). 2011. San Francisco Bay Basin (Region 2) Water Quality Control Plan (Basin Plan). December 31.
- San Francisco Bay Regional Water Quality Control Board (SFBRWQCB). 2015. Municipal Regional Stormwater NPDES Permit. Waste Discharge Requirements Order R2-2015-0049, NPDES Permit No. CAS612008 (MRP 2.0). November 19.
- San Francisco Estuary Institute (SFEI). 2013. Small Tributaries Loading Strategy Multi-Year Plan. <http://www.sfei.org/rmp/stls>
- U.S. Environmental Protection Agency (USEPA). 2000. Water Quality Standards, Establishment of Numeric Criteria for Priority Toxic Pollutants for the State of California. 40 CFR Part 131. Federal Register: Vol. 65, No 97. May 18.

Appendix 1

Regional/Probabilistic Creek Status Monitoring Report: Water Year 2018

This page intentionally blank

Contra Costa Clean Water Program

Regional/Probabilistic Creek Status Monitoring Report: Water Year 2018 (October 2017 – September 2018)

Submitted to



Contra Costa Clean Water Program
255 Glacier Drive
Martinez, California 94553

March 27, 2019

Submitted by



Armand Ruby Consulting
P.O. Box 945
Capitola, California 95010

and



ADH Environmental
3065 Porter Street, Suite 101
Soquel, California 95073

This page intentionally blank

Contra Costa Clean Water Program

Regional/Probabilistic Creek Status Monitoring Report: Water Year 2018 (October 2017 – September 2018)

March 27, 2019

Submitted to

Contra Costa Clean Water Program
255 Glacier Drive
Martinez, California 94553

Submitted by

Armand Ruby Consulting
P.O. Box 945
Capitola, California 95010

and

ADH Environmental
3065 Porter Street, Suite 101
Soquel, California 95073

This page intentionally blank

Table of Contents

List of Acronyms and Abbreviations	v
Acknowledgements	vii
Preface	ix
Executive Summary	xi
1 Introduction	1
2 Study Area and Monitoring Design	5
2.1 Regional Monitoring Coalition Area	5
2.2 Regional Monitoring Design	5
2.2.1 Management Questions	5
2.2.2 Site Selection	8
2.3 Monitoring Design Implementation	8
3 Monitoring Methods	9
3.1 Site Evaluation	9
3.2 Field Sampling and Data Collection Methods	13
3.2.1 Bioassessments	13
3.2.1.1 Benthic Macroinvertebrates (BMI)	13
3.2.1.2 Algae	14
3.2.1.3 Physical Habitat (PHab)	14
3.2.2 Physicochemical Measurements	15
3.2.3 Chlorine	15
3.2.4 Nutrients and Conventional Analytes (Water Chemistry)	15
3.2.5 Water Toxicity	15
3.2.6 Sediment Chemistry and Sediment Toxicity	15
3.3 Laboratory Analysis Methods	16
3.4 Data Analysis	16
3.4.1 Biological Data	18
3.4.1.1 Benthic Macroinvertebrate Data Analysis	18
3.4.1.2 Algae Data Analysis	18
3.4.2 Physical Habitat (PHab) Condition	19
3.4.3 Water and Sediment Chemistry and Toxicity	19
3.5 Quality Assurance/Quality Control (QA/QC)	20
4 Results and Discussion	21
4.1 Statement of Data Quality	21
4.1.1 Bioassessment	21
4.1.2 Sediment Chemistry	22
4.1.3 Water Chemistry	22
4.1.4 Sediment Toxicity	22
4.1.5 Water Toxicity	22
4.2 Biological Condition Assessment	22
4.2.1 Benthic Macroinvertebrate Metrics	23
4.2.2 Algae Metrics	27
4.3 Stressor Assessment	37

4.3.1	Physical Habitat Parameters.....	37
4.3.2	Correlations of Biological and Physical Habitat Parameters	38
4.3.3	Water Chemistry Parameters.....	40
4.3.4	Water Column Toxicity and Chemistry (Wet Weather).....	42
4.3.5	Water Column Toxicity (Dry Weather).....	45
4.3.6	Sediment Toxicity and Sediment Chemistry.....	45
4.3.7	Sediment Triad Analysis	49
4.3.8	Analysis of Condition Indicators and Stressors	50
5	Conclusions and Next Steps	53
5.1	Summary of Stressor Analyses	53
5.2	Next Steps	54
6	References	55

List of Figures

Figure 2.1	Map of BASMAA RMC Area, County Boundaries and Major Creeks	6
Figure 3.1	Results of CCCWP Site Evaluations for WY 2018.....	10
Figure 3.2	Contra Costa County Creek Status Sites Monitored in Water Year 2018.....	12

List of Tables

Table 1.1	Regional Monitoring Coalition (RMC) Participants	2
Table 1.2	Creek Status Monitoring Parameters Sampled in Compliance with MRP Provisions C.8.d and C.8.g as Either Regional/Probabilistic or Local/Targeted Parameters	3
Table 2.1	Cumulative Numbers of Planned Bioassessment Samples Per Monitoring Year.....	7
Table 2.2	Number of Urban and Non-Urban Bioassessment Sites Sampled by CCCWP and SWAMP in Contra Costa County During Water Years 2012-2018	8
Table 3.1	Site Locations, Monitoring Parameters and Dates Sampled at CCCWP Sites from the RMC Probabilistic Monitoring Design in Water Year 2018.....	11
Table 3.2	RMC Standard Operating Procedures Pertaining to Regional Creek Status Monitoring	13
Table 3.3	Requirements for Follow-up for Regional/Probabilistic Creek Status Monitoring Results Per MRP Provisions C.8.d and C.8.g	17
Table 4.1	Designated Beneficial Uses Listed in the San Francisco Bay Region Basin Plan or CCCWP Bioassessment Sites Monitored in Water Year 2018	23
Table 4.2	Benthic Macroinvertebrate Metrics for CCCWP Bioassessment Sites Monitored in Water Year 2018	25
Table 4.3	Results of CSCI Calculations for Water Year 2018 CCCWP Bioassessment Sites	27
Table 4.4	Algal-IBI Scores for the Diatom (D18), Soft Algae (S2) and Hybrid (H20, H21, H23) Indices for Contra Costa Stations Sampled in 2018	28
Table 4.6	Diatom Metric Results for Contra Costa Stations Samples in 2018.....	31
Table 4.7	Soft Algae IBI (S2) and Individual Metric Scores for Contra Costa Stations Samples in 2018.....	32
Table 4.8	Soft Algae Metric Results for Contra Costa Stations Samples in 2018.....	33
Table 4.9	Hybrid (diatom and soft algae) IBI (H20) and Individual Metric Scores for Contra Costa Stations Samples in 2018.....	34

Table 4.10	Hybrid (diatom and soft algae) IBI (H21) and Individual Metric Scores for Contra Costa Stations Sampled in 2018.....	35
Table 4.11	Hybrid (diatom and soft algae) IBI (H23) and Individual Metric Scores for Contra Costa Stations Sampled in 2018.....	36
Table 4.12	Physical Habitat Metrics and Mini-PHab Scores for CCCWP Bioassessment Sites Monitored in Water Year 2018.....	38
Table 4.13	Index of Physical Habitat Integrity (IPI) Scores for CCCWP Bioassessment Sites Monitored in Water Year 2018.....	38
Table 4.14	Summary of PHab and Biological Condition Scores for CCCWP Bioassessment Sites Monitored in Water Year 2018.....	39
Table 4.15	Correlations for PHab and Biological Condition Scores for CCCWP Bioassessment Sites Monitored in Water Year 2018.....	39
Table 4.17	Comparison of Water Quality (Nutrient) Data to Associated Water Quality Thresholds for Water Year 2018 Water Chemistry Results	41
Table 4.18	Summary of Chlorine Testing Results for Samples Collected in Water Year 2018 in Comparison to Municipal Regional Permit Trigger Criteria	42
Table 4.19	Summary of CCCWP Water Year 2018 Wet Season Water Toxicity Results	43
Table 4.20	CCCWP Water Year 2018 Wet Season Water Chemistry Results: Detected Pesticides and Calculated Toxic Unit Equivalents and Concentration Goal Units	43
Table 4.21	Summary of CCCWP Water Year 2018 Dry Season Water Toxicity Results	45
Table 4.22	Summary of CCCWP Water Year 2018 Dry Season Sediment Toxicity Results.....	46
Table 4.23	CCCWP Water Year 2018 Sediment Chemistry Results	46
Table 4.24	Threshold Effect Concentration (TEC) and Probable Effect Concentration (PEC) Quotients for Water Year 2018 Sediment Chemistry Constituents	48
Table 4.25	Calculated Pyrethroid Toxic Unit Equivalents, Water Year 2018 Sediment Chemistry Data..	49
Table 4.26	Summary of Sediment Quality Triad Evaluation Results, Water Years 2012-2018 Data	50

This page intentionally blank

List of Acronyms and Abbreviations

ACCWP	Alameda Countywide Clean Water Program
AFDM	ash-free dry mass
A-IBI	algal index of biological integrity
Basin Plan	common term for the Regional Water Quality Control plan
BASMAA	Bay Area Stormwater Management Agencies Association
B-IBI	benthic index of biological integrity
BMI	benthic macroinvertebrate
CCCWP	Contra Costa Clean Water Program
CCMAP	Contra Costa Monitoring and Assessment Program
Central Valley Permit	East Contra Costa County Municipal NPDES Permit
CGU	concentration goal units
cm	centimeter
CSCI	California Stream Condition Index
CVRWQCB	Central Valley Regional Water Quality Control Board
DO	dissolved oxygen
DOC	dissolved organic carbon
DQO	data quality objective
FSURMP	Fairfield-Suisun Urban Runoff Management Program
GIS	geographic information system
GRTS	Generalized Random Tessellated Stratified
IBI	Index of Biological Integrity
LC ₅₀	lethal concentration to 50 percent of test organisms
m	meters
MCL	maximum contaminant level
MDL	method detection limit
MPC	Monitoring and Pollutants of Concern Committee
MRP	Municipal Regional Permit
MUN	municipal and domestic water supply
ND	not detected
NPDES	National Pollutant Discharge Elimination System
NT	non-target
PAH	polycyclic aromatic hydrocarbon
PEC	probable effect concentration
PHab	physical habitat assessment
QA/QC	quality assurance/quality control
QAPP	quality assurance project plan
PSA	perennial streams assessment
RL	reporting limit
RMC	Regional Monitoring Coalition
RPD	relative percent difference
RWB	reach-wide benthos
RWQCB	regional water quality control board
SCVURPPP	Santa Clara Valley Urban Runoff Pollution Prevention Program
SFBRWQCB	San Francisco Bay Regional Water Quality Control Board
SMC	Southern California Stormwater Monitoring Coalition
SMCWPPP	San Mateo Countywide Water Pollution Prevention Program
SOP	standard operating procedure

SSID	stress/source identification
STE	standard taxonomic effort
SWAMP	Surface Water Ambient Monitoring Program
TEC	threshold effect concentration
TMDL	total maximum daily load
TNS	target not sampled (or sampleable)
TOC	total organic carbon
TS	target sampled
TU	toxic unit
U	unknown
UCMR	Urban Creeks Monitoring Report
USEPA	U.S. Environmental Protection Agency
WQO	water quality objective
WY	water year

Acknowledgements

This report was prepared by Armand Ruby Consulting in association with ADH Environmental, under contract to and supervision of the Contra Costa Clean Water Program. The report format and organization are in part derived from the original, region-wide Regional Monitoring Coalition (RMC) monitoring report for water year 2012 (Regional Urban Creeks Status Monitoring Report, Appendix A to the Water Year 2012 Urban Creeks Monitoring Report), prepared by EOA, Inc. and Armand Ruby Consulting jointly as a regional project for the RMC participants.

In addition to the RMC participants, San Francisco Bay Regional Water Quality Control Board staff members Kevin Lunde and Jan O'Hara participated in the RMC work group meetings, which contributed to the design and implementation of the RMC Monitoring Plan. These staff members also provided input on the outline of the initial regional urban creek status monitoring report and threshold trigger analyses conducted herein.

CCCWP staff, specifically Lucile Paquette, provided project supervision and review of draft documents. Alessandro Hnatt served as project manager for ADH Environmental, lead consultant to CCCWP. The staff of ADH Environmental also contributed to both the content and production of this report, with respect to data compilation and extraction, organization of metadata, and graphics production. Marco Sigala of Coastal Conservation and Research in Moss Landing provided algae data analysis and interpretation, and assistance with preparation of watershed GIS information and other metrics used in computation of CSCI scores and IPI scores.

This page intentionally blank

Preface

The Regional Monitoring Coalition of the Bay Area Stormwater Management Agencies Association developed a probabilistic design for regional characterization of selected creek status monitoring parameters. The following program participants make up the Regional Monitoring Coalition:

- Alameda Countywide Clean Water Program
- Contra Costa Clean Water Program
- San Mateo Countywide Water Pollution Prevention Program
- Santa Clara Valley Urban Runoff Pollution Prevention Program
- Fairfield-Suisun Urban Runoff Management Program
- City of Vallejo and Vallejo Sanitation and Flood Control District

This report fulfills reporting requirements for the portion of the regional/probabilistic creek status monitoring data generated within Contra Costa County during water year 2018 (October 1, 2017-September 30, 2018) through the Regional Monitoring Coalition's probabilistic design for certain parameters monitored per Municipal Regional Stormwater Permit provisions C.8.d and C.8.g. This report is an appendix to the Contra Costa Clean Water Program's urban creeks monitoring report for water year 2018 and complements similar reports submitted by each of the other participating Regional Monitoring Coalition programs on behalf of their respective permittees.

This page intentionally blank

Executive Summary

This report documents the results of monitoring performed by Contra Costa Clean Water Program (CCCWP) during water year 2018 (October 1, 2017-September 30, 2018) under the regional/probabilistic monitoring design developed by the Regional Monitoring Coalition (RMC). This report is a component of the Urban Creeks Monitoring Report (UCMR) for water year 2018. Together with the creek status monitoring data reported in the local/targeted creek status monitoring report for water year 2018 (ADH, 2019), this submittal fulfills reporting requirements for creek status monitoring specified in provisions C.8.d and C.8.g of the Municipal Regional Permit (MRP) for urban stormwater issued by the San Francisco Bay Regional Water Quality Control Board (Order No. R2-2015-0049) and the East Contra Costa County Municipal NPDES Permit issued by the Central Valley Regional Water Quality Control Board (Order No. R5-2010-0102).

Other creek status monitoring parameters were addressed using a targeted design, with regional coordination and common methodologies. The local/targeted parameters are reported in Appendix 2 of CCCWP's UCMR for water year 2018 (ADH, 2019).

During water year 2018, 10 sites were monitored by CCCWP under the regional/probabilistic design for bioassessment, physical habitat, and related water chemistry parameters. Two sites also were monitored for wet weather (stormwater) toxicity and pesticides chemistry. One other site was monitored for dry season water and sediment toxicity and sediment chemistry.

The bioassessment and related data are used to develop a preliminary conditional assessment for the monitored sites, to be used in conjunction with the stressor assessment based on sediment chemistry and toxicity. The water and sediment chemistry and toxicity data are used to evaluate potential stressors which may affect aquatic habitat quality and beneficial uses.

The probabilistic design requires several years to produce sufficient data to develop a statistically robust characterization of regional creek conditions. BASMAA has conducted a regional project that has analyzed bioassessment monitoring data collected during a five-year period (2012-2016) by the programs that will be used to provide recommendations for potential changes to the monitoring program. The project also will develop a fact sheet that presents the report findings in a format accessible to a broad audience.

California Stream Condition Index (CSCI) scores were calculated from the CCCWP bioassessment data compiled during spring 2018. The CSCI uses location-specific geographic information system (GIS) data to compare the observed benthic macroinvertebrate (BMI) taxonomic data to expected BMI assemblage characteristics from reference sites with similar geographical characteristics. By definition, the reference sites are located in streams that are relatively unimpaired.

All calculated CSCI scores for the water year 2018 samples were below the MRP 2.0 threshold of 0.795, indicating degraded benthic biological communities at the 10 sites monitored by CCCWP in water year 2018. Additional work will need to be completed with the CSCI scores in relation to this threshold to make a clearer assessment of relative biological conditions for these urban streams.

The principal potential stressors identified in the chemical analyses continue to be pesticides. Based on an analysis of the regional/probabilistic data collected by CCCWP during water year 2018, the stressor analysis is summarized as follows:

Physical Habitat (PHab) Conditions

PHab metrics, including the recently developed Index of Physical Habitat Integrity (IPI), were significantly correlated with both the CSCI and Contra Costa B-IBI biological condition indicators for water year 2018 data. This lends potential support to the concept that physical habitat characteristics may impact benthic biological community quality.

Water Quality

Of the 12 water quality parameters required in association with bioassessment monitoring, applicable water quality standards were only identified for ammonia, chloride, and nitrate + nitrite (for sites with MUN beneficial use only). Four of the results generated at the 10 sites monitored by CCCWP during water year 2018 exceeded the applicable water quality standard for un-ionized ammonia; these results are anomalous. While laboratory error is suspected, a follow-up investigation did not reveal any direct evidence of laboratory quality control issues.

Water Toxicity

The West Branch Alamo Creek (site 204R01412) and Marsh Creek (site 544R04613) stormwater samples from January 8 were toxic to *Hyalella azteca*. The Marsh Creek sample *Hyalella azteca* result was less than 50 percent of the lab control, and therefore required retesting. The March 1 retest sample from the Marsh Creek site also was highly toxic to *Hyalella azteca*. Pesticide concentrations were determined in all cases to be more than sufficient to have caused the observed toxicity.

Sediment Toxicity

The Marsh Creek sediment sample was determined to be toxic to *Hyalella azteca*, but not to *Chironomus dilutus*. The pyrethroid pesticide bifenthrin was determined to be a probable cause of the observed sediment toxicity. The dry weather water sample at Marsh Creek was not toxic.

Sediment Chemistry

The pyrethroid pesticide bifenthrin was detected at quantifiable levels in the creek sediment sample, but the sum of pyrethroid pesticides did not exceed one toxic unit equivalent (1 TU). Another common current-use pesticide, fipronil, was not detected, but all three of the fipronil degradates were detected in the sediment sample.

Sediment Triad Analyses

Bioassessment, sediment toxicity, and sediment chemistry results were evaluated as the three lines of evidence used in the triad approach for assessing overall stream condition and added to the compiled results for water years 2012-2018. Good correlation is observed throughout that period in the triad analysis between pyrethroid concentrations with TU ≥ 1 and sediment toxicity.

The chemical stressors, particularly pesticides, may be contributing to the degraded biological conditions indicated by the low CSCI and B-IBI scores in many of the monitored streams.

Efforts are currently underway by the RMC to implement a set of stressor/source identification (SSID) projects for implementation during the current MRP term. CCCWP will continue to collaborate in this regional effort. Per MRP 2.0, eight SSID projects are required regionally if performed within a regional collaborative. CCCWP is performing one new SSID project during the MRP 2.0 permit term, and is participating in one regionally-coordinated project, per agreement within the RMC. The current list of SSID projects is included as Appendix 3 to CCCWP's urban creeks monitoring report for water year 2018.

As required by MRP 2.0 provision C.8.g.iii, the Regional Monitoring Coalition completed wet season toxicity and chemistry monitoring in water year 2018.

Candidate probabilistic sites previously classified with "unknown" sampling status in the Regional Monitoring Coalition probabilistic site evaluation process may continue to be evaluated for potential sampling in water year 2019.

This page intentionally blank

1 Introduction

Contra Costa County lies within the jurisdictions of both the San Francisco Bay Regional Water Quality Control Board (SFBRWQCB; Region 2) and the Central Valley Regional Water Quality Control Board (CVRWQCB; Region 5). Municipal stormwater discharges in Contra Costa County were regulated by the requirements of two National Pollutant Discharge Elimination System (NPDES) stormwater permits: Municipal Regional Permit (MRP) in Region 2 (Order No. R2-2015-0049¹), and the East Contra Costa County Municipal NPDES Permit (Central Valley Permit) in Region 5 (Order No. R5-2010-0102²).

Prior to the reissuance of the second version of the MRP in 2015, the requirements of the two permits were effectively identical. With the reissued MRP, there were some differences between the permits, although in most respects the creek status monitoring and reporting requirements remain similar.

This report is a component of the Urban Creeks Monitoring Report (UCMR) for water year (WY) 2018, covering creek status monitoring conducted under a regional/probabilistic design. Together with the creek status monitoring data reported in *Local/Targeted Creek Status Monitoring Report: Water Year 2018* (ADH, 2019), this submittal fulfills reporting requirements for creek status monitoring performed per the requirements of provisions C.8.d and C.8.g of the MRP, as well as complementary requirements in the Central Valley permit.

The regional/probabilistic design was developed and implemented by the Regional Monitoring Coalition (RMC) of the Bay Area Stormwater Management Agencies Association (BASMAA). This monitoring design allows each RMC participating program to assess stream ecosystem conditions within its program area (e.g., county boundary), while contributing data to answer regional management questions about water quality and beneficial use conditions in the creeks of the San Francisco Bay Area.

CCCWP conducted extensive bioassessment monitoring prior to the adoption of the original MRP (SFBRWQCB, 2009). Summaries of those findings can be found in *Preliminary Assessment of Aquatic Life Use Condition in Contra Costa Creeks, Summary of Benthic Macroinvertebrate Bioassessment Results (2001-2006)* (CCCWP, 2007), and *Contra Costa Monitoring and Assessment Program, Summary of Benthic Macroinvertebrate Bioassessment Results (2011)* (Ruby, 2012).

The RMC was formed in early 2010 as a collaboration among several BASMAA members representing MRP permittees (Table 1.1), to implement the creek status monitoring requirements of the MRP through a regionally-coordinated effort.

The RMC Work Group is a subgroup of the BASMAA Monitoring and Pollutants of Concern Committee (MPC) which meets and communicates regularly to coordinate planning and implementation of monitoring-related activities. The RMC Work Group meetings are coordinated by an RMC coordinator and funded by the RMC's participating county stormwater programs. This work group includes staff from the SFBRWQCB at two levels: those generally engaged with the MRP, as well as those working regionally

¹ The San Francisco Bay Regional Water Quality Control Board adopted the reissued Municipal Regional Stormwater NPDES Permit (Order No. R2-2015-0049) to 76 cities, counties and flood control districts (i.e., permittees) in the Bay Area on November 19, 2015 (SFBRWQCB, 2015), effective January 1, 2016. The BASMAA programs supporting MRP regional projects include all MRP permittees, plus the eastern Contra Costa County cities of Antioch, Brentwood, and Oakley, which have voluntarily elected to participate in the RMC. The RMC regional monitoring design was expanded to include the eastern portion of Contra Costa County which is within the Central Valley Region (Region 5) to assist CCCWP in fulfilling parallel provisions in the Central Valley Permit.

² The Central Valley Regional Water Quality Control Board issued the East Contra Costa County Municipal NPDES Permit (Order No. R5-2010-0102) on September 23, 2010 (CVRWQCB, 2010). Superseded by Order R2-2019-0004, incorporating the eastern portion of Contra Costa County within the requirements of the MRP, Order R2-2015-0049.

with the State of California's Surface Water Ambient Monitoring Program (SWAMP). Through the RMC Work Group, the BASMAA RMC developed a quality assurance project plan (QAPP; BASMAA, 2016a), standard operating procedures (SOPs; BASMAA, 2016b), data management tools, and reporting templates and guidelines. Costs for these activities are shared among RMC members.

Table 1.1 Regional Monitoring Coalition (RMC) Participants

Stormwater Programs	RMC Participants
Santa Clara Valley Urban Runoff Pollution Prevention Program (SCVURPPP)	Cities of Campbell, Cupertino, Los Altos, Milpitas, Monte Sereno, Mountain View, Palo Alto, San Jose, Santa Clara, Saratoga, Sunnyvale, Los Altos Hills, and Los Gatos; Santa Clara Valley Water District; and Santa Clara County
Alameda Countywide Clean Water Program (ACCWP)	Cities of Alameda, Albany, Berkeley, Dublin, Emeryville, Fremont, Hayward, Livermore, Newark, Oakland, Piedmont, Pleasanton, San Leandro, and Union City; Alameda County; Alameda County Flood Control and Water Conservation District; and Zone 7 Water Agency
Contra Costa Clean Water Program (CCCWP)	Cities/Towns of Antioch, Brentwood, Clayton, Concord, El Cerrito, Hercules, Lafayette, Martinez, Oakley, Orinda, Pinole, Pittsburg, Pleasant Hill, Richmond, San Pablo, San Ramon, Walnut Creek, Danville, and Moraga; Contra Costa County; and Contra Costa County Flood Control and Water Conservation District
San Mateo Countywide Water Pollution Prevention Program (SMCWPPP)	Cities and towns of Belmont, Brisbane, Burlingame, Daly City, East Palo Alto, Foster City, Half Moon Bay, Menlo Park, Millbrae, Pacifica, Redwood City, San Bruno, San Carlos, San Mateo, South San Francisco, Atherton, Colma, Hillsborough, Portola Valley, and Woodside; San Mateo County Flood Control District; and San Mateo County
Fairfield-Suisun Urban Runoff Management Program (FSURMP)	Cities of Fairfield and Suisun City
Vallejo Permittees	City of Vallejo and Vallejo Sanitation and Flood Control District

The goals of the RMC are to:

- Assist RMC permittees in complying with requirements in MRP provision C.8 (water quality monitoring)
- Develop and implement regionally consistent creek monitoring approaches and designs in the San Francisco Bay Area through improved coordination among RMC participants and other agencies sharing common goals (e.g., regional water quality control boards, Regions 2 and 5, and SWAMP)
- Stabilize the costs of creek monitoring by reducing duplication of effort and streamlining monitoring and reporting

The RMC divided the creek status monitoring requirements required by MRP provisions C.8.d and C.8.g into those parameters which could reasonably be included within a regional/probabilistic design, and those which, for logistical and jurisdictional reasons, should be implemented locally using a targeted (non-probabilistic) design. The monitoring elements included in each category are specified in Table 1.2. Creek status monitoring data collected by CCCWP at local/targeted sites (and not included in the regional/probabilistic design) are reported separately in Appendix 2 of the CCCWP WY 2018 UCMR (ADH, 2019).

The remainder of this report addresses study area and monitoring design (Section 2), data collection and analysis methods (Section 3), results and data interpretation (Section 4), and conclusions and next steps

(Section 5). Additional information on other aspects of permit-required monitoring is found elsewhere in the CCCWP WY 2018 UCMR and its appendices.

Table 1.2 Creek Status Monitoring Parameters Sampled in Compliance with MRP Provisions C.8.d and C.8.g as Either Regional/Probabilistic or Local/Targeted Parameters

Biological Response and Stressor Indicators	Monitoring Design	
	Regional Ambient (Probabilistic)	Local (Targeted)
Bioassessment, physical habitat assessment, CSCI	X	
Nutrients (and other water chemistry associated with bioassessment)	X	
Chlorine		X
Water toxicity (wet and dry weather)	NA	
Water chemistry (pesticides, wet weather) ¹	NA	
Sediment toxicity (dry weather)	NA	
Sediment chemistry (dry weather)	NA	
General water quality (sonde data: temperature, dissolved oxygen, pH, specific conductivity)		X
Temperature (HOBO data loggers)		X
Bacteria		X

¹ Per RMC decision, with Water Board staff concurrence and in accordance with MRP provision C.8.g.iii.(3), this monitoring commenced in WY 2018

NA Monitoring design not applicable to monitoring parameter

This page intentionally blank

2 Study Area and Monitoring Design

2.1 Regional Monitoring Coalition Area

For the purposes of the regional/probabilistic monitoring design, the study area is equal to the RMC area, encompassing the political boundaries of the five RMC participating counties, including the eastern portion of Contra Costa County which drains to the Central Valley region. A map of the BASMAA RMC area, equivalent to the area covered by the regional/probabilistic design sample frame, is shown in Figure 2.1.

2.2 Regional Monitoring Design

In 2011, the RMC developed a regional/probabilistic monitoring design to identify ambient conditions of creeks in the five main counties subject to the requirements of the MRP. The regional design was developed using the Generalized Random Tessellation Stratified (GRTS) approach developed by the U.S. Environmental Protection Agency (USEPA) and Oregon State University (Stevens and Olson, 2004). The GRTS approach has been implemented in California by several agencies, including the statewide perennial streams assessment (PSA) conducted by SWAMP (Ode et al., 2011) and the Southern California Stormwater Monitoring Coalition's (SMC's) regional monitoring (Southern California Stormwater Monitoring Coalition, 2007). The RMC area is considered to define the sample frame and represent the sample universe from which the regional "sample draw" (the randomized list of potential monitoring sites) is produced.

2.2.1 Management Questions

The RMC regional monitoring probabilistic design was developed to address the following management questions:

- What is the condition of aquatic life in creeks in the RMC area? Are water quality objectives met and are beneficial uses supported?
- What is the condition of aquatic life in the urbanized portion of the RMC area? Are water quality objectives met and are beneficial uses supported?
- What is the condition of aquatic life in RMC participant counties? Are water quality objectives met and are beneficial uses supported?
- To what extent does the condition of aquatic life in urban and non-urban creeks differ in the RMC area?
- To what extent does the condition of aquatic life in urban and non-urban creeks differ in each of the RMC participating counties?
- What are major stressors to aquatic life in the RMC area?
- What are major stressors to aquatic life in the urbanized portion of the RMC area?
- What are the long-term trends in water quality in creeks over time?

Figure 2.1 Map of BASMAA RMC Area, County Boundaries and Major Creeks

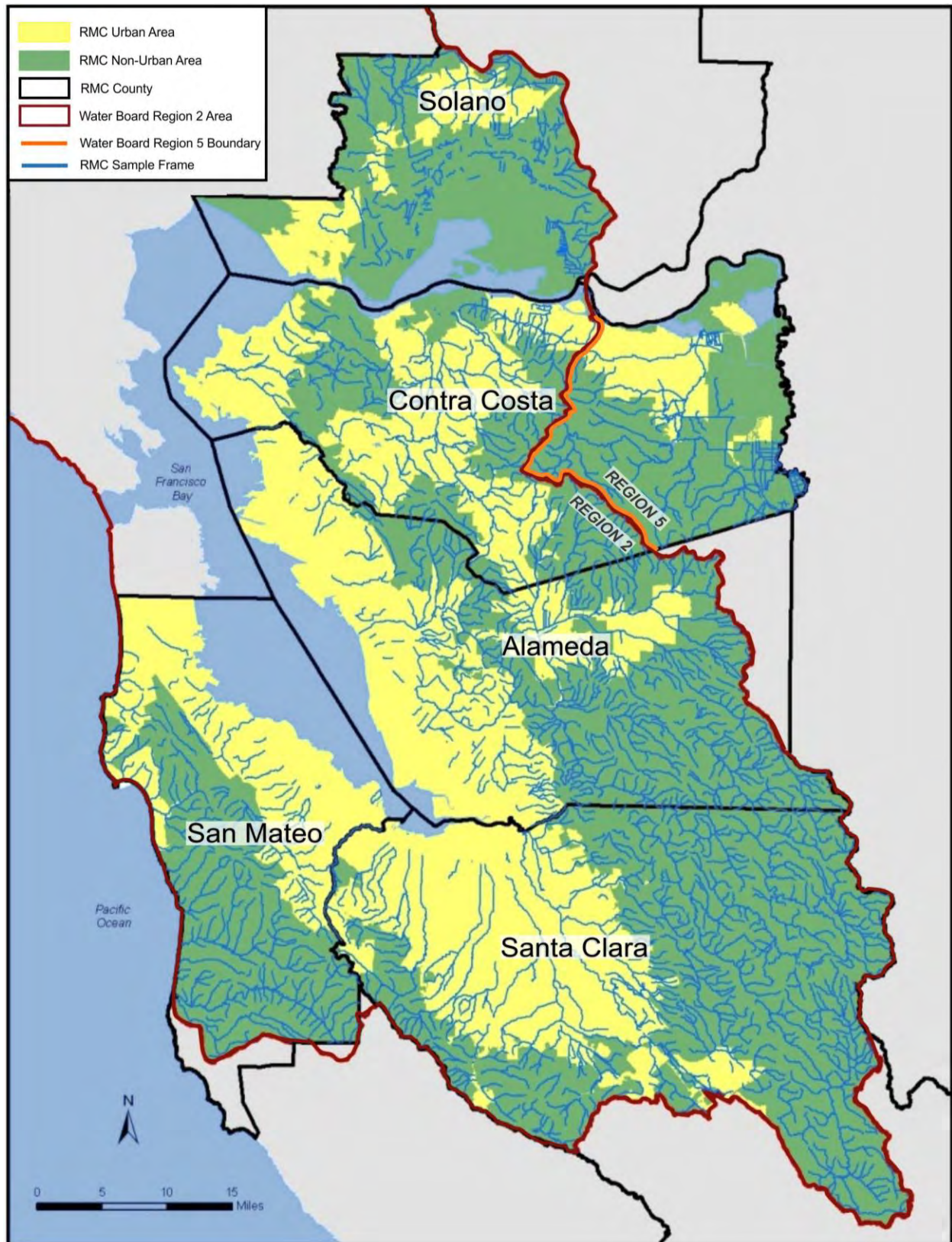

The regional design includes bioassessment monitoring to address the first set of questions regarding aquatic life condition. Assemblages of freshwater organisms are commonly used to assess the biological integrity of water bodies because they provide direct measures of ecological condition (Karr and Chu, 1999).

Benthic macroinvertebrates (BMIs) are an essential link in the aquatic food web, providing food for fish and consuming algae and aquatic vegetation (Karr and Chu, 1999). The presence and distribution of BMIs can vary across geographic locations based on elevation, creek gradient, and substrate (Barbour et al., 1999). These organisms are sensitive to disturbances in water and sediment chemistry, as well as to physical habitat, both in the stream channel and along the riparian zone. Due to their relatively long life cycles (approximately one year) and limited migration, BMIs are particularly susceptible to site-specific stressors (Barbour et al., 1999). Algae also are increasingly used as indicators of water quality, as they form the autotrophic base of aquatic food webs and exhibit relatively short life cycles which respond quickly to chemical and physical changes. Diatoms are found to be particularly useful for interpreting some causes of environmental degradation (Hill et al., 2000); therefore, both BMI and algae taxonomic data are used in the aquatic life assessments.

Additional water quality parameters, including water and sediment toxicity testing and chemical analysis, along with physical habitat characteristics, are then used to assess potential stressors to aquatic life.

Table 2.1 shows conservative estimates of the expected cumulative progress toward establishing statistically representative sample sizes (estimated to be achieved at approximately $n \geq 30$) for each of the classified strata in the regional monitoring design, based on early planning efforts. As of WY 2016, four of the five RMC participating counties achieved the cumulative sample numbers required for such statistical analysis.

Table 2.1 Cumulative Numbers of Planned Bioassessment Samples Per Monitoring Year

Monitoring Year	Totals for RMC Area (Region-wide)		Santa Clara County		Alameda County		Contra Costa County		San Mateo County		Fairfield, Suisun City and Vallejo	
	Urban	Non-Urban	Urban	Non-Urban	Urban	Non-Urban	Urban	Non-Urban	Urban	Non-Urban	Urban	Non-Urban
Year 1 (WY 2012)	48	22	16	6	16	6	8	4	8	4	0	2
Year 2 (WY 2013)	100	44	32	12	32	12	16	8	16	8	8	0
Year 3 (WY 2014)	156	66	48	18	48	18	24	12	24	12	12	6
Year 4 (WY 2015)	204	88	64	24	64	24	32	16	32	16	12	8
Year 5 (WY 2016)	256	110	80	30	80	30	40	20	40	20	16	10

Notes:

Shaded cells indicate when a minimum sample size (estimated to be $n \geq 30$) may be available to develop a statistically representative data set to address management questions related to condition of aquatic life for the strata included within the regional/probabilistic design.

Non-urban site tallies assume countywide programs will attempt to monitor an average of two non-urban sites annually in each RMC county in MRP 2.0.

2.2.2 Site Selection

Status and trends monitoring was conducted in non-tidally influenced, flowing water bodies (i.e., creeks, streams and rivers). The water bodies monitored were drawn from a master list which included all perennial and non-perennial creeks and rivers running through urban and non-urban areas within the RMC area. Sample sites were selected and attributed using the GRTS approach from a sample frame consisting of a creek network geographic information system (GIS) data set within the RMC boundary (BASMAA, 2011), within five management units corresponding to the five participating RMC counties. The National Hydrography Dataset Plus (1:100,000) was selected as the creek network data layer to provide consistency with both the statewide PSA and the SMC, and the opportunity for future data coordination with these programs.

The RMC sample frame was stratified by county and land use (i.e., urban and non-urban) to allow for comparisons within those strata. Urban areas were delineated by combining urban area boundaries and city boundaries defined by the U.S. Census Bureau of 2000. Non-urban areas were defined as the remainder of the areas within the sample universe (RMC area).

Based on discussion during RMC meetings, with SFBRWQCB staff present, RMC participants weight their sampling to ensure at least 80 percent of monitored sites are in urban areas and not more than 20 percent in non-urban areas. RMC participants coordinated with SWAMP and Regional Water Quality Control Board staff by identifying additional non-urban sites from their respective counties for SWAMP monitoring. For Contra Costa County, SWAMP monitoring included non-urban bioassessment sites chosen from the probabilistic sample draw in the Region 2 (San Francisco Bay) area of Contra Costa County, with the regional focus varying annually.

2.3 Monitoring Design Implementation

The number of probabilistic sites monitored annually in water years 2012 through 2018 by CCCWP are shown by land use category in Table 2.2. This tally includes non-urban sites monitored by SWAMP personnel.

Table 2.2 Number of Urban and Non-Urban Bioassessment Sites Sampled by CCCWP and SWAMP in Contra Costa County During Water Years 2012-2018

Monitoring Year	Contra Costa County	
	Land Use	
	Urban Sites	Non-Urban Sites ^a
WY 2012	8	2/2
WY 2013	10	0/3
WY 2014	10	0/1
WY 2015	10	0/1
WY 2016	10	0/0
WY 2017	10	0/0
WY 2018	9	1/0
Total	68	9

a Non-urban sites are shown as sampled by CCCWP/SWAMP for each year. The total represents combined non-urban sites.

3 Monitoring Methods

3.1 Site Evaluation

Sites identified in the regional sample draw were evaluated by each RMC participant in numerical order using the process defined in the RMC SOPs (BASMAA, 2016b). Each site was evaluated to determine if it met the following RMC sampling location criteria:

1. The location (latitude/longitude) provided for a site is located on or is within 300 meters (m) of a non-impounded receiving water body
2. The site is not tidally influenced
3. The site is wadable during the sampling index period
4. The site has sufficient flow during the sampling index period to support SOPs for biological and nutrient sampling
5. The site is physically accessible and can be entered safely at the time of sampling
6. The site may be physically accessed and sampled within a single day
7. Landowner(s) grants permission to access the site³

In the first step, these criteria were evaluated to the extent possible using desktop analysis.

For sites which successfully passed the initial desktop analysis, site evaluations were completed during the second step via field reconnaissance visits. Based on the outcome of the site evaluations, sites were classified into one of four categories:

Target Sampleable (TS): sites meeting all seven criteria were classified as target sampleable (TS)

Target Non-Sampleable (TNS): sites meeting criteria 1 through 4, but not meeting at least one of criteria 5 through 7, were classified as target non-sampleable (TNS)

Non-Target (NT): sites not meeting at least one of criteria 1 through 4 were classified as non-target status and were not sampled

Unknown (U): sites were classified with unknown status and not sampled when it could be reasonably inferred, either via desktop analysis or a field visit, the site was a valid receiving water body and information for any of the seven criteria was unconfirmed

The outcomes of these site evaluations for CCCWP sites for WY 2018 are illustrated in Figure 3.1. A relatively small fraction of sites evaluated each year are classified as target sampleable sites.

³ If landowners did not respond to at least two attempts to contact them, either by written letter, e-mail or phone call, permission to access the respective site was effectively considered to be denied.

Figure 3.1 Results of CCCWP Site Evaluations for WY 2018

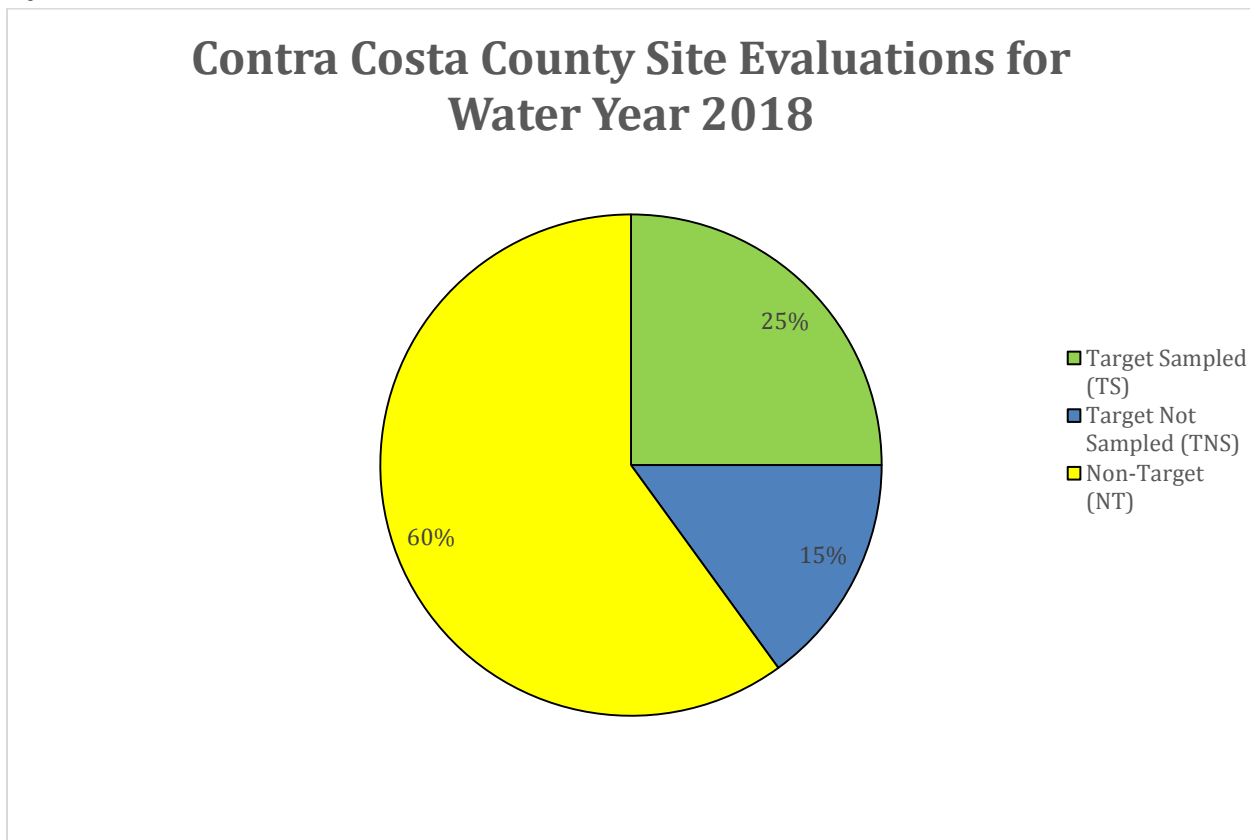

During the site evaluation field visits, flow status was recorded as one of five categories:

Wet Flowing: continuously wet or nearly so; flowing water

Wet Trickle: continuously wet or nearly so; very low flow; trickle less than 0.1 L/second

Majority Wet: discontinuously wet; greater than 25 percent by length of stream bed covered with water; isolated pools

Minority Wet: discontinuously wet; less than 25 percent of stream bed by length covered with water; isolated pools

No Water: no surface water present

Observations of flow status during pre-wet-weather, fall site reconnaissance events and during post-wet-weather, spring sampling were combined to classify sites as perennial or nonperennial as follows:

Perennial: fall flow status is either Wet Flowing or Wet Trickle, and spring flow is sufficient to sample

Non-Perennial: fall flow status is Majority Wet, Minority Wet, or No Water, and spring flow is sufficient to sample

The probabilistic sites selected for monitoring in WY 2018, following site evaluation, are shown graphically in Figure 3.2 as the bioassessment sites, and are listed with additional site information in Table 3.1. As shown in Table 3.1, one of the bioassessment sites (Marsh Creek, site 544R01737) was the site selected for dry weather water toxicity, sediment toxicity and sediment chemistry testing, while two additional sites (one on West Branch Alamo Creek, one on Marsh Creek) were selected for wet weather (stormwater) chemistry and toxicity testing.

Table 3.1 Site Locations, Monitoring Parameters and Dates Sampled at CCCWP Sites from the RMC Probabilistic Monitoring Design in Water Year 2018

Site ID	Creek Name	Land Use	Latitude	Longitude	Bioassessment, PHab, Chlorine, Nutrients	Stormwater Toxicity and Chemistry (Wet Weather)	Water Toxicity and Sediment Toxicity and Chemistry (Dry Weather)
204R02068	South San Ramon Creek	Urban	37.74792	-121.94346	05/31/18		
206R01495	Pinole Creek	Urban	37.97919	-122.26354	05/29/18		
206R02203	Lauterwasser Creek	Urban	37.8955	-122.1926	05/30/18		
206R02343	Wildcat Creek	Urban	37.96171	-122.35447	05/15/18		
207R01600	Mt. Diablo Creek	Urban	38.01669	-122.02438	05/14/18		
207R01899	Mitchell Creek	Urban	37.94118	-121.93701	05/14/18		
207R02315	Grayson Creek	Urban	37.97958	-122.0686	05/30/18		
207R04027	Pine Creek	Non-urban	37.89318	-121.99378	05/17/18		
544R01737	Marsh Creek	Urban	37.96267	-121.68748	05/16/18		07/17/18
544R01993	Marsh Creek	Urban	37.93229	-121.71109	05/16/18		
204R01412	West Branch Alamo Creek	Urban	37.78499	-121.92294		01/08/18	
544R04613	Marsh Creek	Urban	37.99031	-121.69585		01/08/18	
544R04613	Marsh Creek	Urban	37.99031	-121.69585		03/01/18*	

* Re-test following finding of significant toxicity in the 01/08/18 Marsh Creek sample.

Figure 3.2 Contra Costa County Creek Status Sites Monitored in Water Year 2018



Note: Bioassessment sites are those selected from the RMC Probabilistic Monitoring Design

3.2 Field Sampling and Data Collection Methods

Field data and samples were collected in accordance with existing SWAMP-comparable methods and procedures, as described in the RMC QAPP (BASMAA, 2016a) and the associated SOPs (BASMAA, 2016b). The SOPs were developed using a standard format describing health and safety cautions and considerations, relevant training, site selection, and sampling methods/procedures. Sampling methods/procedures include pre-fieldwork mobilization activities to prepare equipment, sample collection, and demobilization activities to preserve and transport samples, as well as to avoid transporting invasive species between creeks. The SOPs relevant to the monitoring discussed in this report are listed in Table 3.2.

Procedures for sample container size and type, preservative type, and associated holding times for each regional/probabilistic analyte are described in RMC SOP FS-9 (BASMAA, 2016b). Procedures for completion of field data sheets are provided in RMC SOP FS-10, and procedures for sample bottle labeling are described in RMC SOP FS-11 (BASMAA, 2016b).

Table 3.2 RMC Standard Operating Procedures Pertaining to Regional Creek Status Monitoring

SOP	Procedure
FS-1	BMI and algae bioassessments and physical habitat assessments
FS-2	Water quality sampling for chemical analysis, pathogen indicators, and toxicity testing
FS-3	Field measurements, manual
FS-6	Collection of bedded sediment samples
FS-7	Field equipment cleaning procedures
FS-8	Field equipment decontamination procedures
FS-9	Sample container, handling, and chain-of-custody procedures
FS-10	Completion and processing of field data sheets
FS-11	Site and sample naming convention
FS-12	Ambient creek status monitoring site evaluation
FS-13	QA/QC data review

3.2.1 Bioassessments

In accordance with the RMC QAPP (BASMAA, 2016a), bioassessments were conducted during the spring index period (approximately April 15 to July 15) and at a minimum of 30 days after any significant storm (roughly defined as at least 0.5 inch of rainfall within a 24-hour period).

Each bioassessment monitoring site consisted of an approximately 150-meter stream reach divided into 11 equidistant transects placed perpendicular to the direction of flow. The sampling position within each transect alternated between 25, 50 and 75 percent distance of the wetted width of the stream (see SOP FS-1, BASMAA, 2016b).

3.2.1.1 Benthic Macroinvertebrates (BMI)

BMIs were collected via kick net sampling using the reach-wide benthos (RWB) method described in RMC SOP FS-1 (BASMAA, 2016b), based on the SWAMP bioassessment procedures (Ode et al., 2016a

and 2016b). Samples were collected from a one square foot area approximately one meter downstream of each transect. The benthos was disturbed by manually rubbing areas of coarse substrate, followed by disturbing the upper layers of finer substrate to a depth of 4 to 6 inches to dislodge any remaining invertebrates into the net. Slack water habitat procedures were used at transects with deep and/or slow-moving water. Material collected from the 11 subsamples was composited in the field by transferring the entire sample into one to two 1,000 mL wide-mouth jar(s), and the samples were preserved with 95 percent ethanol.

3.2.1.2 Algae

Filamentous algae and diatoms also were collected using the RWB method described in SOP FS-1 (BASMAA, 2016b), based on the SWAMP bioassessment procedures (Ode et al., 2016a and 2016b). Algae samples were collected synoptically with BMI samples. The sampling position within each transect was the same as used for BMI sampling, except algae samples were collected 6 inches upstream of the BMI sampling position and following BMI collection from that location. The algae were collected using a range of methods and equipment, depending on the substrate occurring at the site (e.g., erosional, depositional, large and/or immobile) per RMC SOP FS-1. Erosional substrates included any material (substrate or organics) small enough to be removed from the stream bed, but large enough to isolate an area equal to a rubber delimiter (12.6 cm² in area).

When a sample location along a transect was too deep to sample, a more suitable location was selected, either on the same transect or from one further upstream. Algae samples were collected at each transect prior to moving on to the next transect. Sample material (substrate and water) from all 11 transects was combined in a sample bucket, agitated, and a suspended algae sample was then poured into a 500 mL cylinder, creating a composite sample for the site. A 45 mL subsample was taken from the algae composite sample and combined with 5 mL glutaraldehyde into a 50 mL sample tube for taxonomic identification of soft algae. Similarly, a 40 mL subsample was taken from the algae composite sample and combined with 10 mL of 10 percent formalin into a 50 mL sample tube for taxonomic identification of diatoms.

The algae composite sample also was used for collection of chlorophyll-a and ash-free dry mass (AFDM) samples following methods described in Fetscher et al. (2009). For the chlorophyll-a sample, 25 mL of the algae composite volume was removed and run through a glass fiber filter (47 mm, 0.7 µm pore size) using a filtering tower apparatus in the field. The AFDM sample was collected using a similar process which employs pre-combusted filters. Both filter samples were placed in Whirl-Pak® bags, covered in aluminum foil, and immediately placed on ice for transport to the analytical laboratory.

3.2.1.3 Physical Habitat (PHab)

Physical habitat (PHab) assessments were conducted during each BMI bioassessment monitoring event using the SWAMP PHab protocols (Ode et al., 2016a and 2016b) and RMC SOP FS-1 (BASMAA, 2016b). PHab data were collected at each of the 11 transects and 10 additional inter-transects (located between each main transect) by implementing the “Full” SWAMP level of effort (as prescribed in the MRP). At algae sampling locations, additional assessment of the presence of micro- and macroalgae was conducted during the pebble counts. In addition, water velocities were measured per SWAMP protocols at a single location in the sample reach (when possible).

3.2.2 Physicochemical Measurements

Dissolved oxygen, temperature, conductivity, and pH were measured during bioassessment monitoring using a multi-parameter probe (see SOP FS-3, BASMAA, 2016b). Dissolved oxygen, specific conductivity, water temperature, and pH measurements were made either by direct submersion of the instrument probe into the sample stream or by collection and immediate analysis of grab sample in the field. Water quality measurements were taken approximately 0.1m below the water surface at locations of the stream appearing to be completely mixed, ideally at the centroid of the stream. Measurements should occur upstream of sampling personnel and equipment and upstream of areas where bed sediments have been disturbed or prior to such bed disturbance.

3.2.3 Chlorine

Water samples were collected and analyzed for free and total chlorine using CHEMetrics test kits (K-2511 for low range and K-2504 for high range). Chlorine measurements in water were conducted during bioassessment monitoring and again during dry season monitoring for sediment chemistry, sediment toxicity, and water toxicity.

3.2.4 Nutrients and Conventional Analytes (Water Chemistry)

Water samples were collected for nutrient analyses using the standard grab sample collection method, as described in SOP FS-2 (BASMAA, 2016b) and associated with bioassessment monitoring. Sample containers were rinsed, as appropriate, using ambient water and filled and recapped below water surface whenever possible. An intermediate container was used to collect water for all sample containers with preservative added in advance by the laboratory. Sample container size and type, preservative type, and associated holding times for each analyte are described in Table 1 of FS-9 (BASMAA, 2016b). Syringe filtration method was used to collect samples for analyses of dissolved orthophosphate and dissolved organic carbon. All sample containers were labeled and stored on ice for transport to the analytical laboratory, except for analysis of AFDM and chlorophyll-a samples, which were field-frozen on dry ice by sampling teams, where appropriate.

3.2.5 Water Toxicity

Samples were collected using the standard grab sample collection method described above, filling the required number of labeled 2.25-liter amber glass bottles with ambient water, putting them on ice to cool to $4^{\circ}\text{C} \pm 2^{\circ}\text{C}$, and delivered to the laboratory within the required hold time. The laboratory was notified of the impending sample delivery to ensure meeting the 24-hour sample delivery time requirement. Procedures used for sample collection and transport are described in SOP FS-2 (BASMAA, 2016b).

3.2.6 Sediment Chemistry and Sediment Toxicity

In the case where sediment samples and water samples and measurements were collected at the same event, sediment samples were collected after water samples were collected. Before conducting sampling, field personnel surveyed the proposed sampling area to identify appropriate fine-sediment depositional areas to avoid disturbing possible sediment collection sub-sites. Personnel carefully entered the stream and began sampling at the closest appropriate reach, continuing upstream. Sediment samples were collected from the top 2 cm of sediment in a compositing container, thoroughly homogenized, and then aliquoted into separate jars for chemical and toxicological analysis using standard clean sampling techniques (see SOP FS-6, BASMAA, 2016b). Sample jars were submitted to the respective laboratories per SOP FS-9 (BASMAA, 2016b).

3.3 Laboratory Analysis Methods

RMC participants agreed to use the same set of analytical laboratories for regional/probabilistic parameters, developed standards for contracting with the labs, and coordinated quality assurance issues. All samples collected by RMC participants sent to laboratories for analysis were analyzed and reported per SWAMP-comparable methods, as described in the RMC QAPP (BASMAA, 2016a). The following analytical laboratory contractors were used for biological, chemical and toxicological analysis:

BioAssessment Services, Inc. – BMI taxonomic identification

The laboratory performed taxonomic identification nominally on a minimum of 600 BMI individuals for each sample, per standard taxonomic effort (STE) Level 1, as established by the Southwest Association of Freshwater Invertebrate Taxonomists, with additional identification of chironomids to subfamily/tribe level (corresponding to a Level 1a STE).

EcoAnalysts, Inc. – Algae taxonomic identification

Samples were processed in the laboratory following draft SWAMP protocols to provide count (diatom and soft algae), biovolume (soft algae), and presence (diatom and soft algae) data. Laboratory processing included identification and enumeration of 300 natural units of soft algae and 600 diatom valves to the lowest practical taxonomic level. Diatom and soft algae identifications were not fully harmonized with the California Algae and Diatom Taxonomic Working Group's Master Taxa List, and 12 taxa were not included in the data analysis.

Caltest Analytical Laboratory, Inc. – Water chemistry (nutrients, etc.), sediment chemistry, chlorophyll-a, AFDM

Upon receipt at the laboratory, samples were immediately logged and preserved as necessary. USEPA-approved testing protocols were then applied for analysis of water and sediment samples.

PHYSIS Environmental Laboratories, Inc. - Water chemistry (pyrethroids, imidacloprid, fipronil and degradates, total and dissolved organic carbon, and suspended sediment concentration)

Upon receipt at the laboratory, samples were immediately logged and preserved as necessary. USEPA-approved testing protocols were then applied for analysis of water samples, modified as necessary.

Pacific EcoRisk, Inc. – Water and sediment toxicity

Testing of water and sediment samples was performed per species-specific protocols published by USEPA.

3.4 Data Analysis

Only data collected by CCCWP during WY 2018 for regional/probabilistic parameters are presented and analyzed in this report. This includes data collected during bioassessment monitoring, including BMI and algae taxonomy, water chemistry, and physical habitat evaluations at 10 sites, as well as water and sediment toxicity and sediment chemistry data from one of those 10 sites. The bioassessment data are used to evaluate stream conditions, and the associated physical, chemical and toxicity testing data are then analyzed to identify potential stressors which may impact water quality and biological conditions. As the cumulative RMC sample sizes increase through monitoring conducted in future years, it will be possible to develop a statistically representative data set for the RMC region to address management questions related to condition of aquatic life.

Creek status monitoring data generated by CCCWP for local/targeted parameters (not included in the probabilistic design), per MRP provision C.8.d, are reported in *Local/Targeted Creek Status Monitoring Report: Water Year 2018*, found in Appendix 2 of the CCCWP WY 2018 UCMR (ADH, 2019).

The creek status monitoring results are subject to potential follow-up actions, per MRP provisions C.8.d and C.8.g, if they meet certain specified threshold triggers, as shown in Table 3.3 for the regional/probabilistic parameters. If monitoring results meet the requirements for follow-up actions as shown in Table 3.3, the results are compiled on a list for consideration as potential SSID projects, per MRP provision C.8.e, and used by RMC programs to help inform the SSID project selection process.

As part of the stressor assessment for this report, water and sediment chemistry and toxicity data generated during WY 2018 also were analyzed and evaluated against these threshold triggers to identify potential stressors which might contribute to degraded or diminished biological conditions.

In addition to those threshold triggers for potential SSID projects, the results are compared to other regulatory standards, including Basin Plan water quality objectives, where available and applicable.

Table 3.3 Requirements for Follow-up for Regional/Probabilistic Creek Status Monitoring Results Per MRP Provisions C.8.d and C.8.g

Constituent	Threshold Trigger Level	MRP 2.0 Provision	Provision Text
CSCI Score	< 0.795 (plus see provision text =>)	C.8.d.i.(8)	Sites scoring less than 0.795 per CSCI are appropriate for an SSID project, as defined in provision C.8.e. Such a score indicates a substantially degraded biological community relative to reference conditions. Sites where there is a substantial difference in CSCI score observed at a location relative to upstream or downstream sites are also appropriate for an SSID project. If many samples show a degraded biological condition, sites where water quality is most likely to cause and contribute to this degradation may be prioritized by the permittee for an SSID project.
Chlorine	> 0.1 mg/L	C.8.d.ii.(4)	The permittees shall immediately resample if the chlorine concentration is greater than 0.1 mg/L. If the resample is still greater than 0.1 mg/L, then permittees shall report the observation to the appropriate permittee central contact point for illicit discharges, so the illicit discharge staff can investigate and abate the associated discharge in accordance with provision C.5.e (Spill and Dumping Complaint Response Program).
Toxicity	TST "fail" on initial and follow-up sample test: both results have > 50 percent effect	C.8.g.iv	The permittees shall identify a site as a candidate SSID project when analytical results indicate any of the following: (1) a toxicity test of growth, reproduction, or survival of any test organism is reported as "fail" in both the initial sampling, and (2) a second, follow up sampling, and both have ≥ 50 percent effect. Note: Applies to dry and wet weather, water column and sediment tests.
Pesticides (Water) ¹	> Basin Plan WQO	C.8.g.iv	The permittees shall identify a site as a candidate SSID project when analytical results indicate a pollutant is present at a concentration exceeding its water quality objective in the Basin Plan.
Pesticides and Other Pollutants (Sediment)	Result exceeds PCE or TCE (per MacDonald et al., 2000)	C.8.g.iv	The permittees shall identify a site as a candidate SSID project when analytical results indicate any of the following: (1) A pollutant is present at a concentration exceeding its water quality objective in the Basin Plan; (2) for pollutants without WQOs, results exceed PEC or TEC.

Note: Per MRP provision C.8.d. and C.8.g., these are the data thresholds which trigger listings as candidate SSID projects, per MRP provision C.8.e.

¹ Per RMC decision, with Water Board staff concurrence, in accordance with MRP provision C.8.g.iii.(3), this monitoring commenced in WY 2018.

TEC threshold effects concentrations

PEC probable effects concentrations

3.4.1 Biological Data

The biological condition of each probabilistic site monitored by CCCWP in WY 2018 was evaluated principally through analysis of BMI and algal taxonomic metrics, and calculation of associated index of biological integrity (IBI) scores. An IBI is an analytical tool involving calculation of a site condition score based on a compendium of biological metrics.

3.4.1.1 Benthic Macroinvertebrate Data Analysis

Under MRP 2.0, the BMI taxonomic data are evaluated principally through calculation of the CSCI, a recently-developed bioassessment index (Rehn et al., 2015; Rehn, 2016; Mazor et al., 2016). The CSCI scores evaluate stream health based on comparison of the observed BMI taxonomy (as reported by the lab) versus the expected BMI community characteristics that would, in theory, be present in a reference stream with similar geographic characteristics as the monitored stream, based on a specific set of watershed parameters.

The CSCI score is computed as the average of two other indices: O/E, the observed (O) taxonomic diversity at the monitoring site divided by the taxonomic composition expected (E) at a reference site with similar geographical characteristics, and MMI, a multi-metric index incorporating several metrics reflective of BMI community attributes (such as measures of assemblage richness, composition, and diversity), as predicted for a site with similar physical characteristics. The six metrics selected for inclusion in the MMI calculations were taxonomic richness, number of shredder taxa, percent clinger taxa, percent Coleoptera taxa, percent EPT (Ephemeroptera, Plecoptera, and Trichoptera) taxa, and percent intolerant taxa (Rehn et al., 2015; Rehn, 2016).

CSCI scores run from a minimum of 0 (indicating no correspondence to modeled reference site conditions) to a maximum of 1 (perfect correspondence with modeled reference site conditions). A CSCI score below 0.795 indicates biological degradation and a potential candidate site for an SSID project, per MRP 2.0. This index produces conservative values relative to urban creeks.

Prior to the adoption of the first MRP, work was initiated on a San Francisco Bay Region B-IBI in a collaborative effort by BASMAA participants and others, and the results were provisionally tested in Contra Costa (CCCWP, 2007) and Santa Clara (SCVURPPP, 2007) Counties. The Contra Costa County version of the Bay Area B-IBI was subsequently used in analysis and reporting of BMI data over the course of several years for the annual Contra Costa Monitoring and Assessment Program (CCMAP) bioassessment monitoring (see summary, Ruby, 2012). Calculation of the preliminary Contra Costa B-IBI is also presented for CCCWP's BMI data in this report, to allow for comparisons with the historical CCMAP data set. For consistency and comparison with the 2012 regional UCMR (BASMAA, 2013), subsequent urban creeks monitoring reports, and other RMC programs, the Southern California B-IBI score (per Ode et al., 2005) is also computed for condition assessment in this report.

3.4.1.2 Algae Data Analysis

Algae taxonomic data are evaluated through a variety of metrics and indices. MRP 2.0 does not specify threshold trigger levels for algae data. Eleven diatom metrics, 11 soft algae metrics, and five algal IBIs (A-IBI; D18, H20, H21, H23 and S2) were calculated for this report following protocols developed from work in Southern California streams (Fetscher et al., 2013 and 2014). These A-IBIs were not tested for Bay Area waters; however, because the Southern California A-IBI D18 (per Fetscher et al., 2013 and 2014) relies only on diatoms and is thought to be more transferable to other areas of the state (Marco Sigala, personal communication), it was determined the D-18 A-IBI could be used provisionally for assessment of stream conditions for this report.

Diatom and soft algae metrics fall into five categories:

Tolerance/Sensitivity: association with specific water-quality constituents like nutrients; tolerance to low dissolved oxygen; tolerance to high-ionic-strength/saline waters

Autoecological Guild: nitrogen fixers; saprobic/heterotrophic taxa

Morphological Guild: sedimentation indicators; motility

Taxonomic Groups: Chlorophyta, Rhodophyta, Zygnemataceae, heterocystous cyanobacteria

Relationship to Reference sites

IBI scoring ranges and values were provided by Dr. A. Elizabeth Fetscher (Marco Sigala, personal communication). After each metric was scored, values were summed and then converted to a 100-point scale by multiplying the sum by the number of metrics (e.g., $\text{sum} \times [100/50]$ if five metrics included in the IBI).

3.4.2 Physical Habitat (PHab) Condition

Physical habitat condition was assessed for the bioassessment monitoring sites using “mini-PHab” scores. Mini-PHab scores range from 0 to 60, representing a combined score of three physical habitat sub-categories (epifaunal substrate/cover, sediment deposition, and channel alteration), each of which can be scored on a range of 0 to 20 points. Higher PHab scores reflect higher quality habitat.

The State of California (SWAMP) has developed a multi-metric index that can be used to characterize physical habitat condition for streams in California (Rehn et al., 2018a). The Index of Physical Habitat Integrity (IPI) is based on the concept that physical habitat characteristics have a profound effect on stream health, and that high-quality physical habitat is essential for maintaining beneficial uses. Interim instructions for calculating IPI using GIS and the analytical software platform, “R”, were published by SWAMP in 2018 (Rehn et al., 2018b). The IPI is calculated from empirical data organized into two input files: the “stations’ data, which are derived from the GIS characteristics associated with each monitoring site, and “PHab” data, which include about a dozen physical habitat characteristics culled from the bioassessment EDD produced from the physical habitat assessment, conducted as part of the bioassessment fieldwork. The State has provided guidance on four IPI score condition categories that can be used to facilitate interpretation of the calculated IPI scores. See details with discussion of results, section 4.3.1.

3.4.3 Water and Sediment Chemistry and Toxicity

As part of the stressor assessment for this report, water and sediment chemistry and toxicity data generated during WY 2018 were analyzed and evaluated to identify potential stressors that may contribute to degraded or diminished biological conditions. Results were evaluated in relation to MRP threshold triggers, and water chemistry results were evaluated with respect to applicable water quality objectives, where feasible.

For pesticides water chemistry data, a combination of published LC_{50} values from the literature and USEPA aquatic life benchmarks were used to calculate rough estimates of toxic unit (TU) equivalents, to provide a measure of the potential level of toxicity that could derive from the concentrations of toxic chemicals present in the sample.

The Central Valley Pyrethroid Pesticides TMDL specifies computation of "Pyrethroid Concentration Goal Units (CGUs)" to determine compliance with the TMDL limits (CVRWQCB, 2017). The CGUs reflect comparisons of measured pyrethroid concentrations (in water only) to the acute and chronic criteria established in the TMDL. CGU values greater than 1.0 indicate an exceedance. (This is similar to the TU equivalent calculations, which indicate potential pesticide-caused toxicity at $TU \geq 1$.) Calculation of the CGUs involve total organic carbon (TOC) and dissolved organic carbon (DOC) data, as the CGUs are based on the biologically-available dissolved fraction of the pesticides.

For sediment chemistry trigger criteria, comparisons to threshold effects concentrations (TECs) and probable effects concentrations (PECs) are calculated as defined in MacDonald et al. (2000). For each constituent for which there is a published TEC or PEC value, the ratio of the measured concentration to the respective TEC or PEC value was computed as the TEC or PEC quotient, respectively. All results where a TEC quotient was equal to or greater than 1.0 were identified. For each site, the mean PEC quotient was then computed, and any sites where mean PEC quotient was equal to or greater than 0.5 were identified.

Toxic unit equivalents also were computed for pyrethroid pesticides in sediment, based on available literature LC_{50} values (LC_{50} is the concentration of a chemical which is lethal on average to 50 percent of test organisms). Because organic carbon mitigates the toxicity of pyrethroid pesticides in sediments, the LC_{50} values were derived based on organic carbon-normalized pyrethroid concentrations. Therefore, the RMC pyrethroid concentrations reported by the lab also were divided by the measured TOC concentration at each site (as a percentage), and the TOC-normalized concentrations were then used to compute TU equivalents for each pyrethroid. For each site, the TU equivalents for the individual pyrethroids were summed, and sites where the summed TU equivalents were equal to or greater than 1.0 were identified.

3.5 Quality Assurance/Quality Control (QA/QC)

Data quality assurance and quality control (QA/QC) procedures are described in detail in the BASMAA RMC QAPP (BASMAA, 2016a) and in RMC SOP FS13, QA/QC Data Review (BASMAA, 2016b).

Data quality objectives (DQOs) were established to ensure the data collected were of sufficient quality for the intended use. DQOs include both quantitative and qualitative assessment of the acceptability of data. The qualitative goals include representativeness and comparability. The quantitative goals include completeness, sensitivity (detection and quantitation limits), precision, accuracy, and contamination. To ensure consistent and comparable field techniques, pre-monitoring field training and *in situ* field assessments were conducted.

Data were collected per the procedures described in the relevant SOPs (BASMAA, 2016b), including appropriate documentation of data sheets and samples, and sample handling and custody. Laboratories providing analytical support to the RMC were selected based on demonstrated capability to adhere to specified protocols.

All data were thoroughly reviewed by the programs responsible for collecting them, for conformance with QAPP requirements, and review of field procedures for compliance with the methods specified in the relevant SOPs. Data review was performed per protocols defined in RMC SOP FS13, QA/QC Data Review (BASMAA, 2016b). Data quality was assessed, and qualifiers were assigned, as necessary, in accordance with SWAMP requirements.

4 Results and Discussion

4.1 Statement of Data Quality

The RMC established a set of guidance and tools to help ensure data quality and consistency implemented through the collaborating programs. Additionally, the RMC participants continue to meet and coordinate on an ongoing basis to plan and coordinate monitoring, data management, and reporting activities, among others.

A comprehensive QA/QC program was implemented by each of the RMC programs, each of which is solely responsible for the quality of the data submitted on its behalf, covering all aspects of the regional/probabilistic monitoring. In general, QA/QC procedures were implemented as specified in the RMC QAPP (BASMAA, 2016a), and monitoring was performed per protocols specified in the RMC SOPs (BASMAA, 2016b) and in conformity with SWAMP protocols. QA/QC issues noted by the laboratories and/or RMC field crews are summarized below.

4.1.1 Bioassessment

Field duplicate BMI samples were collected at Wildcat Creek (206R02343). An analysis of the comparative results produced the following:

- The average relative percent difference (RPD) between the duplicate samples for 21 individual BMI metrics was 18 percent
- The CSCI and component scores produced for this duplicate data set produced a relative percent difference of 12 percent

Both sets of RPD results are considered to represent an acceptable level of variation between duplicate sets of taxonomic data.

Taxonomic procedures for BMI identification and enumeration included components identified in the QAPP:

- Minimum 600 organism subsample when possible.
- Sorting measurement quality objective: a check of remnants for organisms missed by original subsampler
- Interlaboratory quality control: submission of 10 percent of processed samples (one sample for this project) to an independent lab for review of taxonomic accuracy/precision and conformance to standard taxonomic level

The sample from the upstream Marsh Creek site (544R01993) contained low density of BMI organisms; total count from that sample was 276 individuals, below the minimum threshold specified in the QAPP.

The New Zealand mudsnail (*Potamopyrgus antipodarum*), a non-native invasive species, was confirmed at three sites: Wildcat, Grayson and San Ramon Creeks.

The interlaboratory quality control review revealed minor discrepancies in the BMI counts at the selected site (Pinole Creek); the slight correction was reflected in the final EDD used in the data analysis.

4.1.2 Sediment Chemistry

A number of quality control issues were reported by the laboratory (Caltest) for the sediment sample analyses (Marsh Creek, site 544R01737):

Method blank hits for the metals chromium, copper, lead and nickel: the concentrations detected in the blank water samples were substantially lower than the concentrations detected in the environmental sample, generally by at least an order of magnitude, and are therefore not expected to have adversely affected the environmental sample results.

Matrix spike/Matrix spike duplicate (MS/MSD) results out of range for the metals chromium and zinc, the pesticides bifenthrin, fipronil, and fipronil sulfide, and several PAH compounds: these results were obtained using batch QA data from analysis of samples from another project; the lab control standard (LCS) and RPD results were generally within limits; data are flagged and appropriate comments inserted in data records, but results are considered acceptable.

4.1.3 Water Chemistry

A field duplicate stormwater sample was collected from West Branch Alamo Creek (204R01412) on January 8, 2018 and analyzed for water chemistry (principally pesticides). The RPD results were all less than 10 percent for the pesticides analyzed, with the exception of imidacloprid, for which the RPD was 15.5 percent. These RPD values indicate acceptable precision from field collection and laboratory analysis.

Field duplicate samples were collected for water quality analysis as part of the bioassessment field work at Wildcat Creek (206R02343) on May 15, 2018. The average RPD between the duplicate samples for the 10 water quality analytes was less than 10 percent for all constituents except AFDM, a measure of algae abundance which is notoriously variable. The water quality RPD results are considered to represent an acceptable level of variation between duplicates.

Nitrate analysis was performed out of analytical holding time for multiple samples as reported by Caltest, the analytical laboratory.

4.1.4 Sediment Toxicity

No significant issues were reported in the laboratory analysis.

4.1.5 Water Toxicity

No significant issues were reported in the laboratory analysis.

One of the replicates in the dry weather water toxicity test with *Ceriodaphnia dubia* (Marsh Creek site 544R01737, sample collected July 17, 2018) was considered to be an outlier; the reported results for this test excluded the outlier replicate.

Pathogen-related mortality was not observed in any samples tested for WY 2018.

4.2 Biological Condition Assessment

Biological condition assessment addresses the RMC's core management question: what is the condition of aquatic life in creeks in the RMC area and are aquatic life beneficial uses supported? The designated

beneficial uses listed in the San Francisco Bay Region Basin Plan (SFBRWQCB, 2015) for RMC creeks monitored by CCCWP for bioassessment in WY 2018 are shown in Table 4.1.

The five-year bioassessment report in Appendix 8 of the Urban Creeks Monitoring Report provides additional analysis at the countywide program and regional levels, as well as comparisons between urban and non-urban land use sites.

Table 4.1 Designated Beneficial Uses Listed in the San Francisco Bay Region Basin Plan or CCCWP Bioassessment Sites Monitored in Water Year 2018

Site Code	Creek Name	Human Consumptive Uses							Aquatic Life Uses							Recreational Uses			
		AGR	MUN	FRSH	GWR	IND	PROC	COMM	SHELL	COLD	EST	MAR	MIGR	RARE	SPWN	WARM	WILD	REC-1	REC-2
204R02068	South San Ramon Creek ¹														E	E	E	E	
206R01495	Pinole Creek								E			E	E	E	E	E	E	E	
206R02203	Lauterwasser Creek			E											E	E	E	E	
206R02343	Wildcat Creek											E		E	E	E			E
207R01600	Mt. Diablo Creek								E			E	E	E	E	E	E	E	
207R01899	Mitchell Creek								E			E	E	E	E	E	E	E	
207R02315	Grayson Creek								E			E	E		E	E	E	E	
207R04027	Pine Creek								E			E	E	E	E	E	E	E	
544R01737	Marsh Creek							E					E		E	E	E	E	
544R01993	Marsh Creek							E					E		E	E	E	E	

Note: Per Basin Plan Ch. 2 (SFBRWQCB, 2015), beneficial uses for freshwater creeks include municipal and domestic supply (MUN), agricultural supply (AGR), industrial process supply (PRO), groundwater recharge (GWR), water contact recreation (REC1), noncontact water recreation (REC2), wildlife habitat (WILD), cold freshwater habitat (COLD), warm freshwater habitat (WARM), fish migration (MIGR), and fish spawning (SPWN). The San Francisco Bay Estuary supports estuarine habitat (EST), industrial service supply (IND), and navigation (NAV) in addition to all the uses supported by streams. Coastal waters' beneficial uses include water contact recreation (REC1); noncontact water recreation (REC2); industrial service supply (IND); navigation (NAV); marine habitat (MAR); shellfish harvesting (SHELL); ocean, commercial and sport fishing (COMM); and preservation of rare and endangered species (RARE).

- 1 Tributary to Alamo Creek in Alameda County
- E existing beneficial use
- P potential beneficial use

4.2.1 Benthic Macroinvertebrate Metrics

BMI taxonomic metrics are shown in Table 4.2 for the CCCWP creek status sites monitored in the spring index period of WY 2018. For consistency with the 2012 regional UCMR, subsequent urban creeks monitoring reports, and other RMC programs, the SoCal B-IBI score is included in the condition assessment analysis in this report. The preliminary Contra Costa B-IBI also is reported for purposes of comparison with the extensive historical database of bioassessment data produced by CCCWP during 2001-2011, as well as recent urban creeks monitoring reports. The condition category based on the Contra Costa B-IBI score is also shown for each bioassessment site at the bottom of Table 4.2.

CSCI scores were computed from the BMI taxonomy data and site-specific watershed characteristics for each bioassessment monitoring site. The CSCI score is computed as the average of the observed-to-expected score (O/E; the observed taxonomic diversity at the monitoring site divided by the taxonomic

composition expected at a reference site with similar geographical characteristics), and the MMI score (a multi-metric index incorporating several metrics reflective of BMI community attributes, such as measures of assemblage richness, composition, and diversity, as predicted for a site with similar physical characteristics). CSCI scores run from a minimum of 0 (indicating no correspondence to modeled reference site conditions) to a maximum of 1 (perfect correspondence with modeled reference site conditions). Per the MRP, a CSCI score of less than 0.795 is degraded, and should be evaluated for consideration as a possible SSID study location.

The essential results of the CSCI calculations are presented in Table 4.3. As shown in Table 4.3, every CCCWP bioassessment site monitored in WY 2018 produced a CSCI score below the MRP threshold of 0.795, indicating a degraded biological community relative to reference conditions. These sites consequently may be listed as potential candidates for SSID studies.

The WY 2018 CSCI scores ranged from a low of 0.299 at Marsh Creek (site 544R01993) to a high of 0.688 at Pinole Creek (site 206R01495).

Table 4.2 Benthic Macroinvertebrate Metrics for CCCWP Bioassessment Sites Monitored in Water Year 2018

BMI Metrics for CCCWP Bioassessment Sites, Spring 2018										
Site Code:	204R02068	206R01495	206R02203	206R02343	207R01600	207R01899	207R02315	207R04027	544R01737	544R01993
Creek Name:	San Ramon	Pinole	Lauterwasser	Wildcat	Mt. Diablo	Mitchell	Grayson	Pine	Marsh	Marsh
Richness:										
Taxonomic	19	25	19	23	13	22	20	26	20	13
EPT	3	6	5	4	0	6	2	7	1	0
Ephemeroptera	1	2	1	3	0	4	2	3	0	0
Plecoptera	0	0	1	1	0	0	0	2	0	0
Trichoptera	2	4	3	0	0	2	0	2	1	0
Coleoptera	0	1	0	4	0	2	0	3	0	0
Predator	3	9	6	8	2	6	6	10	4	2
Diptera	6	8	9	8	8	8	4	10	4	6
Composition:										
EPT Index (%)	14	17	22	2.4	0.0	23	0.8	9.5	0.2	0.0
Sensitive EPT Index (%)	13	11	5.5	0.2	0.0	1.6	0.0	1.5	0.2	0.0
Shannon Diversity	2.00	2.39	1.94	1.57	1.39	1.79	1.80	2.33	1.87	1.51
Dominant Taxon (%)	29	19	35	63	42	41	33	20	36	44
Non-insect Taxa (%)	42	28	21	30	31	27	50	19	65	54
Tolerance:										
Tolerance Value	6.2	5.8	5.5	5.9	5.9	5.5	6.7	6.5	7.4	6.1
Intolerant Organisms (%)	0.0	11	5.5	0.2	0.8	1.4	0.0	2.0	0.0	0.0
Intolerant Taxa (%)	0.0	8.0	11	4.3	7.7	18.2	0.0	15.4	0.0	0.0
Tolerant Organisms (%)	35	29	1.5	5.2	3.8	16	44	38	70	34
Tolerant Taxa (%)	37	32	16	22	31	32	55	27	45	23
Functional Feeding Groups:										
Collector-Gatherers (%)	78	52	53	87	95	83	61	58	34	63
Collector-Filterers (%)	0.2	15	35	3.2	0.2	10	1.0	0.5	1.9	0.0
Scrapers (%)	4.3	0.2	0.0	3.2	2.3	2.6	0.7	24	60	36

Table 4.2 Benthic Macroinvertebrate Metrics for CCCWP Bioassessment Sites Monitored in Water Year 2018

BMI Metrics for CCCWP Bioassessment Sites, Spring 2018										
Site Code:	204R02068	206R01495	206R02203	206R02343	207R01600	207R01899	207R02315	207R04027	544R01737	544R01993
Creek Name:	San Ramon	Pinole	Lauterwasser	Wildcat	Mt. Diablo	Mitchell	Grayson	Pine	Marsh	Marsh
Predators (%)	3.9	21	5.5	7.0	2.5	3.2	37	16	2.6	1.3
Shredders (%)	0.0	11.3	5.5	0.2	0.0	0.6	0.0	0.0	0.0	0.0
Other (%)	13.3	0.8	0.5	0.0	0.0	0.2	0.7	1.3	1.5	0.0
Estimated Abundance:										
Composite Sample (11 ft ²)	1,146	6,380	5,650	5,040	4,832	6,677	871	9,728	2,472	306
#/ft ²	104	580	514	458	439	607	79	884	225	28
#/m ²	1,113	6,194	5,486	4,893	4,691	6,483	846	9,445	2,400	297
Supplemental Metrics:										
Collectors (%)	79	21	88	82	97	88	87	85	98	70
Non-Gastropoda Scrapers (%)	0.0	0.0	0.0	0.0	0.0	0.0	0.0	0.0	0.0	0.8
Shredder Taxa (%)	6.7	0.0	0.0	0.0	0.0	0.0	0.0	0.0	0.0	0.0
Diptera Taxa ^a	10	3	2	4	7	3	3	6	6	7
IBI Scores:										
SoCal IBI Score	13	40	34	36	11	27	19	53	16	19
CC B-IBI Score	31	43	35	33	21	33	28	46	22	25
CC B-IBI Category	Fair	Very Good	Good	Fair	Marginal	Fair	Fair	Very Good	Marginal	Fair

Note: Metrics are calculated from standard classifications, based on level I standard taxonomic effort, except Chironomids, which are identified to subfamily/tribe. Standard taxonomic effort source: Southwest Association of Freshwater Invertebrate Taxonomists (http://www.waterboards.ca.gov/swamp/docs/safit/ste_list.pdf).

The CC B-IBI scoring ranges for the condition categories are as follows: Poor: 0-10; Marginal: 11-22; Fair: 23-34; Good: 35-42; Very Good: 43-50

a Calculated based on Chironomids identified to family level

Table 4.3 Results of CSCI Calculations for Water Year 2018 CCCWP Bioassessment Sites

Site Code	Creek Name	Sample Date	BMI Count	O/E	MMI	CSCI
204R02068	San Ramon	05/31/18	609	0.421	0.296	0.359
206R01495	Pinole	05/29/18	639	0.889	0.486	0.688
206R02203	Lauterwasser	05/30/18	618	0.718	0.365	0.541
206R02343	Wildcat	05/15/18	630	0.829	0.489	0.659
207R01600	Mt. Diablo	05/14/18	604	0.482	0.178	0.330
207R01899	Mitchell	05/14/18	626	0.798	0.504	0.651
207R02315	Grayson	05/30/18	610	0.388	0.242	0.315
207R04027	Pine	05/17/18	608	0.758	0.566	0.662
544R01737	Marsh	05/16/18	618	0.497	0.227	0.362
544R01993	Marsh	05/16/18	276	0.448	0.150	0.299

Note: CSCI scores less than 0.795 indicate a substantially degraded biological community relative to reference conditions, and such sites are candidates for SSID projects.

4.2.2 Algae Metrics

Soft algae and diatom taxonomy samples were collected at 10 sites in Contra Costa county in calendar year 2018, as part of the RMC program. Samples (including a field duplicate at site 206R02343) were collected following the SWAMP Bioassessment Wadable Streams Protocol (Ode et al., 2016). Samples were processed in the laboratory following SWAMP protocols by EcoAnalysts (Stancheva et al., 2015) to provide count (diatom and soft algae), biovolume (soft algae), and “presence” (diatom and soft algae) data. Diatom and soft algae identifications matched the California Algae and Diatom Taxonomic Working Group’s Master Taxa List, and all “FinalIDs” were included in the calculations.

Eleven diatom metrics, 11 soft algae metrics, and five IBIs (D18, H20, H21, H23, and S2) were calculated following work performed on Southern California streams (Fetscher et al., 2013 and 2014). Diatom and soft algae metrics fall into five categories:

- Tolerance/sensitivity: association with specific water-quality constituents like nutrients; tolerance to low dissolved oxygen; tolerance to high-ionic-strength/saline waters
- Autecological guild: nitrogen fixers; saprobic/heterotrophic taxa
- Morphological guild: sedimentation indicators; motility
- Taxonomic groups: Chlorophyta, Rhodophyta, Zygnemataceae, heterocystous cyanobacteria
- Relationship to reference sites

IBI scoring ranges and values were provided by Dr. A. Elizabeth Fetscher (personal communication). After each metric was scored, values were summed and then converted to a 100-point scale by multiplying the sum by the number of metrics (e.g., sum x [100/50] if five metrics included in the IBI). IBIs are not calculated for field duplicates per the setup of the SWAMP Reporting Module.

The five calculated A-IBI scores are shown in summary in Table 4.4 for each bioassessment site monitored in WY 2018, with the highest and lowest scores highlighted for each of the IBIs. A discussion of the results for each of the five IBIs follows.

Table 4.4 Algal-IBI Scores for the Diatom (D18), Soft Algae (S2) and Hybrid (H20, H21, H23) Indices for Contra Costa Stations Sampled in 2018

Site Code	Creek Name	Sample Date	D18 A-IBI Score	S2 A-IBI Score	H20 A-IBI Score	H21 A-IBI Score	H23 A-IBI Score
204R02068	San Ramon	05/31/18	56	18	35	54	49
206R01495	Pinole	05/29/18	24	0	15	17	15
206R02203	Lauterwasser	05/30/18	44	18	29	34	31
206R02343	Wildcat	05/15/18	36	7	28	26	28
207R01600	Mt. Diablo	05/14/18	16	0	10	14	10
207R01899	Mitchell	05/14/18	72	0	45	51	45
207R02315	Grayson	05/30/18	32	22	29	24	26
207R04027	Pine	05/17/18	28	32	18	44	41
544R01737	Marsh	05/16/18	32	5	20	24	24
544R01993	Marsh	05/16/18	30	25	18	41	38
Average			53	8	37	13	25

Note: Highest score for each A-IBI is highlighted in green

D18 diatom IBI #18

S2 soft algae IBI #2

H20 hybrid algae IBI #20

H21 hybrid algae IBI #21

H22 hybrid algae IBI #22

(d) diatom

(s) soft algae, further defined as:

(sp) species counts

(b) biovolume

(m) mean of the species results

The average D18 diatom IBI score across all 10 Contra Costa sites was 53, higher than previous years. The highest D18 score (72) occurred at Mitchell Creek (site 207R01899), while Mt. Diablo Creek (site 207R01600) had the lowest score at 16 (Table 4.5). Higher scores tended to be associated with a lower proportion of halobiontic species, nitrogen heterotrophic species, and sediment tolerant, highly motile species, but with a higher proportion of species requiring greater than 50 percent dissolved oxygen saturation (Tables 4.5 and 4.6), which is consistent with previous years. Seven of 10 sites scored 1 and the other three sites scored 2 to 4 for the proportion of diatom species indicative of low total phosphorous levels, suggesting phosphorous is not a limiting factor in these streams. The proportion of diatom species requiring greater than 50 percent DO saturation exceeded 0.73 at nine sites, but the proportion of species requiring nearly 100 percent DO saturation dropped to below 0.25 for eight sites, suggesting lower DO levels in the 50 to 75 percent range compared to near 100 percent consistently. *Nitzschia spp*, *Cocconeis spp*, and *Planothidium frequentissimum* were the dominant diatom species found at nine of the ten sites, although no single species represented more than 37 percent of any sample. *Navicula gregaria* (24.7 percent) and *P. frequentissimum* (16.2 percent) were the dominant diatom species at the lowest scoring site (207R01600). Fetscher et al. (2013 and 2014) found the diatom IBI (D18) to be responsive to stream order, watershed area, and percent fines, so these values could also play a role in the D18 IBI scores.

The S2 soft algae IBI had an average score of 12.7 in 2018, compared to the average score of 27.2 in years 2014 through 2017 and the low average of 7.7 in 2017. The highest 2018 S2 score (32) occurred at Pine Creek (site 207R04027), while five sites scored 7 or lower, including three sites with a 0 score

(Table 4.7). Site 207R04027 scored higher because it had a higher proportion of ZHR taxa (*Zygnemataceae*, heterocystous cyanobacteria, *Rhodophyta*) and fewer soft algae species belonging to the green algae CRUS (*Cladophora glomerata*, *Rhizoclonium hieroglyphicum*, *Ulva flexuosa*, and *Stigeoclonium spp*; see Tables 4.7 and 4.8). In contrast, sites with lower S2 scores were dominated by taxa belonging to CRUS, which are typically indicative of high copper and DOC concentrations, and no ZHR taxa. This result is a little deceiving because SWAMP has not updated the algae attribute list since March 2013, and some Final IDs (e.g., *Heteroleibleinia* or *Leptolyngbya*) have not been assigned trait characteristics for copper or DOC, so they are not included in the calculations. All 10 sites had zero species indicative of low total phosphorous concentrations. The soft algae biovolume at seven sites was dominated by *Cladophora glomerata* (greater than 98 percent), while species richness was dominated by *Heteroleibleinia spp*, *Chamaesiphon*, or *Leptolyngbya* (note, three sites did not have algae in the count samples). Fetscher et al. (2013 and 2014) found soft algae IBIs were most responsive (negatively) to canopy cover and slope.

The hybrid IBIs (H20, H21 and H23), consisting of both soft algae and diatom metrics, produced similar results in determining the higher scores (sites 204R02068 and 207R01899) and lower scores (sites 206R01495 and 207R01600) (see Tables 4.9 through 4.11). However, the average IBI score varied slightly among the three hybrid IBIs (H20 = 24.7, H21 = 32.9, and H23 = 30.7). The main differences in the H20 IBI scores were due to the proportion of halobiontic and low TN diatoms, highly motile diatoms, heterotroph diatoms, and diatoms requiring greater than 50 percent dissolved oxygen saturation. H21 and H23 IBI scores were driven by the proportion of halobiontic diatoms, diatoms requiring greater than 50 percent dissolved oxygen saturation, and sediment tolerant, highly motile diatoms. Fetscher et al. (2013 and 2014) designated H20 as the overall top-performing IBI for Southern California streams, although differences with H23 were not pronounced. H21 and H23 scores have scored closer together in the current and previous years for Contra Costa streams.

Mitchell Creek (site 207R01899) scored 0 for the S2 IBI, indicating that the diatom community produced the higher D18 and hybrid scores for that site. Mt. Diablo Creek (site 207R01600) had among the lowest scores for all five IBIs, with an additional two sites also scoring 0 for the S2 IBI. The proportion of diatom and algae species indicative of low TP concentrations was low or nonexistent at all 10 sites, suggesting elevated levels of phosphorous. The presence of halobiontic, dissolved oxygen sensitive, and sediment tolerant, highly motile diatom species affected scores across the five IBIs, suggesting the importance of low ionic strength (low salinity), dissolved oxygen concentrations, and sediment qualities on a stronger diatom community. Soft algae scores were affected by the proportion of taxonomic groups and lack of species found within sites, indicating an impacted community for all sites. It is difficult to assess the contribution of some metrics, since the lack of assigned attributes in the database excludes new (since 2013) Final IDs from the calculations.

The ASCI (Algae Stream Condition Index) in development by SWAMP can be used in future assessments, as it will apply statewide and will be based on an updated attribute list.

Table 4.5 Diatom IBI (D18) and Individual Metric Scores for Contra Costa Stations Sampled in 2018

Site Code	Creek Name	Sample Date	D18 IBI Score	Proportion Halobiontic (d) Score	Proportion Low TP Indicators (d) Score	Proportion N Heterotrophs (d) Score	Proportion Requiring >50% DO Saturation (d) Score	Proportion Sediment Tolerant (Highly Motile) (d) Score
204R02068	San Ramon	05/31/18	56	7	4	6	6	5
206R01495	Pinole	05/29/18	24	0	1	6	3	2
206R02203	Lauterwasser	05/30/18	44	1	1	7	7	6
206R02343	Wildcat	05/15/18	36	5	1	3	5	4
207R01600	Mt. Diablo	05/14/18	16	2	1	2	0	3
207R01899	Mitchell	05/14/18	72	8	2	8	9	9
207R02315	Grayson	05/30/18	32	5	1	4	3	3
207R04027	Pine	05/17/18	28	3	1	2	6	2
544R01737	Marsh	05/16/18	32	3	1	3	7	2
544R01993	Marsh	05/16/18	30	2	3	1	7	2

Note: Metric scores were assigned based on metric results, as shown in Table 4.6, using scoring ranges and values provided by Dr. A. Elizabeth Fetscher (personal communication). The overall IBI score was calculated by converting the sum of individual scores to a 100-point scale by summing the scores and multiplying by the number of metrics (sum x [100/50]).

D18	diatom IBI #18
S2	soft algae IBI #2
H20	hybrid algae IBI #20
H21	hybrid algae IBI #21
H22	hybrid algae IBI #22
(d)	diatom
(s)	soft algae, further defined as:
(sp)	species counts
(b)	biovolume
(m)	mean of the species results

Table 4.6 Diatom Metric Results for Contra Costa Stations Samples in 2018

Site Code	Sample Date	Proportion A Minutissimum (d)	Proportion Halobiontic (d)	Proportion Highly Motile (d)	Proportion Low TN Indicators (d)	Proportion Low TP Indicators (d)	Proportion N Heterotrophs (d)	Proportion oligo- & beta-Mesosaprobic (d)	Proportion poly- & eutrophic (d)	Proportion Requiring >50% DO Saturation (d)	Proportion Requiring Nearly 100% DO Saturation (d)	Proportion Sediment Tolerant (Highly Motile) (d)
204R02068	05/31/18	0.198	0.15	0.245	0.289	0.316	0.207	0.663	0.589	0.867	0.395	0.257
206R01495	05/29/18	0	0.539	0.422	0.01	0.01	0.198	0.463	0.841	0.732	0.062	0.432
206R02203	05/30/18	0	0.507	0.172	0.015	0.021	0.142	0.743	0.964	0.902	0.028	0.189
206R02343	05/15/18	0.002	0.263	0.284	0.022	0.036	0.371	0.315	0.794	0.815	0.1	0.284
207R01600	05/14/18	0.02	0.435	0.349	0.037	0.04	0.396	0.214	0.861	0.475	0.067	0.359
207R01899	05/14/18	0.082	0.073	0.055	0.138	0.141	0.102	0.675	0.853	0.969	0.138	0.055
207R02315	05/30/18	0	0.247	0.347	0.028	0.028	0.288	0.589	0.539	0.751	0.471	0.367
207R04027	05/17/18	0.003	0.384	0.382	0.056	0.031	0.424	0.48	0.587	0.874	0.157	0.394
544R01737	05/16/18	0.022	0.382	0.411	0.043	0.05	0.344	0.514	0.715	0.882	0.214	0.422
544R01993	05/16/18	0.12	0.46	0.408	0.168	0.172	0.45	0.485	0.755	0.904	0.239	0.418

Note: All calculations based on count data; proportions are individual counts/total count for each sample

D18 diatom IBI #18

S2 soft algae IBI #2

H20 hybrid algae IBI #20

H21 hybrid algae IBI #21

H22 hybrid algae IBI #22

(d) diatom

(s) soft algae, further defined as:

(sp) species counts

(b) biovolume

(m) mean of the species results

Table 4.7 Soft Algae IBI (S2) and Individual Metric Scores for Contra Costa Stations Samples in 2018

Site Code	Creek Name	Sample Date	S2 IBI Score	Proportion High Cu Indicators (s, sp) Score	Proportion High DOC Indicators (s, sp) Score	Proportion Low TP Indicators (s, sp) Score	Proportion Non-Reference Indicators (s, sp) Score	Proportion Green Algae Belonging to CRUS (s, b) Score	Proportion ZHR (s, m) Score
204R02068	San Ramon	05/31/18	18	0	0	0	0	5	6
206R01495	Pinole	05/29/18	0	0	0	0	0	0	0
206R02203	Lauterwasser	05/30/18	18	1	0	0	7	1	2
206R02343	Wildcat	05/15/18	7	0	4	0	0	0	0
207R01600	Mt. Diablo	05/14/18	0	0	0	0	0	0	0
207R01899	Mitchell	05/14/18	0	0	0	0	0	0	0
207R02315	Grayson	05/30/18	22	3	4	0	5	1	0
207R04027	Pine	05/17/18	32	0	0	0	0	10	9
544R01737	Marsh	05/16/18	5	0	0	0	0	1	2
544R01993	Marsh	05/16/18	25	0	0	0	0	9	6

Note: The overall IBI score was calculated by converting the sum of individual scores to a 100-point scale by summing the scores and multiplying by the number of metrics (sum x [100/60]).

D18 diatom IBI #18

S2 soft algae IBI #2

H20 hybrid algae IBI #20

H21 hybrid algae IBI #21

H22 hybrid algae IBI #22

(d) diatom

(s) soft algae, further defined as:

(sp) species counts

(b) biovolume

(m) mean of the species results

Table 4.8 Soft Algae Metric Results for Contra Costa Stations Samples in 2018

Site Code	Sample Date	Proportion High Cu Indicators (s, sp)	Proportion High DOC Indicators (s, sp)	Proportion Low TP Indicators (s, sp)	Proportion Non-Reference Indicators (s, sp)	Proportion ZHR (s, sp)	Proportion Chlorophyta (s, b)	Proportion High DOC Indicators (s, b)	Proportion Non-Reference Indicators (s, b)	Proportion Green Algae Belonging to CRUS (s, b)	Proportion ZHR (s, b)	Proportion ZHR (s, m)
204R02068	05/31/18	1	1	0	1	0.25	0.503	1	1	0.503	0.497	0.374
206R01495	05/29/18	0.5	1	0	0.5	0	1	1	1	1	0	0
206R02203	05/30/18	0.333	0.833	0	0.167	0.125	0.982	1	1	0.982	0.018	0.071
206R02343	05/15/18	0.5	0.5	0	0.5	0	1	1	1	1	0	0
207R01600	05/14/18	0.5	1	0	0.75	0	0.778	1	0.778	1	0	0
207R01899	05/14/18	0.5	1	0	0.5	0	1	1	1	1	0	0
207R02315	05/30/18	0.25	0.5	0	0.25	0	0.998	1	1	0.993	0	0
207R04027	05/17/18	0.5	1	0	0.5	0.5	0	1	0	0	0.704	0.602
544R01737	05/16/18	0.5	1	0	0.667	0.25	0.996	1	0.996	0.996	0	0.125
544R01993	05/16/18	0.5	1	0	0.5	0.25	0.001	1	0.001	0.001	0.499	0.375

Note: Calculations based on either species counts (sp) or biovolume (b); proportion ZHR (s, m) was based on the mean of the species and biovolume results.

D18 diatom IBI #18

S2 soft algae IBI #2

H20 hybrid algae IBI #20

H21 hybrid algae IBI #21

H22 hybrid algae IBI #22

(d) diatom

(s) soft algae, further defined as:

(sp) species counts

(b) biovolume

(m) mean of the species results

Table 4.9 Hybrid (diatom and soft algae) IBI (H20) and Individual Metric Scores for Contra Costa Stations Samples in 2018

Site Code	Creek Name	Sample Date	H20 IBI Score	Proportion Halobiontic (d) Score	Proportion High Cu Indicators (s, sp) Score	Proportion High DOC Indicators (s, sp) Score	Proportion Low TN Indicators (d) Score	Proportion Low TP Indicators (s, sp) Score	Proportion N Heterotrophs (d) Score	Proportion Requiring >50% DO Saturation (d) Score	Proportion Sediment Tolerant (Highly Motile) (d) Score
204R02068	San Ramon	05/31/18	35	7	0	0	4	0	6	6	5
206R01495	Pinole	05/29/18	15	0	0	0	1	0	6	3	2
206R02203	Lauterwasser	05/30/18	29	1	1	0	1	0	7	7	6
206R02343	Wildcat	05/15/18	28	5	0	4	1	0	3	5	4
207R01600	Mt. Diablo	05/14/18	10	2	0	0	1	0	2	0	3
207R01899	Mitchell	05/14/18	45	8	0	0	2	0	8	9	9
207R02315	Grayson	05/30/18	29	5	3	4	1	0	4	3	3
207R04027	Pine	05/17/18	18	3	0	0	1	0	2	6	2
544R01737	Marsh	05/16/18	20	3	0	0	1	0	3	7	2
544R01993	Marsh	05/16/18	18	2	0	0	2	0	1	7	2

Note: The overall IBI score was calculated by converting the sum of individual scores to a 100-point scale by summing the scores and multiplying by the number of metrics (sum x [100/80]).

D18 diatom IBI #18

S2 soft algae IBI #2

H20 hybrid algae IBI #20

H21 hybrid algae IBI #21

H22 hybrid algae IBI #22

(d) diatom

(s) soft algae, further defined as:

(sp) species counts

(b) biovolume

(m) mean of the species results

Table 4.10 Hybrid (diatom and soft algae) IBI (H21) and Individual Metric Scores for Contra Costa Stations Sampled in 2018

Site Code	Creek Name	Sample Date	H21 IBI Score	Proportion Chlorophyta (s, b) Score	Proportion Halobiontic (d) Score	Proportion Low TP Indicators (d) Score	Proportion N Heterotrophs (d) Score	Proportion Requiring >50% DO Saturation (d) Score	Proportion Sediment Tolerant (Highly Motile) (d) Score	Proportion ZHR (s, b) Score
204R02068	San Ramon	05/31/18	54	5	7	4	6	6	5	5
206R01495	Pinole	05/29/18	17	0	0	1	6	3	2	0
206R02203	Lauterwasser	05/30/18	34	1	1	1	7	7	6	1
206R02343	Wildcat	05/15/18	26	0	5	1	3	5	4	0
207R01600	Mt. Diablo	05/14/18	14	2	2	1	2	0	3	0
207R01899	Mitchell	05/14/18	51	0	8	2	8	9	9	0
207R02315	Grayson	05/30/18	24	1	5	1	4	3	3	0
207R04027	Pine	05/17/18	44	10	3	1	2	6	2	7
544R01737	Marsh	05/16/18	24	1	3	1	3	7	2	0
544R01993	Marsh	05/16/18	41	9	2	3	1	7	2	5

Note: The overall IBI score was calculated by converting the sum of individual scores to a 100-point scale by summing the scores and multiplying by the number of metrics [sum x (100/70)]

D18 diatom IBI #18

S2 soft algae IBI #2

H20 hybrid algae IBI #20

H21 hybrid algae IBI #21

H22 hybrid algae IBI #22

(d) diatom

(s) soft algae, further defined as:

(sp) species counts

(b) biovolume

(m) mean of the species results

Table 4.11 Hybrid (diatom and soft algae) IBI (H23) and Individual Metric Scores for Contra Costa Stations Sampled in 2018

Site Code	Creek Name	Sample Date	H23 IBI Score	Proportion Halobiontic (d) Score	Proportion High DOC Indicators (s, sp) Score	Proportion Low TP Indicators (d) Score	Proportion N Heterotrophs (d) Score	Proportion Green Algae Belonging to CRUS (s, b) Score	Proportion Requiring >50% DO Saturation (d) Score	Proportion Sediment Tolerant (Highly Motile) (d) Score	Proportion ZHR (s, m) Score
204R02068	San Ramon	05/31/18	49	7	0	4	6	5	6	5	49
206R01495	Pinole	05/29/18	15	0	0	1	6	0	3	2	15
206R02203	Lauterwasser	05/30/18	31	1	0	1	7	1	7	6	31
206R02343	Wildcat	05/15/18	28	5	4	1	3	0	5	4	28
207R01600	Mt. Diablo	05/14/18	10	2	0	1	2	0	0	3	10
207R01899	Mitchell	05/14/18	45	8	0	2	8	0	9	9	45
207R02315	Grayson	05/30/18	26	5	4	1	4	1	3	3	26
207R04027	Pine	05/17/18	41	3	0	1	2	10	6	2	41
544R01737	Marsh	05/16/18	24	3	0	1	3	1	7	2	24
544R01993	Marsh	05/16/18	38	2	0	3	1	9	7	2	38

Note: The overall IBI score was calculated by converting the sum of individual scores to a 100-point scale by summing the scores and multiplying by the number of metrics (sum x (100/80)).

D18 diatom IBI #18

S2 soft algae IBI #2

H20 hybrid algae IBI #20

H21 hybrid algae IBI #21

H22 hybrid algae IBI #22

(d) diatom

(s) soft algae, further defined as:

(sp) species counts

(b) biovolume

(m) mean of the species results

4.3 Stressor Assessment

This section addresses the question: what are the major stressors to aquatic life in the RMC area? The biological, physical, chemical, and toxicity testing data produced by CCCWP during WY 2018 were compiled, evaluated, and analyzed against the threshold trigger criteria shown in Table 3.3. When the data analysis indicated the associated trigger criteria were exceeded, those sites and results were identified as potentially warranting further investigation.

When interpreting analytical chemistry results, it is important to account for laboratory data reported as either below method detection limits (MDLs) or between detection and reporting limits (RLs). Dealing with data in this range of the analytical spectrum introduces some level of uncertainty, especially when attempting to generate summary statistics for a data set. In the following compilation of statistics for analytical chemistry, in some cases non-detect data (ND) were substituted with a concentration equal to half of the respective MDL, as reported by the laboratory.

4.3.1 Physical Habitat Parameters

An array of physical habitat characteristics is recorded on the SWAMP field data sheets during bioassessment monitoring. A selected few are used to compile a “mini-PHab score”. The metrics included in calculation of the mini-PHab scores are summarized in Table 4.12 for bioassessment sites monitored in WY 2018. The Pinole, Lauterwasser, and Pine Creek sites had the highest mini-PHab scores, while the San Ramon, Grayson, and Marsh Creek sites had the lowest mini-PHab scores in 2018.

The California IPI score was calculated for Contra Costa bioassessment sites monitored in WY 2018, using the new SWAMP IPI protocols (Rehn et al., 2018b). During method development the IPI model was calibrated such that:

- the mean score of reference sites is 1
- scores near 0 indicate substantial departure from reference condition and serious degradation of physical condition
- scores greater than 1 indicate greater physical complexity than predicted for a site, given its natural environmental setting

The SWAMP IPI protocols established thresholds based on the 30th, 10th, and 1st percentiles of IPI scores at reference sites, to divide the IPI scoring range into four categories of physical condition as follows:

- $IPI \geq 0.94$ = likely intact condition
- $IPI 0.84$ to 0.93 = possibly altered condition
- $IPI 0.71$ to 0.83 = likely altered condition
- $IPI \leq 0.70$ = very likely altered condition

The IPI scores calculated from the 2018 PHab data, compiled from bioassessment monitoring conducted during spring, 2018, are shown in Table 4.13. The IPI scores produced two to three sites in each of the four IPI condition categories.

The IPI scores correspond well with the 2018 mini-PHab scores, as the creek sites with the top four IPI scores (Pinole, Lauterwasser, Pine and Mitchell) also are the sites with the top four mini-PHab scores,

while the creek sites with the three lowest IPI scores (San Ramon, Grayson and Marsh site 544R001993) are also the sites with the three lowest mini-PHab scores.

Table 4.12 Physical Habitat Metrics and Mini-PHab Scores for CCCWP Bioassessment Sites Monitored in Water Year 2018

Site Code	Creek Name	Sample Date	Epifaunal Substrate	Sediment Deposition	Channel Alteration	Mini-PHab Score
204R02068	San Ramon	05/31/18	7	11	2	20
206R01495	Pinole	05/29/18	16	14	15	45
206R02203	Lauterwasser	05/30/18	16	16	13	45
206R02343	Wildcat	05/15/18	11	11	6	28
207R01600	Mt. Diablo	05/14/18	9	11	14	34
207R01899	Mitchell	05/14/18	13	13	13	39
207R02315	Grayson	05/30/18	7	8	6	21
207R04027	Pine	05/17/18	16	15	14	45
544R01737	Marsh	05/16/18	9	6	7	22
544R01993	Marsh	05/16/18	6	8	6	20

Table 4.13 Index of Physical Habitat Integrity (IPI) Scores for CCCWP Bioassessment Sites Monitored in Water Year 2018

Site Code	Creek Name	Sample Date	IPI Score	IPI Category
204R02068	San Ramon	05/31/18	0.72	Likely altered
206R01495	Pinole	05/29/18	1.02	Likely intact
206R02203	Lauterwasser	05/30/18	0.94	Likely intact
206R02343	Wildcat	05/15/18	0.75	Likely altered
207R01600	Mt. Diablo	05/14/18	0.85	Possibly altered
207R01899	Mitchell	05/14/18	0.98	Likely intact
207R02315	Grayson	05/30/18	0.69	Very likely altered
207R04027	Pine	05/17/18	0.93	Possibly altered
544R01737	Marsh	05/16/18	0.90	Possibly altered
544R01993	Marsh	05/16/18	0.64	Very likely altered

4.3.2 Correlations of Biological and Physical Habitat Parameters

The principal biological and physical habitat condition scores are shown together in Table 4.14, and correlations between the key biological and physical habitat condition scores are shown in Table 4.15.

For the 2018 analysis, the benthic community indices (CSCI, CC B-IBI) correlated well with each other and with both of the PHab indices (Mini-PHab, IPI), and the two PHab indices correlated well with each other. The CC B-IBI also correlated well with the SoCal B-IBI. These results support the idea that there is a likely connection between stream physical habitat condition and benthic biological community health.

The two algal community indices (D18, H20) were well correlated with each other, but neither of the algal indices correlated well with any other factor, indicating that algae community composition may be influenced principally by factors other than physical habitat, and that algae communities are somewhat independent of benthic taxonomic characteristics.

Table 4.14 Summary of PHab and Biological Condition Scores for CCCWP Bioassessment Sites Monitored in Water Year 2018

Site Code	Creek Name	CSCI Score	D18 Algal IBI Score	H20 Algal IBI Score	CC IBI	Mini-PHab Score	IPI Score
204R02068	San Ramon	0.359	56	35	31	20	0.72
206R01495	Pinole	0.688	24	15	43	45	1.02
206R02203	Lauterwasser	0.541	44	29	35	45	0.94
206R02343	Wildcat	0.659	36	28	33	28	0.75
207R01600	Mt. Diablo	0.330	16	10	21	34	0.85
207R01899	Mitchell	0.651	72	45	33	39	0.98
207R02315	Grayson	0.315	32	29	28	21	0.69
207R04027	Pine	0.662	28	18	46	45	0.93
544R01737	Marsh	0.362	32	20	22	22	0.90
544R01993	Marsh	0.299	30	18	25	20	0.64

Table 4.15 Correlations for PHab and Biological Condition Scores for CCCWP Bioassessment Sites Monitored in Water Year 2018

Comparison	Correlation Coefficient	R Squared
CSCI:D18 A-IBI	0.22	0.048
CSCI:H20 A-IBI	0.20	0.039
CSCI:Contra Costa-IBI	0.83	0.681
CSCI:Mini-PHab	0.77	0.587
CSCI:IPI	0.67	0.452
D18 A-IBI:H20 A-IBI	0.95	0.91
D18 A-IBI:Contra Costa-IBI	0.10	0.009
D18 A-IBI:Mini-PHab	-0.02	0.00
D18 A-IBI:IPI	0.10	0.01
H20 A-IBI:Contra Costa-IBI	0.08	0.007
H20 A-IBI:Mini-PHab	-0.10	0.01
H20 A-IBI:IPI	-0.03	0.00
Contra Costa B-IBI:Mini-PHab	0.72	0.513
Contra Costa B-IBI:IPI	0.51	0.257
Contra Costa B-IBI:SoCal IBI	0.91	0.832
Mini-PHab:IPI	0.84	0.710

Note: Correlations are based on scores shown in Table 4.14. Well correlated results (correlated coefficient greater than 0.50) are highlighted in green.

4.3.3 Water Chemistry Parameters

At all 10 bioassessment sites, water samples were collected for nutrient and other conventional analyses using the standard grab sample collection method, as described in SOP FS-2 (BASMAA, 2016b). Standard field parameters (temperature, dissolved oxygen, pH, and specific conductance) were also measured in the field using a portable multi-meter and sonde.

Of the 12 water quality constituents monitored in association with the bioassessment monitoring, water quality standards or established thresholds are available only for ammonia (un-ionized form⁴), chloride⁵, and nitrate + nitrite⁶ – the latter for waters with MUN beneficial use only, as indicated in Table 4.16.

Table 4.16 Water Quality Thresholds Available for Comparison to Water Year 2018 Water Chemistry Constituents

Sample Parameter	Threshold	Units	Frequency/Period	Application	Source
Ammonia	0.025	mg/L	Annual Median	Un-ionized ammonia, as N (maxima also apply to Central Bay and u/s [0.16] and Lower Bay [0.4])	Basin Plan (Ch. 3)
Chloride	230	mg/L	Criterion Continuous Concentration	Freshwater aquatic life	USEPA National Recreation Water Quality Criteria, Aquatic Life Criteria
Chloride	860	mg/L	Criteria Maximum Concentration	Freshwater aquatic life	USEPA National Recreation Water Quality Criteria, Aquatic Life Criteria Table
Chloride	250	mg/L	Secondary Maximum Contaminant Level	Alameda Creek watershed above Niles and MUN waters; Title 22 drinking waters	SF Bay Basin Plan (Ch. 3); California Title 22; USEPA Drinking Water Standards Secondary MCL
Nitrate + Nitrite (as N)	10	mg/L	Maximum Contaminant Level	Areas designated as MUN	Basin Plan (Ch. 3)

The comparisons of the measured nutrients data to the thresholds listed in Table 4.16 are shown in Table 4.17. There were no exceedances of the applicable criteria for chloride or nitrate + nitrite at any of the 10 sites monitored in WY 2018, but there were four exceedances of the Basin Plan standard for unionized ammonia. This is a highly unusual result. The four samples were collected across three

⁴ For ammonia, the standard provided in the Basin Plan (SFBRWQCB, 2017, section 3.3.20) applies to the un-ionized fraction, as the underlying criterion is based on un-ionized ammonia, which is the more toxic form. Conversion of RMC monitoring data from the measured total ammonia to un-ionized ammonia was based on a formula provided by the American Fisheries Society, and calculates un-ionized ammonia in freshwater systems from analytical results for total ammonia and field-measured pH, temperature, and electrical conductivity (see: <http://fisheries.org/hatchery>).

⁵ For chloride, a Secondary Maximum Contaminant Level (MCL) of 250 mg/L applies to those waters with MUN beneficial use, per the Basin Plan (Table 3-5), Title 22 of the California Code of Regulations, and the USEPA drinking water quality standards, and applies per the Basin Plan (Table 3-7) to waters in the Alameda Creek watershed above Niles. For all other waters, the criteria maximum concentration water quality criterion of 860 mg/L (acute) and the Criterion Continuous Concentration (CCC) of 230 mg/L (USEPA Water Quality Criteria*) for the protection of aquatic life can be used for comparison. Per the UCMR for WY 2012 (BASMAA, 2012), the RMC participants used the 230 mg/L threshold as a conservative benchmark for comparison purposes for all locations not specifically identified within the Basin Plan (i.e., sites not within the Alameda Creek watershed above Niles nor identified as MUN, rather than the maximum concentration criterion of 830 mg/L).

*See: <http://water.epa.gov/scitech/swguidance/standards/criteria/current/index.cfm>

⁶ The nitrate + nitrite primary MCL applies to those waters with MUN beneficial use, per the Basin Plan (Table 3-5), Title 22 of the California Code of Regulations, and the USEPA Drinking Water Quality Standards.

separate dates, in four different watersheds, and were all analyzed on the same date by the lab, but further investigation did not reveal any clear evidence of laboratory error. These four results will be flagged as questionable in the database.

Table 4.17 Comparison of Water Quality (Nutrient) Data to Associated Water Quality Thresholds for Water Year 2018 Water Chemistry Results

Site Code	Creek Name	MUN?	Parameter and Threshold			Number of Parameters > Threshold/ Water Body
			Un-ionized Ammonia (as N)	Chloride	Nitrate + Nitrite (as N)	
			25 µg/L	230/250 mg/L ¹	10 mg/L ²	
204R02068	San Ramon	No	36.1	100	1.3	1
206R01495	Pinole	No	36.3	56	0.20	1
206R02203	Lauterwasser	No	65.1	150	0.22	1
206R02343	Wildcat	No	2.02	35	0.23	0
207R01600	Mt. Diablo	No	1.87	100	0.10	0
207R01899	Mitchell	No	2.21	30	0.19	0
207R02315	Grayson	No	43.9	130	0.066	1
207R04027	Pine	No	1.38	42	0.15	0
544R01737	Marsh	No	2.83	130	0.002	0
544R01993	Marsh	No	13.1	100	1.1	0
Number of Values > Threshold			4	0	0	4
Percent of Values > Threshold			40%	0%	0%	

1 250 mg/L threshold applies for sites with MUN beneficial use and Alameda Creek above Niles per Basin Plan

2 Nitrate + nitrite threshold applies only to sites with MUN beneficial use. No WY 2018 sites have MUN beneficial use.

Bolded values indicate results above applicable thresholds

Water samples also were collected and analyzed for free and total chlorine in the field using CHEMetrics test kits during bioassessment monitoring.

As shown in Table 4.18, no water samples produced measured levels of free or total chlorine above the threshold level of 0.08 mg/L. Total chlorine was detected at three sites (the Wildcat Creek site at 0.08 mg/L, and both Marsh Creek sites at 0.04 mg/L), while free chlorine also was detected (0.04 mg/L) at the Wildcat Creek site. The cause of the detected chlorine concentrations is unknown. All other sites were non-detect for chlorine.

Table 4.18 Summary of Chlorine Testing Results for Samples Collected in Water Year 2018 in Comparison to Municipal Regional Permit Trigger Criteria

Site Code	Creek Name	Sample Date	Chlorine, Free	Chlorine, Total	Exceeds Trigger Threshold?
204R02068	San Ramon	05/31/18	0.0	0.0	No
206R01495	Pinole	05/29/18	0.0	0.0	No
206R02203	Lauterwasser	05/30/18	0.0	0.0	No
206R02343	Wildcat	05/15/18	0.04	0.08	No
207R01600	Mt. Diablo	05/14/18	0.0	0.0	No
207R01899	Mitchell	05/14/18	0.0	0.0	No
207R02315	Grayson	05/30/18	0.0	0.0	No
207R04027	Pine	05/17/18	0.0	0.0	No
544R01737	Marsh	05/16/18	0.0	0.04	No
544R01993	Marsh	05/16/18	0.0	0.04	No
Number of Samples Exceeding 0.08 mg/L			0	0	
Percentage of Samples Exceeding 0.08 mg/L			0%	0%	

4.3.4 Water Column Toxicity and Chemistry (Wet Weather)

Stormwater samples were collected on January 8, 2018 from two monitoring sites in Contra Costa County (West Branch Alamo Creek, site 204R01412, and Marsh Creek, site 544R04613), and analyzed for a suite of pesticide compounds, as well as tested for toxicity to several different aquatic species, as required by the MRP. The wet weather water toxicity test results are shown in Table 4.19, and the associated chemistry analytical results are shown in Table 4.20.

TU equivalents were computed for pesticides chemistry data for both wet weather sample dates, based on published LC₅₀ values, where available, and using USEPA benchmarks where LC₅₀ values were not available (Table 4.20).

For the March 1 retest of the Marsh Creek (site 544R01737) sample, pyrethroid concentration goal units (CGUs) also were calculated as specified in the Central Valley Pyrethroid Pesticides TMDL (CVRWQCB, 2017). The CGU calculations require TOC and DOC data, which were not available for the January 8 stormwater samples. The CGUs reflect comparisons of the measured pyrethroid pesticide concentrations (in water) to the acute and chronic criteria established in the TMDL. CGU values greater than 1.0 indicate an exceedance for water bodies regulated by the TMDL in Central Valley Region 5. This is similar to the TU equivalent calculations, which indicate potential pesticide-caused toxicity at TU \geq 1.

Table 4.19 Summary of CCCWP Water Year 2018 Wet Season Water Toxicity Results

Wet Season Water Samples			Toxicity Test Results						
Site Code	Creek Name	Sample Collection Date	<i>S. capricornutum</i>	<i>C. dubia</i>		<i>C. dilutus</i>	<i>H. azteca</i>	<i>P. promelas</i>	
			Growth (cells/mL x 10 ⁶)	Survival (%)	Reproduction (No. of neonates/female)	Survival (%)	Survival (%)	Survival (%)	Growth (mg)
Lab Control			2.48	90	35.1	97.5	94	97.5	0.81
204R01412	West Branch Alamo Creek	01/08/18	5.13	100	33.2	97.5	70 ^a	97.5	0.76
544R04613	Marsh Creek	01/08/18	4.88	100	30.9	92.5	2.0 ^b	100	0.80
Lab Control							98		
544R04613	Marsh Creek (retest)	03/01/18					2.0 ^b		

- a The response at this test treatment was significantly less than the lab control treatment response at $p < 0.05$, and was determined to be toxic, but the test result did not meet the MRP aquatic toxicity threshold for follow-up (less than 50 percent of the control).
- b The response at this test treatment was significantly less than the lab control treatment response at $p < 0.05$, and was determined to be toxic, and the test result met the MRP aquatic toxicity threshold for follow-up (less than 50 percent of the control).

Table 4.20 CCCWP Water Year 2018 Wet Season Water Chemistry Results: Detected Pesticides and Calculated Toxic Unit Equivalents and Concentration Goal Units

Stormwater Samples – January 8, 2018 – W. Branch Alamo Creek (204R01412)			
Pyrethroid Pesticides	LC ₅₀ (ng/L)	Sample (ng/L)	TU Equiv.
Bifenthrin	7.5	17.2	2.3
Cyfluthrin	2.4		0.0
Cyhalothrin, lambda*	2.0		0.0
Cypermethrin	2.5		0.0
Deltamethrin*	4.1		0.0
Esfenvalerate	8.0		0.0
Permethrin	21.1		0.0
Sum (Pyrethroid Tus)			2.3
Fipronil & Degradates etc.	USEPA Benchmark	Sample (ng/L)	TU Equiv.
Fipronil	11	23.6	2.1
Fipronil Desulfinyl	10310	8.6	0.0
Fipronil Sulfide	110	2.4	0.0
Fipronil Sulfone	37	16	0.4
Imidacloprid	10	50.1	5.0
Sum (Fipronil etc. Tus)			7.6
Stormwater Samples – January 8, 2018 – Marsh Creek (544R04613)			
Pyrethroid Pesticides	LC ₅₀ (ng/L)	Sample (ng/L)	TU Equiv.
Bifenthrin	7.5	74.8	10.0
Cyfluthrin	2.4		0.0
Cyhalothrin, lambda*	2.0		0.0
Cypermethrin	2.5		0.0
Deltamethrin*	4.1		0.0
Esfenvalerate	8.0		0.0
Permethrin	21.1		0.0

Table 4.20 CCCWP Water Year 2018 Wet Season Water Chemistry Results: Detected Pesticides and Calculated Toxic Unit Equivalents and Concentration Goal Units

Fipronil & Degradates etc.			Sum (Pyrethroid Tus)
EPA Benchmark	Sample (ng/L)	TU Equiv.	
			10.0
Fipronil	11	48.8	4.4
Fipronil Desulfinyl	10310	15	0.0
Fipronil Sulfide	110	3.2	0.0
Fipronil Sulfone	37	21.3	0.6
Imidacloprid	10	70.1	7.0
Sum (Fipronil etc. Tus)			12.1
Stormwater Samples – March 1, 2018 – Marsh Creek (544R04613)			
Pyrethroid Pesticides	LC ₅₀ (ng/L)	Sample (ng/L)	TU Equiv.
Bifenthrin	7.5	24.4	3.3
Cyfluthrin	2.4		0.0
Cyhalothrin, lambda*	2.0		0.0
Cypermethrin	2.5		0.0
Deltamethrin*	4.1		0.0
Esfenvalerate	8.0		0.0
Permethrin	21.1		0.0
Sum (Pyrethroid Tus)			3.3
Fipronil & Degradates etc.			Sum (Fipronil etc. Tus):
EPA Benchmark	Sample (ng/L)	TU Equiv.	
			1.0
Fipronil	11	7.71	0.70
Fipronil Desulfinyl	10310	6.8	0.001
Fipronil Sulfide	110	0.935	0.01
Fipronil Sulfone	37	10.5	0.28
Imidacloprid	10		0.0
Sum (Fipronil etc. Tus):			1.0
Calculation of Pyrethroid Concentration Goal Units (CGUs)			
Pyrethroid Pesticide	[Pyrethroid]	Acute CGU	Chronic CGU
Bifenthrin	24.4	1.8	14
Cyfluthrin	0.0	0.0	0.0
Cypermethrin	0.0	0.0	0.0
Esfenvalerate	0.0	0.0	0.0
Lambda-cyhalothrin	0.0	0.0	0.0
Permethrin	0.0	0.0	0.0
TOC	7.62	CGU Sum = 1.8	14
DOC	6.37		

Note: Yellow-highlighted cells indicate results exceed permit trigger threshold.

TU equivalents and CGUs calculated for detected data only; CGUs could only be calculated for the March 1 sample

ND data are shown as 0.0

*Published water LC₅₀ not available; USEPA Aquatic Life Benchmark used

Both the West Branch Alamo Creek (site 204R01412) and Marsh Creek (site 544R04613) January 8 stormwater samples were toxic to *Hyalella azteca*, as indicated in Table 4.19. The Marsh Creek sample *Hyalella azteca* result was less than 50 percent of the lab control, and therefore required retesting.

Correspondingly, in the January 8, 2018 samples, per the TU calculations as indicated in Table 4.20, chemical analysis revealed toxic levels of bifenthrin, fipronil, and imidacloprid in both samples; in both cases any of those pesticides could have theoretically caused toxicity alone. The Marsh Creek sample TUs were substantially higher than the West Branch Alamo Creek TUs for those constituents.

In the March 1, 2018 retest sample from the Marsh Creek site, the measured bifenthrin concentration produced a calculated CGU ≥ 1 (=1.8) for the acute criterion, and well above 1 (=14) for the chronic criterion. All other pyrethroids were non-detect in the March 1, 2018 sample. That sample also was highly toxic to *Hyalella azteca*, as indicated in Table 4.19.

The bifenthrin TU equivalent (=3.3) that was calculated from the March 1, 2018 stormwater sample from the Marsh Creek site was sufficient to have caused the observed toxicity to *Hyalella azteca* in the March 1, 2018 sample.

The sum of TU equivalents for that site from fipronil + degradates also hit 1.0, indicating possible toxicity from those constituents.

Imidacloprid was not detected in the March sample from Marsh Creek.

4.3.5 Water Column Toxicity (Dry Weather)

Water samples were collected on July 17, 2018 from one regional/probabilistic monitoring site on West Branch Alamo Creek (site 204R01412), and tested for toxicity to several different aquatic species, as required by the MRP. The dry weather water toxicity test results are shown in Table 4.21. Water chemistry testing was not required for the dry season sample.

All of the dry weather water toxicity test results were determined not to be toxic.

The *Ceriodaphnia dubia* chronic water sample test included one replicate that was determined to be a statistical outlier, and the outlier replicate was excluded from the analysis.

Table 4.21 Summary of CCCWP Water Year 2018 Dry Season Water Toxicity Results

Dry Season Water Samples			Toxicity Test Results						
Site Code	Creek Name	Sample Collection Date	<i>S. capricornutum</i>	<i>C. dubia</i>	<i>C. dilutus</i>	<i>H. azteca</i>		<i>P. promelas</i>	
			Growth (cells/mL x 10 ⁶)	Survival (%)	Reproduction (No. of neonates/female)	Survival (%)	Survival (%)	Survival (%)	Growth (mg)
Lab Control			3.86	100	22.7	100	96	97.5	0.74
544R01737	Marsh Creek	07/17/18	7.96	100	38.2	90	100	95.0	0.73

Note: No test treatment was determined to be significantly less than the lab control treatment response at $p < 0.05$

4.3.6 Sediment Toxicity and Sediment Chemistry

Sediment samples were collected on July 17, 2018 after water samples were collected at the same regional/probabilistic monitoring site sampled for water column toxicity (Marsh Creek, site 544R01737), and tested for acute toxicity (survival) to *Hyalella azteca* and *Chironomus dilutus*.

The sediment sample was determined to be toxic to *Hyalella azteca*, but not to *Chironomus dilutus*. The sediment toxicity test results are shown in Table 4.22.

Table 4.22 Summary of CCCWP Water Year 2018 Dry Season Sediment Toxicity Results

Dry Season Sediment Samples			Toxicity Test Results	
Site Code	Creek Name	Sample Collection Date	<i>Hyalella azteca</i>	<i>Chironomus dilutus</i>
			Survival (%)	Survival (%)
Lab Control			92.5	82.5
544R01737	Marsh Creek	07/17/18	77.5 ^a	76.2

a The response at this test treatment was significantly less than the lab control treatment response at $p < 0.05$ and was determined to be toxic, but the test result was not less than 50 percent of the control.

The sediment sample also was tested for a suite of potential sediment pollutants, as required by the MRP, and the results were compared to the trigger threshold levels specified for follow-up in MRP provision C.8.g.iv. (see Table 3.3). The complete sediment chemistry results are shown in Table 4.23, and the results are shown in comparison to the applicable MRP threshold triggers in Table 4.24.

Sediment chemistry results (Tables 4.23 and 4.24) are summarized as follows:

- Only one constituent (nickel at 1.23) had a TEC ≥ 1.0 (nickel is a naturally occurring element throughout much of the San Francisco Bay area, and commonly occurs at elevated levels in creek status monitoring)
- Seven PAH compounds were detected, but at relatively low levels
- Only one pyrethroid pesticide was detected (bifenthrin at 8.9 ng/g); no other pesticides were detected

Table 4.23 CCCWP Water Year 2018 Sediment Chemistry Results

Analyte	Units ¹	Site 544R01737		
		Marsh Creek		
		Result	MDL	RL
<i>Metals</i>				
Arsenic	mg/Kg	3.9	0.31	1.0
Cadmium	mg/Kg	0.09	0.010	0.08
Chromium	mg/Kg	22	0.52	1.0
Copper	mg/Kg	18	0.077	0.41
Lead	mg/Kg	6.9	0.041	0.08
Nickel	mg/Kg	28	0.031	0.08
Zinc	mg/Kg	82	0.41	0.8
<i>Polycyclic Aromatic Hydrocarbons (PAHs)</i>				
Acenaphthene	ng/g	ND	3.1	5.2
Acenaphthylene	ng/g	ND	3.1	5.2
Anthracene	ng/g	ND	3.1	5.2
Benz(a)anthracene	ng/g	4.1	3.1	5.2
Benzo(a)pyrene	ng/g	ND	3.1	5.2
Benzo(b)fluoranthene	ng/g	5.2	3.1	5.2
Benzo(e)pyrene	ng/g	ND	3.1	5.2
Benzo(g,h,i)perylene	ng/g	ND	3.1	5.2
Benzo(k)fluoranthene	ng/g	ND	3.1	5.2
Biphenyl	ng/g	ND	3.4	5.2

Table 4.23 CCCWP Water Year 2018 Sediment Chemistry Results

Analyte	Units ¹	Site 544R01737		
		Marsh Creek		
		Result	MDL	RL
Chrysene	ng/g	8.3	3.1	5.2
Dibenz(a,h)anthracene	ng/g	ND	3.1	5.2
Dibenzothiophene	ng/g	ND	3.4	5.2
Dimethylnaphthalene, 2,6-	ng/g	ND	3.1	5.2
Fluoranthene	ng/g	8.3	3.1	5.2
Fluorene	ng/g	ND	3.1	5.2
Indeno(1,2,3-c,d)pyrene	ng/g	ND	3.1	5.2
Methylnaphthalene, 1-	ng/g	ND	3.1	5.2
Methylnaphthalene, 2-	ng/g	ND	3.1	5.2
Methylphenanthrene, 1-	ng/g	ND	3.1	5.2
Naphthalene	ng/g	3.1	3.1	5.2
Perylene	ng/g	ND	3.1	5.2
Phenanthrene	ng/g	8.3	3.1	5.2
Pyrene	ng/g	9.3	3.1	5.2
<i>Pyrethroid Pesticides</i>				
Bifenthrin	ng/g	8.9	0.52	1.3
Cyfluthrin, total	ng/g	ND	0.57	1.3
Cyhalothrin, Total lambda-	ng/g	ND	0.31	1.3
Cypermethrin, total	ng/g	ND	0.52	1.3
Deltamethrin/Tralomethrin	ng/g	ND	0.62	1.3
Esfenvalerate/Fenvalerate, total	ng/g	ND	0.67	1.3
Permethrin	ng/g	ND	0.57	1.3
<i>Other Pesticides</i>				
Carbaryl	ng/g	ND	0.021	0.031
Chlorpyrifos	ng/g	ND	0.62	1.3
Diazinon	ng/g	ND	0.46	1.3
Fipronil	ng/g	ND	0.52	1.3
Fipronil Desulfanyl	ng/g	ND	0.52	1.3
Fipronil Sulfide	ng/g	ND	0.52	1.3
Fipronil Sulfone	ng/g	ND	0.52	1.3
<i>Organic Carbon</i>				
Total Organic Carbon	%	1.8	0.1	0.1

¹ All measurements reported as dry weight

ND not detected

Table 4.24 Threshold Effect Concentration (TEC) and Probable Effect Concentration (PEC) Quotients for Water Year 2018 Sediment Chemistry Constituents

	Sample Units ¹	Site 544R01737		
		Marsh Creek		
		Sample	TEC Ratio	PEC Ratio
<i>Metals</i>				
Arsenic	mg/Kg	3.9	0.40	0.12
Cadmium	mg/Kg	0.09	0.09	0.02
Chromium	mg/Kg	22	0.51	0.20
Copper	mg/Kg	18	0.57	0.12
Lead	mg/Kg	6.9	0.19	0.05
Nickel	mg/Kg	28	1.23	0.58
Zinc	mg/Kg	82	0.68	0.18
<i>Polycyclic Aromatic Hydrocarbons (PAHs)</i>				
Anthracene	ng/g	ND		
Fluorene	ng/g	ND		
Naphthalene	ng/g	3.1	0.02	0.01
Phenanthrene	ng/g	8.3	0.04	0.01
Benz(a)anthracene	ng/g	4.1	0.04	0.00
Benzo(a)pyrene	ng/g	ND		
Chrysene	ng/g	8.3	0.05	0.01
Fluoranthene	ng/g	8.3	0.02	0.00
Pyrene	ng/g	9.3	0.05	0.01
Total PAHs ¹	ng/g	73	0.045	0.0032
Number with TEC > 1.0			1	
Combined TEC Ratio			3.93	
Average TEC Ratio			0.28	
Combined PEC Ratio				1.30
Average PEC Ratio				0.09

Note: All measurements reported as dry weight. TECs and PECs per MacDonald et al. (2000).

Bold TEC or PEC ratio indicates ratio 1.0

ND not detected

1 Total PAHs include 24 individual PAH compounds; NDs were substituted at 1/2 MDL to compute total PAHs

Sediment TU equivalents were calculated for the pyrethroid pesticides for which there are published LC₅₀ levels, and a sum of the calculated TU equivalents was computed for the dry season sediment chemistry results from the monitored site (Marsh Creek, site 544R01737) (Table 4.25). Because organic carbon mitigates the toxicity of pyrethroid pesticides in sediments, the LC₅₀ values are based on organic carbon-normalized pyrethroid concentrations. Therefore, the pyrethroid concentrations as reported by the lab were divided by the measured TOC concentration (as a percentage) at each site, and the TOC-normalized concentrations were then used to compute TU equivalents for each pyrethroid.

The most common urban pyrethroid pesticide, bifenthrin, was detected at the WY 2018 sediment monitoring site (see Table 4.23). The calculated TU equivalent of 0.95 (Table 4.25) is potentially sufficient to have caused the observed toxicity to *Hyalella azteca* in the sediment toxicity testing for this sample.

Table 4.25 Calculated Pyrethroid Toxic Unit Equivalents, Water Year 2018 Sediment Chemistry Data

Pyrethroid Pesticides	LC ₅₀ (µg/g organic carbon)	Site 544R01737		
		Marsh Creek		
		Sample (ng/g)	Sample (µg/g organic carbon)	TU Equivalents ¹
Bifenthrin	0.52	8.9	0.49	0.95
Cyfluthrin	1.08	ND		
Cyhalothrin, lambda	0.45	ND		
Cypermethrin	0.38	ND		
Deltamethrin/Tralomethrin	0.79	ND		
Esfenvalerate/Fenvalerate	1.54	ND		
Permethrin	10.8	ND		
Sum (Pyrethroid TUs)				0.95

Note: All sample measurements reported as dry weight.

ND not detected

1 Toxic unit equivalents (TU) are calculated as ratios of organic carbon-normalized pyrethroid sample concentrations to published *H. azteca* LC₅₀ values. See <http://www.tdcenvironmental.com/resources/Pyrethroids-Aquatic-Tox-Summary.pdf> for associated references.

4.3.7 Sediment Triad Analysis

Table 4.26 summarizes stressor evaluation results for sites with data collected for sediment chemistry, sediment toxicity, and bioassessment parameters by CCCWP over the first five years of the RMC regional/probabilistic monitoring effort (water years 2012-2018).

Pyrethroid pesticide sediment concentrations appear to be potent predictors of sediment toxicity, as samples with calculated pyrethroid TU equivalents greater than 1.0 exhibited significant sediment toxicity. The samples with TU equivalents less than 1.0 generally did not exhibit sediment toxicity, as shown in Table 4.26 (the 2018 sample being the exception, as the calculated TU equivalent was 0.95, and toxicity was observed to *Hyalella azteca* in the sediment sample).

Table 4.26 Summary of Sediment Quality Triad Evaluation Results, Water Years 2012-2018 Data

Water Year	Water Body	Site ID	B-IBI Condition Category	Sediment Toxicity	No. of TEC Quotients > 1.0	Mean PEC Quotient	Sum of TU Equivalents
2012	Grayson Creek	207R00011	Very Poor	Yes	10	0.14	2.17
2012	Dry Creek	544R00025	Very Poor	Yes	11	0.51	3.62
2013	Sycamore Creek	207R00271	Very Poor	Yes	0	0.04	10.5
2013	Marsh Creek	544R00281	Very Poor	Yes	4	0.13	1.03
2014	San Pablo Creek	206R00551	Very Poor	No	1	0.09	.016
2014	Grizzly Creek	207R00843	Very Poor	No	1	0.12	.11
2015	Rodeo Creek	206R01024	Poor	No	1	0.11	0.32
2015	Green Valley Creek	207R00891	Very Poor	Yes	3	0.12	1.11
2016	Rimer Creek	204R01519	Degraded (CSCI)	No	1	0.12	0.89
2017	West Branch Alamo Creek	204R01412	Degraded (CSCI) ¹	No	3	0.21	0.255
2018	Marsh Creek	544R01737		Yes	1	0.09	0.95

Note: Yellow-highlighted cells indicate results exceed permit trigger threshold.

¹ Based on WY 2016 bioassessment data

4.3.8 Analysis of Condition Indicators and Stressors

CSCI scores were calculated from the CCCWP bioassessment data beginning in WY 2016. The CSCI uses location-specific GIS data to compare the observed BMI taxonomic data to expected BMI assemblage characteristics from reference sites with similar geographical characteristics. All calculated CSCI scores for 2018 samples were again below the MRP 2.0 threshold of 0.795, indicating degraded benthic biological communities at the 10 sites monitored by CCCWP in WY 2018, per the MRP threshold. Additional work will need to be done with the CSCI scores in relation to this threshold to make a clearer assessment of relative biological conditions for these urban streams. The CSCI scores correlated well with the mini-PHab scores and the Contra Costa benthic-IBI scores for WY 2018 data.

The January 8 stormwater samples from both West Branch Alamo Creek (site 204R01412) and Marsh Creek (site 544R04613) were toxic to *Hyalella azteca*. The Marsh Creek sample *Hyalella azteca* result was less than 50 percent of the lab control, and therefore required retesting. Correspondingly, in the January 8 samples, per the TU calculations as indicated in Table 4.20, chemical analysis revealed toxic levels of bifenthrin, fipronil, and imidacloprid in both samples; in both cases, any of those pesticides could have theoretically caused toxicity alone. The Marsh Creek sample TUs were substantially higher than the West Branch Alamo Creek TUs for those constituents.

In the March 1 retest sample from the Marsh Creek site, the measured bifenthrin concentration produced a calculated CGU ≥ 1 (=1.8) for the acute criterion, and well above 1 (=14) for the chronic criterion. All other pyrethroids were non-detect in the March 1 sample. That sample also was highly toxic to *Hyalella azteca*, as indicated in Table 4.19. The bifenthrin TU equivalent (=3.3) calculated from the March 1 stormwater sample from Marsh Creek was sufficient to have caused the observed toxicity to *Hyalella azteca* in the March 1 sample. The sum of TU equivalents from fipronil + degradates for that site also hit 1.0, indicating possible toxicity from those constituents.

The Marsh Creek sediment sample was determined to be toxic to *Hyalella azteca*, but not to *Chironomus dilutus*. The sediment toxicity test results are shown in Table 4.22. The dry weather water sample was not toxic.

The principal stressors identified in the chemical analyses from the 2018 monitoring are pesticides, including bifenthrin, fipronil, and imidacloprid in water samples, and bifenthrin in sediments.

This page intentionally blank

5 Conclusions and Next Steps

During WY 2018, 10 sites were monitored by CCCWP under the RMC regional/probabilistic design for bioassessment, physical habitat, and water chemistry parameters. One site also was monitored for water and sediment toxicity and sediment chemistry. Based on the results of the bioassessment monitoring, all 10 sites monitored in WY 2018 produced CSCI scores below the MRP threshold, indicating sub-optimal biological conditions in the benthos of the monitored streams.

The water and sediment chemistry and toxicity data were used to evaluate potential stressors which may affect aquatic habitat quality and beneficial uses. The bioassessment and related data are also used to develop a preliminary condition assessment for the monitored sites, to be used in conjunction with the stressor assessment based on sediment chemistry and toxicity. The principal stressors affecting water and sediment quality – specifically causing toxicity – are pesticides.

5.1 Summary of Stressor Analyses

Based on an analysis of the regional/probabilistic data collected by CCCWP during WY 2018, the stressor analysis is summarized as follows:

Physical Habitat Conditions

IPI scores were calculated for the first time in 2018, from the PHab data compiled during the spring, 2018 bioassessment monitoring (Table 4.13). The resulting IPI scores produced two to three sites in each of the four IPI condition categories.

For the 2018 analysis, the benthic community indices (CSCI, CC B-IBI) correlated well with each other and with both of the PHab indices (Mini-PHab and IPI), and the two PHab indices correlated well with each other. The CC B-IBI also correlated well with the SoCal B-IBI. These results support the idea that there is a likely connection between stream physical habitat condition and benthic biological community health.

The two algal community indices (D18 and H20) were well correlated with each other, but neither of the algal indices correlated well with any other factor, indicating that algae community composition may be influenced principally by factors other than physical habitat, and that algae communities are somewhat independent of benthic taxonomic characteristics.

Water Quality

Of 12 water quality parameters required in association with bioassessment monitoring, applicable water quality standards were only identified for ammonia, chloride, and nitrate + nitrite (for sites with MUN beneficial use only). Four of the results generated at the 10 sites monitored for un-ionized ammonia during WY 2018 exceeded the applicable water quality standard.

Water Toxicity

The West Branch Alamo Creek (site 204R01412) and Marsh Creek (site 544R04613) stormwater samples from January 8 were both toxic to *Hyalella azteca*. The Marsh Creek sample *Hyalella azteca* result was less than 50 percent of the lab control, and therefore required retesting. The March 1 retest sample from the Marsh Creek site also was highly toxic to *Hyalella azteca*, as indicated in Table 4.19. Pesticide concentrations were determined in all cases to be more than sufficient to have caused the observed toxicity.

Sediment Toxicity

The Marsh Creek sediment sample was determined to be toxic to *Hyalella azteca*, but not to *Chironomus dilutus*. The pyrethroid pesticide bifenthrin was determined to be a probable cause of the observed sediment toxicity. The dry weather water sample was not toxic.

Sediment Chemistry

The pyrethroid pesticide bifenthrin was detected at quantifiable levels in the creek sediment sample, but the sum of pyrethroid pesticides did not exceed 1 TU. Another common current-use pesticide, fipronil, was not detected, but all three of the fipronil degradates were detected in the sediment sample.

Sediment Triad Analyses

Bioassessment, sediment toxicity, and sediment chemistry results were evaluated as the three lines of evidence used in the triad approach for assessing overall stream condition and added to the compiled results for water years 2012-2018. Good correlation is observed throughout that period in the triad analysis between pyrethroid concentrations with $TU \geq 1$ and sediment toxicity.

Chemical stressors, particularly pesticides, may be contributing to the degraded biological conditions indicated by the low B-IBI scores in many of the monitored streams.

5.2 Next Steps

The analysis presented in this report identifies several potentially impacted sites which may deserve further evaluation and/or investigation to provide better understanding of the sources/stressors which might contribute to reduced water quality and lower biological conditions.

Efforts are currently underway by the RMC to implement a new set of SSID projects for implementation during the current MRP term. CCCWP will continue to collaborate in this regional effort. Eight SSID projects are required regionally per MRP 2.0 if performed within a regional collaborative. CCCWP will perform one new SSID project during the MRP 2.0 permit term, and will participate in one regionally-coordinated project, per agreement within the RMC; this project may not involve toxicity. The current list of potential SSID projects is included as Appendix 3 to the CCCWP UCMR for WY 2018.

The RMC programs have undertaken a comprehensive, regional analysis of the first five years of bioassessment monitoring performed under the MRP as a BASMAA regional project. In addition to the regional data analysis, RMC programs will evaluate the existing Creek Status Monitoring Plan and probabilistic design and consider appropriate next steps to recommend for the monitoring design in the future.

Wet season toxicity and chemistry monitoring was completed by the RMC in WY 2018, as required by MRP 2.0 provision C.8.g.iii.

Candidate probabilistic sites previously classified with "unknown" sampling status in the RMC probabilistic site evaluation process may continue to be evaluated for potential sampling in WY 2019.

6 References

- ADH Environmental (ADH). 2019. Local/Targeted Creek Status Monitoring Report, Water Year 2018 (October 2016-September 2018).
- American Fisheries Society (AFS). Internet source.
http://fisheries.org/docs/pub_hatch/pub_ammonia_fwc.xls, Table 9: Ammonia Calculator (Freshwater) (computes the concentration of un-ionized ammonia as a function of temperature, pH, and salinity). <http://fisheries.org/hatchery>><http://fisheries.org/hatchery>.
- Barbour, M.T., J. Gerritsen, B.D. Snyder, and J.B. Stribling. 1999. *Rapid Bioassessment Protocols for Use in Streams and Wadeable Rivers: Periphyton, Benthic Macroinvertebrates and Fish*. Second Edition. EPA 841-B-99-002. U.S. Environmental Protection Agency; Office of Water; Washington, D.C.
- Bay Area Stormwater Management Agencies Association (BASMAA). 2011. *Regional Monitoring Coalition Final Creek Status and Long-Term Trends Monitoring Plan*. Prepared by EOA, Inc. Oakland, Calif. 23 pp.
- Bay Area Stormwater Management Agencies Association (BASMAA). 2013. *Regional Urban Creeks Status Monitoring Report, Water Year 2012 (October 1, 2011-September 30, 2012)*. Prepared for BASMAA by EOA, Inc. on behalf of the Santa Clara Urban Runoff Pollution Prevention Program and the San Mateo Countywide Water Pollution Prevention Program and Armand Ruby Consulting on behalf of the Contra Costa Clean Water Program.
- Bay Area Stormwater Management Agencies Association (BASMAA). 2016a. *Regional Monitoring Coalition Creek Status and Pesticides & Toxicity Monitoring Program Quality Assurance Project Plan*. Prepared By EOA, Inc., Applied Marine Sciences, and Armand Ruby Consulting. Version 3, March.
- Bay Area Stormwater Management Agencies Association (BASMAA). 2016b. *Regional Monitoring Coalition Creek Status and Pesticides & Toxicity Monitoring Standard Operating Procedures*. Prepared By EOA, Inc., Applied Marine Sciences, and Armand Ruby Consulting. Version 3, March.
- California Regional Water Quality Control Board, Central Valley Region (CVRWQCB). 2010. East Contra Costa County Municipal NPDES Permit. Waste Discharge Requirements Order R5-2010-0102; NPDES Permit No. CAS083313. 23 September 2010.
- California Regional Water Quality Control Board, Central Valley Region (CVRWQCB). 2017. Resolution R5-2017-0057, Amendment to the Water Quality Control Plan for the Sacramento River and San Joaquin River Basins for the Control of Pyrethroid Pesticide Discharges. Adopted June 8, 2017.
- Contra Costa Clean Water Program (CCCWP). 2007. Preliminary Assessment of Aquatic Life Use Condition in Contra Costa Creeks, Summary of Benthic Macroinvertebrate Bioassessment Results (2001-2006). Prepared by Eisenberg, Olivieri and Associates. Oakland, CA. 68 pp.
- Fetscher, A.E, L. Busse, and P.R. Ode. 2009. *Standard Operating Procedures for Collecting Stream Algae Samples and Associated Physical Habitat and Chemical Data for Ambient Bioassessments in California*. California State Water Resources Control Board Surface Water Ambient Monitoring Program (SWAMP) Bioassessment SOP 002. (Updated May 2010)

- Fetscher, A.E., M.A. Sutula, L.B. Busse, and E.D. Stein. 2013. *Condition of California Perennial, Wadeable Streams Based on Algal Indicators*. Final Technical Report 2007-11. October 2013.
See:
http://ftp.sccwrp.org/pub/download/DOCUMENTS/TechnicalReports/781_CA_Perennial_Wadeable_Streams.pdf
- Fetscher, A.E., R. Stancheva, J.P. Kociolek, R.G. Sheath, E.D. Stein, R.D. Mazor, P.R. Ode, L.B. Busse. 2014. Development and comparison of stream indices of biotic integrity using diatoms vs. non-diatom algae vs. a combination. *Journal of Applied Phycology* 26:433-450.
- Hill, B.H., A.T. Herlihy, P.R. Kaufmann, R.J. Stevenson, F.H. McCormick, and C.B. Johnson. 2000. Use of Periphyton Assemblage Data as an Index of Biotic Integrity. *Journal of the North American Benthological Society* 19(1): 50-67.
- Karr, J.R., and E.W. Chu. 1999. *Restoring Life in Running Waters: Better Biological Monitoring*. Island Press, Covelo, Calif.
- MacDonald, D.D., G.G. Ingersoll, and T.A. Berger. 2000. Development and Evaluation of Consensus-based Sediment Quality Guidelines for Freshwater Ecosystems. *Archives of Environmental Contamination and Toxicology* 39(1): 20-31.
- Mazor, Raphael, Peter R. Ode, Andrew C. Rehn, Mark Engeln, Tyler Boyle, Erik Fintel, Steve Verbrugge, Calvin Yang. 2016. The California Stream Condition Index (CSCI): Interim instructions for calculating scores using GIS and R. SCCWRP Technical Report #883. SWAMP-SOP-2015-0004. Revision Date: August 05, 2016
- Ode, P.R., A.C. Rehn, and J.T. May. 2005. A Quantitative Tool for Assessing the Integrity of Southern Coastal California Streams. *Environmental Management* 35(4): 493-504.
- Ode, P.R., T.M. Kincaid, T. Fleming, and A.C. Rehn. 2011. *Ecological Condition Assessments of California's Perennial Wadeable Streams: Highlights from the Surface Water Ambient Monitoring Program's Perennial Streams Assessment (PSA) (2000-2007)*. A Collaboration between the State Water Resources Control Board's Non-Point Source Pollution Control Program (NPS Program), Surface Water Ambient Monitoring Program (SWAMP), California Department of Fish and Game Aquatic Bioassessment Laboratory, and the U.S. Environmental Protection Agency.
- Ode, P.R., A.E., Fetscher, and L.B. Busse. 2016a. *Standard Operating Procedures for the Collection of Field Data for Bioassessments of California Wadeable Streams: Benthic Macroinvertebrates, Algae, and Physical Habitat*. California State Water Resources Control Board Surface Water Ambient Monitoring Program (SWAMP) Bioassessment SOP 004, SWAMP-SOP-SB-2016-0001.
- Ode, P.R., A.E., Fetscher, and L.B. Busse. 2016b. *Supplemental Guidance for the SWAMP Bioassessment Field Protocol*. California State Water Resources Control Board Surface Water Ambient Monitoring Program (SWAMP), SWAMP-SOP-SB-2016-0002.
- Rehn, A.C., R.D. Mazor and P.R. Ode. 2015. *The California Stream Condition Index (CSCI): A New Statewide Biological Scoring Tool for Assessing the Health of Freshwater Streams*. Swamp Technical Memorandum SWAMP-TM-2015-0002.
- Rehn, A.C. 2016. *Using Multiple Biological and Habitat Condition Indices for Bioassessment of California Streams*. SWAMP Technical Memorandum SWAMP-TM-SB-2016-0003.

- Rehn, A.C., R.D. Mazor and P.R. Ode. 2018a. An Index to Measure the Quality of Physical Habitat in California Wadeable Streams. Swamp Technical Memorandum SWAMP-TM-2018-0005.
- Rehn, A. C., R. D. Mazor. P. R. Ode, M. Beck, T. Boyle, E. Fintel, and C. Yang. 2018b. The Physical Habitat (PHAB) Index of Physical Integrity (IPI): Interim instructions for calculating scores using GIS and R. SWAMP-SOP-2018-0006.
- Ruby, Armand. 2012. *Contra Costa Monitoring and Assessment Program, Summary of Benthic Macroinvertebrate Bioassessment Results (2011)*. Prepared for Contra Costa Clean Water Program by Armand Ruby Consulting. July.
- San Francisco Bay Regional Water Quality Control Board (SFBRWQCB). 2009. Municipal Regional Stormwater NPDES Permit Order R2-2009-0074, NPDES Permit No. CAS612008, October 14, 2009. 279 pp.
- San Francisco Bay Regional Water Quality Control Board (SFBRWQCB). 2015. Municipal Regional Stormwater NPDES Permit Order No. R2-2015-0049, NPDES Permit No. CAS612008, November 19, 2015.
- San Francisco Bay Regional Water Quality Control Board (SFBRWQCB). 2017. Water Quality Control Plan for the San Francisco Bay Basin (Basin Plan). Updated through May 4, 2017.
- Santa Clara Valley Urban Runoff Pollution Prevention Program (SCVURPPP). 2007. *Monitoring and Assessment Summary Report, Santa Clara Basin Creeks (2002–2007)*. Prepared by Eisenberg, Olivieri, and Associates. 52 pp.
- Southern California Stormwater Monitoring Coalition (SMC). 2007. Regional Monitoring of Southern California's Coastal Watersheds. 32 pp.
- Stancheva, R., Busse, L., P. Kociolek, and R. Sheath. 2015. Standard Operating Procedures for Laboratory Processing and Identification of Stream Algae in California. California State Water Resources Control Board Surface Water Ambient Monitoring Program (SWAMP) Bioassessment SOP 0003.
- Stevens, D.L., Jr., and A.R. Olsen. 2004. Spatially Balanced Sampling of Natural Resources. *Journal of the American Statistical Association* 99(465): 262-278.

This page intentionally blank

Appendix 2

Local/Targeted Creek Status Monitoring Report:

Water Year 2018

This page intentionally blank

Contra Costa Clean Water Program

Local/Targeted Creek Status Monitoring Report: Water Year 2018 (October 2017 – September 2018)

March 27, 2019

Submitted to



Contra Costa Clean Water Program
255 Glacier Drive
Martinez, California 94553

Submitted by



ADH Environmental
3065 Porter Street, Suite 101
Soquel, California 95073

This page intentionally blank

Contra Costa Clean Water Program

Local/Targeted Creek Status Monitoring Report: Water Year 2018 (October 2017 – September 2018)

March 27, 2019

Submitted to

Contra Costa Clean Water Program
255 Glacier Drive
Martinez, California 94553

Submitted by

ADH Environmental
3065 Porter Street, Suite 101
Soquel, California 95073

This page intentionally blank

Table of Contents

List of Acronyms and Abbreviations v

Prefacevii

Executive Summaryix

1 Introduction 1

2 Study Area and Design..... 1

 2.1 Regional Monitoring Coalition Area 1

 2.2 Contra Costa County Targeted Monitoring Areas and Siting Rationale 1

 2.2.1 Walnut Creek Watershed – Las Trampas Creek Sub-watershed 1

 2.2.2 Alhambra Creek Watershed 3

 2.2.3 San Pablo Creek Watershed 4

 2.2.4 Pinole Creek Watershed..... 4

 2.3 Contra Costa Targeted Monitoring Design 5

3 Monitoring Methods 9

 3.1 Data Collection Methods 9

 3.1.1 Continuous Water Quality Measurements..... 9

 3.1.2 Continuous Temperature Monitoring 9

 3.1.3 Pathogen Indicator Sampling 10

 3.2 Quality Assurance/Quality Control 10

 3.3 Data Quality Assessment Procedures 10

 3.4 Data Analysis and Interpretation 11

 3.4.1 Dissolved Oxygen (DO)..... 12

 3.4.2 Hydrogen Ion Concentration (pH) 13

 3.4.3 Pathogen Indicator Bacteria 13

 3.4.4 Temperature 14

4 Results 19

 4.1 Statement of Data Quality 19

 4.2 Water Quality Monitoring Results 19

 4.2.1 Water Temperature (Continuous/HOBO) 19

 4.2.2 Continuous Water Quality..... 24

 4.2.3 Water Quality Data Evaluation for Steelhead Suitability 31

 4.3 Pathogen Indicator Bacteria 34

5 Next Steps 37

6 References 39

List of Figures

Figure 2.1	Map of BASMAA RMC Area, County Boundaries and Major Creeks	2
Figure 2.2	Overview of Targeted Sites Monitored by CCCWP in Water Year 2018	7
Figure 4.1	Water Temperature Data Collected at Four Sites in Contra Costa County (Alhambra Creek, San Pablo Creek, and Pinole Creek), April 19-September 30, 2018	21
Figure 4.2	Weekly Average Water Temperature Data Collected at Four Sites (Alhambra Creek, San Pablo Creek, and Pinole Creek), April 19-September 30, 2018.....	22
Figure 4.3	Box Plots of Weekly Average Temperature Data Collected at Four Sites in Contra Costa County (Alhambra Creek, San Pablo Creek, and Pinole Creek), April 19-September 30, 2018	23
Figure 4.4	Continuous Water Quality Data (Temperature) Measured in Contra Costa County (Las Trampas Creek and San Pablo Creek), May 8-17 and September 4-14, 2018	26
Figure 4.5	Continuous Water Quality Data (pH) Measured in Las Trampas Creek and San Pablo Creek, May 8-17 and September 4-14, 2018	27
Figure 4.6	Continuous Water Quality Data (Dissolved Oxygen) Measured in Las Trampas Creek and San Pablo Creek, May 8-17 and September 4-14, 2018	28
Figure 4.7	Continuous Water Quality Data (Specific Conductivity) Measured in Las Trampas Creek and San Pablo Creek, May 8-17 and September 4-14, 2018	29

List of Tables

Table ES.1.	Designated Beneficial Uses Listed in the San Francisco Bay Region Basin Plan (SFRWQCB, 2015) for CCCWP Targeted Monitoring Sites in Water Year 2018	xi
Table ES.2	CCCWP Threshold Exceedances for Water Year 2018	xii
Table 1.1	Regional Monitoring Coalition Participants.....	2
Table 1.2	Creek Status Monitoring Parameters Sampled in Compliance with MRP Provisions C.8.d. and C.8.g. as Either Regional/Probabilistic or Local/Targeted Parameters	2
Table 2.1	Targeted Sites and Local Reporting Parameters Monitored in Water Year 2018 in Contra Costa County	6
Table 3.1	Data Quality Steps Implemented for Temperature and Continuous Water Quality Monitoring	11
Table 3.2	Requirements for Follow-Up for Local/Targeted Creek Status Monitoring Results Per MRP Provision C.8.d	12
Table 3.3	USEPA 2012 Recreational Water Quality Criteria.....	13
Table 4.1	Accuracy ¹ Measurements Taken for Dissolved Oxygen, pH and Specific Conductivity	19
Table 4.2	Descriptive Statistics for Continuous Water Temperature Measured at Four Sites in Contra Costa County (Alhambra Creek, San Pablo Creek, and Pinole Creek), April 19-September 30, 2018	20
Table 4.3	Water Temperature Data Measured at Four Sites in Comparison to MRP WAT Trigger Threshold for Steelhead Streams.....	24
Table 4.4	Descriptive Statistics for Daily and Monthly Continuous Water Quality Parameters (Temperature, Dissolved Oxygen, Conductivity and pH) Measured in Contra Costa County (Las Trampas Creek and San Pablo Creek), May 8-17 and September 4-14, 2018 ..	25
Table 4.5	Maximum Weekly Average Temperatures Measured at Two Sites (Las Trampas Creek and San Pablo Creek) for Both Events	25
Table 4.6	Percent of Dissolved Oxygen and pH Data Measured at Two Sites (Las Trampas and San Pablo Creek) for Both Events Exceeding Water Quality Evaluation Criteria Identified in Table 3.3	30

Table 4.7 Enterococci and *E. coli* Levels Measured from Water Samples Collected at Five Locations in Creeks in Contra Costa County (June 28, 2018) 35

Table 5.1 Summary of CCCWP Threshold Exceedances for Water Year 2018 37

This page intentionally blank

List of Acronyms and Abbreviations

ACCWP	Alameda Countywide Clean Water Program
ADH	ADH Environmental
ARC	Armand Ruby Consulting
BASMAA	Bay Area Stormwater Management Agencies Association
CCCWP	Contra Costa Clean Water Program
CFU	colony forming units
COLD	cold freshwater habitat
CVRWQCB	Central Valley Regional Water Quality Control Board
DO	dissolved oxygen
EBMUD	East Bay Municipal Utility District
FSURMP	Fairfield-Suisun Urban Runoff Management Program
GM	geometric mean
MPN	most probable number
MRP	municipal regional permit
MWAT	maximum weekly average temperature
NPDES	National Pollutant Discharge Elimination System
pH	hydrogen ion concentration
QAPP	quality assurance project plan
Region 2	San Francisco Regional Water Quality Control Board
Region 5	Central Valley Regional Water Quality Control Board
RMC	Regional Monitoring Coalition
SCVURPPP	Santa Clara Valley Urban Runoff Pollution Prevention Program
SFRWQCB	San Francisco Bay Regional Water Quality Control Board
SMCWPPP	San Mateo Countywide Water Pollution Prevention Program
SOP	standard operating procedure
SSID	stressor/source identification
STV	statistical threshold value
SWAMP	Surface Water Ambient Monitoring Program
USEPA	U.S. Environmental Protection Agency
WARM	warm water habitat
WAT	weekly average temperature
WQOs	water quality objectives
WY	water year
YSI	Yellow Springs Instrument Company

This page intentionally blank

Preface

Contra Costa County lies within both the Region 2 and Region 5 jurisdictions of the State Water Resources Control Board. The countywide stormwater program is subject to both the Region 2 municipal regional stormwater National Pollutant Discharge Elimination System (NPDES) permit (MRP)¹ and the equivalent Region 5 permit (Central Valley Permit)².

This local/targeted creek status monitoring report documents the results of targeted (non-probabilistic) monitoring performed by the Contra Costa Clean Water Program (CCCWP) in water year 2018 (October 1, 2017-September 30, 2018). Together with the creek status monitoring data reported in *Regional/Probabilistic Creek Status Monitoring Report: Water Year 2018* (ARC, 2019), this submittal fulfills monitoring requirements specified in provision C.8.d of the permit, complies with reporting provision C.8.h of the MRP (SFRWQCB, 2015), and fulfills the monitoring requirements highlighted in Table 8.1 and the reporting requirements of provision C.8.g of the Central Valley Permit.

In early 2010, several members of the Bay Area Stormwater Management Agencies Association (BASMAA) joined together to form the Regional Monitoring Coalition (RMC) to coordinate and oversee water quality monitoring required by the MRP. The RMC includes the following stormwater program participants:

- Alameda Countywide Clean Water Program
- Contra Costa Clean Water Program
- San Mateo Countywide Water Pollution Prevention Program
- Santa Clara Valley Urban Runoff Pollution Prevention Program
- Fairfield-Suisun Urban Runoff Management Program
- City of Vallejo and Vallejo Sanitation and Flood Control District

In accordance with the RMC *Creek Status and Long-Term Trends Monitoring Plan* (EOA and ARC, 2011), targeted monitoring data were collected following methods and protocols specified in the BASMAA RMC *Quality Assurance Project Plan* (QAPP; BASMAA, 2014a) and BASMAA RMC *Standard Operating Procedures* (BASMAA, 2014b). Where applicable, monitoring data were derived using methods comparable with methods specified by the California Surface Water Ambient Monitoring Program (SWAMP) QAPP³. Data presented in this report were also submitted to the San Francisco Estuary Institute for submittal to the State Water Resources Control Board on behalf of CCCWP's permittees and pursuant to permit provision C.8.h. requirements for electronic data reporting.

¹ The San Francisco Bay Regional Water Quality Control Board (SFRWQCB) issued the MRP to 76 cities, counties and flood control districts (i.e., the permittees) in the Bay Area on October 14, 2009 (SFRWQCB, 2009). On November 19, 2015, SFRWQCB issued Order No. R2-2015-0049. This amendment supersedes and rescinds Order Nos. R2-2009-0074 and R2-2011-0083, and became effective January 1, 2016. The BASMAA programs supporting MRP regional projects include all MRP permittees, as well as the cities of Antioch, Brentwood and Oakley, which are not named as permittees under the MRP, but have voluntarily elected to participate in MRP-related regional activities.

² The Central Valley Regional Water Quality Control Board (CVRWQCB) issued the East Contra Costa County Municipal NPDES Permit (Central Valley Permit, Order No. R5-2010-0102) on September 23, 2010 (CVRWQB, 2010).

³ The current SWAMP QAPP is available at:
http://www.waterboards.ca.gov/water_issues/programs/swamp/docs/qapp/swamp_qapp_master090108a.pdf

This page intentionally blank

Executive Summary

This local/targeted creek status monitoring report documents the results of targeted monitoring performed by Contra Costa Clean Water Program (CCCWP) during water year 2018. Together with the creek status monitoring data reported in *Regional/ Probabilistic Creek Status Monitoring Report: Water Year 2018* (ARC, 2019), this submittal fulfills reporting requirements for status monitoring specified under provision C.8.d of the municipal regional permit (MRP) for urban stormwater issued by the San Francisco Bay Regional Water Quality Control Board (SFRWQCB; Order No. R2-2015-0049) and for monitoring specified in Table 8.1 under provision C.8.c of the East Contra Costa County municipal National Pollutant Discharge Elimination System (NPDES) permit (Central Valley Permit) issued by the Central Valley Regional Water Quality Control Board (CVRWQCB; Order No. R5-2010-0102). Reporting requirements for constituents under SFRWQCB are established in provision C.8.d and reporting requirements for CVRWQCB are established in provision C.8.g.iii. Both permits follow provisions promoting a coordinated countywide program of water quality management.

Within Contra Costa County, targeted monitoring was conducted at:

- Four continuous water temperature monitoring locations
- Two continuous general water quality monitoring locations
- Five pathogen indicator monitoring locations

Continuous Water Temperature

Hourly water temperature measurements were recorded at 60-minute intervals using Onset® HOBO® data loggers (HOBOS) deployed in three creeks at four separate locations on April 19, 2018. One device each was deployed in San Pablo Creek and Pinole Creek, and two devices were deployed in Alhambra Creek. The HOBOS were retrieved on October 3, 2018. As the permit term reporting requirements apply only to the extent of a given water year, all data collected after September 30, 2018 are not included in this report.

Pathogen Indicators

Samples were collected on June 28, 2018 at five stations along five separate creeks in Contra Costa County. Samples were analyzed for enterococci and *E. coli*. The five sampling locations were located at Wildcat Creek, Pinole Creek, Sans Crainte Creek, San Pablo Creek, and Grayson Creek.

General (Continuous) Water Quality

Temperature, dissolved oxygen (DO), hydrogen ion concentration (pH), and specific conductance were continuously monitored at 15-minute intervals by sondes during two time periods (May 8-17, 2018 and September 4-14, 2018) at two locations along Las Trampas Creek (207WAL411 and 207R02891) and one location at San Pablo Creek (206SPA125). At Las Trampas Creek, station 207WAL411 was continuously monitored during the spring deployment, while station 207R02891 was continuously monitored during the summer deployment.

Results of Targeted Monitoring Data

All targeted monitoring data were evaluated against numeric trigger thresholds, as described in MRP provision C.8.d. These thresholds, which include applicable numeric water quality objectives or other

applicable criteria, indicate levels at which additional follow-up may be required under the MRP. Targeted monitoring locations for water year 2018 were located entirely within SFRWQCB Region 2 boundaries. Therefore, numeric thresholds are discussed in this report only as they are stated in MRP provision C.8.d. The results are summarized below.

Temperature – HOBO and Sonde

The trigger threshold for temperature is defined in the MRP for all streams as 20 percent or more of instantaneous results exceeding 24° C. For streams documented to support steelhead fisheries (i.e., steelhead streams), a maximum weekly average temperature (MWAT) of 17° C is used as the applicable criterion to evaluate temperature data. Per the MRP, for the HOBO temperature data, a maximum of one weekly average temperature (WAT) can exceed the threshold of 17° C during the deployment period. For temperature data recorded by sonde devices, which are deployed for a much briefer period (1 to 2 weeks), all WATs must be below 17° C.

For the purpose of this report, creeks with designated beneficial uses listed in Table ES.1 as cold freshwater habitat (COLD) are evaluated as steelhead streams, while creeks designated only as warm freshwater habitat (WARM) are referred to as non-steelhead streams.

For water year 2018, per permit guidelines, only streams designated as COLD freshwater habitat were targeted for temperature monitoring.

At the four locations with continuously recorded HOBO temperature data from April until September, all three creeks (Alhambra Creek, Pinole Creek and San Pablo Creek) are classified as steelhead streams.

Temperature was continuously monitored by sondes during two time periods (May 8-17, 2018 and September 4-14, 2018) at Las Trampas Creek and San Pablo Creek, which are both classified as steelhead streams.

No water year 2018 temperature monitoring location recorded more than 20 percent instantaneous results above 24° C; therefore, there were no exceedances of this criterion.

However, there were exceedances of the 17° C WAT threshold in four of eight cases. These locations were Pinole Creek and both locations along Alhambra Creek for the HOBO data, and Las Trampas Creek for the sonde data during the September deployment. No exceedance occurred for the HOBO data or sonde data during the San Pablo Creek deployment period.

Table ES.1. Designated Beneficial Uses Listed in the San Francisco Bay Region Basin Plan (SFRWQCB, 2015) for CCCWP Targeted Monitoring Sites in Water Year 2018

Site ID	Water Body	Human Consumptive Uses							Aquatic Life Uses							Recreational Uses				
		AGR	MUN	FRSH	GWR	IND	PROC	COMM	SHELL	COLD	EST	MAR	MIGR	RARE	SPWN	WARM	WILD	REC-1	REC-2	NAV
207ALH015	Alhambra Creek									E			E	E		E	E	E	E	
207ALH110	Alhambra Creek									E						E	E	E	E	
206SPA125	San Pablo Creek			E						E			E	E	E	E	E	E	E	
206R01495	Pinole Creek									E			E	E	E	E	E	E	E	

E Existing beneficial use

Notes:

Per Basin Plan Ch. 2 (SFRWQCB, 2015), beneficial uses for freshwater creeks include municipal and domestic supply (MUN), agricultural supply (AGR), industrial process supply (PRO), groundwater recharge (GWR), water contact recreation (REC1), noncontact water recreation (REC2), wildlife habitat (WILD), cold freshwater habitat (COLD), warm freshwater habitat (WARM), fish migration (MIGR), and fish spawning (SPWN). The San Francisco Bay Estuary supports estuarine habitat (EST), industrial service supply (IND), and navigation (NAV) in addition to all uses supported by streams. Beneficial uses for coastal waters include water contact recreation (REC1); noncontact water recreation (REC2); industrial service supply (IND); navigation (NAV); marine habitat (MAR); shellfish harvesting (SHELL); ocean, commercial and sport fishing (COMM); and preservation of rare and endangered species (RARE).

Dissolved Oxygen (DO)

The MRP trigger threshold for dissolved oxygen in non-tidal waters is applied as follows: for waters designated as steelhead streams, no more than 20 percent of instantaneous dissolved oxygen results may drop below 7.0 mg/L.

During the May monitoring period, the 20 percent threshold was not exceeded (for DO results of less than 7.0 mg/L) for dissolved oxygen measurements at Las Trampas Creek and San Pablo Creek. During the September deployment at Las Trampas Creek and San Pablo Creek, 47 percent and 100 percent of dissolved oxygen concentrations, respectively, were measured below the 7.0 mg/L threshold.

pH

The MRP trigger threshold for pH in surface waters is applied as follows: no more than 20 percent of instantaneous pH results may fall outside the range of 6.5 to 8.5. This range was used to evaluate the pH data collected at all targeted locations over water year 2018.

During both monitoring periods, pH measurements at Las Trampas Creek and San Pablo Creek did not exceed the 20 percent threshold for pH results outside of the acceptable range.

Specific Conductance

The MRP trigger threshold for specific conductance in surface waters is applied as follows: no more than 20 percent of instantaneous specific conductance results may exceed 2,000 µS/cm, and readings should not indicate a spike in specific conductance with no obvious natural explanation.

During both monitoring periods, specific conductance measurements at Las Trampas Creek and San Pablo Creek did not exceed the 20 percent threshold for specific conductance results above 2,000 µS/cm.

Pathogen Indicator Bacteria

The single sample maximum concentrations of 130 CFU/100 ml for enterococci and 410 CFU/100 ml for *E. coli* were used as water contact recreation evaluation thresholds for the purposes of this evaluation, based on an adaptation of the recommended water quality criteria established by U.S. Environmental Protection Agency (USEPA) to protect recreational uses (USEPA, 2012).

For enterococci, two out of five single sample concentrations (Sans Crainte Creek and Wildcat Creek) exceeded the single sample threshold concentration. For *E. coli*, two of the five stations (Sans Crainte Creek and Grayson Creek) exceeded the threshold concentration for water contact recreation criteria.

Exceedances for each of the above parameters are summarized below in Table ES.2.

Table ES.2 CCCWP Threshold Exceedances for Water Year 2018

Creek	Index Period	Parameter	Threshold Exceedance
Alhambra Creek (at Martinez Junior High School)	May 31-September 12, 2018	Continuous Water Temperature (HOBO)	More than two WATs exceed 17° C
Alhambra Creek (at D Street Drop Structure)	June 14-September 12, 2018	Continuous Water Temperature (HOBO)	More than two WATs exceed 17° C
Pinole Creek	June 7-13, 2018; June 21-August 15, 2018	Continuous Water Temperature (HOBO)	More than two WATs exceed 17° C
Las Trampas Creek at Olympic Blvd. Staging Area	September 4-14, 2018	Continuous Water Temperature (sonde)	One WAT exceeds 17° C
Las Trampas Creek	September 4-14, 2018	Continuous Water Quality - DO	20 percent of instantaneous results below 7.0 mg/L
San Pablo Creek	September 4-14, 2018	Continuous Water Quality - DO	20 percent of instantaneous results below 7.0 mg/L
Sans Crainte Creek	June 28, 2018	Enterococci	Single grab sample exceeded USEPA criterion of 130 CFU/100 ml
Wildcat Creek	June 28, 2018	Enterococci	Single grab sample exceeded USEPA criterion of 130 CFU/100 ml
Sans Crainte Creek	June 28, 2018	<i>E. coli</i>	Single grab sample exceeded USEPA criterion of 410 CFU/100 ml
Grayson Creek	June 28, 2018	<i>E. coli</i>	Single grab sample exceeded USEPA criterion of 410 CFU/100 ml

WAT weekly average temperature

DO dissolved oxygen

CFU colony forming unit

1 Introduction

Contra Costa County lies within the jurisdictions of both the San Francisco Bay Regional Water Quality Control Board (Region 2) and the Central Valley Regional Water Quality Control Board (Region 5). Municipal stormwater discharges in Contra Costa County are regulated by the requirements of both the municipal regional permit (MRP) for urban stormwater in Region 2 (Order No. R2-2015-0049), and the East Contra Costa County municipal National Pollutant Discharge Elimination System (NPDES) permit (Central Valley Permit) in Region 5 (Order No. R5-2010-0102)^{4,5}. This Local/Targeted Creek Status Monitoring Report documents the results of targeted (non-probabilistic) monitoring performed by Contra Costa Clean Water Program (CCCWP) during water year (WY) 2018 (October 1, 2017-September 30, 2018), and complies with reporting provision C.8.h of the Region 2 municipal NPDES permit, and provision C.8.g of the Region 5 municipal NPDES permit for creek status monitoring data collected during WY 2018. Together with the creek status monitoring data reported in *Regional/Probabilistic Creek Status Monitoring Report: Water Year 2018* (ARC, 2019), this submittal fulfills monitoring requirements in permit provision C.8.d of the MRP and for Table 8.1 monitoring specified in provision C.8.c of the Central Valley Permit.

Members of the Bay Area Stormwater Management Agencies Association (BASMAA) formed the Regional Monitoring Coalition (RMC) in early 2010 to collaboratively implement the monitoring requirements found in provision C.8 of the MRP (Table 1.1). The BASMAA RMC developed a quality assurance project plan (QAPP) (BASMAA, 2014a), standard operating procedures (SOPs) (BASMAA, 2014b), data management tools, and reporting templates and guidelines. Costs for these activities are shared among RMC members on a population-weighted basis by direct contributions and provision of in-kind services by RMC members to complete required tasks. Participation in the RMC is facilitated through the BASMAA Monitoring and Pollutants of Concern Committee.

The goals of the RMC are to:

1. Assist RMC permittees in complying with requirements of MRP provision C.8 (water quality monitoring)
2. Develop and implement regionally consistent creek monitoring approaches and designs in the Bay Area through improved coordination among RMC participants and other agencies (e.g., regional water quality control boards, Regions 2 and 5, and the State Water Resources Control Water Board), which share common goals
3. Stabilize the costs of creek monitoring by reducing duplication of efforts and streamlining reporting

The RMC divided the creek status monitoring requirements specified by permit provisions into those parameters which could reasonably be included within a regional/probabilistic design, and those which, for logistical and jurisdictional reasons, should be implemented locally using a targeted (non-probabilistic) design. The monitoring elements included in each category are specified in Table 1.2.

⁴ The SFRWQCB issued the five-year municipal regional permit for urban stormwater (MRP, Order No. R2-2015-0049) to 76 cities, counties and flood control districts (i.e., permittees) in the Bay Area on November 19, 2015 (SFRWQCB, 2015a). The BASMAA programs supporting MRP regional projects include all MRP permittees, as well as the cities of Antioch, Brentwood, and Oakley, which are not named as permittees under the MRP but have voluntarily elected to participate in MRP-related regional activities.

⁵ The CVRWQCB issued the East Contra Costa County municipal NPDES permit (Central Valley Permit, Order No. R5-2010-0102) on September 23, 2010 (CVRWQB, 2010).

Table 1.1 Regional Monitoring Coalition Participants

Stormwater Programs	RMC Participants
Santa Clara Valley Urban Runoff Pollution Prevention Program (SCVURPPP)	Cities of Campbell, Cupertino, Los Altos, Milpitas, Monte Sereno, Mountain View, Palo Alto, San Jose, Santa Clara, Saratoga, Sunnyvale, Los Altos Hills, and Los Gatos; Santa Clara Valley Water District; and Santa Clara County
Alameda Countywide Clean Water Program (ACCWP)	Cities of Alameda, Albany, Berkeley, Dublin, Emeryville, Fremont, Hayward, Livermore, Newark, Oakland, Piedmont, Pleasanton, San Leandro, and Union City; Alameda County; Alameda County Flood Control and Water Conservation District; and Zone 7
Contra Costa Clean Water Program (CCCWP)	City of Antioch, City of Brentwood, City of Clayton, City of Concord, Town of Danville, City of El Cerrito, City of Hercules, City of Lafayette, City of Martinez, Town of Moraga, City of Oakley, City of Orinda, City of Pinole, City of Pittsburg, City of Pleasant Hill, City of Richmond, City of San Pablo, City of San Ramon, City of Walnut Creek, Contra Costa County Flood Control and Water Conservation District and Contra Costa County Watershed Program
San Mateo County Wide Water Pollution Prevention Program (SMCWPPP)	Cities of Belmont, Brisbane, Burlingame, Daly City, East Palo Alto, Foster City, Half Moon Bay, Menlo Park, Millbrae, Pacifica, Redwood City, San Bruno, San Carlos, San Mateo, South San Francisco, Atherton, Colma, Hillsborough, Portola Valley, and Woodside; San Mateo County Flood Control District; and, San Mateo County
Fairfield-Suisun Urban Runoff Management Program (FSURMP)	Cities of Fairfield and Suisun City
Vallejo Permittees	City of Vallejo and Vallejo Sanitation and Flood Control District

Table 1.2 Creek Status Monitoring Parameters Sampled in Compliance with MRP Provisions C.8.d. and C.8.g. as Either Regional/Probabilistic or Local/Targeted Parameters

Biological Response and Stressor Indicators	Monitoring Design	
	Regional Ambient (Probabilistic)	Local (Targeted)
Bioassessment, physical habitat assessment, CSCI	X	
Nutrients (and other water chemistry associated with bioassessment)	X	
Chlorine		X
Water toxicity (wet and dry weather)	NA	
Water chemistry (pesticides, wet weather)	NA	
Sediment toxicity	NA	
Sediment chemistry	NA	
Continuous water quality (sonde data: temperature, dissolved oxygen, pH, specific conductance)		X
Temperature (HOBO data loggers)		X
Bacteria		X

NA Monitoring parameter not applicable to either monitoring design

This report focuses on the creek status and long-term trends monitoring activities conducted to comply with provision C.8.d using a targeted (non-probabilistic) monitoring design (see Table 1.2).

As a professional fisheries biologist familiar with Contra Costa County streams, Scott Cressey reviewed the tabulated and graphed water quality monitoring data from WY 2018 and compared these data to the San Francisco Bay Basin Plan (SFRWQCB, 2015b) beneficial use designations for these streams and the Basin Plan water quality objectives (WQOs), especially those associated with COLD objectives. His

assessment of these data was provided to ADH in a memorandum (Cressey, 2018). Relevant information from this assessment is incorporated into the narrative in the following sections.

The remainder of this report describes the study area and design (Section 2), monitoring methods (Section 3), results and discussion (Section 4), and next steps (Section 5).

This page intentionally blank

2 Study Area and Design

2.1 Regional Monitoring Coalition Area

The RMC area encompasses 3,407 square miles of land in the San Francisco Bay Area. This includes the portions of the five participating counties which fall within the jurisdiction of the SFRWQCB (Figure 2.1). Figure 2.1 illustrates the boundaries of the State Water Resources Control Board, Regions 2 and 5, as well as the Contra Costa County delta boundaries⁶. The eastern portion of Contra Costa County drains to the CVRWQCB region (Region 5), while the rest of the county drains into Region 2. Status and trends monitoring is conducted in flowing water bodies (i.e., creeks, streams and rivers) interspersed among the RMC area, including perennial and non-perennial creeks and rivers running through both urban and non-urban areas.

2.2 Contra Costa County Targeted Monitoring Areas and Siting Rationale

Contra Costa County has 31 major watersheds and sub-watersheds containing more than 1,300 miles of creeks and drainages (CCCDD, 2003). The County's creeks discharge into the Sacramento-San Joaquin Delta in the east, along the series of bays to the north (including Suisun and San Pablo bays), and to North San Francisco Bay in the west. In addition, two watersheds (Upper San Leandro and Upper Alameda Creek) originate in Contra Costa County and continue through Alameda County before reaching San Francisco Bay.

Four of the county's watersheds were the focus of targeted monitoring and sampling in WY 2018. The Walnut Creek, Alhambra Creek, San Pablo Creek, and Pinole Creek watersheds were sampled for pathogen indicators or selected for monitoring of continuous water temperature and continuous water quality parameters. Further details and discussion about the targeted sampling areas can be found in the Monitoring Methods and Results sections of this report (Sections 3 and 4, respectively).

All targeted sampling in WY 2018 was conducted in Region 2.

2.2.1 Walnut Creek Watershed – Las Trampas Creek Sub-watershed

The Walnut Creek watershed is in central Contra Costa County, with boundaries demarcated by the west side of Mount Diablo and the east side of the East Bay Hills. At 93,556 acres, it is the largest watershed in the county. The watershed has eight major tributaries which flow into the generally south-north trending direction of Walnut Creek. These tributaries include San Ramon Creek, Bollinger Creek, Las Trampas Creek, Lafayette Creek, Grayson Creek, Murderers Creek, Pine Creek, and Galindo Creek.

Due to steep slopes and land protection efforts, the upper watersheds along the perimeter of the Walnut Creek watershed generally remain undeveloped open space. The valleys of the watershed are densely urbanized and populated by the cities of Walnut Creek, Lafayette, Pleasant Hill and Danville. The cities of Concord and Martinez, as well as small areas of Moraga and San Ramon, also are partly within the watershed (Walking, 2013).

⁶Divide between the basin boundary watershed/hydrologic sub basins within the Sacramento-San Joaquin Rivers and Delta Waterways.

Figure 2.1 Map of BASMAA RMC Area, County Boundaries and Major Creeks

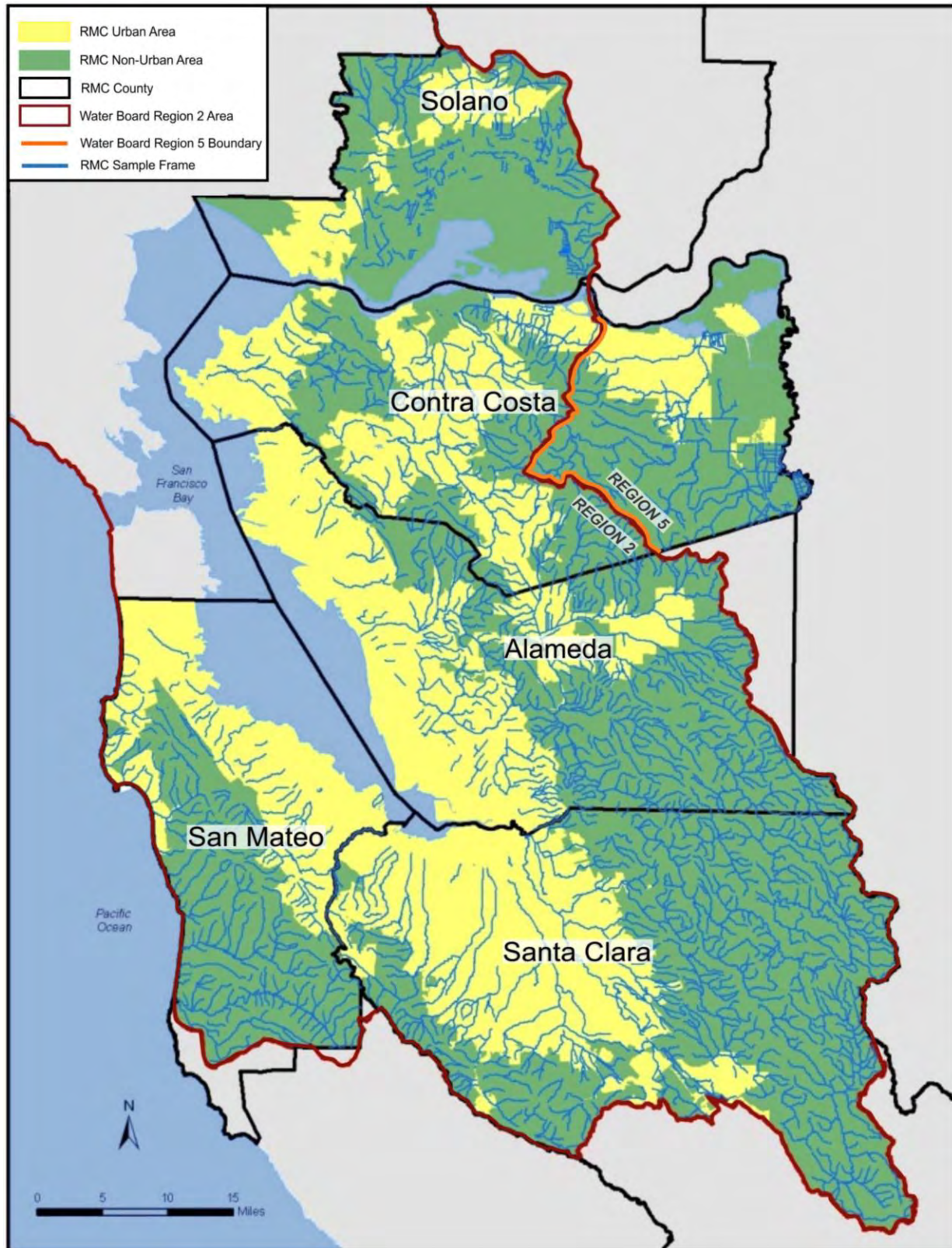

Walnut Creek has the second longest running stream length in the county at 28.74 miles. Its highest elevation lies at 3,849 feet, while the mouth joins sea level at Suisun Bay. An estimated 71.5 percent of its stream channel remains in a natural state, with the remaining portion containing man-made reinforcements. Estimated impervious surfaces make up 30 percent of its watershed. Walnut Creek's estimated mean daily flow is 81.4 cubic feet per second (CCCDD, 2003).

Historically, Las Trampas Creek likely supported a population of steelhead, as steelhead migrated up the Walnut Creek/San Ramon Creek drainage system into which Las Trampas Creek flows. Leidy et al. (2005) state that steelhead are no longer in Las Trampas Creek and its tributaries, as drop structures on Walnut Creek immediately below the City of Walnut Creek have prevented steelhead and chinook salmon migration into the watershed for many years. Lafayette Creek, a tributary of Las Trampas Creek, is reported to support rainbow trout (Cressey, 2016); however, those fish are believed to come from Lafayette Reservoir and transported into the creek by storm flows and spill events (ADH, 2017). Sustainable numbers of rainbow trout are still believed to be present in Lafayette Creek, suggesting Las Trampas Creek likely could support a viable population of resident rainbow trout in its upper watershed (ADH, 2018).

One location in the Walnut Creek watershed, located along Las Trampas Creek, was selected for targeted monitoring in WY 2018. Las Trampas Creek is a sub-watershed to Walnut Creek, with a 12.37-mile branch which eventually joins with San Ramon Creek to form Walnut Creek on the south side of the City of Walnut Creek. The 17,238-acre Las Trampas Creek sub-watershed is predominantly natural, with 79.1 percent of the 64.1 miles of channel containing no obvious reinforcements. Impervious surface in the Las Trampas Creek sub-watershed is calculated at 13.5 percent (CCCDD, 2003). The targeted monitoring location for spring 2018 was located in upper Las Trampas Creek, and due to its location in the watershed, dried up during the summer months. As continuous surface flow stopped mid-summer, an alternate location was selected in Las Trampas Creek for the summer deployment due to discontinuous stream flow at the original monitoring location (Table 2.1).

CCCWP monitored two locations in the Las Trampas Creek watershed during the previous water year, WY 2017, and discovered water temperature and continuous water quality related exceedances (ADH, 2018). As previous years data suggest water temperature in Las Trampas Creek may be negatively affecting its designated beneficial use, continuous water quality was again targeted for monitoring during WY 2018.

2.2.2 Alhambra Creek Watershed

The full watershed of Alhambra Creek is 10,735 acres. The watershed originates in the Briones Hills, encompassed by Briones Regional Park, and travels 7.88 miles to the Carquinez Strait in the City of Martinez. From the Briones Hills, the upper watershed retains a rural character traveling through open tracts and agricultural lands. Upon its descent, the lower watershed maintains a rural feeling at higher elevations, while the flood plain at lower elevations is defined by a heavily urbanized area driven by 100 years of industrialization in the City of Martinez (CCCDD, 2003).

The Alhambra Creek watershed has two major tributaries, Franklin Creek and Arroyo Del Hambre, helping comprise the watershed's total channel length of 48.08 miles. The watershed is predominantly natural, with 87 percent of the channel length containing no obvious reinforcements and 13 percent containing either concrete or earthen reinforcements (CCCDD, 2003).

Historically, steelhead ran up Alhambra Creek from Carquinez Strait. As there are presently no barriers to impede the upstream migration of steelhead on this creek (ADH, 2018), it is probable that a remnant population of steelhead still migrate up Alhambra Creek to spawn, with juvenile fish rearing in the creek for two years before returning to marine waters. Maps of historical and present distribution of steelhead in Contra Costa County indicate Alhambra Creek and its tributaries continue to support small numbers of salmonids (ADH, 2018).

CCCWP monitored two locations in the Alhambra Creek watershed during the previous water year, WY 2017, and discovered water temperature and continuous water quality related exceedances (ADH, 2018). As previous years data suggest water temperature in Alhambra Creek may be negatively affecting its designated beneficial use, two locations were again targeted for monitoring during WY 2018.

2.2.3 San Pablo Creek Watershed

The full watershed of San Pablo Creek is 27,640 acres, arising in the City of Orinda at a maximum elevation of 1,905 feet and flowing westerly 19.65 miles to San Pablo Bay. After leaving Orinda, San Pablo Creek flows across East Bay Municipal Utility District (EBMUD) land into San Pablo Reservoir. Water released from San Pablo Reservoir flows into lower San Pablo Creek, where it crosses first through rural, then heavily urbanized residential and commercial property. Earthen or concrete channelized portions of San Pablo Creek amount to 10.6 percent of the entire channel and occur as it passes through the City of San Pablo. Impervious surface in the San Pablo Creek watershed is calculated at 20 percent (CCCDD, 2003).

San Pablo Creek once supported runs of steelhead and coho (silver) salmon. Leidy et al. (2005) reported that the lower section of San Pablo Creek below the San Pablo Reservoir Dam still had runs of steelhead in the 1950s. However, San Pablo Creek below San Pablo Reservoir is reported by EBMUD to no longer support steelhead/rainbow trout. EBMUD has conducted annual fish sampling of three sites on San Pablo Creek below the reservoir for the past twelve years and found no steelhead/rainbow trout other than a few hatchery rainbow trout that appear to have come from San Pablo Reservoir (personal communication between Scott Cressey and Jessica Purifacto, November 29, 2018).

Currently, there are three barriers present in lower San Pablo Creek that prevent upstream steelhead migration. The first barrier is located where San Pablo Creek flows under Giant Road in North Richmond. The next barrier is the Interstate 80 culvert, followed by another barrier at El Portal Drive in San Pablo. Despite these barriers, the WY 2018 monitoring station was selected to monitor existing conditions within a currently designated steelhead stream.

2.2.4 Pinole Creek Watershed

Pinole Creek is a perennial stream that drains the 9,705-acre Pinole Creek watershed in western Contra Costa County (CCCDD, 2003). With headwaters in the Briones Hills, Pinole Creek flows roughly northwest to San Pablo Bay across oak woodlands, private ranchlands, and lightly developed urban landscapes. The central reaches of Pinole Creek and its tributaries run approximately six miles through a broad open valley with a relatively intact floodplain until reaching the urbanized area around Pinole city limits. The City of Pinole occupies the northern third of the watershed, originally settled in the broad alluvial floodplain of Pinole Creek (CCCDD, 2003). As Pinole Creek descends from the East Bay foothills into the town of Pinole, Interstate 80 forms a man-made margin where the natural stream channel gives

way to confined flood control channels. The length of the longest branch of creek is 10.95 miles with an estimated mean daily flow of 10.4 cubic feet per second (CCCDD, 2003).

In 2014, the Contra Costa Resource Conservation District coordinated a fish passage improvement project under Interstate 80 to mitigate stream flow and velocity problems which presented a barrier to upstream steelhead migration (ADH, 2013). Due to extensive engineering efforts in lower Pinole Creek during the 1950's, channel modifications to restrain floodwaters generated a barrier to upstream migration in both wet and dry seasons. During the dry season, low flows were distributed across two culverts, reducing creek stages to levels too shallow to allow steelhead passage. During the wet season, stream water velocity during storm flows was elevated due to the artificial channel dynamics. The high velocities experienced over shallow depths and long distances constituted an upstream barrier in the creek, where the condition in which stream flow velocity allowed fish passage rarely occurred (ADH, 2013).

Completed in 2016, the fish passage improvement project enables for the upstream migration of steelhead from the lower part of Pinole Creek at the Interstate 80 culvert, upstream to suitable spawning habitat in Upper Pinole Creek. The 2018 HOB0 monitoring location in Pinole Creek was targeted to measure water temperature as it relates to fish habitat in this newly accessible area of Pinole Creek.

2.3 Contra Costa Targeted Monitoring Design

During WY 2018, water temperature, continuous water quality, and pathogen indicators were monitored at the targeted locations listed in Table 2.1 and illustrated in the overview map (Figure 2.2).

Site locations were identified using a targeted monitoring design based on the directed principle⁷ to address the following management questions:

1. What is the range of continuous water quality measurements at targeted sites of interest?
2. Do continuous water quality measurements indicate potential impacts to aquatic life?
3. What are the pathogen indicator concentrations at creek sites where water contact recreation may occur?

Within Contra Costa County, the following targeted monitoring was conducted in WY 2018:

- Four continuous water temperature monitoring locations
- Two continuous water quality monitoring locations
- Five pathogen indicator monitoring locations

⁷ Directed Monitoring Design Principle: A deterministic approach in which points are selected deliberately based on knowledge of their attributes of interest as related to the environmental site being monitored. This principle is also known as "judgmental," "authoritative," "targeted," or "knowledge-based."

Table 2.1 Targeted Sites and Local Reporting Parameters Monitored in Water Year 2018 in Contra Costa County

Site Code	Creek Name	Latitude	Longitude	Temperature	Continuous Water Quality	Pathogen Indicator Bacteria
207ALH015	Alhambra Creek	38.01490	-122.13257	X		
207ALH110	Alhambra Creek	38.00346	-122.12968	X		
206SPA125	San Pablo Creek	37.96621	-122.29918	X	X	
207WAL025	Grayson Creek	37.99699	-122.06491			X
207WAL411	Las Trampas Creek	37.86159	-122.10146		X ¹	
206R00727	Pinole Creek	37.97961	122.26835			X
206R01495	Pinole Creek	37.97889	122.26211	X		
207R01675	Sans Crainte Creek	37.87644	122.02348			X
206R02343	Wildcat Creek	37.96174	-122.35471			X
207R02891	Las Trampas Creek	37.88692	122.09717		X ²	
206R03927	San Pablo Creek	37.96480	122.32364			X

1 Location of spring deployment in Las Trampas Creek

2 Location of summer deployment in Las Trampas Creek

Figure 2.2 Overview of Targeted Sites Monitored by CCCWP in Water Year 2018



This page intentionally blank

3 Monitoring Methods

Targeted monitoring data were collected in accordance with the BASMAA RMC QAPP (BASMAA, 2016a) and BASMAA RMC SOP (BASMAA, 2016b). Where applicable, monitoring data were collected using methods comparable to those specified by the California Surface Water Ambient Monitoring Program (SWAMP) QAPP⁸, and were submitted in SWAMP-compatible format by CCCWP to the SFRWQCB and the CVRWQCB on behalf of CCCWP permittees and pursuant to provision C.8.h.

3.1 Data Collection Methods

Water quality data were collected in accordance with SWAMP-comparable methods and procedures described in the BASMAA RMC SOPs (BASMAA, 2016b) and associated QAPP (BASMAA, 2016a). These documents are updated as needed to maintain current and optimal applicability. The SOPs were developed using a standard format describing health and safety precautions and considerations, relevant training, site selection, and sampling methods and procedures, including pre-fieldwork mobilization activities to prepare equipment, sample collection, and demobilization activities to preserve and transport samples.

The monitoring locations for continuous water quality parameters (dissolved oxygen, specific conductivity, pH, and temperature) were in Las Trampas Creek and San Pablo Creek for this monitoring year, as discussed below.

3.1.1 Continuous Water Quality Measurements

Continuous water quality monitoring equipment (YSI EXO3 and 6600 V2 sondes) were deployed over two time periods at one location in San Pablo Creek and at two locations in Las Trampas Creek. Continuous water quality parameters (dissolved oxygen, specific conductivity, pH, and temperature) were recorded every 15 minutes. The equipment was deployed for two time periods at each creek as follows:

- Las Trampas Creek: Once during spring concurrent with bioassessment sampling at station 207WAL411 (May 8-17) and once during summer at station 207R02891 (September 4-14)
- San Pablo Creek: Once during spring concurrent with bioassessment sampling (May 8-17) and once during summer (September 4-14), with both deployments at station 206SPA125

Procedures used for calibrating, deploying, programming, and downloading data are described in RMC SOP FS-4 (BASMAA, 2016b).

3.1.2 Continuous Temperature Monitoring

In WY 2018, CCCWP monitored water temperature at four locations in the county. Digital temperature loggers (Onset® HOBO® Water Temp Pro V2) were deployed at each of the following locations: Alhambra Creek, San Pablo Creek, and Pinole Creek. Hourly temperature measurements were recorded at each respective site from April 19, 2018 to September 30, 2018.

⁸ The current SWAMP QAPP is available at:
http://www.waterboards.ca.gov/water_issues/programs/swamp/docs/qapp/swamp_qapp_master090108a.pdf

Procedures used for calibrating, deploying, programming and downloading data are described in RMC SOP FS-5 (BASMAA, 2016b).

3.1.3 Pathogen Indicator Sampling

In compliance with permit requirements, a set of pathogen indicator samples was collected on June 28, 2018 at five locations. All five sampling locations were selected based upon their potential to detect anthropogenic sources of contamination or targeted due to site location within public parks, giving increased potential of public contact with waterways. Pathogen indicator samples for enterococci and *E. coli* were analyzed at all sites.

Sampling techniques included direct filling of containers and immediate transfer of samples to analytical laboratories within specified holding time requirements. Procedures used for sampling and transporting samples are described in RMC SOP FS-2 (BASMAA, 2016b).

3.2 Quality Assurance/Quality Control

Data quality assessment and quality control procedures are described in detail in the BASMAA RMC QAPP (BASMAA, 2016a). Data quality objectives (DQOs) were established to ensure data collected are of adequate quality and sufficient for the intended uses. DQOs address both quantitative and qualitative assessment of the acceptability of data. The qualitative goals include representativeness and comparability. The quantitative goals include specifications for completeness, sensitivity (detection and quantization limits), precision, accuracy, and contamination. Data were collected according to the procedures described in the relevant BASMAA RMC SOPs (BASMAA, 2016b), including appropriate documentation of data sheets and samples, and sample handling and custody. Laboratories providing analytical support to the RMC were selected based on the demonstrated capability to adhere to specified protocols.

3.3 Data Quality Assessment Procedures

Following completion of the field and laboratory work, the field data sheets and laboratory reports were reviewed by the local quality assurance officer and compared against the methods and protocols specified in the RMC SOPs and QAPP. The findings and results were then evaluated against the relevant DQOs to provide the basis for an assessment of programmatic data quality. A summary of data quality steps associated with water quality measurements is shown in Table 3.1. The data quality assessment consisted of the following elements:

- Conformance with field and laboratory methods, as specified in RMC SOPs and QAPP, including sample collection and analytical methods, sample preservation, sample holding times, etc.
- Numbers of measurements/samples/analyses completed versus planned, and identification of reasons for any missed samples.
- Temperature data were checked for accuracy by comparing measurements taken by HOBOS with National Institute of Standards Technology thermometer readings in room temperature water and ice water.

- Continuous water quality data were checked for accuracy by comparing measurements taken before and after deployment with measurements taken in standard solutions to evaluate potential drift in readings.
- Quality assessment laboratory procedures for accuracy and precision (i.e., lab duplicates and lab blanks) were not implemented for pathogen samples collected this year but will be in subsequent years.

Table 3.1 Data Quality Steps Implemented for Temperature and Continuous Water Quality Monitoring

Step	Temperature (HOBOS)	Continuous Water Quality (Sondes)
Pre-event calibration / accuracy check conducted	X	X
Readiness review conducted	X	X
Check field datasheets for completeness	X	X
Post-deployment accuracy check conducted		X
Post-sampling event report completed	X	X
Post-event calibration conducted		X
Data review-compare drift against SWAMP MOOs		X
Data review-check for outliers / out of water measurements	X	X

3.4 Data Analysis and Interpretation

Targeted monitoring data were evaluated against WQOs or other applicable thresholds, as described in provision C.8.d of the MRP and Table 8.1 of the Central Valley Permit. Table 3.2 defines thresholds used for selected targeted monitoring parameters as they apply to WY 2018. The subsections below provide details on MRP thresholds and the underlying rationale.

Table 3.2 Requirements for Follow-Up for Local/Targeted Creek Status Monitoring Results Per MRP Provision C.8.d

Constituent	Trigger Level ¹	MRP 2 Provision	Provision Text
Temperature	≥ 2 weekly averages > 17° C (steelhead streams); or 20 percent of results > 24° C instantaneous maximum (per station)	C.8.d.iii.(4)	The temperature trigger is defined as when two or more weekly average temperatures exceed the Maximum Weekly Average Temperature of 17° C for a steelhead stream, or when 20 percent of the results at one sampling station exceed the instantaneous maximum of 24° C. Permittees shall calculate the weekly average temperature by breaking the measurements into non-overlapping, 7-day periods.
Temperature (continuous, sonde)	A weekly average >17° C (steelhead streams); or 20 percent of results >24° C instantaneous maximum (per station)	C.8.d.iv.(4)a.	The Permittees shall calculate the weekly average temperature by separating the measurements into non-overlapping, 7-day periods. The temperature trigger is defined as any of the following: a. Maximum Weekly Average Temperature exceeds 17° C for a steelhead stream, or 20 percent of the instantaneous results exceed 24° C.
pH (continuous, sonde)	≥ 20 percent results < 6.5 or > 8.5	C.8.d.iv.(4)b.	The pH trigger is defined as 20 percent of instantaneous pH results are < 6.5 or > 8.5.
Electrical conductivity (continuous, sonde)	≥ 20 percent results > 2000 µS	C.8.d.iv.(4)c.	The conductivity trigger is defined as 20 percent of the instantaneous specific conductance results are >2000 µS, or there is a spike in readings with no obvious natural explanation.
Dissolved Oxygen (continuous, sonde)	≥ 20 percent results < 7 mg/L (cold water fishery streams)	C.8.d.iv.(4)d.	The dissolved oxygen trigger is defined as 20 percent of instantaneous dissolved oxygen results are < 7 mg/L in a cold water fishery stream.
Enterococci	>130 CFU/100 mL	C.8.d.v.(4)	If USEPA's statistical threshold value for 36 per 1000 primary contact recreators is exceeded, the water body reach shall be identified as a candidate SSID project. (Per RMC/SFBRWQCB staff agreement, CFU and MPN units are deemed to be comparable for this purpose.)
<i>E. coli</i>	> 410 CFU/100 mL	C.8.d.v.(4)	If USEPA's statistical threshold value for 36 per 1000 primary contact recreators is exceeded, the water body reach shall be identified as a candidate SSID project. (Per RMC/SFBRWQCB staff agreement, CFU and MPN units are deemed to be comparable for this purpose.)

¹ Per MRP provision C.8.d., these are the data thresholds which trigger listings as candidate SSID projects per MRP provision C.8.e.

SSID stressor/source identification

CFU colony forming unit

MPN most probable number

3.4.1 Dissolved Oxygen (DO)

The Basin Plan (SFRWQCB, 2015b) lists the applicable WQO for dissolved oxygen in non-tidal waters as follows: 7.0 mg/L minimum for waters designated as COLD (i.e., a steelhead stream). Although this WQO is a suitable criterion for an initial evaluation of water quality impacts, further evaluation may be needed to determine the overall extent and degree to which cold water beneficial uses are supported at a site. For example, further analyses may be necessary at sites in lower reaches of a water body which may not support salmonid spawning or rearing habitat but may be important for upstream or downstream fish migration. In these cases, dissolved oxygen data will be evaluated for the salmonid life stage and/or fish community expected to be present during the monitoring period. Such evaluations of both historical and current ecological conditions will be made, where possible, when evaluating water quality information.

To evaluate the results against the relevant trigger in MRP section C.8.d, the dissolved oxygen data were evaluated to determine whether 20 percent or more of the measurements were below the 7.0 mg/L minimum.

3.4.2 Hydrogen Ion Concentration (pH)

The applicable WQO for pH in surface waters is stated in the Basin Plan (SFRWQCB, 2015b) as follows: the pH shall not be depressed below 6.5 nor raised above 8.5. This range was used in this report to evaluate the pH data collected from creeks.

To evaluate the results against the relevant trigger in MRP provision C.8.d, the pH data were evaluated to determine whether 20 percent or more of the measurements were outside of the WQOs.

3.4.3 Pathogen Indicator Bacteria

In 2012, the U.S. Environmental Protection Agency (USEPA) released its recreational water quality criteria recommendations for protecting human health in all coastal and non-coastal waters designated for primary contact recreation use. The Recreational Water Quality Criteria (RWQC) include two sets of recommendations, as shown in Table 3.3. Primary contact recreation is protected if either set of criteria recommendations are adopted into state water quality standards. However, these recommendations are intended as guidance to states, territories and authorized tribes in developing water quality standards to protect swimmers from exposure to water containing organisms which indicate the presence of fecal contamination. They are not regulations themselves (USEPA, 2012), but are considered to represent “established thresholds” for purposes of evaluating threshold triggers per the MRP and Central Valley Permit.

Section C.8.d.v of the MRP requires use of the USEPA statistical threshold value for the 36/1000 illness rate (“Recommendation 1”; see Table 3.3) for determining if a pathogen indicator collection sample site is a candidate for a stressor/source identification (SSID) project. Because the geometric mean (GM) cannot be determined from the data collected, the MRP also requires use of the standard threshold values (STV) shown in Table 3.3. For data interpretive purposes, CFU and most probable number (MPN) are considered equivalent.

Table 3.3 USEPA 2012 Recreational Water Quality Criteria

Criteria Elements	Recommendation 1 Estimated Illness Rate 36/1,000		Recommendation 2 Estimated Illness Rate 32/1,000	
	GM (CFU/100 mL)	STV ¹ (CFU/100 mL)	GM (CFU/100 mL)	STV (CFU/100 mL)
Enterococci	35	130	30	110
<i>E. coli</i> (fresh)	126	410	100	320

- 1 MRP thresholds
 CFU colony forming unit
 GM geometric mean
 STV standard threshold values

3.4.4 Temperature

Temperature is one indicator of the ability of a water body to support a salmonid fisheries habitat (e.g., a steelhead stream). In California, the beneficial use of a steelhead stream is generally associated with suitable spawning habitat and passage for anadromous fish.

In Section C.8.d.iii.(4) of the MRP, the temperature trigger threshold specification is defined as follows:

“The permittees shall identify a site for which results at one sampling station exceed the applicable temperature trigger or demonstrate a spike in temperature with no obvious natural explanation as a candidate SSID project. The temperature trigger is defined as when two or more weekly average temperatures exceed ... 17° C for a steelhead stream, or when 20 percent of the results at one sampling station exceed the instantaneous maximum of 24° C.”

In Section C.8.d.iv.(4).a of the MRP, which deals with continuous monitoring of dissolved oxygen, temperature and pH, the temperature trigger threshold specification is defined as follows:

“...(the) maximum weekly average temperature (MWAT) exceeds 17° C for a steelhead stream, or 20 percent of the instantaneous results exceed 24° C.”

The first cited section applies to temperature data recorded by the HOBO devices through the period of April to September 2018. The second cited section applies to temperature data recorded by the YSI sonde devices during the two shorter periods in May and September 2018.

In either case, the WAT was calculated as the average of seven daily average temperatures in non-overlapping seven-day periods. In all cases of the recorded temperature data, the first day's data was not included in the WAT calculations to eliminate the probable high bias of the average daily temperature of that day, because the recording devices were all deployed during daylight hours, the typically warmer part of a standard 24-hour day. As the WATs were calculated over the disjunctive seven-day periods, the last periods not containing a full seven days of data were also excluded from the calculations.

In compliance with the cited sections of the MRP, sites for which results exceeded the applicable temperature trigger were identified as candidates for an SSID project in the following three ways:

1. If a site had temperature recorded by a HOBO device, and two or more WATs calculated from the data were above 17° C.
2. If a site had temperature recorded by a YSI sonde device, and one or more WATs calculated from the data were above 17° C. This is equivalent to determining the MWAT at one of these sites was above 17° C for the period in question.
3. If a site had 20 percent of its instantaneous temperature results above 24° C, regardless of the recording device.

As the maximum recorded temperature at all sites during all deployments was 22.44° C, none were identified as SSID candidates based upon the third criterion cited above.

The potential responsive action to the analysis of temperature as it relates to fish habitat in Alhambra Creek, Las Trampas Creek, San Pablo Creek, and Pinole Creek is discussed below. After a brief

description of the site locations monitored, the potential responsive action to the analysis of temperature as it relates to fish habitats follows.

3.4.4.1 Alhambra Creek

Alhambra Creek in Martinez was monitored in WY 2018 at two locations with HOBO water temperature monitoring devices. The upstream monitoring site (207ALH110) was located at the D Street drop structure about 30 feet upstream of D Street, on the upstream end of the drop structure. This location is approximately 1.8 miles from the mouth of Alhambra Creek on the Carquinez Strait. The second monitoring location on Alhambra Creek (207ALH015) was approximately 1.0 mile downstream from the drop structure, next to Martinez Junior High School and roughly 0.8 miles from the mouth of Alhambra Creek where it flows into Carquinez Strait.

The 2015 edition of the Basin Plan for the San Francisco Bay Region designates Alhambra Creek as having both COLD and WARM existing benefits. This indicates the upstream portion of this creek has year-round water temperatures suitably cold to support salmonids, but the lower portions of the creek are too warm to support salmonids through the summer.

Historically, steelhead ran up Alhambra Creek from Carquinez Strait. As there are presently no barriers to impede the upstream migration of steelhead on this creek (ADH, 2018), it is probable a remnant population of steelhead still migrate up Alhambra Creek to spawn, with juvenile fish rearing in the creek for two years before returning to marine waters. During a September 2004 dewatering event at F Street near the Martinez Adult School, an Alhambra Creek Restoration Project found eight steelhead in excellent condition (Leidy et al., 2005). In 2001, electrofishing was conducted by Scott Cressey under contract to Contra Costa County to determine the presence of steelhead and rainbow trout in lower Alhambra Creek. Only one steelhead/rainbow trout was found, a nearly 8-inch fish found just below D Street roughly 250 feet downstream of this year's monitoring location. The captured fish showed no signs of hatchery origin (eroded fins) and were assumed to be wild (ADH, 2018).

The D Street drop structure located approximately 30 feet upstream of the D Street bridge, is a small drop structure associated with a USGS streamflow gauge on Alhambra Creek. In January 2018, Scott Cressey conducted field measurements at the drop structure to investigate whether this structure acts as a potential barrier to upstream steelhead migration. Using criteria set forth by Stuart (Stuart, 1962), field measurements were entered into an equation used to determine 'leaping curves' for steelhead. Measurements concluded the jump pool depth for leaping over a vertical structure were sufficient relative to the crest height of the drop structure present at the upstream bridge. Based on this criterion, it is believed that steelhead would not be impeded by this drop structure during average winter flow conditions. During periods of high storm flows which draw steelhead into the creek, elevated stages would make this drop structure even less of a hinderance (Cressey, 2018).

3.4.4.2 San Pablo Creek

The water quality and water temperature monitoring devices located in San Pablo Creek (206SPA125) were deployed in a section of natural stream near the Earth Island Institute property in El Sobrante. This location is 2.5 miles downstream of the San Pablo reservoir, and 2.5 miles upstream from the mouth in San Pablo Bay. The 2015 edition of the Basin Plan designates San Pablo Creek as having both COLD and WARM beneficial uses.

San Pablo Creek once supported runs of steelhead and coho (silver) salmon. Leidy et al. (2005) reported that the lower section of San Pablo Creek below the San Pablo Reservoir Dam still had runs of steelhead in the 1950s. However, San Pablo Creek below San Pablo Reservoir is reported by EBMUD to no longer support steelhead/rainbow trout. EBMUD has conducted annual fish sampling of three sites on San Pablo Creek below the reservoir for the past twelve years and found no steelhead/rainbow trout other than a few hatchery rainbow trout that appear to have come from San Pablo Reservoir (personal communication between Scott Cressey and Jessica Purifactor, November 29, 2018). As discussed in section 2.2.3, monitoring at San Pablo Creek was specifically targeted at this location in an effort to focus on the creek's potential to support cold water fisheries.

3.4.4.3 Pinole Creek

The WY 2018 water temperature monitoring station (206R01495) on Pinole Creek was located at the beginning of residential development along Pinole Valley Road about 1.2 miles downstream of the intersection with Alhambra Valley Road and 2.1 miles upstream of Interstate 80. The local basin plan designates existing beneficial uses for Pinole Creek as both COLD and WARM, indicating the upstream portion of this creek has year-round water temperatures suitably cold to support salmonids, but the lower portion of the creek is too warm to support salmonids through the summer months (Cressey, 2018).

Pinole Creek has historically sustained a population of steelhead, and several adult steelhead have been observed in the creek during the past decade (Cressey, 2018). In 2007, a report by the Center for Ecosystem Management and Restoration states that 5.8 miles of Pinole Creek are suitable and available habitat for steelhead (Becker et al, 2007). Between the Interstate 80 culvert and San Pablo Bay, Pinole Creek has little spawning and rearing habitat as it is channelized and lacks riparian habitat, exposing the creek to prolonged exposure of solar radiation in the summer months (Cressey, 2018). Personal communication with Bert Mulchaey (January 14, 2014) suggests the suitable steelhead rearing habitat to exist in Pinole Creek extends from Simas Avenue in Pinole to Bear Creek Road in the upper watershed during most years. The 2018 monitoring station on Pinole Creek is located approximately 1.2 miles upstream of Simas Avenue, in an undeveloped location maintaining riparian shading, situated in steelhead rearing habitat (Cressey, 2018).

3.4.4.4 Las Trampas Creek

The 2018 water quality monitoring of Las Trampas Creek was located to monitor the upper reaches of the sub-watershed. General water quality and water temperature measurements were recorded during a period in the month of May near the Lafayette Community Park off St. Mary's Road in Lafayette, but the creek at this location went dry in July following the spring runoff. September water temperature and general water quality measurements were obtained from Las Trampas Creek by moving the monitoring station 0.5 miles downstream to the Olympic Boulevard staging area.

Historically, Las Trampas Creek likely supported a population of steelhead, as steelhead migrated up the Walnut Creek/San Ramon Creek drainage system into which Las Trampas Creek flows. Leidy et al. (2005) states steelhead are no longer in Las Trampas Creek and its tributaries. Drop structures on Walnut Creek immediately below the City of Walnut Creek have prevented steelhead and chinook salmon migration into the watershed for many years (ADH, 2018).

Lafayette Creek, a tributary of Las Trampas Creek, is reported to support rainbow trout, as reported by Bert Mulchaey of EBMUD's East Bay Fishery and Wildlife Division (ADH, 2017). Although it is reported EBMUD has very limited information on Lafayette Creek, the East Bay Fishery and Wildlife Division

believes one would find small sustainable numbers of rainbow trout in the creek. Based on this information, Lafayette Creek and upper Las Trampas Creek may support a viable population of resident rainbow trout in its upper watershed, but there is little evidence of this in Las Trampas Creek to date (ADH, 2018).

This page intentionally blank

4 Results

4.1 Statement of Data Quality

Field data sheets and laboratory reports were reviewed by the local quality assurance officer, and the results were evaluated against the relevant data quality objectives. Results were compiled for qualitative metrics (representativeness and comparability) and quantitative metrics (completeness, precision and accuracy). The following summarizes the results of the data quality assessment:

- Temperature data from HOBOS were collected from four stations. HOBOS were deployed on April 19, 2018 and remained deployed until the pickup date of October 3, 2018. One hundred percent of the expected data was collected at all four locations: San Pablo Creek (206SPA125), Pinole Creek (206R01495), the downstream location of Alhambra Creek (207ALH015) and the upstream location of Alhambra Creek (207ALH110).
- Continuous water quality data (temperature, pH, dissolved oxygen and specific conductance) were collected during the spring and summer seasons; 100 percent of the expected data was collected.
- Quality assurance laboratory procedures were implemented for pathogen indicator analyses this year. All quality assurance samples successfully met data quality objectives.

An assessment of the continuous water quality data related to the data quality objective for accuracy is presented in Table 4.1. All accuracy measurements successfully met the data quality objective.

Table 4.1 Accuracy¹ Measurements Taken for Dissolved Oxygen, pH and Specific Conductivity

Parameter	Measurement Quality Objectives	207WAL411 and 207R02891 Las Trampas Creek		206SPA125 San Pablo Creek	
		May ²	September ³	May	September
Dissolved oxygen (mg/l)	± 0.5 or 10%	0.04	0.07	0.14	0.11
pH 7.0	± 0.2	0.11	0.08	0.16	0.07
pH 10.0	± 0.2	0.07	0.02	0.08	-0.07
Specific conductance (µS/cm)	± 10%	-1.27	-0.84	0.56	-0.01

1 Accuracy of the water quality measurements were determined by calculating the difference between the YSI sonde readings using a calibration standard versus the actual concentration of the calibration standard. The results displayed are those taken following measurements within the stream, defined as "post calibration", as opposed to the "pre calibration values", where all the YSI sonde probes were offset to match the calibration standard prior to deployment.

2 Spring deployment data recorded at site 207WAL411

3 Summer deployment data recorded at site 207R02891

4.2 Water Quality Monitoring Results

4.2.1 Water Temperature (Continuous/HOBO)

Summary statistics for water temperature data collected via HOBOS at the four continuous monitoring locations from April to September 2018 are shown in Table 4.2. At San Pablo Creek, Pinole Creek, and

both Alhambra Creek locations, approximately 165 days of hourly temperature data were collected. All data were collected successfully with no device issues or equipment movement, resulting in 100 percent capture of targeted data. Water temperatures measured at each station, along with the WAT threshold of 17° C for juvenile salmonid rearing, are illustrated in Figures 4.1, 4.2 and 4.3.

Table 4.2 Descriptive Statistics for Continuous Water Temperature Measured at Four Sites in Contra Costa County (Alhambra Creek, San Pablo Creek, and Pinole Creek), April 19-September 30, 2018

Site Temperature	207ALH015	207ALH110	206SPA125	206R01495
	Alhambra Creek (° C)	Alhambra Creek (° C)	San Pablo Creek (° C)	Pinole Creek (° C)
Minimum	12.38	11.78	11.24	10.34
Median	17.72	17.17	15.70	16.27
Mean	17.60	17.06	15.48	16.32
Maximum	22.41	21.19	17.39	21.15
MWAT ¹	19.66	19.17	16.87	18.44
Number of Measurements	3,946	3,948	3,945	3,944

1 The maximum of the 7-day average of the daily average temperature

The minimum and maximum temperature for all four stations was 10.34° C and 22.41° C, respectively. The median temperature range for all four stations was 15.70° C to 17.72° C, and the MWAT range was 16.87° C to 19.66° C.

Figure 4.1 Water Temperature Data Collected at Four Sites in Contra Costa County (Alhambra Creek, San Pablo Creek, and Pinole Creek), April 19-September 30, 2018

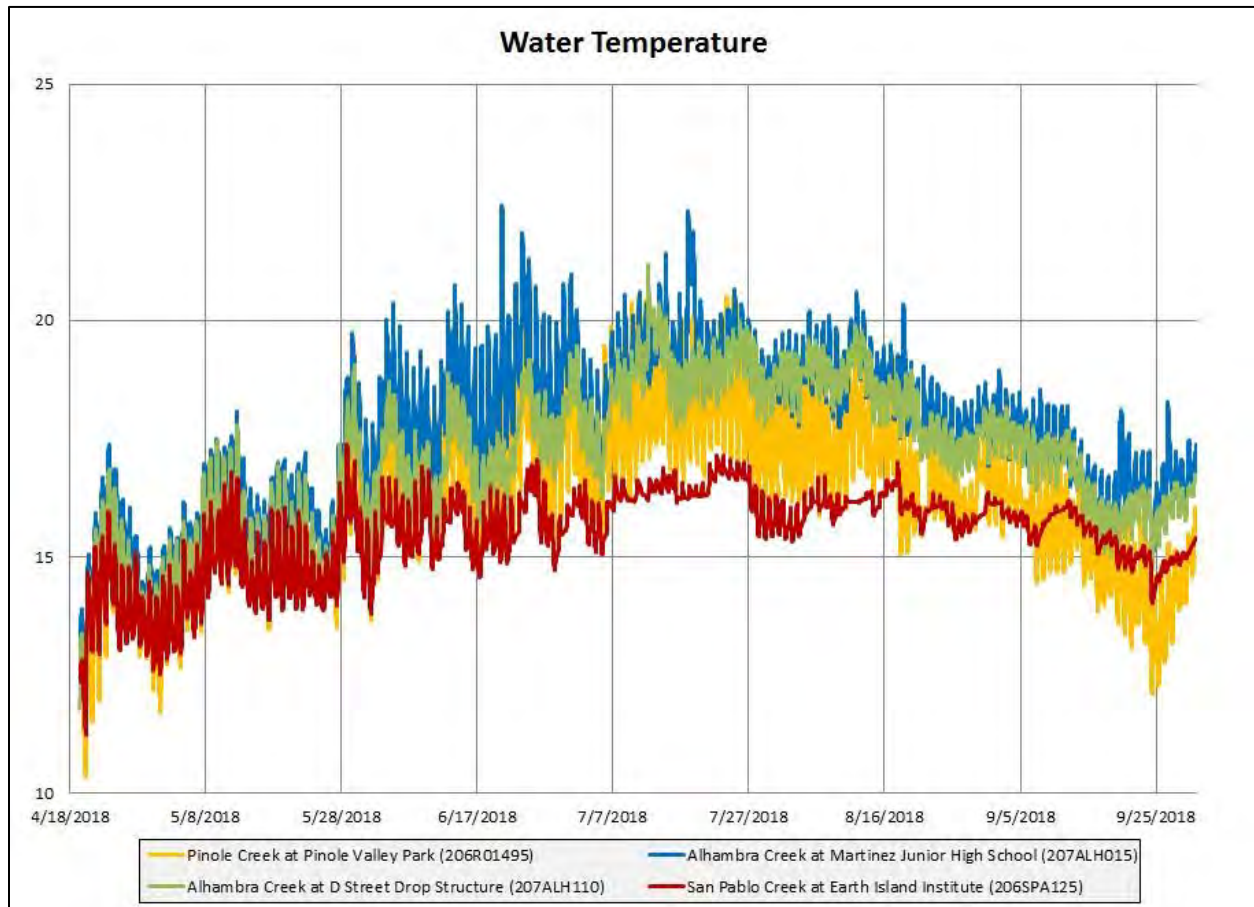

Figure 4.2 Weekly Average Water Temperature Data Collected at Four Sites (Alhambra Creek, San Pablo Creek, and Pinole Creek), April 19-September 30, 2018

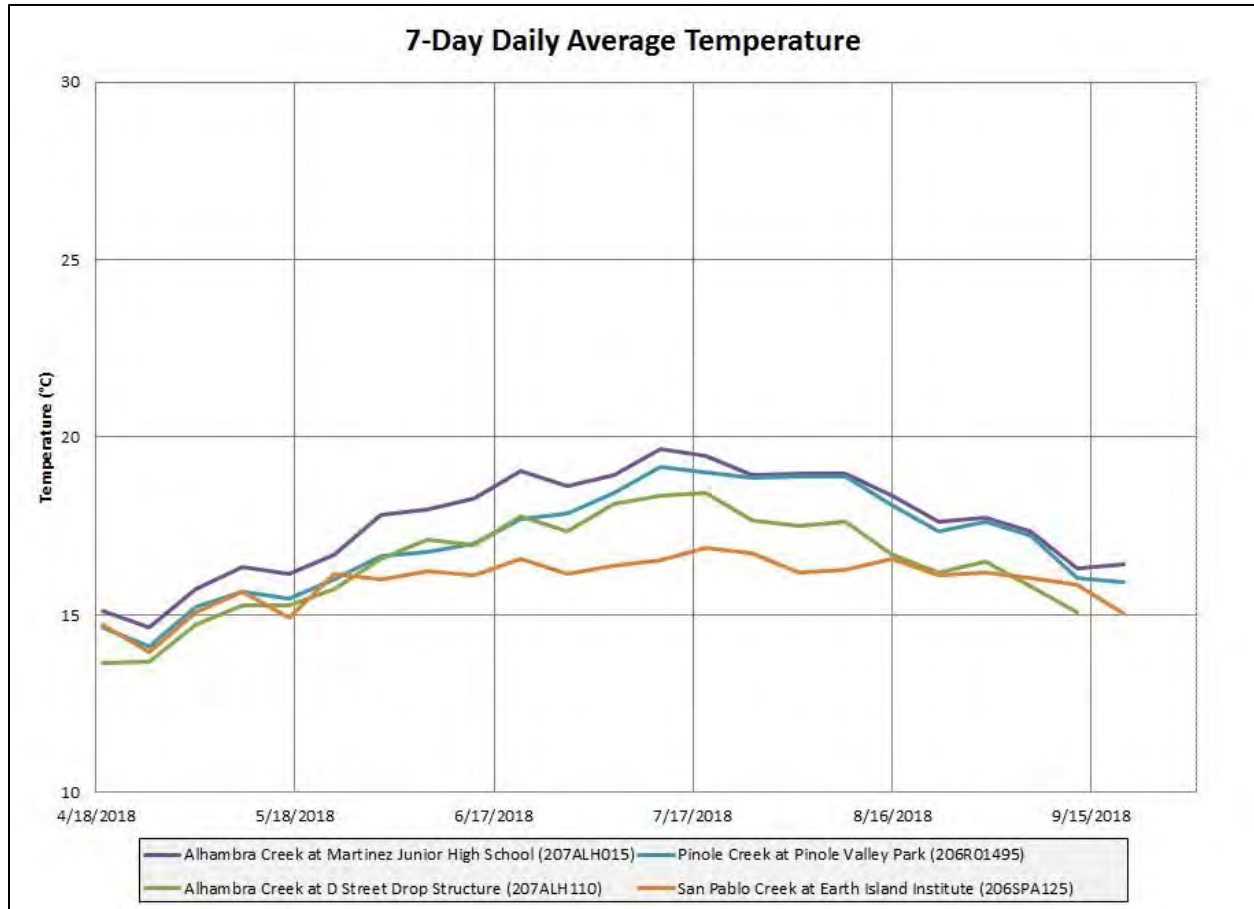
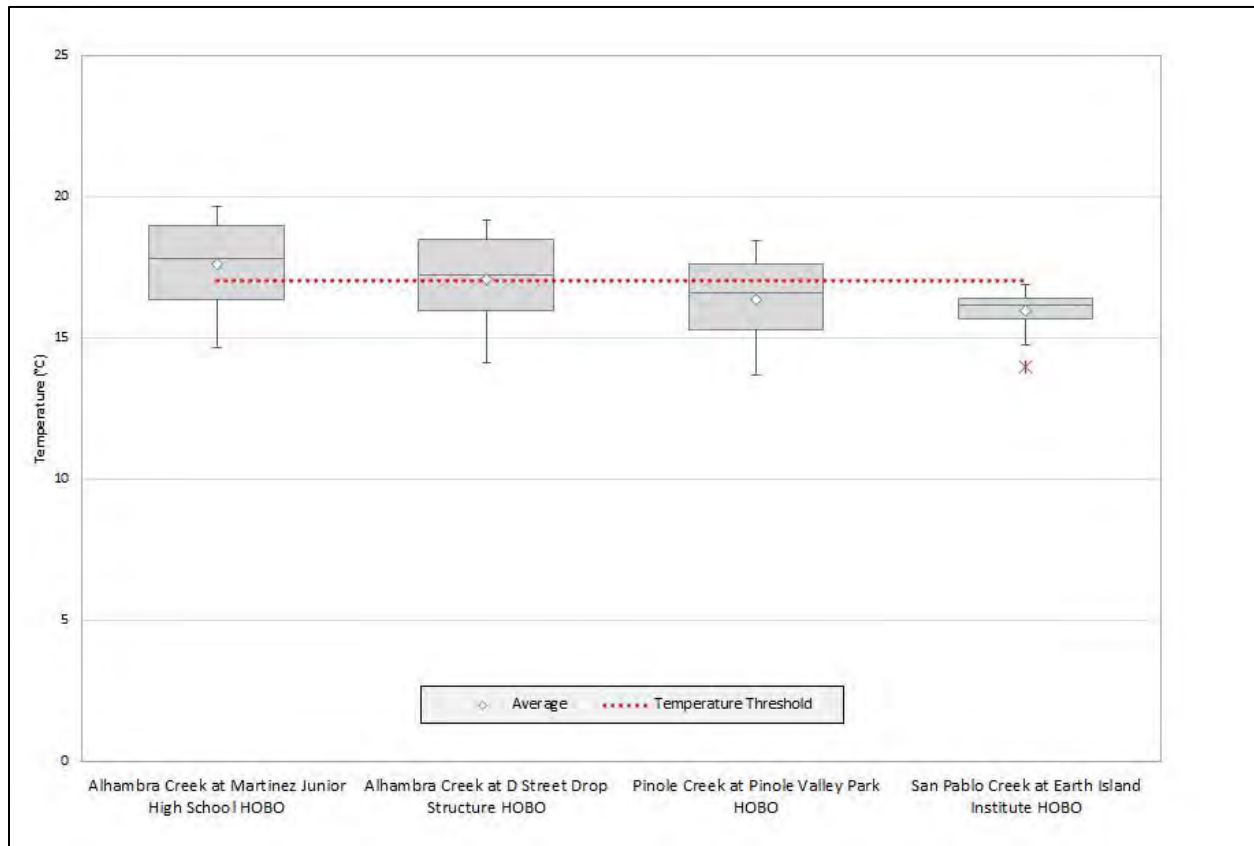

Figure 4.3 Box Plots of Weekly Average Temperature Data Collected at Four Sites in Contra Costa County (Alhambra Creek, San Pablo Creek, and Pinole Creek), April 19-September 30, 2018



As shown in Table 4.3, over the course of the monitoring period, more than two WATs measured at Pinole Creek and both Alhambra Creek locations exceeded the threshold for steelhead streams. The number of exceedances ranged from 9 to 15 instances. Therefore, three out of four stations exceeded the MRP trigger threshold for continuous (HOBO) temperature (two or more WATs over the 17° C threshold; see Table 4.3).

Table 4.3 Water Temperature Data Measured at Four Sites in Comparison to MRP WAT Trigger Threshold for Steelhead Streams

Site ID	Creek Name	Monitoring Period	Number of Results Where WAT > 17° C
207ALH015	Alhambra Creek	April 19-September 30, 2018	15
207ALH110	Alhambra Creek	April 19-September 30, 2018	13
206SPA125	San Pablo Creek	April 19-September 30, 2018	0
206R01495	Pinole Creek	April 19-September 30, 2018	9

4.2.2 Continuous Water Quality

Summary statistics for continuous water quality measurements collected at stations on Las Trampas Creek and San Pablo Creek during two separate periods (once in May and once in September) are shown in Table 4.4. WAT and MWAT for both stations over the same monitoring period are displayed in Table 4.5. Data collected during both periods, along with the required thresholds, are plotted in Figures 4.4 through 4.7.

Table 4.4 Descriptive Statistics for Daily and Monthly Continuous Water Quality Parameters (Temperature, Dissolved Oxygen, Conductivity and pH) Measured in Contra Costa County (Las Trampas Creek and San Pablo Creek), May 8-17 and September 4-14, 2018

Parameter		207WAL411 and 207R02891 Las Trampas Creek		206SPA125 San Pablo Creek	
		May ¹	September ²	May	September
Temperature (°C)	Minimum	13.13	16.53	13.59	15.09
	Median	14.58	17.99	14.76	15.72
	Mean	14.74	18.16	14.84	15.69
	Maximum	16.86	20.02	16.66	16.24
Dissolved oxygen (mg/l)	Minimum	8.02	1.09	3.87	0.46
	Median	8.84	7.08	7.42	5.03
	Mean	9.03	7.06	7.38	4.54
	Maximum	10.41	8.73	8.6	6.83
pH	Minimum	8.11	7.84	7.53	7.46
	Median	8.19	8.04	7.97	7.84
	Mean	8.20	7.95	7.95	7.80
	Maximum	8.33	8.26	8.05	7.97
Specific conductance (µS/cm)	Minimum	914	589	1102	1248
	Median	927	606	1147	1259
	Mean	926	608	1148	1258
	Maximum	933	635	1201	1265

1 Spring deployment measurements recorded at site 207WAL411

2 Summer deployment measurements recorded at site 207R02891

Table 4.5 Maximum Weekly Average Temperatures Measured at Two Sites (Las Trampas Creek and San Pablo Creek) for Both Events

Site Name	Creek Name	Monitoring Period	WAT	MWAT
207WAL411	Las Trampas Creek	May 8-17, 2018	15.17	15.17
207R02891		September 4-14, 2018	18.53	18.53
206SPA125	San Pablo Creek	May 8-17, 2018	15.15	15.15
		September 4-14, 2018	15.62	15.62

Values in Bold exceed MRP criterion of 17.0° C for steelhead streams

Figure 4.4 Continuous Water Quality Data (Temperature) Measured in Contra Costa County (Las Trampas Creek and San Pablo Creek), May 8-17 and September 4-14, 2018

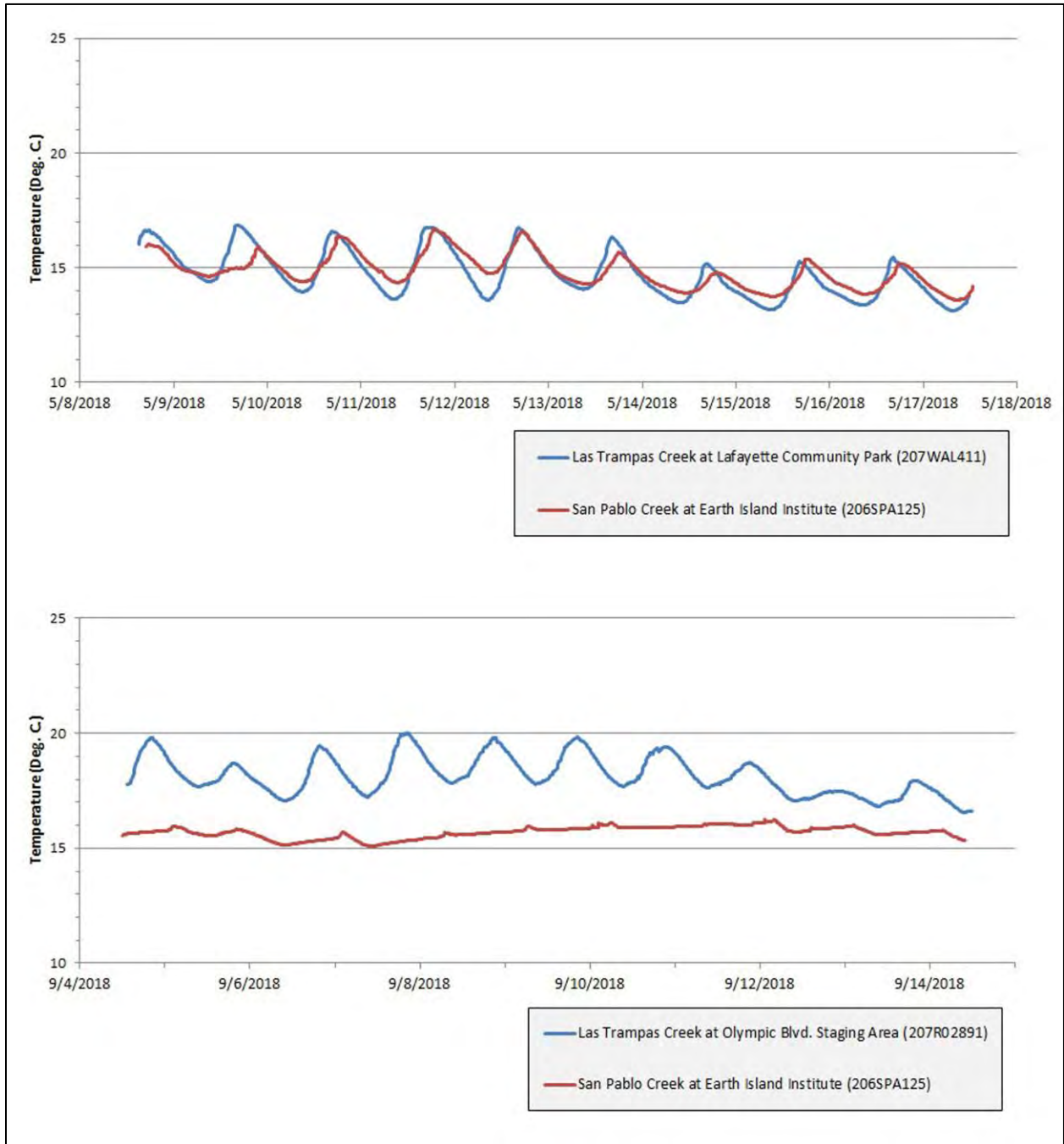

Figure 4.5 Continuous Water Quality Data (pH) Measured in Las Trampas Creek and San Pablo Creek, May 8-17 and September 4-14, 2018

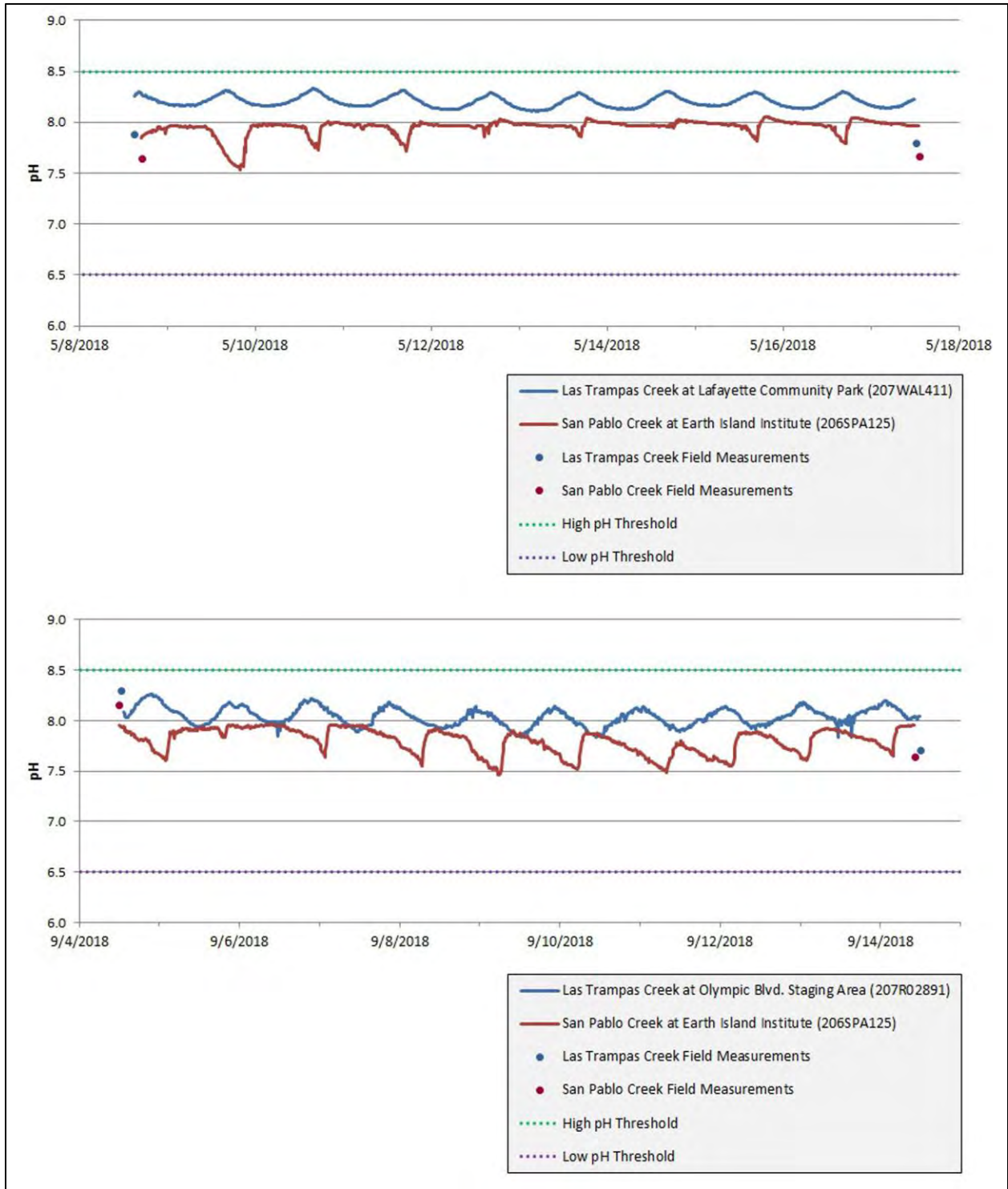

Figure 4.6 Continuous Water Quality Data (Dissolved Oxygen) Measured in Las Trampas Creek and San Pablo Creek, May 8-17 and September 4-14, 2018

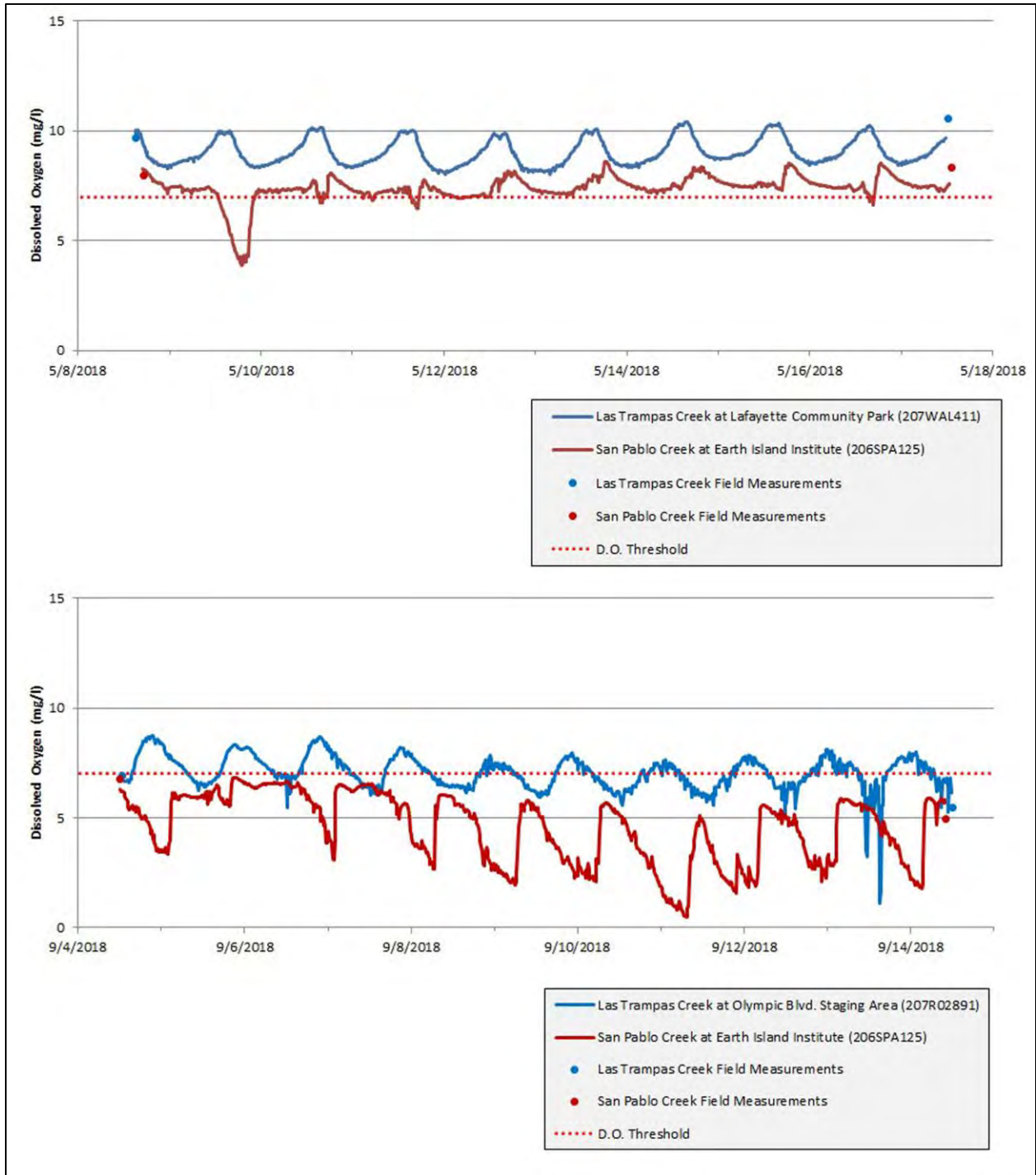
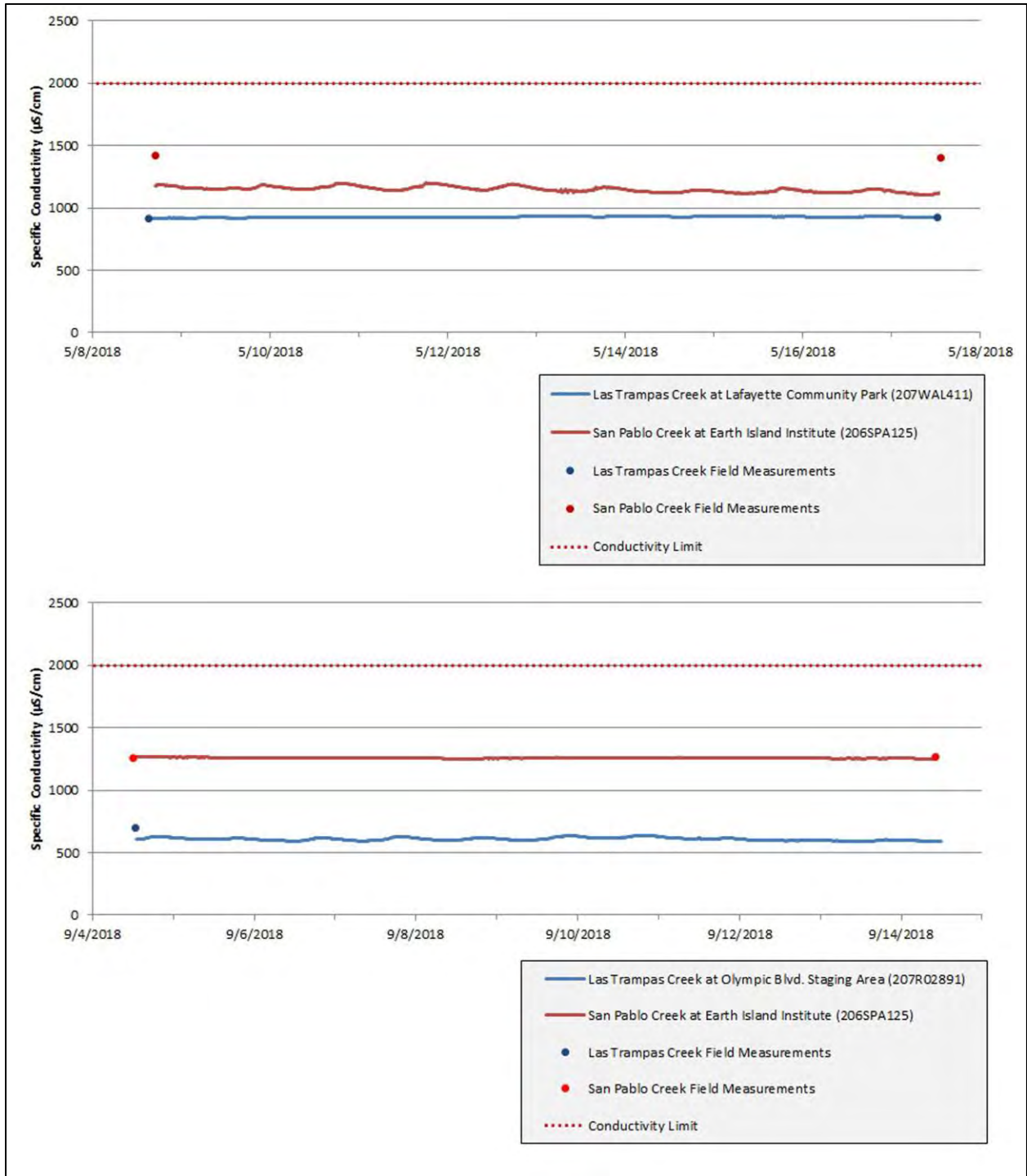

Figure 4.7 Continuous Water Quality Data (Specific Conductivity) Measured in Las Trampas Creek and San Pablo Creek, May 8-17 and September 4-14, 2018



For the May deployment at both stations, continuous water temperature data display a diurnal cycle typical of the region. For the September deployment, continuous water temperature data display a diurnal cycle at the Las Trampas Creek location, while continuous water temperature data at San Pablo Creek display a more consistent temperature over the course of the monitoring period (Figure 4.4), suggesting either an equipment malfunction, or some anomalous condition in the creek during that period. Field crew observations at San Pablo Creek suggest the lack of diurnal curve in September water temperature data can be attributed to instrument deployment depth and location under a heavily shaded riparian canopy over the course of the monitoring period. The San Pablo Creek YSI sonde was placed near the base of a 1.5 meter pool in an area with heavy riparian shading.

During May, the WAT measured at both stations was below the MRP threshold of 17° C for steelhead streams. For the September deployment, the WAT measured at San Pablo Creek was below the MRP threshold, while the Las Trampas Creek station (207R02891) exceeded the MRP threshold (see Table 4.5).

The minimum and maximum pH measurements for San Pablo Creek during both deployment periods were 7.46 and 8.05, respectively. The minimum and maximum pH measurements at Las Trampas Creek during both periods was 7.84 and 8.33, respectively. The Las Trampas Creek pH data display a classic diurnal curve for both the May and September periods.

The lowest DO concentration (0.46 mg/l) at San Pablo Creek occurred during September 2018. The lowest DO concentration (1.09 mg/l) at Las Trampas Creek occurred in September 2018 as well. Again, the Las Trampas Creek DO data display a classic diurnal curve for both the May and September periods, with the notable exception of one steep decline early on September 14, which resulted in the 1.09 mg/L minimum. This downward spike may have been due to some disturbance in the creek.

Continuous conductivity data display readings typical of the region (Figure 4.7). The median concentration of conductivity in San Pablo Creek between the two deployment periods increased slightly from 1,102 µS/cm in May to 1,248 µS/cm in September. This increase can be attributed to a decrease in surface runoff, resulting in an increase of groundwater discharge. Groundwater discharges in the area often percolate through old marine sediment layers, picking up ions and increasing the stream's conductivity in the late summer months.

Table 4.6 presents the percentages of continuous water quality data exceeding the water quality evaluation criteria specified in provision C.8.d of the MRP (see Table 3.3) for specific conductance, dissolved oxygen and pH, as measured at Las Trampas Creek and San Pablo Creek stations during both monitoring periods.

Table 4.6 Percent of Dissolved Oxygen and pH Data Measured at Two Sites (Las Trampas and San Pablo Creek) for Both Events Exceeding Water Quality Evaluation Criteria Identified in Table 3.3

Site Name	Creek Name	Monitoring Period	Specific Conductance	DO Percent Results < 7.0 mg/L	pH Percent Results < 6.5 or > 8.5
207WAL411	Las Trampas Creek	May 8-17, 2018	0%	0%	0%
207R02891		September 4-14, 2018	0%	47%	0%
206SPA125	San Pablo Creek	May 8-17, 2018	0%	9%	0%
		September 4-14, 2018	0%	100%	0%

Following is a summary of water quality evaluation criteria exceedances occurring at either creek.

Las Trampas Creek

During the September 2018 deployment, dissolved oxygen fell below the steelhead stream threshold 47 percent of the time. Therefore, Las Trampas Creek exceeded MRP trigger thresholds for dissolved oxygen (20 percent or more of values exceed the applicable threshold; see Table 3.3) during the September measurement period.

San Pablo Creek

During the September 2018 deployment, dissolved oxygen fell below the steelhead stream threshold 100 percent of the time. Therefore, San Pablo Creek exceeded MRP trigger thresholds for dissolved oxygen (20 percent or more of values exceed the applicable threshold; see Table 3.3) during the September measurement period.

4.2.3 Water Quality Data Evaluation for Steelhead Suitability

The potential responsive action to the analysis of water quality as it relates to fish habitat in Alhambra Creek, Las Trampas Creek, San Pablo Creek and Pinole Creek is discussed below. After a brief discussion of the site results, the potential responsive action to the analysis of water quality as it relates to fish habitat follows.

4.2.3.1 Alhambra Creek – Martinez Junior High School (207ALH015)

Water Temperature

The HOBO monitoring location at this site is the downstream point of two monitoring stations on Alhambra Creek. The median water temperature at this location was 17.72° C and its MWAT was 19.66° C (see Table 4.2). The 17° C WAT criterion was exceeded on 15 occasions, with all WAT exceedances occurring from May 31-September 12, 2018.

The HOBO water temperature results at this location indicate that lower Alhambra Creek through Martinez is unlikely to support steelhead/rainbow trout through the summer months. Steelhead migrating up Alhambra Creek are assumed to move up to headwaters more suitable for spawning and rearing, using this location through lower Alhambra Creek as a winter and spring migration corridor. Frequent exceedance of the WAT criterion indicates lower Alhambra Creek provides migration passage habitat, but no or marginal summer rearing habitat for steelhead or anadromous salmonids (Cressey, 2018).

4.2.3.2 Alhambra Creek – D Street Drop Structure (207ALH110)

Water Temperature

The HOBO monitoring location at this site is the upstream point of two monitoring stations on Alhambra Creek. The median water temperature at this location was 17.17° C and the MWAT was 19.17° C (see Table 4.2). The 17° C WAT criterion was exceeded on 13 occasions, with all WAT exceedances occurring from June 14-September 12, 2018.

Located in a deeply shaded pool one mile further up the watershed than station 207ALH015, summer temperatures at this location in Alhambra Creek are marginal or prohibitive for steelhead rearing. Although these water temperatures suggest this location is unlikely to support steelhead/rainbow trout through the summer months, the basin plan designates Alhambra Creek's existing beneficial uses as both COLD and WARM habitat, showing awareness that the lower end of Alhambra Creek largely serves as a winter and spring migration corridor for steelhead/rainbow trout (Cressey, 2018).

4.2.3.3 Pinole Creek – Pinole Valley Park (206R01495)

Water Temperature

At the Pinole Creek HOB0 monitoring station, the median water temperature in this stream was 16.27° C and the MWAT was 18.44° C (see Table 4.2). The 17° C WAT criterion was exceeded on 9 occasions, once during the week of June 7-13, and 8 times during the monitoring period from June 21-August 15, 2018.

Pinole Creek failed to meet WAT temperature criteria for a steelhead stream. As the 2018 HOB0 monitoring station was located two thirds of the way up Pinole Valley and just on the eastern edge of substantial residential development, the failure of the creek water temperature to meet the WAT criterion is surprising and should be investigated in 2019 (Cressey, 2018).

4.2.3.4 San Pablo Creek – Earth Island Institute (206SPA125)

Water Temperature

During the 2018 monitoring period, the San Pablo Creek HOB0 monitoring station had a median water temperature of 15.70° C and MWAT of 16.87° C (see Table 4.2). Water temperature criterion at this location did not exceed the 17° C WAT criterion for a steelhead stream on any occasion during the monitoring period (see Table 4.3).

As shown in Table 4.4, the YSI sonde monitoring location at San Pablo Creek recorded a median temperature of 14.76° C and 15.72° C for the May and September deployments, respectively. The MWAT over the two deployment periods was 15.15° C and 15.62° C (see Table 4.5). The temperature criterion at the YSI sonde monitoring location during the May and September deployments did not exceed the 17° C threshold criterion. Summer temperatures recorded in this portion of San Pablo Creek were consistently below MRP threshold criterion, indicating water temperature in this location are suitable for the designated beneficial use for COLD water fisheries. Although San Pablo Creek once supported steelhead, the construction of San Pablo reservoir prevents steelhead from reaching the spawning and rearing habitat in the upper portion of the creek (Cressey, 2018).

Dissolved Oxygen

Dissolved oxygen levels during the May deployment dropped below the minimum steelhead stream criterion of 7.0 mg/L for 9 percent of the recorded monitoring period. As this is below the 20 percent threshold, these measurements do not exceed the MRP criterion for follow-up.

During the September deployment period, dissolved oxygen levels in San Pablo Creek failed to meet the steelhead stream criterion of 7.0 mg/L for 100 percent of the recorded monitoring period.

pH

The pH of San Pablo Creek always met the MRP criterion during the monitoring period (see Table 4.6).

Specific Conductance

The specific conductance of San Pablo Creek always met the MRP criterion during the monitoring period (see Table 4.6). The median specific conductance of 1,147 $\mu\text{S}/\text{cm}$ to 1,259 $\mu\text{S}/\text{cm}$ is normal for the region.

4.2.3.5 Las Trampas Creek – Lafayette Community Park (207WAL411)**Water Temperature**

The upstream station of the two YSI monitoring locations along Las Trampas Creek, site 207WAL411, was monitored during the May deployment period. The median water temperature in this stream was 14.58° C (see Table 4.4) and the MWAT was 15.17° C (see Table 4.5). Temperature measurements at the YSI sonde monitoring location during the May deployment did not exceed the 17° C WAT criterion, therefore meeting steelhead stream criteria.

Dissolved Oxygen (DO)

DO levels in Las Trampas Creek during the May deployment did not drop below the minimum in-stream habitat criterion of 7.0 mg/L. Therefore, dissolved oxygen levels of Las Trampas Creek always met the MRP criterion during the May monitoring period (see Table 4.6).

pH

The pH of Las Trampas Creek always met the MRP criterion during the monitoring period (see Table 4.6).

Specific Conductance

The specific conductance of Las Trampas Creek always met the MRP criterion during the May deployment (see Table 4.6).

4.2.3.6 Las Trampas Creek – Olympic Boulevard Staging Area (207R02891)**Water Temperature**

The downstream station of the two YSI monitoring locations along Las Trampas Creek, site 207R02891, was monitored during the September deployment period. The median water temperature in this stream was 17.99° C (see Table 4.4) and the MWAT was 18.53° C (see Table 4.5). The temperature measurements at the YSI sonde monitoring location during the September deployment exceeded the MRP 17° C threshold.

As was recorded in WY 2017 (ADH, 2018), the area of Las Trampas Creek from at least the Olympic Boulevard Staging Area downstream typically fails to meet criteria for water temperature for steelhead streams. As the Basin Plan recognizes Las Trampas Creek as having both WARM and COLD beneficial uses, it suggests that there are likely cold water conditions suitable for steelhead trout year-round in the upper drainage, but not in the warmer portion of the creek below the City of Lafayette.

Dissolved Oxygen

During the September deployment period in Las Trampas Creek, 47 percent of results failed to meet the minimum dissolved oxygen criterion, exceeding the MRP threshold of 20 percent instantaneous results < 7.0 mg/L.

These dissolved oxygen results further suggest that this area of Las Trampas Creek may provide steelhead migration habitat, but no rearing habitat during the summer. Depressed dissolved oxygen levels eliminate steelhead rearing habitat at this location (Cressey, 2018).

pH

The pH of Las Trampas Creek always met the MRP criterion during the September monitoring period (see Table 4.6).

Specific Conductance

The specific conductance of Las Trampas Creek always met the MRP criterion during the September monitoring period (see Table 4.6).

4.3 Pathogen Indicator Bacteria

In compliance with MRP provision C.8.d and Central Valley Permit provision C.8.c, a set of pathogen indicator samples were collected on June 28, 2018 at five stations on creeks in Contra Costa County (Table 4.7). They were analyzed for enterococci and *E. coli*. The sites were located along Wildcat Creek, Pinole Creek, Sans Crainte Creek, San Pablo Creek, and Grayson Creek. Due to their proximity to either a public park or illegal encampment, all sites were targeted to investigate if the water quality could be impacted by regular human recreational activity, such as off-leash dog parks or other activities suspected with illegal encampments. All sites were chosen based upon the likelihood of water contact recreation or to investigate areas of possible anthropogenically-induced contamination.

As described previously (Section 3.4.3), single sample maximum concentrations of 130 CFU/100ml enterococci and 410 CFU/100ml *E. coli* were used for evaluation, based on the most recently published recreational water quality criteria statistical threshold values for water contact recreation (USEPA, 2012). Enterococci concentrations ranged from 28 to 579 CFU/100 ml and *E. coli* concentrations ranged from 59 to 517 CFU/100 ml. Two enterococci samples exceeded the applicable criterion, while two samples collected for *E. coli* exceeded the applicable USEPA criterion. Samples collected at 207R01675 (Sans Crainte Creek) exceeded criteria for both *E. coli* and enterococci, while one sample collected at 207R0WAL025 (Grayson Creek) exceeded only the *E. coli* criterion and one sample collected at Wildcat Creek (206R02343) exceeded only the enterococci criterion.

Table 4.7 Enterococci and *E. coli* Levels Measured from Water Samples Collected at Five Locations in Creeks in Contra Costa County (June 28, 2018)

Site ID	Creek Name	Enterococci (CFU/100ml)	<i>E. coli</i> (CFU/100ml)
207WAL025	Grayson Creek	63	517 ²
206R00727	Pinole Creek	28	121
207R01675	Sans Crainte Creek	579 ¹	461 ²
206R02343	Wildcat Creek	388 ¹	59
206R03927	San Pablo Creek	73	172

1 Exceeded USEPA criterion of 130 CFU/100ml enterococci

2 Exceeded USEPA criterion of 410 CFU/100ml *E. coli*

This page intentionally blank

5 Next Steps

Under the requirements of provision C.8 in the MRP and the Central Valley Permit, the following next step will be taken: CCCWP will continue to conduct monitoring for local/targeted parameters in WY 2019.

Table 5.1 Summary of CCCWP Threshold Exceedances for Water Year 2018

Creek	Index Period	Parameter	Threshold Exceedance
Alhambra Creek at Martinez Junior High School	May 31-September 12, 2018	Continuous Water Temperature (HOBO)	More than two WATs exceed 17° C
Alhambra Creek at D Street Drop Structure	June 14-September 12, 2018	Continuous Water Temperature (HOBO)	More than two WATs exceed 17° C
Pinole Creek	June 7-13, 2018; June 21-August 15, 2018	Continuous Water Temperature (HOBO)	More than two WATs exceed 17° C
Las Trampas Creek at Olympic Blvd. Staging Area	September 4-14, 2018	Continuous Water Temperature (sonde)	One WAT exceeds 17° C
Las Trampas Creek at Olympic Blvd. Staging Area	September 4-14, 2018	Continuous Water Quality - DO	20 percent of instantaneous results below 7.0 mg/L
San Pablo Creek	September 4-14, 2018	Continuous Water Quality - DO	20 percent of instantaneous results below 7.0 mg/L
Sans Crainte Creek	June 28, 2018	Enterococci	Single grab sample exceeded USEPA criterion of 130 CFU/100 ml
Wildcat Creek	June 28, 2018	Enterococci	Single grab sample exceeded USEPA criterion of 130 CFU/100 ml
Sans Crainte Creek	June 28, 2018	E. coli	Single grab sample exceeded USEPA criterion of 410 CFU/100 ml
Grayson Creek	June 28, 2018	E. coli	Single grab sample exceeded USEPA criterion of 410 CFU/100 ml

WAT weekly average temperature

DO dissolved oxygen

CFU colony forming unit

This page intentionally blank

6 References

- ADH Environmental (ADH). 2013. Local Urban Creeks Monitoring Report. Prepared for the Contra Costa Clean Water Program. March 2013.
- ADH Environmental (ADH). 2017. Local Urban Creeks Monitoring Report. Prepared for the Contra Costa Clean Water Program. March 2017.
- ADH Environmental (ADH). 2018. Local Urban Creeks Monitoring Report. Prepared for the Contra Costa Clean Water Program. March 2018.
- Armand Ruby Consulting (ARC). 2019. Regional/Probabilistic Creek Status Monitoring Report. Prepared for the Contra Costa Clean Water Program. March 2019.
- Bay Area Stormwater Management Agencies Association (BASMAA). 2016a. Regional Monitoring Coalition Creek Status and Pesticides & Toxicity Monitoring Program Quality Assurance Project Plan. Version 3, March 2016.
- Bay Area Stormwater Management Agencies Association (BASMAA). 2016b. Regional Monitoring Coalition Creek Status and Pesticides & Toxicity Monitoring Standard Operating Procedures. Prepared by EOA, Inc. and Applied Marine Sciences. Version 3, March 2016.
- Contra Costa County Development Department (CCCDD). 2003. Contra Costa County Watershed Atlas. Prepared by the Contra Costa County Community Development Department in cooperation with the Contra Costa County Public Works Department under the direction of the Contra Costa County Board of Supervisors. January 2003.
- Cressey, S. 2016. Review of 2016 Water Quality Monitoring Data for Lafayette, Las Trampas, Rimer and West Branch Alamo Creeks in Contra Costa County. Prepared for ADH Environmental and the Contra Costa County Clean Water Program. December 22, 2015.
- Cressey, S. 2017. Review of 2017 Water Quality Monitoring Data for Alhambra, Franklin, and Las Trampas Creeks in Contra Costa County. Prepared for ADH Environmental and the Contra Costa County Clean Water Program. December 12, 2017.
- Cressey, S. 2018. Review of 2018 Water Quality Monitoring Data for Las Trampas, San Pablo, Alhambra and Pinole Creeks in Contra Costa County. Prepared for ADH Environmental and the Contra Costa County Clean Water Program. December 6, 2018.
- California Regional Water Quality Control Board, Central Valley (CVRWQCB). 2010. Stormwater NPDES Waste Discharge Requirements Order R5-2010-0102 NPDES Permit No. CAS083313. September 23, 2010.
- EOA, Inc. and Armand Ruby Consulting (EOA and ARC). 2011. Regional Monitoring Coalition, Creek Status and Long-Term Trends Monitoring Plan. Prepared for Bay Area Stormwater Management Agencies Association. November 28, 2011.
- Leidy, R.A., Becker, G.S., and Harvey, B.N. 2005. Historical Distribution and Current Status of Steelhead/Rainbow Trout (*Oncorhynchus Mykiss*) in Streams of the San Francisco Estuary, California. Center for Ecosystem Management and Restoration, Oakland, California. 2005.

- San Francisco Bay Regional Water Quality Control Board (SFRWQCB). 2009. Municipal Regional Stormwater NPDES Permit. Waste Discharge Requirements Order R2-2009-0074. NPDES Permit No. CAS612008. October 14, 2009.
- San Francisco Bay Regional Water Quality Control Board (SFRWQCB). 2015a. Municipal Regional Stormwater NPDES Permit. Waste Discharge Requirements Order R2-2015-0049. NPDES Permit No. CAS612008. November 19, 2015.
- San Francisco Bay Regional Water Quality Control Board (SFRWQCB). 2015b. Water Quality Control Plan (Basin Plan) for the San Francisco Bay Basin. San Francisco Regional Water Quality Control Board. March 2015.
http://www.waterboards.ca.gov/sanfranciscobay/basin_planning.shtml.
- Stuart, T.A. 1962. Leaping Behavior of Salmon and Trout at Falls and Obstructions. Department of Agriculture and Fisheries of Scotland. 46pp. 1962.
- U.S. Environmental Protection Agency (USEPA). 1986. Quality Criteria for Water 1986. U.S. Environmental Protection Agency. EPA-440/5-86-001. May 1, 1986. Office of Water Regulations and Standards, Washington, D.C., USA.
- U.S. Environmental Protection Agency (USEPA). 2011. Draft Recreational Water Quality Criteria. EPA-HQ-RW-2011-0466. Updated November 14, 2014. See:
<http://water.epa.gov/scitech/swguidance/standards/criteria/health/recreation/>
- U.S. Environmental Protection Agency (USEPA). 2012. Recreational Water Quality Criteria. EPA-820-F-12-061. 2 p. Fact Sheet. December 2012.
- Walking, Rich. 2013. Walnut Creek Watershed Inventory. Prepared for the Walnut Creek Watershed Council. February 2013.

Appendix 3

BASMAA Regional Monitoring Coalition

- A. Regional Stressor/Source Identification (SSID) Report, MRP 2.0 SSID Project Locations, Rationales and Status***
- B. PCBs from Electrical Utilities in San Francisco Bay Area Watersheds, Stressor/Source Identification (SSID), Project Work Plan***

This page intentionally blank

BASMAA Regional Monitoring Coalition
Regional Stressor/Source Identification (SSID) Report, prepared in compliance with Municipal Regional Stormwater NPDES Permit (MRP; Order No. R2-2015-0049) Provision C.8.e.ii(1)
MRP 2.0 SSID Project Locations, Rationales, Status
Updated March 2019

SSID Project ID	Date Updated	County/Program	Creek/Channel Name	Site Code(s) or Other Site ID	Project Title	Primary Indicator(s) Triggering Stressor/Source ID Project									Indicator Result Summary	Rationale for Proposing/Selecting Project	Current Status of SSID Project or Date Completed	EO Concurrence of Project Completion (per C.8.e.iii.(b))
						Bioassessment	General WQ	Chlorine	Temp	Water Tox	Sed Tox	Sed Chem	Pathogen Indicators	Other				
AL-1	01/14/19	ACCWP	Palo Seco Creek		Exploring Unexpected CSCI Results and the Impacts of Restoration Activities	X									Sites where there is a substantial difference in CSCI score observed at a location relative to upstream or downstream sites, including sites on Palo Seco Creek upstream of the Sausal Creek restoration-related sites, that had substantial and unexpected differences in CSCI scores.	The project will provide additional data to aid consideration of unexpected and unexplained CSCI results from previous water year sampling on Palo Seco Creek, enable a more focused study of monitoring data collected over many years in a single watershed, and allow analysis of before and after data at sites upstream and downstream of previously completed restoration activities.	The work plan was submitted in August 2018. WY 2018 sampling and monitoring took place April - September and the data are currently being processed.	
AL-2	03/05/19	ACCWP	Arroyo Las Positas		Arroyo las Positas Stressor Source Identification Project	X									CSCI scores below the threshold were recorded on Arroyo Las Positas in WYs 2016 and 2017. In 2017, one site exceeded the Basin Plan threshold for chloride. The creek is also listed on the 303(d) list for eutrophication and has an approved TMDL for Diazinon.	ACCWP is exploring a potential SSID project on Arroyo las Positas. The Water Board is conducting sampling in the watershed as part of its TMDL development efforts, and an SSID project may combine well with those efforts and generate a better overall picture of stressors impacting the waterbody.	The SSID project is under development. The final SSID project may end up focusing on a different waterbody, depending on the outcome of communications with Water Board staff and analysis of WY 2018 triggers.	
CC-1	01/02/19	CCCWP	Lower Marsh Creek		Marsh Creek Stressor Source Identification Study								X		9 fish kills were documented in Marsh Creek between September 2005 and October 2017. A conclusive cause has not been identified.	This SSID study addresses the root causes of fish kills in Marsh Creek. Monitoring data collected by CCCWP and other parties are being used to investigate multiple potential causes, including low dissolved oxygen, warm temperatures, daily pH swings, fluctuating flows, physical stranding, and pesticide exposure.	The CCCWP SSID work plan was submitted in 2018 and is currently being implemented. The Year 1 Status Report is included in this WY 2018 UCMR.	
SC-1	01/12/19	SCVURPPP	Coyote Creek	NA	Coyote Creek Toxicity SSID Project									X	The SWRCB recently added Coyote Creek to the 303(d) list for toxicity.	This SSID study is investigating sources of toxicity to sediments in Coyote Creek. Results of sediment toxicity and chemistry monitoring conducted during the WY 2018 dry season were inconclusive. Sediment chemistry results were inconclusive, and toxicity results too inconsistent to proceed with a TIE study. The WY 2018 results support earlier findings from	The work plan was submitted with SCVURPPP's WY 2017 UCMR. A project report describing the results of the WY 2018 and WY 2019 monitoring will be submitted with the WY 2019 UCMR.	

SSID Project ID	Date Updated	County/Program	Creek/Channel Name	Site Code(s) or Other Site ID	Project Title	Primary Indicator(s) Triggering Stressor/Source ID Project									Indicator Result Summary	Rationale for Proposing/Selecting Project	Current Status of SSID Project or Date Completed	EO Concurrence of Project Completion (per C.8.e.iii.(b))
						Bioassessment	General WQ	Chlorine	Temp	Water Tox	Sed Tox	Sed Chem	Pathogen Indicators	Other				
															SCVURPPP and SPoT that toxicity and pesticide concentrations in Coyote Creek are sporadic. Additional monitoring will be conducted in WY 2019 to confirm the findings.			
SC-2	02/19/19	SCVURPPP	TBD	TBD	TBD									TBD	TBD	Project options currently under discussion by Monitoring Ad Hoc Task Group		
SM-1	01/12/19	SMCWPPP	Pillar Point / Deer Creek / Denniston Creek	NA	Pillar Point Harbor Bacteria SSID Project								X	FIB samples from 2008, 2011-2012 exceeded WQOs	A grant-funded Pillar Point Harbor MST study conducted by the RCD and UC Davis in 2008, 2011-2012 pointed to urban runoff as a primary contributor to bacteria at Capistrano Beach and Pillar Point Harbor. The study, however, did not identify the specific urban locations or types of bacteria. This SSID project is investigating bacteria contributions from the urban areas within the watershed. In WY 2018, pathogen indicator and MST monitoring were conducted at 14 fresh water sites during 2 wet and 2 dry events. Very few samples contained "controllable" source markers (i.e., human and dog). Additional field studies are being conducted in WY 2019 to understand hydrology and specific source areas.	The work plan was submitted with SMCWPPP's WY 2017 UCMR. A project report describing the results of the WY 2018 and WY 2019 investigations will be submitted with the WY 2019 UCMR.		
FSV-1	02/04/19	City of Vallejo in association with FSURMP	Rindler Creek	207R03504	Rindler Creek Bacteria and Nitrogen Study								X	E. coli result of 2800 MPN/100mL in September 2017	A source identification study is warranted in Rindler Creek due to the elevated FIB result, other (non-RMC) monitoring indicating elevated ammonia levels, and the presence of a suspected pollutant source upstream of the data collection point. Rindler Creek is a highly urbanized and modified creek that originates in open space northeast of the City of	Project planning is proceeding in FY 2018-19. Follow-up monitoring is being performed during early 2019 to verify the spatial and temporal extent of the water quality issues during the grazing period.		

SSID Project ID	Date Updated	County/Program	Creek/Channel Name	Site Code(s) or Other Site ID	Project Title	Primary Indicator(s) Triggering Stressor/Source ID Project									Indicator Result Summary	Rationale for Proposing/Selecting Project	Current Status of SSID Project or Date Completed	EO Concurrence of Project Completion (per C.8.e.iii.(b))
						Bioassessment	General WQ	Chlorine	Temp	Water Tox	Sed Tox	Sed Chem	Pathogen Indicators	Other				
															Vallejo. Monitoring is conducted just downstream of the creek crossing under Columbus Parkway; upstream of this site there is City-owned land that is grazed by cattle roughly from December-June.			
RMC-1	01/12/19	RMC/Regional	NA (entire RMC area)	NA	Regional SSID Project: Electrical Utilities as a Potential PCBs Source to Stormwater in the San Francisco Bay Area									X	Fish tissue monitoring in San Francisco Bay led to the Bay being designated as impaired on the CWA 303(d) list and the adoption of a TMDL for PCBs in 2008. POC monitoring suggests diffuse PCB sources throughout region.	PCBs were historically used in electrical utility equipment, some of which still contain PCBs. Although much of the equipment has been removed from services, ongoing releases and spills may be occurring at levels approaching the TMDL waste load allocation. This regional SSID project will investigate opportunities for BASMAA RMC partners to work with RWQCB staff to 1) improve knowledge about the extent and magnitude of PCB releases and spills, 2) improve the flow of information from utility companies, and 3) compel cooperation from utility companies to implement improved control measures.	A work plan is currently under development and is anticipated for submittal with the WY 2018 UCMRs.	

PCBs from Electrical Utilities in San Francisco Bay Area Watersheds Stressor/Source Identification (SSID)

*Prepared in support of provision C.8.e.iii of
NPDES Permit # CAS612008*

Project Work Plan



Prepared for:

Bay Area Stormwater Management Agencies Association (BASMAA)

Prepared by:

EOA, Inc.
1410 Jackson St.
Oakland, CA 94612

FINAL March 2019

Table of Contents

Table of Contents.....	i
List of Tables	ii
List of Figures	ii
1.0 Introduction	1
1.1 Overview of SSID Project Requirements.....	1
1.2 SSID Work Plan Organization.....	2
2.0 Problem Definition, Study Objectives, and Regulatory Background.....	3
2.1 Problem Definition.....	3
2.2 SSID Project Objectives.....	4
2.3 Management Questions.....	5
2.4 Regulatory Context of PCBs WQOs.....	5
3.0 Study Area, Existing Data, and Potential Causes of Water Quality Problem.....	6
3.1 Study Area.....	6
3.2 Existing Data.....	8
3.2.1 Regulatory Controls on PCBs in Electrical Utility Equipment.....	8
3.2.2 PCBs Remaining in Electrical Utility Equipment.....	8
3.2.3 Estimated Loadings of PCBs from Electrical Utility Equipment to MS4s.....	10
3.2.4 Ongoing Release of PCBs from Electrical Utility Equipment	10
3.2.5 Cleanup Methods and Actions Taken in Response to OFEE Releases.....	15
3.3 Potential Causes of Water Quality Problem	16
4.0 SSID Investigation Approach and Schedule	17
4.1 Task 1: Desktop Analysis.....	17
4.2 Task 2: Develop Source Control Framework.....	18
4.3 Task 3: Develop methodologies to account for PCB load reductions from new source control measures.....	19
4.4 Task 3: Develop SSID Project Report	19
4.5 Project Schedule.....	20
5.0 References.....	21

List of Tables

Table 1	Examples of Information Reported on Releases of PCBs to Bay Area Storm Drains and Creeks.	13
Table 2	Tasks, Anticipated Outcomes, and Schedule.	20

List of Figures

Figure 1	<i>Oil-filled electric equipment spills reported to the California Office of Emergency Services (Cal OES) and/or identified through internal Pacific Gas & Electric (PG&E) reports between 1993 and 2017.</i>	11
Figure 2	<i>Total reported gallons of oil released each year (1994 – 2017) from spills from PG&E electrical utility equipment in the Bay Area.</i>	12
Figure 3	<i>PCB Concentration data reported for releases from PG&E electrical equipment between 1993 and 2016.</i>	15

1.0 Introduction

This work plan supports the requirement to implement a Stressor/Source Identification (SSID) Project as required by Provision C.8.e.iii of the San Francisco Bay (Bay) Region Municipal Regional Stormwater National Pollutant Discharge Elimination System (NPDES) Stormwater Permit (MRP) (Order No. R2-2015-0049, SFRWQCB 2015). Per MRP Provision C.8.e.ii, the Bay Area Stormwater Management Agencies Association (BASMAA) Regional Monitoring Coalition (RMC)¹ members are working to initiate eight SSID projects during the five-year term of the MRP (i.e., 2016 – 2020). The RMC programs have agreed that seven SSID projects will be conducted to address local needs (for Santa Clara, Alameda, San Mateo, Contra Costa, Fairfield/Suisun and Vallejo counties), and one project (this project) will be conducted regionally (on behalf of all RMC members). SSID projects follow-up on monitoring conducted in compliance with MRP Provision C.8 (or monitoring conducted through other programs) with results that exceed trigger thresholds identified in the MRP. Trigger thresholds are not necessarily equivalent to Water Quality Objectives (WQOs) established in the San Francisco Bay Basin (Region 2) Water Quality Control Plan (Basin Plan) (SFRWQCB, 2017) by the San Francisco Bay Regional Water Quality Control Board (SF Bay Water Board); however, sites where triggers are exceeded may indicate potential impacts to aquatic life or other beneficial uses.

This SSID work plan describes the steps that will be taken to investigate sources of polychlorinated biphenyls (PCBs) from electrical utility equipment in watersheds draining to the San Francisco Bay Basin. BASMAA will implement the work plan as a regional project. BASMAA retained EOA, Inc., of Oakland, CA to develop this work plan and implement the SSID project under the direction of a BASMAA Project Management Team (PMT). All work on this project is supported by funding provided by BASMAA.

1.1 Overview of SSID Project Requirements

SSID projects focus on taking action(s) to identify and reduce sources of pollutants, alleviate stressors, and address water quality problems. MRP Provision C.8.e.iii requires SSID projects to be conducted in a stepwise process, as described below.

Step 1: Develop a work plan that includes the following elements:

- Define the water quality problem (e.g., magnitude, temporal extent, and geographic extent) to the extent known;
- Describe the SSID project objectives, including the management context within which the results of the investigation will be used;
- Consider the problem within a watershed context and examine multiple types of related indicators, where possible (e.g., basic water quality data and biological assessment results);

¹ The BASMAA RMC is a consortium of San Francisco Bay Area municipal stormwater programs that joined together to coordinate and oversee water quality monitoring and several other requirements of the MRP. Participating BASMAA members include the Alameda Countywide Clean Water Program (ACCWP), Contra Costa Clean Water Program (CCCWP), Fairfield-Suisun Urban Runoff Management Program (FSURMP), San Mateo Countywide Water Pollution Prevention Program (SMCWPPP), Santa Clara Valley Urban Runoff Pollution Prevention Program (SCVURPPP), and City of Vallejo and Vallejo Flood and Wastewater District (formerly Vallejo Sanitation and Flood Control District).

- List potential causes of the problem (e.g., biological stressors, pollutant sources, and physical stressors);
- Establish a schedule for investigating the cause(s) of the trigger stressor/source which begins upon completion of the work plan. Investigations may include evaluation of existing data, desktop analyses of land uses and management actions, and/or collection of new data; and
- Establish the methods and plan for conducting a site-specific study (or non-site specific if the problem is widespread) in a stepwise process to identify and isolate the cause(s) of the trigger stressor/source.

Step 2: Conduct SSID investigations according to the schedule in the work plan and report on the status of the SSID investigation annually in the Urban Creeks Monitoring Report (UCMR) that is submitted to the SF Bay Water Board on March 31 of each year.

Step 3: Follow-up actions:

- If it is determined that discharges to the municipal separate storm sewer system (MS4) contribute to an exceedance of a water quality standard (WQS) or an exceedance of a trigger threshold such that the water body's beneficial uses are not supported, submit a report in the UCMR that describes Best Management Practices (BMPs) that are currently being implemented and additional BMPs that will be implemented to prevent or reduce the discharge of pollutants that are causing or contributing to the exceedance of WQS. The report must include an implementation schedule.
- If it is determined that MS4 discharges are not contributing to an exceedance of a WQS, the SSID project may end. The Executive Officer must concur in writing before an SSID project is determined to be completed.
- If the SSID investigation is inconclusive (e.g., the trigger threshold exceedance is episodic or reasonable investigations do not reveal a stressor/source), the Permittee may request that the Executive Officer consider the SSID project complete.

1.2 SSID Work Plan Organization

This work plan fulfills **Step 1** of the SSID process described above in Section 1.1. It describes the steps that will be conducted to investigate electrical utility equipment as a source of PCBs to the MS4 in watersheds draining to the Bay. The remainder of this work plan is organized according to the required elements described in Step 1:

- Section 2.0 Problem Definition, Study Objectives, and Regulatory Background
- Section 3.0 Study Area, Existing Data, and Potential Causes of Water Quality Problem
- Section 4.0 SSID Investigation Approach and Schedule
- Section 5.0 References

2.0 Problem Definition, Study Objectives, and Regulatory Background

2.1 Problem Definition

Fish tissue monitoring in the Bay has revealed the bioaccumulation of PCBs in Bay sportfish at levels thought to pose a health risk to people consuming these fish. As a result, in 1994, the state of California issued a sport fish consumption advisory cautioning people to limit their consumption of fish caught in the Bay. The advisory led to the Bay being designated as an impaired water body on the Clean Water Act (CWA) "Section 303(d) list" due to elevated levels of PCBs. In response, in 2008, the SF Bay Water Board adopted a Total Maximum Daily Load (TMDL) water quality restoration program targeting PCBs in the Bay². The general goals of the TMDL are to identify sources of PCBs to the Bay, implement actions to control the sources, restore water quality, and protect beneficial uses. The PCBs TMDL estimates baseline loads to the Bay from various source categories. The largest source category, at 20 kilograms (kg) per year, was estimated to be stormwater runoff. This category includes all sources to small tributaries draining to the Bay. The PCBs TMDL indicates that a 90% reduction in PCBs from stormwater runoff to the Bay is needed to achieve water quality standards and restore beneficial uses. The TMDL states that the wasteload allocation for stormwater runoff of 2 kg per year shall be achieved within 20 years (i.e., by March 2030). The PCBs TMDL is being implemented through NPDES permits to discharge stormwater issued to municipalities and industrial facilities in the Bay Area (e.g. the MRP).

This SSID project was triggered by monitoring conducted over the past 15+ years by BASMAA members that demonstrates municipal stormwater runoff is a source of PCBs to the Bay. PCBs are a group of persistent organic pollutants that were historically used in many applications, including electrical utility equipment and caulks and sealants used in building materials. However, the greatest use by far was in electrical equipment such as transformers and capacitors (McKee et al. 2006). Existing electrical utility equipment, which is often located in public rights-of-way (ROWs), may still contain PCBs that can be released to the MS4 when spills and leaks occur. Due to past leaks or spills of PCBs oil from electrical equipment, properties owned and operated by electrical utilities may potentially have elevated concentrations of PCBs in surrounding surface soils that can be released to the MS4. Because the cumulative releases of PCBs-laden soils from these properties, and spills or leaks of PCBs oils from electrical equipment to MS4s across the Bay Area may occur at levels that exceed the 2 kg per year TMDL waste load allocation (see Section 3.2.3), this potential source of PCBs may limit the ability of municipalities to meet the goals of the PCBs TMDL for the Bay. Therefore, this potential source warrants further investigation.

Electrical utility applications present special challenges for source identification and abatement³ due to the quantity of equipment and facilities, their dispersed nature, and difficulty in sampling discharges when they occur. In addition, municipalities lack control over these properties and

² The PCBs TMDL was approved by the US Environmental Protection Agency (USEPA) on March 29, 2010 and became effective on March 1, 2010.

³ Source identification and abatement is one type of stormwater control measure that Permittees use to reduce loads of PCBs in urban runoff. This control measure involves investigations of properties with elevated PCBs in stormwater or sediment to identify sources that contribute a disproportionate amount of PCBs to the MS4, and cause the properties to be abated, or refer the properties to the SF Bay Water Board or other regulatory authority for follow-up investigation and abatement. This control measure is described in more detail in the BASMAA Interim Accounting Methodology for TMDL Loads Reduced (BASMAA 2017).

equipment. Permittees have no jurisdiction over many large electrical utilities and therefore no control over the cleanup of PCBs-containing spills (e.g., dielectric fluids from transformers), or prompt notification when they happen. Release of PCBs from electrical utility applications has proved particularly difficult to document, quantify or control when private utility companies such as Pacific Gas and Electric, (PG&E) are involved. To date, neither Permittees nor the Region 2 Water Board have been able to verify that a sound and transparent cleanup protocol is used consistently by PG&E for PCBs spills from their electrical utility equipment and properties across Bay Area cities. Moreover, current state and federal regulatory levels for reporting and cleanup of PCBs spills (e.g., cleanup goals for soils) are higher than cleanup levels recommended by the SF Bay Water Board to meet the objectives of the PCBs TMDL (SFBRWQCB 2016). These differences create potential missed opportunities to cleanup spills to the more stringent levels that are more consistent with the PCBs TMDL requirements, and for Permittees to report the associated PCBs load reductions via the MRP load reduction tracking and reporting processes.

Due to these constraints, it is not feasible or appropriate for municipalities to develop and implement PCBs control and reporting programs for electrical utility companies. Therefore, municipalities will need to work with the SF Bay Water Board to investigate electrical utility operations. The overall goal of this project is to gather the information needed and provide justification for the SF Bay Water Board to compel the utilities to develop and implement improved procedures and practices that will reduce releases of PCBs to stormwater runoff.

2.2 SSID Project Objectives

The overall goal of this SSID project is to investigate electrical utility equipment as a source of PCBs to urban stormwater runoff and identify appropriate actions and control measures to reduce this source. Building on the information presented by SCVURPPP (2018), this project is designed to achieve the following three objectives:

1. Gather information from Bay Area utility companies to improve estimates of current PCBs loadings to MS4s from electrical utility equipment, and document current actions conducted by utility companies to reduce or prevent release of PCBs from their equipment;
2. Identify opportunities to improve spill response, cleanup protocols, or other programs designed to reduce or prevent releases of PCBs from electrical utility equipment to MS4s;
3. Develop an appropriate mechanism for municipalities to ensure adequate clean-up, reporting and control measure implementation to reduce urban stormwater loadings of PCBs from electrical utility equipment.

A possible outcome of this SSID project is a recommendation that Bay Area municipalities submit a referral to designate electrical utility equipment and properties as a *Categorical Source*, which is a type of source property as described in more detail in the BASMAA Interim Accounting Methodology for TMDL Loads Reduced (BASMAA, 2017). A *Categorical Source* designation would facilitate development of a regional approach to abate this source under the regulatory authority of the SF Bay Water Board. The *Categorical Source* designation was developed specifically to address potential sources of PCBs that are widespread and distributed across multiple jurisdictions, such as electrical utility applications. MRP Permittees, as a group, can refer an entire source category to the SF Bay Water Board. Although local agencies may still identify and refer individual electrical utility properties to the Water Board for abatement, addressing these facilities and equipment as a *Categorical Source* may prove to be a more effective and efficient way to reduce PCBs loads from this source category. The information gained during this project will also provide data that municipalities can use to develop a

methodology to account for PCBs load reductions that can be achieved through implementation of a regional control measure program for electrical utilities.

2.3 Management Questions

This SSID project will address a number of key management questions regarding electrical utility applications as sources of PCBs to MS4s, including:

1. What is the current magnitude and extent of PCBs stormwater loadings from electrical utility equipment and operations in the San Francisco Bay Area region?
2. What aspects of equipment or operational procedures should electrical utilities be required to report to the SF Bay Water Board?
3. Are improvements to spill and cleanup control measures needed to reduce water quality impacts from the release of PCBs in electrical utility equipment?
4. Are additional proactive management practices needed to reduce releases of PCBs from electrical utility equipment?
5. What are the PCBs load reductions that can be achieved through implementation of a regional reporting and control measure program?

2.4 Regulatory Context of PCBs WQOs

To better understand the issues of PCBs in the Bay, it is important to understand the regulatory context of the PCBs WQOs and human health risks associated with PCBs. The State Water Resources Control Board (SWRCB) is part of the California Environmental Protection Agency and administers water rights, water pollution control, and water quality functions for the state. It shares authority for implementation of the federal CWA and the state Porter-Cologne Act with the nine Regional Water Quality Control Boards. The Regional Water Boards regulate surface water and groundwater quality through development and enforcement of WQOs and implementation of Basin Plans that will protect the beneficial uses of the State's waters. These plans designate beneficial uses, WQOs that ensure the protection of those uses, and programs of implementation to achieve the WQOs.

The Basin Plan for the San Francisco Bay region (SFRWQCB 2017) provides the basis for water quality regulation in the San Francisco Bay region. It is implemented by the SWRCB and the SF Bay Water Board. The Basin Plan identifies beneficial uses of Bay waters, establishes narrative and numerical WQOs protective of those beneficial uses, identifies areas where discharges are prohibited, and sets forth a program of implementation to ensure that the Bay WQOs are achieved and beneficial uses are protected. Several beneficial uses are designated in the San Francisco Bay region including commercial and sport fishing (COMM), defined in the Basin Plan as:

- **COMM:** *“Uses of water for commercial or recreational collection of fish, shellfish, or other organisms, including, but not limited to, uses involving organisms intended for human consumption or bait purposes.”*

To protect this beneficial use, the narrative WQO for PCBs in the Bay states that “controllable water quality factors shall not cause a detrimental increase in toxic substances found in bottom sediments or aquatic life”. PCBs in Bay sportfish have been found at levels thought to pose a health risk to people consuming these fish. As a result, the COMM beneficial use of the Bay is not currently supported and the narrative WQO for PCBs has not been achieved.

3.0 Study Area, Existing Data, and Potential Causes of Water Quality Problem

3.1 Study Area

The study area for this SSID project is the portion of the San Francisco Bay Area region subject to the MRP. This section provides an overview of electrical utility systems and companies currently operating in the study area, and describes how and where PCBs are used within those systems.

Electrical utilities produce or buy electricity from generating sources, and then distribute that electricity to users through two networks: the transmission system and the distribution system. The **transmission system** carries bulk electricity at high voltages, often across long distances, directly from generation sources to substations via high voltage power lines. Substations connect the transmission and distribution systems. Substations may increase the voltage from nearby generating facilities for more efficient transmission over long distances or lower the voltage for transfer to the distribution system. Electricity at a typical substation flows from incoming transmission lines, to circuit breakers, to transformers (which step down the voltage), to voltage regulators and cut out switches (which protect the system from overvoltage), and finally to outgoing distribution lines.

The **distribution system** delivers lower voltage electricity from substations directly to homes and businesses over shorter distances. This system includes pole-mounted equipment, equipment in underground vaults, and aboveground equipment on cement pads that are often in green boxes in the public right-of-way (ROW). This equipment is smaller, but more numerous in terms of the number of units.

Electrical utility equipment and facilities in both the transmission and distribution systems are distributed across the entire Bay Area region. In the past, PCBs were routinely used in electrical utility equipment that contained dielectric fluid as an insulator. This is because prior to the 1979 PCBs ban, dielectric fluid was typically formulated with PCBs due to a number of desirable properties they have (e.g., high dielectric strength, thermal stability, chemical inertness, and non-flammability). Electrical equipment containing dielectric fluid is typically identified as Oil-Filled Electrical Equipment (OFEE). Any OFEE that contained PCBs in the past could still potentially be in use and contain PCBs today. The most common types of OFEE that may contain PCBs are transformers, capacitors, circuit breakers, reclosers, switches in vaults, substation insulators, voltage regulators, load tap changers, and synchronous condensers (PG&E 2000).

In the Bay Area, there are eight electric utility companies operating as of February 2015 (State Energy Commission 2015):

Investor-Owned Utilities (IOUs)

1. Pacific Gas and Electric Company (PG&E)
77 Beale Street
San Francisco, CA 94105
(415) 973-7000 (tel)

Publicly Owned Load Serving Entities (LSEs) and Publicly Owned Utilities (POUs)

2. Alameda Municipal Power
2000 Grand Street
Alameda, CA 94501-0263
510.748.3905 (tel)
3. CCSF (also called the Power Enterprise of the San Francisco Public Utilities Commission)
1155 Market Street, 4th Floor
San Francisco, CA 94103
209.989.2063 (tel)
4. City of Palo Alto, Utilities Department
P.O. Box 10250
Palo Alto, CA 94303
650.329.2161 (tel)
5. Pittsburg Power Company Island Energy-City of Pittsburg,
65 Civic Drive
Pittsburg, CA 94565-3814
925.252.4180 (tel)
6. Port of Oakland
530 Water Street, Ste 3
Oakland, CA 94607-3814
510.627.1100 (tel)
7. Silicon Valley Power (SVP) - City of Santa Clara
1500 Warburton Avenue
Santa Clara, CA 95050
408.615.2300 (tel)

Community Choice Aggregators

8. Marin Clean Energy (MCE)
781 Lincoln Ave Ste 320
San Rafael, CA 94901-3379
888.632.3674 (tel)

PG&E is by far the largest electrical utility company in the Bay Area. PG&E is an investor-owned company that is not under the jurisdiction of any Bay Area municipality⁴. Three small publicly-owned utilities in the Bay Area (Alameda Municipal Power, City of Palo Alto Utilities Department, and Silicon Valley Power owned by the City of Santa Clara) maintain their own substations and distribution lines. The other public utilities partner with PG&E to deliver energy through PG&E's equipment. PG&E owns and operates several hundred electrical substations in the Bay Area, in addition to the smaller electrical utility equipment that is widely disbursed throughout urbanized areas and along rural corridors (e.g., small transformers on utility poles or in utility boxes). The total number of pieces of equipment that is in use across the Bay Area and that contains PCBs is not known but is likely in the range of tens to hundreds of thousands (see Section 3.2.2).

⁴ PG&E is regulated by the California Public Utilities Commission (CPUC) and the Federal Energy Regulatory Commission (FERC).

3.2 Existing Data

This section presents an overview of the current state of knowledge about PCBs used by electrical utility companies in the Bay Area, the potential mass of PCBs released into the environment from this source over the past 50+ years, and the regulatory programs currently available for the purposes of managing PCBs and reporting and cleaning up spills. This information focuses on PG&E because this private company owns and operates the vast majority of electrical utility properties and equipment in the Bay Area. This information was originally reported by SCVURPPP (2018).

3.2.1 Regulatory Controls on PCBs in Electrical Utility Equipment

Existing federal and state regulations are primarily focused on controlling the management and handling of in-use PCBs and PCB-containing equipment when the concentrations are above the thresholds for hazardous waste. Under federal regulations, the hazardous waste threshold for PCBs is ≥ 50 parts per million (ppm). Under California regulations, the hazardous waste threshold for PCBs is ≥ 5 ppm in liquids (using the Waste Extraction Test, WET), and ≥ 50 ppm in solids. The allowable post-cleanup concentrations of remaining soils and other surface materials typically range from 10 to 25 ppm, depending on site-specific evaluations of human health risk. As a result, current efforts to control and cleanup PCB releases from electrical utility equipment are focused on these thresholds.

By comparison, Bay Area municipalities are concerned with much lower concentrations of PCBs. For example, currently Bay Area municipalities generally designate a site as a *potential* PCBs source to stormwater runoff if soil or sediment concentrations are ≥ 0.5 ppm and designate a site as a *confirmed* PCBs source to stormwater runoff if soil or sediment concentrations are ≥ 1.0 ppm. Control of PCBs sources at these substantially lower concentrations has been deemed necessary to make progress towards meeting the stringent stormwater runoff wasteload allocations called for in the PCBs TMDL.

3.2.2 PCBs Remaining in Electrical Utility Equipment

Although use of PCBs is highly restricted currently, McKee et al. (2006) estimated that 12.3 million kilograms of PCBs were used in the San Francisco Bay Area between 1950 and 1990. Roughly 65% (8 million kg) was used in electrical transformers and large capacitors (McKee et al. 2006). How much of this mass was released to the environment and how much remains in electrical equipment distributed across the Bay Area today is unknown. While the 1979 ban of PCBs did not require the immediate removal of PCBs from current applications, electrical utilities have made substantial efforts over the past 35+ years to reduce the amount of PCBs still used in their applications in the Bay Area. According to PG&E, the majority of OFEE containing PCBs in the Bay Area has already been removed or refurbished with dielectric fluids that do not contain PCBs through the following actions:

- Voluntary replacement programs;
- Ongoing removal of PCBs from OFEE as units are serviced or replaced due to routine maintenance programs; and
- OFEE replacement due to unplanned actions (e.g., transformer leaks and fires).

Voluntary actions conducted by PG&E, primarily in the mid-1980s, included the PCBs Distribution Capacitor Replacement Program and the PCBs Network Transformer Replacement Program (PG&E 2000). In addition, in the 1990s, PG&E implemented a program to remove oil-filled circuit breakers and replace them with equipment that contains sulfur hexafluoride gas

(PG&E 2000). Current ongoing PG&E efforts to remove PCBs-containing equipment are conducted primarily through maintenance programs. Past maintenance of older equipment may have included draining PCBs-containing oils and refilling the equipment with oils that did not contain PCBs. These refurbished OFEE may still contain PCBs at levels of concern to municipalities due to residual contamination from the original PCB-oil. Currently, as maintenance staff identify older equipment in-use, it is scheduled for replacement. However, PG&E has provided limited documentation of their past and current PCBs removal efforts. There remains much uncertainty on where PCBs transformers, PCBs capacitors, oil-filled circuit breakers, and PCBs-containing distribution system equipment were originally located, and which ones have already been removed or replaced.

Despite the removal efforts described above, PCBs may still be found in older and refurbished OFEE, and particularly OFEE located throughout the distribution system. In a recent meeting with SF Bay Water Board Staff, PG&E noted that any equipment installed prior to 1985 could contain PCBs, as it would have come from equipment stockpiled prior to the 1979 ban and was installed prior to the voluntary replacement programs (*personal communication*, Sanchez 2016). Because OFEE are not typically tested for PCBs until the fluid is removed during servicing or disposal, or in the event of a spill, the total number of PCBs-containing OFEE that remain in use is unknown. However, in a letter to the SF Bay Water Board in 2000, PG&E provided information that can be used to make some preliminary estimates, including the following (PG&E 2000):

- There are over 900,000 pieces of OFEE in service in the distribution system;
- In 1999, 22,000 pieces of equipment were serviced at the main PCBs-handling facilities in Emeryville;
- Approximately 10 percent of the units serviced and tested annually contain PCBs at concentrations of 50 parts per million (ppm) or greater, and fewer than 1 percent contained PCBs at concentrations of 500 ppm or greater; and
- The number of pieces of equipment containing PCBs concentrations > 50 ppm has declined over time.

The information above was used to calculate the following:

- Assuming the count of equipment processed in 1999 in Emeryville represents an average annual processing rate throughout the region and that there are at least 900,000 pieces of equipment in PG&E's distribution system it would take over 40 years at a minimum for all of this equipment to be replaced;
- Assuming the 1999 processing rate and 900,000 pieces of equipment in the distribution system in 1985, approximately 175,000 pieces would not yet have been serviced or replaced as of 2018; and
- Of the approximately 175,000 pieces of equipment remaining in-use in 2018, approximately 17,500 (10%) may contain PCBs concentrations > 50 ppm.

Although based on limited information, the above estimates demonstrate that a potentially large number of pieces of equipment containing PCBs over 50 ppm (i.e., 17,500 as of 2018) may remain in-use in the electrical utility distribution system. And the remaining 90% (roughly 157,000 pieces of equipment) may contain lower concentrations of PCBs that could still be of concern to Permittees in their efforts to meet TMDL requirements.

3.2.3 Estimated Loadings of PCBs from Electrical Utility Equipment to MS4s

Building upon their estimates of the total mass of PCBs used historically in the Bay Area, McKee et al. (2006) developed a transport and fate conceptual model that identified the major sources of PCBs to stormwater conveyances and described mass movement from these sources or source areas into the stormwater conveyance system. McKee et al. (2006) estimated the net mass input of PCBs to MS4s in the Bay Area in 2005 was approximately 28 kg per year.⁵ Of this total, roughly 29% (8 kg/yr) was estimated to have originated from controlled closed systems (transformers and large capacitors) and 71% (20 kg/yr) was from dissipative uses (e.g., release of PCBs-containing building materials such as caulks and sealants during demolition and renovation). This includes both current and legacy uses that resulted in widespread distribution of PCBs across watershed surfaces. In other words, these estimates suggest that because of both current and past use, transformers and large capacitors, which are both electrical utility applications, may continue to contribute nearly one-third of the net PCBs mass to MS4s in the Bay Area. As noted earlier, such loadings would exceed the 2 kg per year TMDL waste load allocation for stormwater runoff (see Section 2.3.2) and limit the ability of municipalities to meet the goals of the PCBs TMDL for the Bay. Conversely, reduction of PCBs released to MS4s from electrical utility equipment may support attainment of TMDL goals.

3.2.4 Ongoing Release of PCBs from Electrical Utility Equipment

Although the bulk of PCBs remain contained within OFEE until the equipment is removed from use and transported to proper hazardous waste disposal facilities, releases of PCBs to the environment can and do occur. In order to document current spills, publicly available data in the California Office of Emergency Services (Cal OES) spill report database (Cal OES 2016), as well as internal spill records (PG&E 2000) supplied by PG&E to the SF Bay Water Board in September 2000 (that were provided pursuant to a California Water Code §13267 request for information) were reviewed. The Cal OES database and available PG&E spill records were searched for reports of spill releases related to OFEE in the Bay Area between 1994 and 2017. Over 1,200⁶ reported release incidents from PG&E OFEE in the Bay Area were identified. The information provided by these records and a summary of the important issues identified for water quality concerns are summarized in the remainder of this section. It is important to note that current regulations do not require reporting of all releases from OFEE. The information provided below is based only on the reported releases for which records were available, and likely represents an underestimate of actual OFEE releases during the time period of review. However, these reports clearly demonstrate that PCBs may still be present in the electrical transmission and distribution systems in the Bay Area, and that releases from these systems can and do continue to occur.

Generally, the publicly available spill release records provide information about the spill release date, time, location, chemical, quantity released, actions taken, known or anticipated risks posed by the release, and additional comments. Other information that is sometimes reported for OFEE releases includes a description of the causes of the release and the equipment affected, and the concentrations of PCBs in that equipment (if known). Concentration information reported is likely assumed from equipment labels, as ranges are most often provided rather than specific values. Typically, the reports are limited to the information that was

⁵ The PCBs TMDL estimates a PCBs loading of 20 kg per year from stormwater runoff (see Section 2.1).

⁶ The records span 24 years of spill reports, and include PG&E's own record of releases from 1994 thru 1999 and a portion of 2000. The number of reports PG&E submitted in 2000 represents less than half the number of reports for that year. Records did not include all the districts in the Bay Area. District documents submitted reported releases prior to June of 2000, with the exception of one district that submitted a June report. As a result, the number of additional reports from PG&E's records are assumed to be less than half the number of incidents for 2000.

available at the time the spill was initially reported. In some cases, follow-up information such as the results of analytical testing of the spilled materials is also provided, but this is not typical.

3.2.4.1 Number of Reported OFEE Releases

Between 1994 and 2017, over 1,000 spills from PG&E electrical equipment were reported to Cal OES. PG&E records contain information about 200 additional releases that were not reported to Cal OES between 1994 and 2000. A count of these reports by year is presented in Figure 1.

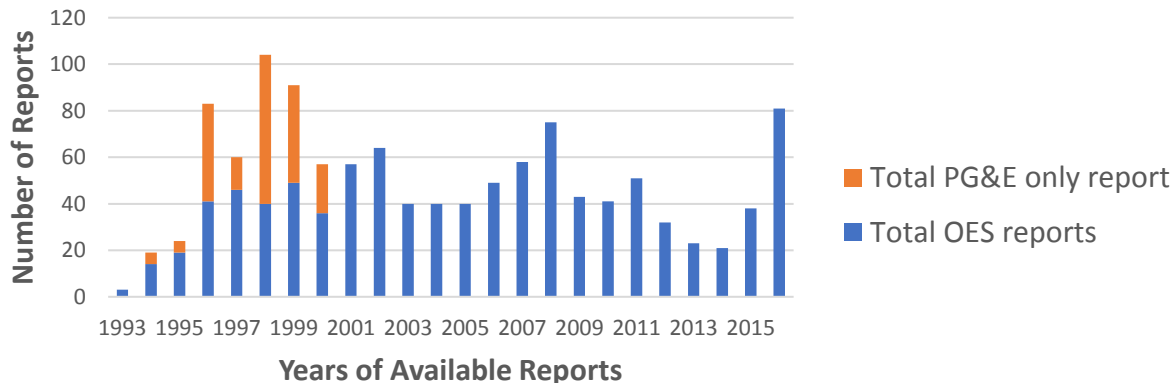

Figure 1. Oil-filled electric equipment spills reported to the California Office of Emergency Services (Cal OES) and/or identified through internal Pacific Gas & Electric (PG&E) reports between 1993 and 2017.

3.2.4.2 Volume of OFEE Releases

The total volume of material released from all reported OFEE spills in a given year in the Bay Area is presented in Figure 2. Mineral oil or transformer oil are the substances identified in over 99% of reported releases from OFEE in the Cal OES spill report database. In a phone conference with SF Bay Water Board staff in 2012, PG&E said they submit written reports to Cal OES for all PCBs spills that meet or exceed the mineral oil federal reportable quantities (RQ) of 42 gallons (*personal communication*, Jan O’Hara 2012). However, the reports reviewed indicate written reports are sometimes submitted for spills that are much less than 42 gallons.

The reported volumes of oil released during a single incident range from less than one gallon up to 5,000 gallons. Nearly half of all OFEE spill reports identify the volume of oil spilled as 5 gallons or less, and more than 90% of all spill reports identify the volume of fluid spilled as less than 100 gallons. Releases as large as 500 gallons from the distribution system and 5,000 gallons from the transmission system have been reported. Only five incidents reported releases that exceeded 1,000 gallons of oil. Nearly all (~99%) of reports provided information on the volume of oil released.

The reported volumes released do not necessarily equate to the volume of the oil that may have reached storm drains or local creeks. Estimates of those volumes were not available.

3.2.4.3 Location of OFEE Releases

Cal OES and PG&E records show releases occurred in all Bay Area counties. Leaks and spills of PCBs from electrical equipment have occurred onto roads, sidewalks, pervious areas, vegetation, structures, vehicles, and even people (Cal OES 2016). Most releases occurred in

the distribution system, often from equipment installed in public ROWs such as pole-mounted transformers installed along roadways.

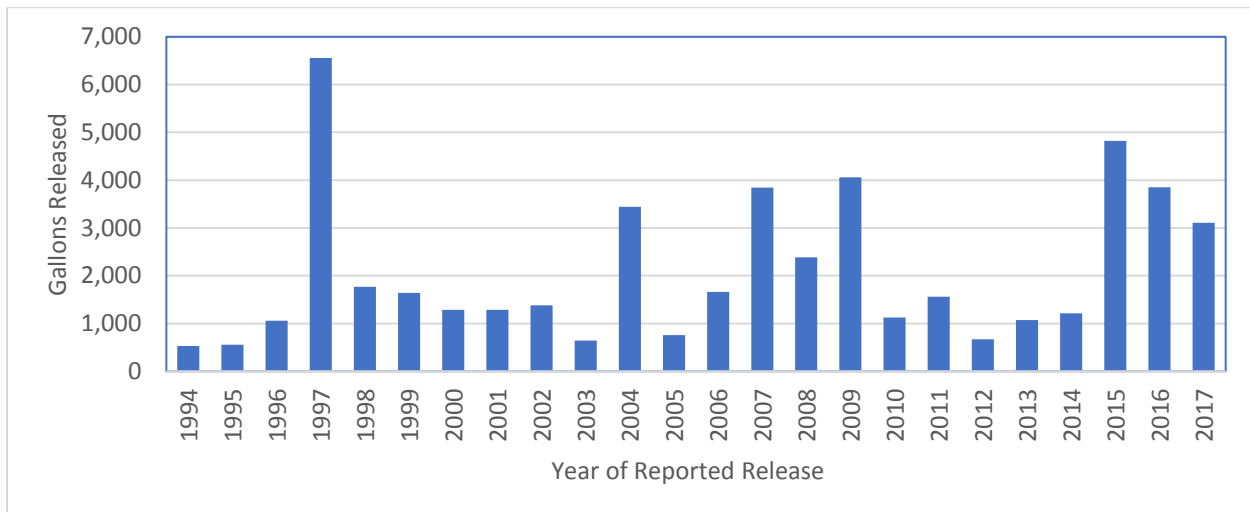

Figure 2. Total reported gallons of oil released each year (1994 – 2017) from spills from PG&E electrical utility equipment in the Bay Area.

A number of reports document direct releases from OFEE to the MS4, and potentially a downstream waterbody (e.g., creek). There are at least 17 incidents identified during the past 15 years that involved direct releases from PG&E OFEE directly to a waterbody or to storm drains that discharge to local creeks (Table 1). The majority of these releases were reported as having unknown PCBs concentrations, and no reports provide any follow-up information on the concentration of PCBs in the spilled materials based on chemical analysis.

It is important to note that in addition to the incidents identified in Table 1, materials spilled during any of the numerous other incidents may (or may not) have entered the MS4 and/or receiving waters such as local creeks directly or been washed into the MS4 and/or creeks by stormwater or irrigation runoff. Generally, the spill reports lack any details regarding this type of information.

Table 1. Examples of Information Reported on Releases of PCBs to Bay Area Storm Drains and Creeks.

Date	Gallons	Reported Concentration	Water Body	Municipality
1/24/2016	Unknown	<50 ppm	Coyote Creek	San José
2/17/2016	Up to 18	Unknown	Los Gatos Creek	Los Gatos
3/7/2016	10	Unknown	Culvert	Concord
8/16/2016	Unknown	<50 ppm	Guadalupe River	San José
11/17/2015	Unknown	Unknown	Cerrito Creek	Richmond
10/4/2015	5	Unknown	Creek	Los Gatos
5/3/2015	30	<2 ppm	Cerrito Creek	Richmond
3/2/2011	30	Unknown	Unknown Marsh	Menlo Park
6/2/2007	40	Unknown	Pond, Marsh Area	Vallejo
2/28/2006	20	<50 ppm	Calara Creek	Pacifica
5/27/2006	1	Unknown	Unknown Creek	Orinda
10/10/2005	Unknown	Unknown	Coyote Creek	San José
7/23/2005	<15	Unknown	Nearby Creek	Walnut Creek
12/8/2004	Small amount	<50 ppm	Moraga Creek	Orinda
3/7/2004	Unknown	Unknown	Blossom Creek	Calistoga
7/14/2003	8	< 50 ppm	Coyote Creek	San José
2/16/2002	15	Unknown	Napa River	Napa

3.2.4.4 Causes of OFEE Releases

Cal OES release reports and PG&E records document a number of causes of PCBs releases from OFEE. Most releases can be attributed to one of the following:

- Equipment Failure.** This is the cause of the majority of the reported releases. Equipment failure in utility vaults has additional potential as an important source of PCBs because OFEE in these vaults may contain more than 100 gallons of oil. More than 50 release incidents were reported for equipment contained in electrical utility vaults during the time period reviewed. A number of these reports noted the presence of water in the vaults in addition to the PCBs oil released. Releases from equipment failure in utility vaults are mostly contained, but Cal OES spill reports document releases of PCBs oil that breached containment, including discharges that reached water bodies.

- **Accidents.** Approximately 20% of reported releases resulted from equipment knocked over by accident. In the distribution system, reports document 50 to 500 gallons released from poles knocked over during car accidents, by construction equipment, and during tree trimming. On rare occasion PCBs releases have occurred during accidents while equipment is in transport.
- **Storms, Fires, and Overheating from High Summer Temperatures.** These factors are the reported cause of more than 10% of the releases from the distribution system.
- **Field Repairs and Fluid Replacement.** The Cal OES database contains records that indicate draining fluids in the field may have been ongoing as recently as 2007, when a report documented that a valve left open from draining a transformer in the field caused a release. In 2016, Daniel Sanchez, who at the time was PG&E's Manager of Hazardous Materials and Water Quality Environmental Management Programs, informed SF Bay Water Board staff that PG&E does not drain and refill pole mounted PCB transformers in the field any longer; however, it is unclear when this practice ceased, and/or if it still occurs with equipment not mounted on poles.
- **Vandalism.** Between 1997 and 2015, there were at least 25 separate reported incidents of vandalism that resulted in PCBs releases. For example:
 - In 1997, gunshot damage caused the release of 5,000 gallons of oil from a substation transformer and regulators in San Mateo County;
 - In 2011, copper theft at a substation released 750 gallons of oil in Contra Costa County;
 - In 2013, vandalism of pad-mounted transformers resulted in the release of possibly 1,000s of gallons of oil before discovery in San José.

3.2.4.5 PCBs Concentrations in OFEE Releases

Of the more than 1,200 spill reports that were reviewed, approximately one-third identified the PCBs concentration as unknown or did not provide any information on the PCBs concentration of the spilled material (Figure 3). Releases with high PCBs concentrations (> 500 ppm) were infrequently reported, accounting for only 1% of reported spills. Concentrations above 50 ppm represent about 8% of the reported spills. As recently as 2016, failure of a PG&E pole-mounted transformer resulted in release of mineral oil with 280 ppm PCBs to surrounding soils and brick structures. For approximately 44% of the reported releases, the PCBs concentration was identified as less than 50 ppm, based primarily on assumptions associated with a "Non-PCB" label. According to labeling requirements, a "Non-PCB" label indicates the PCBs concentrations in the oil are assumed to be below hazardous waste thresholds of 50 ppm (federal regulations, see Section 3.2.1). However, in most cases, no additional information was provided in the spill reports to indicate how the "Non-PCB" category was arrived at, or whether the federal (> 50 ppm) or state (> 5 ppm in liquid) "Non-PCB" category was assumed. For the vast majority of these reports, no follow-up chemical analysis results were provided that confirmed the "Non-PCB" designations. In a limited number of reports, follow-up PCBs analysis results were provided for materials that were identified as "Non-PCB" during initial reporting. Generally, these results found PCBs concentrations between 5 and 49 ppm, suggesting that the labels were correctly applied. However, any concentration of PCBs in electrical equipment oils is potentially significant in terms of water quality impacts and implementation of the PCBs TMDL. These results clearly demonstrate that the "Non-PCB" designation represents a threshold that is far too high to necessarily be protective of water quality.

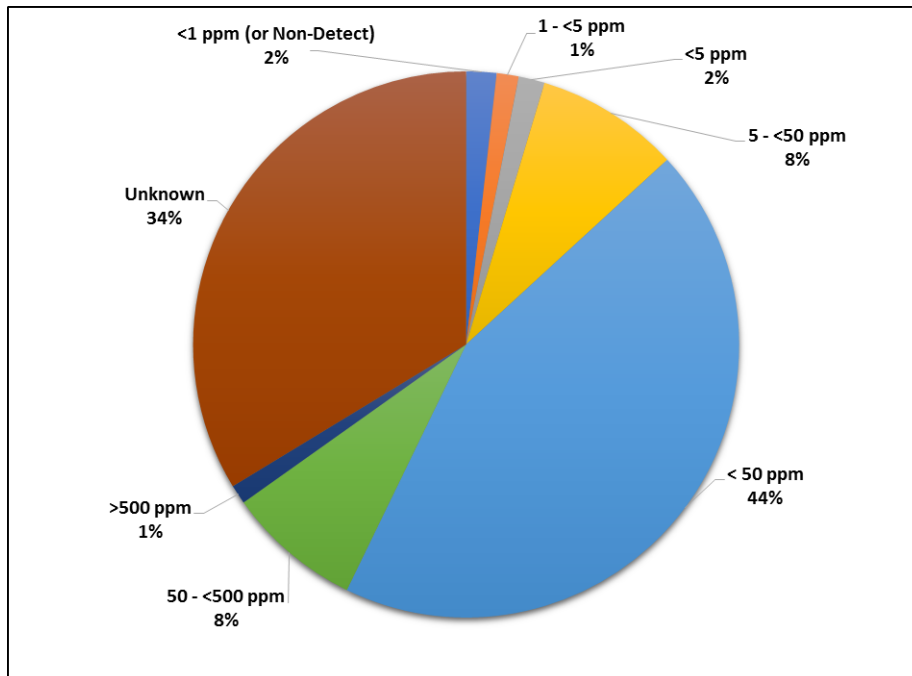

Figure 3. PCB Concentration data reported for releases from PG&E electrical equipment between 1993 and 2016.

Only 1% of the reported releases identified the PCBs concentrations as either below 1 ppm, or below detection limits. Although the quality of the PCBs concentration data in the release reports varies widely, these results clearly demonstrate that PG&E's electrical equipment in the Bay Area can still contain PCBs at concentrations of concern for water quality protection programs.

3.2.5 Cleanup Methods and Actions Taken in Response to OFEE Releases

Limited information is available on the spill response protocols used by electrical utility companies during cleanups. Based on information publicly available, electrical utility companies typically address spills or leaks from their equipment with Standard Operating Procedures (SOPs) that should conform to both State and Federal requirements. According to information provided to the SF Bay Water Board (PG&E 2000), PG&E spill response is guided by internal documents, including:

- **Utility Operations Standard D-2320** - for PCBs spills in the distribution system;
- **PCB Management at Substations** - for PCBs spills in the transmission system.

However, these documents are not publicly available for review.

The Cal OES reports provide almost no information on actions taken to stop active spills, or the methods used to cleanup spilled materials from surrounding surfaces, storm drain infrastructure, or creeks. Municipalities need this type of information to better understand any potential risks that remain following initial cleanup. Because of the challenges with achieving the stormwater runoff wasteload allocation in the PCBs TMDL, additional remedial actions may be warranted in some cases.

3.3 Potential Causes of Water Quality Problem

Given the history of PCBs use in electrical utility equipment, the current estimates of electrical equipment still in use that contain PCBs, and existing documentation that spills of PCBs from electrical utility equipment continue to occur, electrical utility equipment is likely a significant source of PCBs to stormwater runoff, and ultimately to the Bay. PG&E, the largest electric utility company in the Bay Area, was likely the largest single user of PCBs in the Bay Area, and as such, likely remains the largest current source of PCBs releases to MS4s from electrical utility equipment.

4.0 SSID Investigation Approach and Schedule

The overall approach for this SSID Investigation is to (1) conduct a desktop analysis and (2) propose a source control framework for electrical utility equipment to reduce ongoing PCBs loads to the Bay in stormwater runoff. The purpose of the desktop analysis is to better understand the extent and magnitude of electrical utility equipment as a source of PCBs to urban stormwater runoff, document past and current efforts to reduce PCBs releases from electrical utility equipment during spills or other accidental releases, and document measures already taken or underway to remove PCBs-containing oils and electrical equipment from active service across the Bay Area. The results of the desktop analysis will inform identifying new or improved control measures to avoid/reduce the release of PCBs from this source. This information may also be used to update the estimated PCBs loads to stormwater from this source, and inform development of a load reduction accounting methodology. This project will request the assistance and support of the SF Bay Water Board to gather the information needed from electrical utility companies to conduct the desktop analysis. Based on the outcomes of the desktop analysis, this project will then propose a framework for addressing PCBs from electrical utility equipment. The framework may include a recommendation to designate electrical utilities as a *Categorical Source* of PCBs to stormwater in order to facilitate the development of a comprehensive, regional control measure program to address this source.

This SSID Project is a BASMAA Regional Project. The BASMAA Monitoring and Pollutants of Concern Committee (BASMAA MPC) will oversee implementation of the project. Implementation of this work plan will contribute to fulfillment of MRP Provision C.8.e requirements for all BASMAA co-permittees.

4.1 Task 1: Desktop Analysis

The desktop analysis is designed to gather and evaluate information on electrical utility equipment in the Bay Area to determine if a *Categorical Source* referral is warranted, and to provide the foundation for development of a comprehensive regional control measure program to reduce PCBs loads from this source. The desktop analysis will include the following five sub-tasks:

- **Subtask 1.1 Request information from electrical utility companies.**

This task will seek the assistance and support of the SF Bay Water Board to: obtain information from private utility companies that is not publicly available but is needed to better understand the extent and magnitude of PCBs releases from OFEE; identify the most appropriate actions to prevent or reduce releases from this source; and develop and implement effective reporting and control measures. For this task, the SF Bay Water Board will be asked to assist BASMAA in compelling electrical utility companies (e.g., PG&E) to provide the necessary information. A preliminary list of information that will be requested includes the following:

 - Spill reporting and notification procedures (both company-wide and location-specific);
 - Spill records NOT reported in Cal OES;
 - SOPs and other documentation used by electrical utilities and their contractors to guide spill response and cleanup actions when releases from OFEE occur;
 - SOPs and documentation, including analytical methods for PCBs used by electrical utilities and their contractors to identify and clean up regular leaks from OFEE during regular maintenance activities

- Measurement data on concentrations of PCBs in OFEE;
- Maintenance records that document when and where PCBs-containing OFEE are removed from the system and how often PCBs containing equipment is inspected for leaks or spills;
- Documentation of past programs to voluntarily remove PCBs-containing oils or OFEE – including what equipment was removed, and the locations from which it was removed; and
- Documentation of where PCBs-containing OFEE were located in the past, and where they are currently located across the Bay Area.

This list will be reviewed prior to making any data requests. Additional data gaps may also be identified and added to the data request based on discussions with SF Bay Water Board staff and/or preliminary information provided by utility companies.

- **Subtask 1.2 Assess current electrical utility data.**

This task will review, tabulate and analyze the information provided by electrical utility companies as a result of the SF Bay Water Board's request for information, in order to document the following:

- Measurement data on PCBs concentrations and/or mass in OFEE;
- Locations of PCBs-containing OFEE;
- Quantity of PCBs-containing OFEE removed from service annually;
- Occurrences of spills or releases from OFEE;
- Current PCBs spill and cleanup reporting requirements; and
- Current PCBs cleanup protocols.

- **Subtask 1.3 Improve estimates of PCBs loadings.**

This task will combine the information provided in Subtask 1.2 with all existing data in order to develop improved estimates of current PCBs loadings from electrical utility equipment to MS4s in the study area. The quality of these estimates will partly depend on the quality of the data received from the utility companies.

- **Subtask 1.4 Refine PCBs reporting requirements**

This task will review all current reporting and notification requirements to identify any improvements or clarifications that the SF Bay Water Board could require of electrical utilities to provide the type of data needed to better quantify the amount of PCBs released from OFEE spills, and to help ensure that adequate cleanup actions are being implemented.

- **Subtask 1.5 Evaluate PCBs cleanup protocols**

This task will review all documented cleanup protocols that are currently used by electrical utility companies in order to identify any changes or improvements that could be recommended to further reduce the discharge of PCBs to the MS4 when releases occur.

4.2 Task 2: Develop Source Control Framework

Based on the results of the desktop analysis, this task will propose an appropriate framework for managing and implementing control measures to reduce PCBs from electrical utility equipment. The framework should include prescribed methods and procedures for unplanned spills and

releases from OFEE, as well as a plan for continued reduction of PCBs from in-use OFEE, and potentially further identification and cleanup of historic release sites. The framework will likely include the following elements:

- Summary of the outcomes of the desktop analysis results, including:
 - a. Summary of information provided by electrical utility companies as a result of the SF Bay Water Board's request for information from electrical utilities;
 - b. Improved estimates of current PCBs loadings from electrical utility equipment based on information received;
 - c. Documentation of current spill clean-up and reporting actions, and existing programs for proactive removal of PCBs-containing oils and equipment conducted by electrical utility companies;
 - d. Recommended PCBs spill and cleanup reporting requirements that the SF Bay Water Board could require of electrical utilities;
 - e. Recommended improvements to PCBs spill cleanup protocol(s) that would reduce the discharge of PCBs to MS4s that the SF Bay Water Board could require of electrical utilities.
- A recommendation (based on the results of the Task 1 desktop analysis) about designation of electrical utility equipment as a *Categorical Source*.
- Recommended approach to manage and control releases of PCBs from electrical utility companies. For example, if a *Categorical Source* referral is submitted, the recommended approach will focus on development of a comprehensive regional control measure program. The program would include requirements the SF Bay Water Board could impose on electrical utility companies in the Bay Area, such as new spill reporting and cleanup protocols.

4.3 Task 3: Develop methodologies to account for PCB load reductions from new source control measures

BASMAA will further apply the results of the desktop analysis to develop methodologies to account for the PCBs load reductions that can be achieved via the new clean-up and reporting protocols identified above in Task 2.

4.4 Task 3: Develop SSID Project Report

BASMAA will prepare a report describing the desktop analysis and outcomes. The report will summarize the information provided by electrical utility companies and identify recommendations to modify or improve current control measures or management actions that will reduce PCBs released to MS4s. The Management Questions described in Section 2.3 will be addressed:

1. What is the current magnitude and extent of PCBs stormwater loadings from electrical utility equipment and operations in the San Francisco Bay Area region?
2. Are there aspects of equipment or operational procedures that electrical utilities should be required to report to the SF Bay Water Board?
3. Are there additional spill and clean-up controls needed to reduce water quality impacts from the release of PCBs in electrical utility equipment?

4. Are there additional proactive activities needed to avoid releases of PCBs from electrical utility equipment?
5. What are the PCBs load reductions that can be achieved through implementation of a regional reporting and control measure program?

4.5 Project Schedule

Table 2 summarizes the tasks and anticipated outcomes described in this work plan, and the proposed schedule for each task. This is an approximately one-year effort to be conducted primarily in Fiscal Year 2019-2020. However, Task 1 (information request) will likely be made before the end of Fiscal Year 2018-2019. It is anticipated that the SSID project report will be completed in June 2020. The schedule in Table 2 is dependent upon the timing, extent, and format of the data that are received from electrical utility companies based on the SF Bay Water Board's request for information.

Table 2. Tasks, Anticipated Outcomes, and Schedule.

Task Description		Anticipated Outcome(s)	Anticipated Completion Date
Task 1: Desktop Analysis			
1.1	Request information from electrical utility companies	Language for information request provided to SF Bay Water Board.	Apr-2019
1.2	Assess current electrical utility data	Summary tables of information and analyses of the data received from electrical utility companies.	Oct-2019
1.3	Improve estimates of PCBs loadings	Tables with estimated annual PCBs loads to MS4s from electrical utility equipment.	Nov-2019
1.4	Refine PCBs reporting requirements	Recommended improved PCBs spill and cleanup reporting requirements for electrical utility companies.	Dec-2019
1.5	Evaluate PCBs clean-up protocols	Recommended improved PCBs cleanup protocols for electrical utilities companies.	Dec-2019
Task 2: Develop Source Control Framework		Recommended source control framework for electrical utility equipment.	Jan-2020
Task 3: Develop PCBs Load Reduction Accounting Methodology		Recommended methodology to account for PCBs load reductions achieved through implementation of new source controls.	Jan-2020
Task 4: Reporting		Regional SSID Project Report	Jun-2020

5.0 References

Bay Area Stormwater Management Agencies Association (BASMAA) 2017. Interim Accounting Methodology for TMDL Loads Reduced. Prepared by Geosyntec Consultants and EOA, Inc. March 2017.

Cal OES 2016. Hazardous Materials Spill Release Reporting Archive 1993-2016 review. Governor's Office of Emergency Services, Sacramento, CA. <http://www.caloes.ca.gov/cal-oes-divisions/fire-rescue/hazardous-materials/spill-release-reporting> Date?

McKee, L., Mangarella, P., Williamson, B., Hayworth, J., and Austin, L., 2006. Review of methods used to reduce urban stormwater loads: Task 3.4. A Technical Report of the Regional Watershed Program: SFEI Contribution #429. San Francisco Estuary Institute, Oakland, CA.

O'Hara, Jan 2012. San Francisco Bay Regional Water Quality Control Board PCBs TMDL Manager. *Personal communication*. August 6, 2012.

Pacific Gas & Electric Company (PG&E) 2000. Correspondence from Robert Doss, PG&E's Environmental Support and Service Principal in response to San Francisco Regional Water Quality Control Board information request on historic and current PCB use. Pacific Gas and Electric Company, San Francisco, CA. September 1, 2000.

San Francisco Regional Water Quality Control Board (SFRWQCB) 2015. *Municipal Regional Stormwater NPDES Permit, Order R2-2015-0049. NPDES Permit No. CAS612008*. California Regional Water Quality Control Board, San Francisco Bay Region. November 19, 2015.

San Francisco Regional Water Quality Control Board (SFRWQCB). 2016. Fact Sheet: San Francisco Bay PCBs TMDL – Implementation at Cleanup & Spill Sites. March 2016. Available at https://www.waterboards.ca.gov/sanfranciscobay/water_issues/programs/TMDLs/sfbaypcbs.

San Francisco Regional Water Quality Control Board (SFRWQCB). 2017. San Francisco Bay Basin (Region 2) Water Quality Control Plan (Basin Plan). California Regional Water Quality Control Board, San Francisco Bay Region. Oakland, CA.

Sanchez, Daniel 2016. Manager of HazMat and Water Quality Environmental Management Programs, Pacific Gas & Electric Company (PG&E). *Personal communication*. February 25, 2016.

Santa Clara Valley Urban Runoff Pollution Prevention Program (SCVURPPP) 2018. Potential Contributions of PCBs to Stormwater from Electrical Utilities in the San Francisco Bay Area. Overview and Information Needs. Prepared by EOA, Inc. September 2018.

State Energy Commission 2015. http://www.energy.ca.gov/almanac/electricity_data/utilities.html

Appendix 4

Marsh Creek Stressor and Source Identification Study: Year 1 Status Report

This page intentionally blank

Contra Costa Clean Water Program

Marsh Creek Stressor and Source Identification Study:

Year 1 Status Report

Submitted to



Contra Costa Clean Water Program
255 Glacier Drive
Martinez, California 94553

March 27, 2019

Submitted by



Wood Environment & Infrastructure Solutions, Inc.
180 Grand Avenue, Suite 1100
Oakland, California 94612

and



ADH Environmental
3065 Porter Street, Suite 101
Soquel, California 95073

This page intentionally blank

Contra Costa Clean Water Program

Marsh Creek Stressor and Source Identification Study Year 1 Status Report

March 27, 2019

Submitted to

Contra Costa Clean Water Program
255 Glacier Drive
Martinez, California 94553

Submitted by

Wood Environment & Infrastructure Solutions, Inc.
180 Grand Avenue, Suite 1100
Oakland, California 94612

and

ADH Environmental
3065 Porter Street, Suite 101
Soquel, California 95073

This page intentionally blank

TABLE OF CONTENTS

Acronyms and Abbreviations.....	iii
Executive Summary.....	v
1. Introduction and Background.....	1
2. Approach.....	5
3. Findings.....	7
3.1 2018 Observations by Field Staff.....	7
3.2 Grab Sample Results.....	7
3.3 Continuous Water Level and Quality Monitoring.....	8
3.4 Sources of Dry Weather Flow.....	16
4. Summary and Planned Activities for 2019 monitoring.....	19
5. References.....	21

List of Tables

Table 1. Analytical Tests, Methods, Reporting Limits and Holding Times for Water and Sediment Chemistry Testing.....	5
Table 2. Results of Chemical Analysis of Grab Samples.....	8
Table 3. Management Hypotheses, Associated Monitoring Approaches, and Status at Conclusion of Year 1.....	20

List of Figures

Figure 1. Map of Study Area and Relevant Watershed Features.....	3
Figure 2. Stick Diagram of Monitoring Stations and Continuous Stage and Water Quality Monitoring Data from Stations M2.....	9
Figure 3. Stick Diagram of Monitoring Stations and Continuous Stage and Water Quality Monitoring Data from Station M2.....	10
Figure 4. Continuous Stage and Water Quality Monitoring Data from Stations M1 and M0*.....	11
Figure 5. Comparison of Stage to Dissolved Oxygen at M2, August 15-October 31, 2018.....	12
Figure 6. Stage at Station M2 and Daily Minimum Dissolved Oxygen at M0 (Upper) and Dissolved Oxygen at M0 vs Stage at M0 for Four 3-day Periods (Lower).....	14
Figure 7. Stage at M2 (Upper) and at Upstream HOBOWater Level Monitoring Stations (Lower) During Year 1 Monitoring.....	15

This page intentionally blank

Acronyms and Abbreviations

BOD	biochemical oxygen demand
Brentwood	City of Brentwood
CCCWP	Contra Costa Clean Water Program
CDFW	California Department of Fish and Wildlife
mgd	million gallons per day
MRP	Municipal Regional Stormwater NPDES Permit
NPDES	National Pollutant Discharge Elimination System
SFRWQCB	Regional Water Quality Control Board, San Francisco Region
SSC	suspended sediment concentration
SSID	stressor and source identification
WTP	wastewater treatment plant

This page intentionally blank

EXECUTIVE SUMMARY

This stressor and source identification (SSID) study (study) addresses the root causes of fish kills in Marsh Creek. The study approach follows a work plan developed by CCCWP and approved by the CCCWP Monitoring Committee. The study focuses on low dissolved oxygen as the primary suspect cause of fish kills. The possibility that pesticides or other factors contributed to fish mortality was also evaluated in this study.

Continuous monitoring of water levels, dissolved oxygen, temperature, conductivity, turbidity, and pH at three locations along Marsh Creek helps understand daily and season factors that affect dissolved oxygen. The locations monitored were just upstream of the City of Brentwood Wastewater Treatment Plant (WTP) and immediately downstream of the WTP. Grab sampling was performed during dry weather flow events to quantify pesticides and biochemical oxygen demand. Additional water level sensors and field investigations helped identify sources of dry weather flow.

In contrast to prior years during this study, there were no mass fish mortality events observed in 2018. There was a minor event on May 16, 2018 when Friends of Marsh Creek volunteers observed six dead fish and around 10 dead crayfish in Marsh Creek. Crayfish mortality was concurrently observed by CCCWP monitoring contractors. The suspected cause of fish mortality is stranding in isolated pools following a marked decrease in flows, associated with elevated temperature, pH and low dissolved oxygen. The crayfish mortality is more puzzling, because they are generally hardier compared to fish in coping with low dissolved oxygen and high temperatures in marginal habitats (Grow and Merchant, 1980; Westoff et al., 2016).

Dissolved oxygen concentrations cycle on a daily basis at all three locations monitored. Supersaturated concentrations exceeding 10 mg/L are reached at mid-day when photosynthesis peaks. The pH also peaks at mid-day, at times exceeding 9 in isolated pools upstream of the WTP, but not downstream. Dissolved oxygen minima (and associated pH minima) occur nightly between about 2:00 a.m. and daybreak due to the metabolic shift of attached algae and aquatic plants from photosynthesis to respiration. At the monitoring station immediately downstream of the WTP, the nightly dissolved oxygen minimum rarely went below 5 mg/L (the water quality objective for warm water fisheries habitat), and never went below 3 mg/L (a threshold below which mortality becomes increasingly likely). However, at the monitoring stations both upstream of the WTP and 2 miles downstream from the WTP, dissolved oxygen concentrations dipped below 5 mg/L on a nightly basis from June through October, and in August went below 2 mg/L, a level at which fish mortality is highly likely if escape or avoidance is impossible.

Antecedent flow conditions appear to affect the nightly dissolved oxygen minimum. The nightly dissolved oxygen minimum declined steadily through the summer until about September. During this period of decline, dry weather flow events were followed a few days later by a slight uptick in the nightly dissolved oxygen minimum compared to the running seven-day average. At the beginning and the end of the summer, during more prolonged periods of dry weather flow, cessation of flows was associated with a drop in the nightly dissolved oxygen minimum.

Sources of dry weather flows varied. In early June, dry weather flows appeared to originate from different tributaries to Marsh Creek (Sand Creek, Deer Creek and Dry Creek) at different times. On May 15-16, a dry weather flow that preceded the observation of crayfish and fish mortality appeared to originate from an 18-inch corrugated metal pipe located along the west bank of Marsh Creek near Sunset Road. At the end of June, a substantial dry weather flow event originated from Dry Creek. On July 17-18, field inspectors identified Deer Creek as the predominant source of the dry weather flow event. Field crews collecting water samples from that Deer Creek event also noted a strong smell of chlorine. A five-week period of dry weather flow ensued beginning in late August and ending in early October. Field inspectors determined the origin of the flow was an agricultural drainage discharging to Sand Creek

Chemical analysis of samples grabbed during the July 17 dry weather flow event and during the prolonged September flow event were mostly non-detect for pesticides. Detections of fipronil breakdown products and bifenthrin were very close to or just below reporting limits. Nothing unusual was noted about the concentrations of other constituents analyzed (e.g., ammonia, sulfide, biochemical oxygen demand).

At the conclusion of Year 1, the findings indicate that the study appears to be on the right track by focusing on low dissolved oxygen. Dissolved oxygen levels low enough to cause fish mortality were indeed observed about 2 miles downstream from the Brentwood WTP at Cypress Boulevard during August of 2018, although no fish mortality events were observed. The daily cycling of dissolved oxygen and pH points to photosynthesis and respiration by algae and aquatic plants as the main cause of night time dissolved oxygen depression. The minimum dissolved oxygen levels reached appear to be influenced by flow, regardless of flow source.

The detection (by smell only) of chlorine in a dry weather flow event raises the possibility of planned or unplanned potable water discharge as a potential source of flow. This will be looked into during Year 2 by communicating with East Bay Municipal Utility District, which has a water supply main that crosses Marsh Creek. The goal of communication will be to better understand their schedule of planned discharges for system maintenance, record of 2018 discharges, and chlorine removal best management practices implemented.

In 2019, continuous water quality monitoring using Sondes will continue at the same three locations monitored in 2018. Opportunistic grab sampling of dry weather flow will also continue, and field crews will bring a chlorine test kit to make field chlorine measurements during future site inspections and sampling events. CCCWP staff will work with the City of Brentwood WTP to develop a pilot project concept to evaluate the potential for overnight flow equalization from the WTP to increase the nightly dissolved oxygen minima 2 miles downstream at Cypress Boulevard.

1. INTRODUCTION AND BACKGROUND

This stressor and source identification (SSID) study (study) addresses the root causes of fish kills in Marsh Creek. Completion of this study will fulfill the requirements for Contra Costa Permittees of Provision C.8.e of the Municipal Regional Stormwater NPDES Permit (MRP) issued by the San Francisco Bay Regional Water Quality Control Board.

The primary objective of the study is to identify root causes of fish kills in Marsh Creek. Following the assumption that the most common cause of fish kills is hypoxia, the first step has been to determine whether low dissolved oxygen causes fish kills in Marsh Creek and, if so, to determine the causes of the low dissolved oxygen. A primary suspected cause of low dissolved oxygen is algal growth in reaches subject to intermittent non-stormwater flows; therefore, identifying sources of non-stormwater flow is an important objective of this study. An alternate hypothesis, not necessarily exclusive of low dissolved oxygen, is that pesticide toxicity causes fish kills. Proving or disproving pesticide linkages is more complex compared to identifying low dissolved oxygen as a root cause; therefore, the objective for the pesticide assessment is to provide the most substantive weight of evidence achievable within the schedule and budget for this study.

There have been nine documented fish kills over the past 14 years in Marsh Creek, dating back to 2005 (CCCWP, 2018 and citations therein). These events are often associated with intermittent dry season flows or storm events with varying antecedent dry periods. The most recent event occurred in October 2017.

The study area extends from below the Marsh Creek Reservoir downstream to the City of Oakley (Figure 1). Tributaries entering this portion of Marsh Creek include Dry Creek, Sand Creek, and Deer Creek. Streamflow in the creek is generally low, but rarely dry, during most of the summer. Known sources of dry weather flow are associated with wastewater treatment plant discharge, agricultural irrigation return flows, and non-stormwater urban drainage from the Brentwood area. Seasonal stormwater flows, the effects of urban development, and agricultural runoff contributions have significant impacts on the quality and quantity of water in Marsh Creek.

The City of Brentwood Wastewater Treatment Plant (WTP), located approximately 3.6 miles southwest of the Delta at Big Break, treats sanitary wastewater from nearby residential areas and discharges its effluent into Marsh Creek, as authorized by a National Pollutant Discharge Elimination System (NPDES) permit. The treatment plant has a design capacity of 5 million gallons per day (mgd); present actual flows are more typically in the range of 2 to 3 mgd, depending in part on recycled water consumption by irrigators.

The WTP creates a relatively constant body of flowing water in Marsh Creek downstream of its outfall. In the region below the WTP flow rates tend to peak mid-day, following peaks in early morning residential usage, and are at minimum in the pre-dawn hours. Upstream of the WTP outfall, flows are more intermittent, resulting from more intermittent activities. There are a multitude of farms, businesses, and storm drains which discharge stormwater and non-stormwater runoff into Marsh Creek. Agricultural and golf course irrigation, hydrant flushing, planned discharges during water transmission system

maintenance, and residential irrigation are all potential sources of non-stormwater flow into Marsh Creek.

Figure 1. Map of Study Area and Relevant Watershed Features

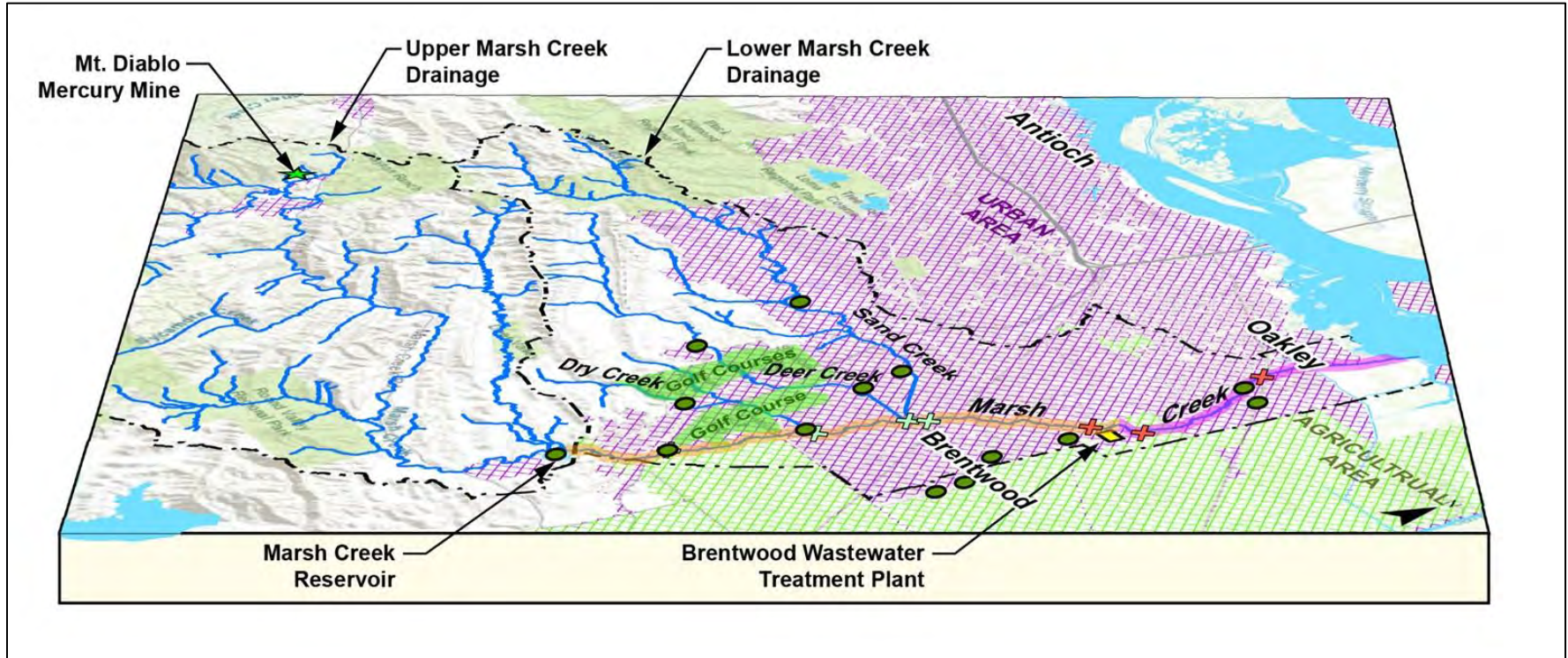

This page intentionally blank

2. APPROACH

The study approach follows a work plan developed by CCCWP and approved by the CCCWP Monitoring Committee (CCCWP, 2018). Continuous monitoring of water levels, dissolved oxygen, temperature, conductivity, turbidity, and pH at three locations along Marsh Creek helps understand daily and season factors that affect dissolved oxygen. The locations monitored were just upstream of the City of Brentwood Wastewater Treatment Plant (WTP), immediately downstream of the WTP, and 2 miles downstream at Cypress Boulevard, grab sampling was performed during dry weather flow events to quantify pesticides and biochemical oxygen demand. Additional water level sensors and field investigations helped identify sources of dry weather flow. Locations of water quality and water level sensors are indicated in Figure 2.

Constituents analyzed in grab samples are summarized in Table 1. During grab sampling events, field staff also inspected Marsh Creek upstream of the WTP to attempt to identify sources of dry weather flow.

Table 1. Analytical Tests, Methods, Reporting Limits and Holding Times for Water and Sediment Chemistry Testing

Analyte	Matrix	Test Method	Reporting Limit	Holding Time
Suspended Sediment Concentration	Water	ASTM D3977-97B	3 mg/L	7 days
Pesticides ¹	Water	EPA 8270M	1.5 ng/L to 2 µg/L	7 days
Ammonia	Water	SM 4500 NH3 C	0.1 mg/L	28 days
Biochemical Oxygen Demand 5-Day	Water	SM 5210B	2 mg/L	48 hours
Total Sulfides	Water	SM 4500-S2	0.1 mg/L	7 days
Total Organic Carbon	Water	SM 5310 B-00/-11	±0.1 %	28 days
Dissolved Organic Carbon	Water	SM 5310 B-00/-11	0.50 mg/L	Filter 48 hours, 28 days

¹ Pyrethroids, chlorpyrifos, diazinon, fipronil and degradates

This page intentionally blank

3. FINDINGS

This section presents the findings from year 1 of the study. Relevant observations by field staff are presented first, followed by results of chemical analysis of grab samples collected from dry weather flow events. Continuous monitoring results for water are summarized to help understand the major processes affecting water quality during the dry season. Water level monitoring results from locations upstream of the water quality sensors are presented at the end of the section to help understand different sources of dry weather flow.

3.1 2018 Observations by Field Staff

While performing bioassessments on May 16, CCCWP noted six dead crayfish in Marsh Creek in the vicinity of Dainty Avenue. This observation was corroborated by volunteer monitors working with Friends of Marsh Creek and American Rivers, who were also performing bioassessment surveys May 14-16. The volunteers reported that six dead fish and around 10 dead crayfish were observed in Marsh Creek near Creekside Park. The creek was mostly dry with isolated pools during the previous week; a dry weather flow event peaking around mid-day on May 15 preceded the May 16 observations of dead crayfish. Field crews observed that the origins of the May 15-16 flows appeared to be an 18-inch corrugated metal pipe outfall located on the west bank of Marsh Creek. The outfall is adjacent to a what appears to be a pump house located at the intersection of McHenry Way and Sunset Road, about three miles downstream of the dead crayfish observations.

Field crews were present for equipment maintenance during two other dry weather flow events, on July 17, 2018 and on October 4, 2018. On July 17, flows were traced to Deer Creek, from evidence of pooled water, field crews noted that where their arms had necessarily come into contact with the creek during sampling, they smelled of chlorine, as if they had been in a swimming pool. Field crews did not have chlorine test kits available at that time. The October 4 flows were traced to Sand Creek. Both the July 17 and the October 4 dry weather flow events were sampled for the constituents listed in Table 1.

3.2 Grab Sample Results

Results from chemical analysis of grab samples collected during dry weather flow events in July and October of 2018 are summarized in Table 2. Neither flow event showed particularly unusual or concerning water quality characteristics. Suspended sediment concentrations were either low (3.2 mg/L) or non-detect. Most pesticides were at or below the reporting limit and many were below the detection limit. Biochemical oxygen demand (BOD) was relatively low (6 mg/L) in July and non-detect (<5 mg/L) in October. Ammonia concentrations ranging from 0.03 to 0.05 mg/L are comparable to background ammonia concentrations in natural waters.

Table 2. Results of Chemical Analysis of Grab Samples

Constituent (Units)	Results			MDL	RL
	Marsh Creek at M2 07/17/18	Marsh Creek at M2 10/03/18	Sand Creek at Flow Source 10/04/18		
Suspended Sediment Concentration (mg/L)	3.2	<2	<2	2	3
Allethrin (ng/L)	<0.1		<0.1	0.1	0.5
Bifenthrin (ng/L)	0.4J		1.1	0.1	0.5
Chlorpyrifos (ng/L)	<0.5		<0.5	0.5	1
Cyfluthrin, total (ng/L)	<0.2		<0.2	0.2	0.5
Cyhalothrin, Total lambda- (ng/L)	<0.2		<0.2	0.2	0.5
Cypermethrin, total (ng/L)	<0.2		0.4J	0.2	0.5
Diazinon (ng/L)	<0.1		<0.1	0.1	0.5
Deltamethrin/Tralomethrin (ng/L)	<0.2		<0.2	0.2	1
Esfenvalerate/Fenvalerate, total (ng/L)	<0.2		<0.2	0.2	1
Fenpropathrin (ng/L)	<0.2		<0.2	0.2	0.5
Fipronil (ng/L)	<0.5		<0.5	0.5	1
Fipronil Desulfinyl (ng/L)	1.2		<0.5	0.5	1
Fipronil Sulfide (ng/L)	<0.5		<0.5	0.5	1
Fipronil Sulfone (ng/L)	1.7		0.8J	0.5	1
T-Fluvalinate (ng/L)	<0.2		<0.2	0.2	0.5
Permethrin, Total (ng/L)	<2		<2	2	10
Tetramethrin (ng/L)	<0.2		<0.2	0.2	0.5
Ammonia as N (mg/L)	0.05		0.032	0.015	0.02
BOD (mg/L)	6	<5	<5	5	5
Sulfide, Total (mg/L)	<0.03		<0.03	0.03	0.1
Total Organic Carbon (mg/L)	7.6		2.9	0.3	1
Dissolved Organic Carbon (mg/L)	7.3		2.5	0.3	1

3.3 Continuous Water Level and Quality Monitoring

Water levels and quality were successfully monitored in Marsh Creek at three locations upstream of the WTP (Station M2), immediately downstream of the WTP (Station M1), and 2 miles downstream at Cypress Boulevard (Station M0), as shown in Figure 3 and Figure 4. A stick diagram of Marsh Creek and its tributaries shown with Figure 2 helps organize the spatial distribution of monitoring locations.

Water level monitoring confirms that flows are intermittent upstream of the WTP, whereas downstream water levels peak daily and diminish to their minima at night, as evidenced by the daily oscillations in stage at M1 and M0. The fact that all three monitoring locations have some measurable water levels, even at times of no flow (for example, M1 had measurable water levels [stage values] even when flow from the WTP drops to zero for a few hours most nights), underscores an important observation about Marsh Creek that was first noted during development of the work plan for this study: Marsh Creek functions as a series of interconnected pools during low flow periods.

Figure 2. Stick Diagram of Monitoring Stations and Continuous Stage and Water Quality Monitoring Data from Stations M2

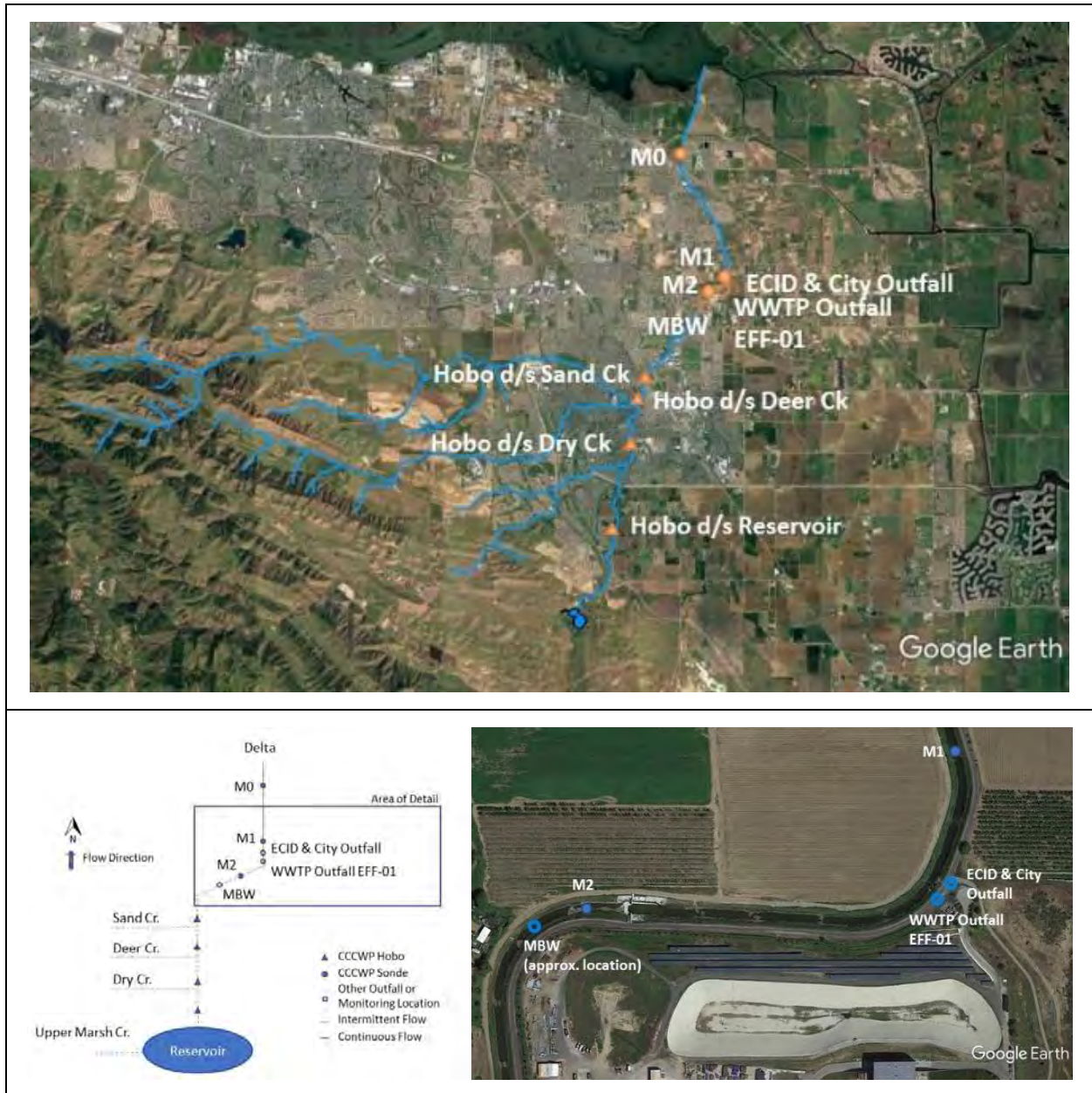

Figure 3. Stick Diagram of Monitoring Stations and Continuous Stage and Water Quality Monitoring Data from Station M2

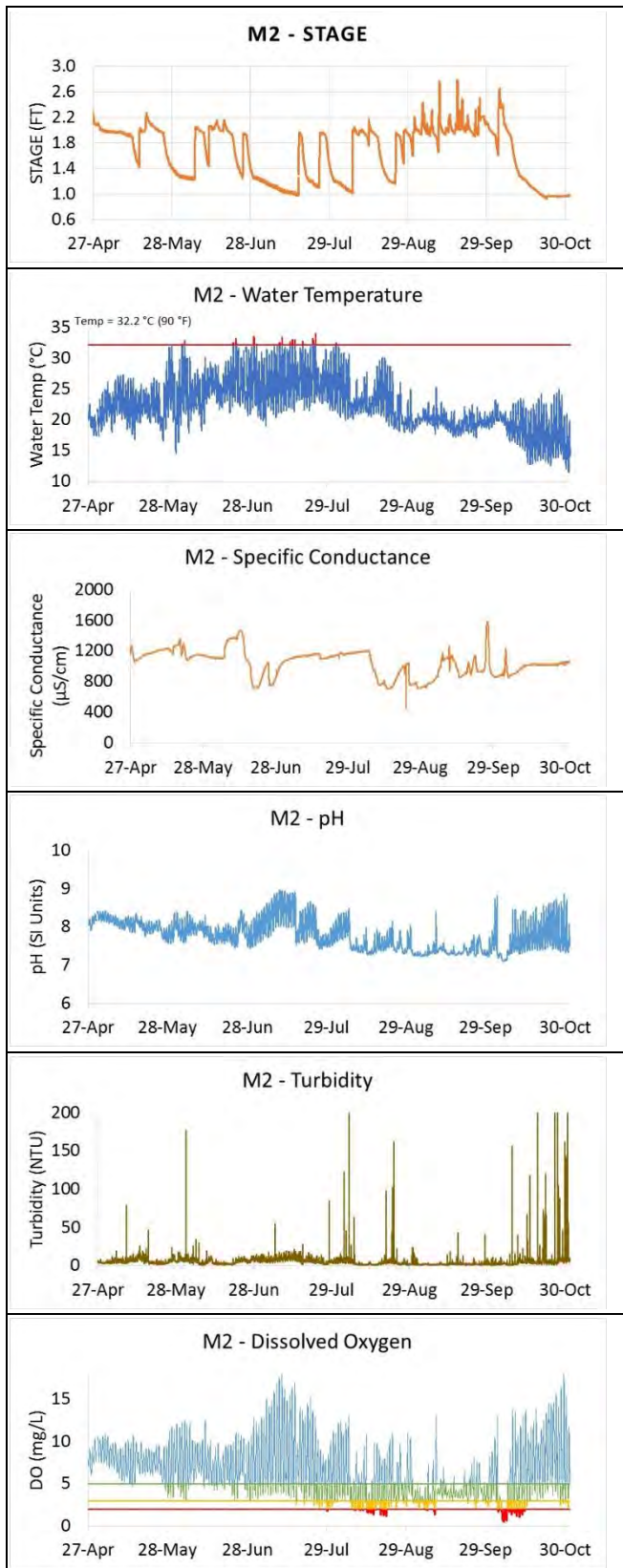
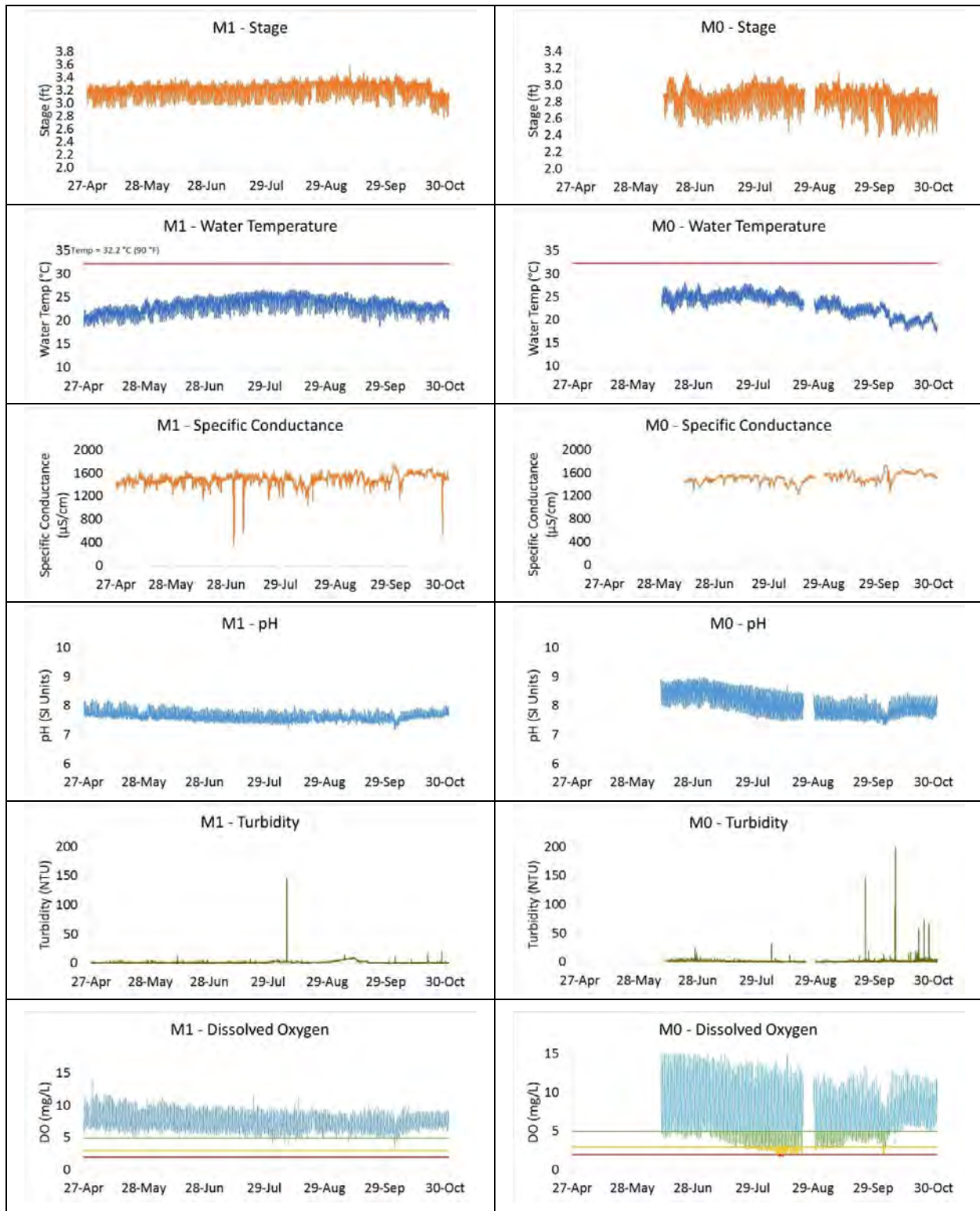

Figure 4. Continuous Stage and Water Quality Monitoring Data from Stations M1 and M0*



*An equipment malfunction at M0 resulted in missing stage data between August 24-29 and missing water quality data from August 26-29.

Marsh Creek downstream of the reservoir has been highly modified over the past several decades. The channel has been straightened, hardened and grade control structures have been installed to reduce erosion of the channel bottom that resulted from channel modifications. These structures create a series of pools and riffles that provide habitat for aquatic species, plant and algae. The pools and riffles also affect water quality. Upstream of the WTP, pools that are filled by intermittent dry weather flows tend to stagnate during summer months when flows cease, reaching temperatures exceeding 90° Fahrenheit and dissolved oxygen concentrations below 2 mg/L.

Water quality conditions steadily deteriorated at M2 through the summer. Water temperatures exceeded 90° Fahrenheit regularly at M2 in June and July. Dissolved oxygen and pH showed daily oscillations that are typical of streams with abundant algae. Photosynthesis during the day produces oxygen, leading to supersaturation at mid-day; at the same time, carbon dioxide is consumed, increasing the pH of water by day to nearly 9. The opposite occurs at night, when plant metabolism consumes dissolved oxygen and releases carbon dioxide, thereby concurrently lowering pH.

Dissolved oxygen began dropping below the water quality objective of 5 mg/L at M2 on a nightly basis starting in late May. By the end of July, the nightly dissolved oxygen minimum at M2 was consistently below 3 mg/L, and at times was below 2 mg/L. Dissolved oxygen at M2 picked up with the onset of dry weather flows from Sand Creek in September, and then crashed abruptly to below 2 mg/L when those dry weather flows tailed off October 2-6. Dissolved oxygen at M2 clearly responds directly to flow, as seen by the sudden drop in dissolved oxygen in responses to the falling stage on October 2, followed by a dissolved oxygen uptick concurrent with a stage rise on October 4, followed by another sudden drop as flows tailed off October 5-6 (Figure 5). Temperature also stabilized at M2 during the dry weather flow event of September (see Figure 3).

Figure 5. Comparison of Stage to Dissolved Oxygen at M2, August 15-October 31, 2018

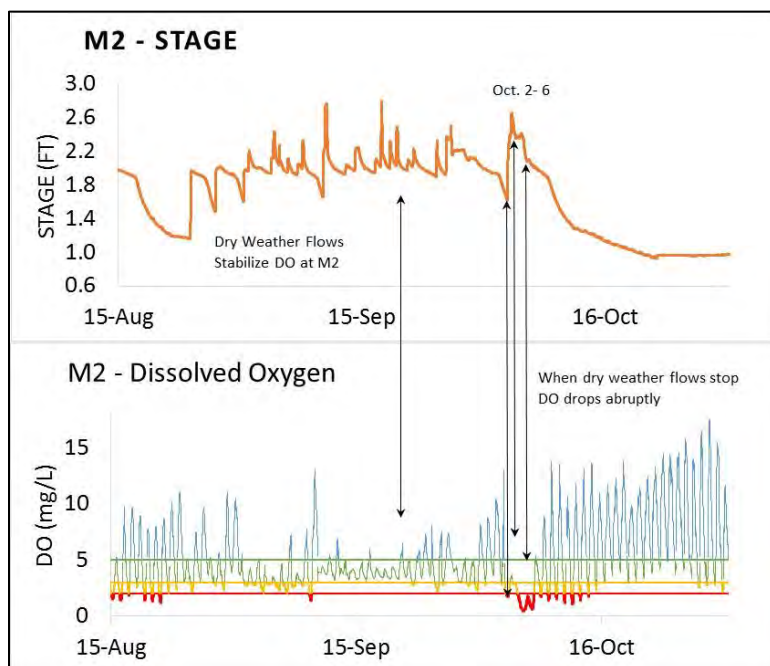

Water quality was relatively stable at M1, immediately downstream of the WTP outfall, during the period monitored (see Figure 4). Dissolved oxygen and pH showed daily oscillations consistent with photosynthesis and respiration. In contrast with location M2, pH at M1 remained within a much tighter range (7.2 to 8.2) and dissolved oxygen went below 5 mg/L only a few times, and never went below 3 mg/L during the period monitored. This stable behavior of water quality is attributable to daily flows from the WTP. Without daily replenishment from WTP discharges, water quality in the pool at M1 would likely resemble that of the pool at M2, upstream of the WTP.

Daily flows from the WTP reach 2 miles downstream to station M0. Stage peaks at M0 occur about 5 to 6 hours after stage peaks at M1, implying a transit time of about 5 to 6 hours between the two locations at peak daily flow. Although Marsh Creek at M0 should have roughly the same flows as 2 miles upstream at M1, dissolved oxygen is notably worse at M0 compared to M1 (see Figure 4). The nightly dissolved oxygen minimum at M0 began regularly dropping below 5 mg/L by the end of July and fell below 2 mg/L by mid-August.

Dissolved oxygen at M0 is of interest in this study because of the location in relation to fish habitat and passage. The most likely place to find fish during the late summer and early fall is downstream of the WTP, because upstream habitat quality is demonstrably less hospitable during those times. Based on the observations from the summer of 2018, a potential scenario leading to a fish kill would be if fish in reaches downstream from the WTP are trapped in pools during overnight no-flow periods, when lethally low dissolved oxygen levels (<2 mg/L) can occur. Station M0 is an important indicator of the potential for this scenario.

A more detailed analysis helps understand factors affecting dissolved oxygen at M0 (Figure 6). The overall seasonal pattern is displayed in the top of Figure 5, and four different snapshots of the 24-hour photosynthesis/metabolism cycle are shown in the bottom of Figure 6. The hysteresis loops observed in the bottom of Figure 6 result from daily oscillations in dissolved oxygen and water level that are out of phase. Dissolved oxygen at M0 drops overnight because of net respiration, and also because diminishing flows lead to diminished re-aeration rates. Of the two factors, the photosynthesis/respiration cycle seems to exert a more potent effect on dissolved oxygen than diminishing flow. At daybreak, dissolved oxygen at M0 increases even as the stage continues to drop at that location. At those lower pre-dawn water levels, the waterbody is essentially functioning as a pool; a stage drop of a few more inches does not significantly alter the “pool-like” characteristics. The onset of daylight and associated shift from metabolism to photosynthesis turns the dissolved oxygen state from net consumptive to net productive each day.

Figure 6. Stage at Station M2 and Daily Minimum Dissolved Oxygen at M0 (Upper) and Dissolved Oxygen at M0 vs Stage at M0 for Four 3-day Periods (Lower)

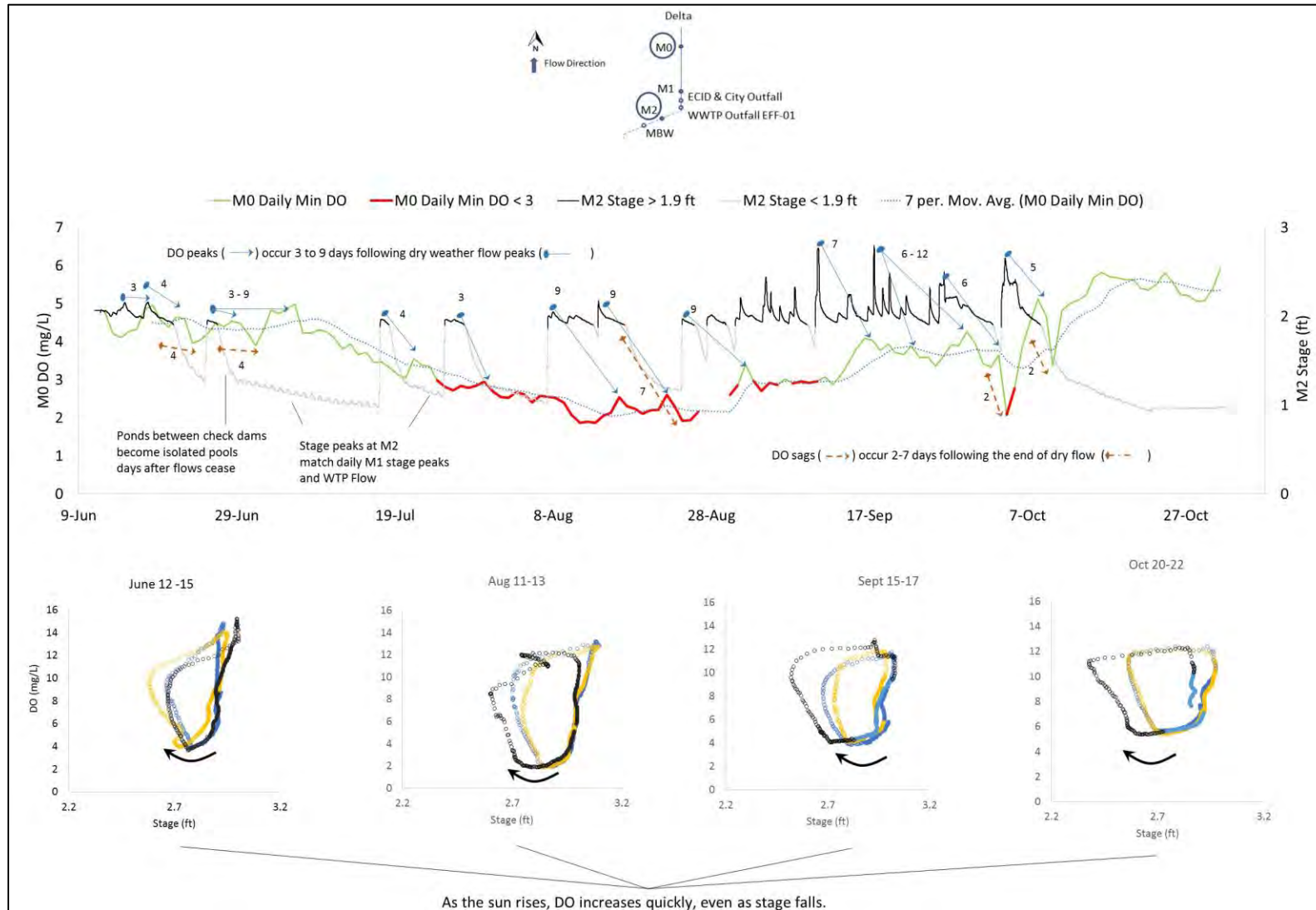
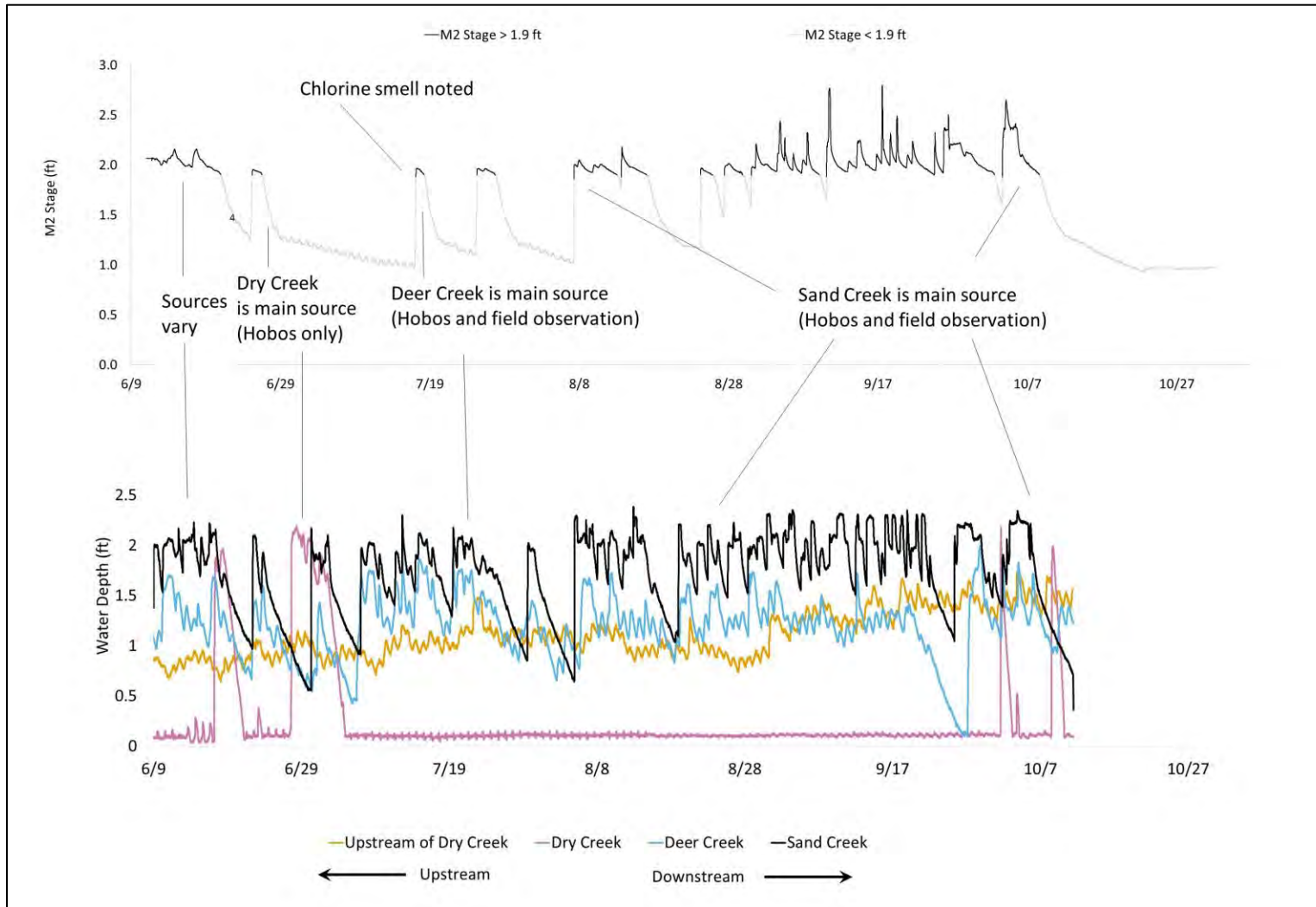

Figure 7. Stage at M2 (Upper) and at Upstream HOB0 Water Level Monitoring Stations (Lower) During Year 1 Monitoring



Flow from upstream of the WTP appears to affect the nightly minimum dissolved oxygen concentrations reached at M0. This is important because it is the minimum dissolved oxygen that would cause fish mortality, rather than the daily average or the daily maximum. It appears the dissolved oxygen at M0, like at M2, tracks with dry weather flows recorded at M2. Even though WTP flows drop to zero on a nightly basis, the nightly minimum of dissolved oxygen appears to be higher at M0 after dry weather flows occur at M2.

As indicated by the numbered dots and arrows in Figure 6, peak dry weather flows are followed three to nine days later by a peak in the daily minimum dissolved oxygen compared to the running seven-day average of daily dissolved oxygen minima. Likewise, two to four days after a dry weather flow event ceases, there is an abrupt sag in the daily dissolved oxygen minimum compared to the running seven-day average of minima.

The nature of this dry weather flow regime upstream of the WTP is also evidenced in the pattern of stage rising and falling. Actual surface flow occurs at M2 when water levels at M2 exceed 1.9 feet (bold black line in upper portion of Figure 6). Below 1.9 feet, water between grade control structures at M2 seeps off to become an isolated pool over a period of days. Following that, daily stage peaks are observed mid-day at M2, coincident with the stage peak at M1 and daily peak flows from the WTP. This oscillation indicates that M2 remains hydraulically connected to M0 via the hyporheic zone (the zone of mixed surface and groundwater below and adjacent to a stream). The sandy soils beneath Marsh Creek are highly transmissive (City of Brentwood, 2016), allowing water to flow freely back and forth between adjacent ponds as water levels rise and fall.

The combination of intermittent dry weather flows upstream of the WTP, grade control structures forming a series of pools, and a highly transmissive hyporheic zone sets the dry weather flow regime for the Marsh Creek watershed between the reservoir and the WTP. Intermittent flows would drain off more quickly were it not for the grade control structures. Instead, water from dry weather flows is retained in pools behind the grade control structures and slowly released downstream by seepage through the hyporheic zone. This establishes a “tail-off” period following dry weather flows, leading to the observed lag time between cessation of dry weather flows and drops in the dissolved oxygen daily minimum compared to antecedent conditions. Even though the cycle of photosynthesis and respiration is a dominant factor affecting dissolved oxygen at M0, a small amount of residual dry weather flow from upstream of the WTP appears to have a detectable positive effect of increasing the nightly dissolved oxygen minimum reached two miles downstream of the WTP at M0.

3.4 Sources of Dry Weather Flow

Water level monitoring upstream of the WTP using HOBO® data loggers (Figure 7), combined with observations from the field, confirm that there are a variety of dry weather flow sources to Marsh Creek. In the lower portion of Figure 7, stage rises detected by the HOBO® can be tied to stage rises at M2 (upper portion of Figure 7) to infer flow sources by tributary. When the black line in the lower portion of Figure 6 rises, indicating a stage rise Marsh Creek immediately downstream of Sand Creek, but none of the other three HOBO sensors show significant stage rises, this indicates flow is

predominantly from Sand Creek. This was the case in September 2018 and was confirmed by field observation.

On July 17, 2018, when a chlorine smell was noted in dry weather flows sampled, the dry weather flow was predominantly from Deer Creek, again confirmed both by field observation and the fact that HOBOS downstream of Deer Creek and Sand Creek showed stage rises, but the two HOBOS[®]s located further upstream did not. Around the end of June, Dry Creek contributed dry weather flow. Prior to that, tributary sources of flow varied.

This page intentionally blank

4. SUMMARY AND PLANNED ACTIVITIES FOR 2019 MONITORING

In summary, the first year of the Marsh Creek SSID study was successful in collecting data on dissolved oxygen and other water quality parameters, grab sampling dry weather flow events, and identifying the location and timing of different sources of tributary flow. Although a major fish kill event did not occur during Year 1, the dissolved oxygen data supports the hypothesis that previously observed mass fish kills (> 100 fish) observed in the reaches downstream of the WTP were likely caused at least in part by low dissolved oxygen events.

The Year 1 findings also show there may be more than one cause of fish kills. Continuous monitoring devices in place at M2 did not show lethally low dissolved oxygen and high temperatures on May 16, when dead fish and crayfish were observed by contractors and volunteer monitors. The dry weather flow event that took place immediately before the May 16 observations could have played a role, either by luring fish upstream to be stranded after the flow abated, or by the potential presence of toxic substances in the dry weather flow. Temperature also may have played a role following the cessation of dry weather flows.

Investigation of toxicity to date has focused on pesticides. Both from chemical analysis and from the history of toxicity testing, there has not been evidence to date of pesticide toxicity to higher organisms such as fish. The observation by field staff that the June 17 dry weather flow event smelled of chlorine is troubling, in that chlorine in a dry weather discharge could potentially explain crayfish mortality if chlorine was also present in the May 15-16 dry weather discharge.

For the coming year, continuous water quality monitoring and opportunistic grab sampling will continue per the work plan. The grab sampling program will be expanded to include chlorine testing in the field. CCCWP will work with local permittees (the City of Brentwood) to see if local support can provide rapid response testing of dry weather discharges for chlorine. CCCWP will also reach out to the irrigated agriculture monitoring coalition covering Marsh Creek to better understand the timing and volumes of irrigation runoff to Marsh Creek. CCCWP will also reach out to municipal water suppliers, such as East Bay Municipal Utility District, the Contra Costa Water District, and the City of Brentwood, to gather data on planned potable water discharges and implementation of chlorine-removing best management practices.

As a result of a recent pond rehabilitation project, the City of Brentwood's WTP will have the capability to store and equalize flows from its outfall beginning in 2019. The primary purpose of this capability is to provide irrigation customers with water at night, when they need it, and when water production from the WTP is at a minimum. The WTP operations manager has agreed in concept to evaluate a flow equalization pilot study during Year 2, to determine if storing water by day and releasing water by night can raise the nightly dissolved oxygen minimum. This would be attempted in the July-August time frame, targeting a window when dry weather flows are at a minimum.

Table 3 below summarizes the management hypotheses and evaluation approaches proposed in the work plan for this study, along with a statement of the current status for each item.

Table 3. Management Hypotheses, Associated Monitoring Approaches, and Status at Conclusion of Year 1

Hypotheses	Evaluation Approach	Schedule or Status
Low dissolved oxygen causes fish kills	Compile historic WTP effluent and receiving water monitoring Review and summarize time of day and antecedent weather for historic fish kills	Completed during work plan development
	Perform continuous monitoring of dissolved oxygen, pH, conductivity, turbidity, and temperature at three locations upstream and downstream of the WTP	Successfully completed in 2018. Pulled sondes and HOBOS as of December 2018. Will resume March 2019
Low dissolved oxygen upstream of the WTP is caused by excessive algal blooms	Compare algal abundance, ash free dry weight, and magnitude of dissolved oxygen swings among Contra Costa County creeks	Completed during work plan development
Episodic non-stormwater flows are the result of agricultural irrigation, golf course irrigation, residential irrigation, or maintenance flushing of potable water systems.	Perform continuous monitoring of water levels at several locations within the watershed using sondes and HOBOS (see Figure 1)	Water level sensors installed as of April 2018, will resume February 6, 2019 at the end of the rainy season
	Issue email alerts when non-stormwater flows increase in the creek commence	Email alerts are being sent as of April 2018
	Develop a map and inventory of storm drain outfalls Opportunistically dispatch inspectors to identify and potentially sample sources of flow	Map deferred, may not be necessary. 2018 field inspections identified two flow sources.
Stagnant water is flushed from upstream of M1 and the WTP to the lower creek during episodic dry weather flow spikes and first flush rain events	Collect water samples for BOD, sulfides, total organic carbon, and total suspended solids during dry weather base flow conditions, during dry weather flow surges, and during first flush storm events.	Three events sampled for BOD and SSC; two of three also analyzed for TOC and sulfide.
Flushing of stagnant water from upstream of the WTP can cause lethally low dissolved oxygen downstream	Develop a simple WASP-8 water quality model to determine BOD loads needed to explain observed sags in dissolved oxygen. Compared modeled BOD loads to monitored loads.	Preliminary modeling performed. Recommend 2019 flow equalization pilot in cooperation with Brentwood in lieu of additional modeling.
Non-stormwater discharges contain elevated levels of BOD and / or pesticides	Opportunistically dispatch inspectors to sample sources of flow	Two events sampled
Pesticides cause fish kills	Continue to monitor toxicity and pesticides in Marsh Creek in compliance with Provision C.8.g	Completed per permit
	Collect an opportunistic sample for pesticides and toxicity as soon as practicably possible immediately following a fish kill event	No sampleable fish mortality events occurred from June-November 2018
Pesticides cause crayfish kills	Coordinate with CDFW to find out if they would partner to provide analysis of pesticides in fish and crayfish tissues	Had discussion with CDFW in July 2018. They are willing to provide tissue analysis.
Daily pH peaks cause ammonia toxicity to increase, causing or contributing to mortality	Review data on ammonia toxicity vs. pH for affected species, compare to ambient conditions	To be completed in 2019 for inclusion in Year 2 report.
Daily temperature peaks in isolated pools cause or contribute to fish and/or crayfish mortality	Continuous monitoring of temperature, comparison of conditions at the time of a mortality event to stressful and lethal thresholds	Temperature monitoring performed in 2018.

5. REFERENCES

CCCWP. 2018. Contra Costa Clean Water Program, Marsh Creek Stressor Source Identification Study Work Plan. June 2018.

City of Brentwood. 2016. 2015 Urban Water Management Plan. Prepared by Brown and Caldwell on behalf of the City of Brentwood. June, 2016, Brentwood, CA. Available at <https://www.brentwoodca.gov/civicax/filebank/blobdload.aspx?BlobID=34041>, last accessed 12/17/2018.

Grow, L. and Merchant, H. 1980. The burrow habitat of the crayfish, *Cambarus diogenes diogenes* (Girard). American Midland Naturalist, pp.231-237.

Natural Heritage Institute. 2007. The Past and Present Condition of the Marsh Creek Watershed. Fourth Edition. Prepared by the Natural Heritage Institute and the Delta Science Center at Big Break. San Francisco, California, April 2007. Available at https://n-h-i.org/wp-content/uploads/2017/02/Marsh-Creek-Watershed-Report_2007.pdf, last accessed 12/17/2018.

SFRWQCB. 2015. Water Quality Control Plan (Basin Plan) for the San Francisco Bay Basin. San Francisco Regional Water Quality Control Board. March 2015. Available at http://www.waterboards.ca.gov/sanfranciscobay/basin_planning.shtml, last accessed 12/17/2018.

Westhoff, J.T. and Rosenberger, A.E. 2016. A global review of freshwater crayfish temperature tolerance, preference, and optimal growth. Reviews in fish biology and fisheries, 26(3), pp.329-349.

This page intentionally blank

Appendix 5

Pollutants of Concern Monitoring Report: Water Year 2018 Sampling and Analysis

This page intentionally blank

Contra Costa Clean Water Program

Pollutants of Concern Monitoring Report: Water Year 2018 Sampling and Analysis

March 27, 2019



Contra Costa Clean Water Program
255 Glacier Drive
Martinez, California 94553
Tel (925) 313-2360 • Fax (925) 313-2301
www.ccleanwater.org

This page intentionally blank.

Contra Costa Clean Water Program

Pollutants of Concern Monitoring Report: Water Year 2018 Sampling and Analysis

March 27, 2019

Prepared for

Contra Costa Clean Water Program
255 Glacier Drive
Martinez, California 94553

Contra Costa Clean Water Program Participants

- Cities of: Antioch, Brentwood, Clayton, Concord, Danville (Town), El Cerrito, Hercules, Lafayette, Martinez, Moraga (Town), Oakley, Orinda, Pinole, Pittsburg, Pleasant Hill, Richmond, San Pablo, San Ramon, and Walnut Creek
- Contra Costa County
- Contra Costa County Flood Control & Water Conservation District

Prepared by

ADH Environmental
3065 Porter Street, Suite 101
Soquel, California 95073

This page intentionally blank.

TABLE OF CONTENTS

List of Tables	i
List of Figures	i
Acronyms and Abbreviations	iii
1. Introduction.....	1
2. Stormwater Sampling and Analysis for PCBs.....	3
3. BMP Effectiveness – Influent/Effluent Monitoring	5
4. Copper and Nutrients Monitoring.....	7
5. Summary of Monitoring Completed in Water Year 2018	9
6. Quality Assurance / Quality Control Analysis.....	11
7. References.....	13

List of Tables

Table 1. PCB Monitoring Results – Meeker Slough and Metal Recycling Facility (Water Year 2018)	3
Table 2. Stormwater Analytical Tests, Methods, Reporting Limits, and Holding Times	4
Table 3. Mercury and Methylmercury Monitoring Results – Cutting Boulevard (Water Year 2018)	5
Table 4. Copper and Nutrients Monitoring Results – Lower Marsh Creek and Lower Walnut Creek (Water Year 2018)	7
Table 5. Watershed Characterization Analytical Tests, Methods and Reporting Limits – Copper and Nutrients.....	8
Table 6. Summary of Monitoring Completed in Water Year 2018 by Pollutant Class, Analyte, and MRP Targets	9

List of Figures

Figure 1. Location of Water Year 2018 Monitoring Activities – County Overview	10
---	----

This page intentionally blank.

Acronyms and Abbreviations

BASMAA	Bay Area Stormwater Management Agencies Association
Bay	San Francisco Bay
Bay Area	San Francisco Bay Area
BMP	best management practice
CCCWP	Contra Costa Clean Water Program
CVRWQCB	Central Valley Regional Water Quality Control Board
Delta	Sacramento-San Joaquin River Delta
EPA	U.S. Environmental Protection Agency
HDS	hydrodynamic separator
MRP	municipal regional stormwater permit
MS4	municipal separate storm sewer system
NPDES	National Pollutant Discharge Elimination System
PCBs	polychlorinated biphenyl congeners
POC	pollutants of concern
ppb	parts per billion
PSD	particle size distribution
RMP	Regional Monitoring Program for Water Quality in San Francisco Bay
SFRWQCB	San Francisco Bay Regional Water Quality Control Board
SSC	suspended sediment concentration
TMDL	total maximum daily load
TOC	total organic carbon

This page intentionally blank.

1. INTRODUCTION

This report summarizes pollutants of concern (POC) monitoring conducted by Contra Costa Clean Water Program (CCCWP) during water year 2018 (October 1, 2017 through September 30, 2018). This report fulfills Provision C.8.h.iv of the Municipal Regional Stormwater Permit (MRP 2.0, Order R2-2015-0049) issued in 2015 by the San Francisco Bay Regional Water Quality Control Board (SFRWQCB, 2015).

CCCWP Permittees prioritize monitoring pollutants of concern with the goal of identifying reasonable and foreseeable means of achieving load reductions of pollutants required by total maximum daily loads (TMDLs). TMDLs are watershed plans to attain water quality goals developed and established by the San Francisco Bay Regional Water Quality Control Board. The two most prominent TMDLs in driving stormwater monitoring, source control, and treatment projects under MRP 2.0 are the mercury TMDL and the polychlorinated biphenyl congeners (PCBs) TMDL. In the interest of protecting the beneficial uses of the surface waters for people and wildlife dependent on San Francisco Bay (the Bay) for food, these regulatory plans are intended to reduce concentrations of mercury and PCBs in fish within the Bay.

Mercury and PCBs tend to bind to sediments. The principal means of transport from watersheds is via sediments washed into the Municipal Separate Storm Sewer System (MS4); therefore, an important focus of POC monitoring is identifying the most significant sources of contaminated sediments to the MS4. An additional focus is quantifying the effectiveness of control measures. The highest POC monitoring priorities for Permittees are answering these two basic TMDL implementation questions: where are the most significant sources of pollutants of concern, and what can be done to control them?

During water year 2018, the following monitoring activities were completed:

- Stormwater sampling for PCBs in the City of Richmond in two general locations:
 - Adjacent to a private metals recycling facility
 - In MS4 discharge to Meeker Slough
- Best management practice (BMP) effectiveness (influent/effluent monitoring) of two biofiltration cells in the City of Richmond for mercury and methylmercury in stormwater
- Stormwater sampling for copper and nutrients in lower Walnut Creek and lower Marsh Creek

All monitoring activities were performed in accordance with CCCWP's Pollutants of Concern Sampling and Analysis Plan and Quality Assurance Project Plan draft guidance documents (ADH and AMS, 2016a; ADH and AMS, 2016b). Each of these monitoring efforts is described in the following sections.

Additional monitoring information, background and context, including a discussion of permit-driven goals, can be found in the pollutants of concern report for water year 2018 (CCCWP, 2018a).

This page intentionally blank.

2. STORMWATER SAMPLING AND ANALYSIS FOR PCBS

Stormwater samples for water year 2018 were collected in the City of Richmond from the following locations, for the following reasons:

- Street runoff flowing to an MS4 drop inlet adjacent to a private metals recycling facility which was previously known to contribute PCBs to the local MS4 and is suspected of continuing to do so, primarily by means of vehicular trackout. Sampling and analysis were performed to test whether the property owner’s enhanced operation and maintenance procedures mitigated the release of PCBs from the property to acceptable levels.
- Two locations of MS4 discharge in the west portion of Meeker Slough to test whether urban runoff from the City of Richmond contributes substantial concentrations of PCBs to the slough. Meeker Slough is known to have some of the highest concentrations of PCBs in sediment and water in the Bay. It is in the interest of the City of Richmond to build a body of evidence showing current-day discharges to Meeker Slough do not contribute to elevated levels of PCBs, as well as to identify if there may be source properties upstream which might be loading to the slough through the City’s MS4.

Table 1 provides site IDs, sampling dates, position coordinates and analytical results for each location. Table 2 provides analytical test methods, reporting limits and holding times. Refer to Figure 1 for the general locations of these sites.

Table 1. PCB Monitoring Results – Meeker Slough and Metal Recycling Facility (Water Year 2018)

Site ID ¹	MKS-1	MKS-2	SIMS-DI	SIMS-DI	SIMS-DI
Date Sampled	03/20/2018		03/01/2018	03/20/2018	04/06/2018
Latitude (decimal deg.)	37.91486	37.91458	37.92516		
Longitude (decimal deg.)	-122.34386	-122.34186	-122.36613		
Total PCBs ² (pg/L)	18100	12100	99800	96700	550000
Total Hg (ug/L)	0.038	0.027	0.97	0.63	2.1
SSC (mg/L)	59	105	231	182	298
Total Organic Carbon (mg/L)	3.4	4.7	10	4.7	5.7
PCBs/SSC Ratio (ppb) ³	307	115	432	531	1846

1 Site ID key: MKS-1 = MS4 Discharge to Meeker Slough MKS-2 = MS4 Discharge to Meeker Slough SIMS-DI = Richmond Metal Recycling Facility
 2 PCBs in stormwater matrix analyzed by method EPA 1668
 3 Values in **bold italics** indicate a likely high source area for PCBs

Table 2. Stormwater Analytical Tests, Methods, Reporting Limits, and Holding Times

Sediment Analytical Test	Method	Target Reporting Limit	Holding Time
Total PCBs (RMP 40 congeners) ¹	EPA 1668C	0.1 µg/kg	1 year
Total Mercury	EPA 1631E	0.5 ng/L	28 days
Total Methylmercury	EPA 1630	0.1 ng/L	28 days
Suspended Sediment Concentration	ASTM D 3977-97	1.5 mg/L	7 days
Total Organic Carbon (TOC)	EPA 9060	0.50 mg/L	28 days

1 San Francisco Bay RMP 40 PCB congeners include PCB-8, 18, 28, 31, 33, 44, 49, 52, 56, 60, 66, 70, 74, 87, 95, 97, 99, 101, 105, 110, 118, 128, 132, 138, 141, 149, 151, 153, 156, 158, 170, 174, 177, 180, 183, 187, 194, 195, 201, and 203.

2 Particle size distribution by the Wentworth scale; percent fines (slit and clay) are less than 62.5 microns.

3. BMP EFFECTIVENESS – INFLUENT/EFFLUENT MONITORING

BMP effectiveness monitoring for mercury, methylmercury and suspended sediment concentration (SSC) was conducted at two adjacent pilot biofiltration BMPs (LAU3 and LAU4) on Cutting Boulevard in the City of Richmond. These BMPs were selected for monitoring to continue an evaluation of how bioretention affects methylmercury. That effectiveness evaluation is part of a methylmercury control study required by the CVRWQCB. The motivation to continue monitoring was that one of the bioretention cells monitored appeared to increase mercury methylation within the media, but the effect seemed to diminish after the first three or four storms. The extended monitoring was intended to understand whether that decrease of mercury methylation in the problem cell was consistent over time, or whether it increased again. PCBs were not analyzed in these follow-up samples because sufficient effectiveness information was developed for PCBs at that location.

The two biofiltration cells, LAU3 and LAU4, are very similar in construction, except LAU4 contains engineered soil amended with biochar. Both biofiltration cells are flooded with tidal water from the Bay when tidal elevations exceed approximately 5.0 feet mean lower low water. The cell where increased mercury methylation was observed, LAU3, has a lower invert elevation than LAU4, and is therefore inundated with tidal water more often and for longer periods compared to LAU4. It is suspected that either wet/dry cycling of the biofiltration cells, and/or the introduction of sulfate, both due to periodic tidal inflow may influence mercury methylation within the BMP.

Results from water year 2018 monitoring are summarized in Table 3. In a larger context, results of all methylmercury sampling from these biofiltration BMPs were compiled, analyzed and reported in the Methylmercury Control Study Final Report (CCCWP, 2018b).

Table 3. Mercury and Methylmercury Monitoring Results – Cutting Boulevard (Water Year 2018)

Site ID ¹	LAU3-I		LAU3-E		LAU4-I		LAU4-E	
Sample Date	03/01/2018	04/06/2018	03/01/2018	04/06/2018	03/01/2018	04/06/2018	03/01/2018	04/06/2018
Sample Time	08:40	07:45	08:45	07:50	08:20	07:55	08:25	08:00
Latitude (degrees)	37.92536		37.92536		37.92536		37.92536	
Longitude (degrees)	-122.36981		-122.36977		-122.36931		-122.36934	
Mercury (µg/L)	0.017	0.025	0.077	0.028	0.09	0.061	0.1	0.03
Methylmercury (ng/L)	0.13	0.12	0.38	1.3	0.21	0.24	0.4	0.22
SSC (mg/L)	9.9	71	13	2.8	65	25	172	54
MeHg/Hg Ratio (%)	0.8	0.5	0.5	4.6	0.2	0.4	0.4	0.7

¹ Site ID key:

LAU3-I = Biofiltration Cell 3 Influent LAU3-E = Biofiltration Cell 3 Effluent LAU4-I = Biofiltration Cell 4 Influent LAU4-E = Biofiltration Cell 4 Effluent

MeHg Methylmercury

This page intentionally blank.

4. COPPER AND NUTRIENTS MONITORING

Copper and nutrients samples were collected during one storm at Walnut Creek and Marsh Creek. The sampling sites were located in the lower reach of each creek but upstream of tidal influences, and represent discharge to the Bay/Delta from the two largest watersheds in the county. For Marsh Creek, the site was co-located with the fixed monitoring station for water years 2012-2014, which is approximately 0.2 miles upstream of the City of Brentwood’s wastewater treatment plant discharge. This site was selected because past data for copper and nutrients can be compared to current results to address trends. For Walnut Creek, the site was co-located with an MRP Provision C.8.d creek status probabilistic monitoring site. This site was selected because monitoring efforts under the creek status monitoring program may provide an opportunity for trends assessment.

One grab sample was collected near peak flow from each creek during the storm of March 1, 2018. Samples were filtered in the field within 15 minutes of collection for dissolved copper, ammonia, nitrate, nitrite, and orthophosphate. Refer to Table 4 for position coordinates and a summary of analytical results. Refer to Table 5 for test methods and reporting limits.

Table 4. Copper and Nutrients Monitoring Results – Lower Marsh Creek and Lower Walnut Creek (Water Year 2018)

Site ID ¹	LMC	WAL
Sample Date	03/01/2018	03/01/2018
Sample Time	1120 ^a	1000 ^a
Latitude (decimal degrees)	37.96264	37.97271
Longitude (decimal degrees)	-121.68794	-122.05305
Copper, Dissolved (µg/L)	3.2	3
Copper, Total (µg/L)	3.5	10
Hardness (mg/L)	180	120
Ammonia as N (mg/L)	<0.1	<0.1
Nitrate (mg/L)	0.73	0.28
Nitrite (mg/L)	0.025 J	0.005 J
Total Kjeldahl Nitrogen (mg/L)	1.1	1.5
Dissolved Orthophosphate (mg/L)	0.03	0.16
Phosphorus (mg/L)	0.069	0.37

¹ Site ID key: LMC = Lower Marsh Creek WAL = Lower Walnut Creek

^a Near peak of hydrocurve

< Analyte not detected at or above the detection limit; numeric value after the “<” symbol is the value of the detection limit

J Analyte detected below the reporting limit; result should be considered as an estimated value

Table 5. Watershed Characterization Analytical Tests, Methods and Reporting Limits – Copper and Nutrients

Analytical Test	Method	Target Reporting Limit
Suspended Sediment Concentration (SSC)	ASTM D 3977-97B	3 mg/L
Copper, total recoverable and dissolved	EPA 200.8	0.5 µg/L
Hardness	SM 2340C (titration)	5 mg/L
Ammonia as N	SM 4500-NH3 C v20	0.1 mg/L
Nitrate	EPA 300.0	0.05 mg/L
Nitrite	EPA 300.0	0.05 mg/L
Total Kjeldahl Nitrogen	SM 4500 NH3-C	0.1 mg/L
Dissolved Orthophosphate	SM 4500P-E	0.01 mg/L
Total Phosphorus	SM 4500P-E	0.01 mg/L

5. SUMMARY OF MONITORING COMPLETED IN WATER YEAR 2018

Water year 2018 monitoring is summarized in Table 6. The table lists the total number of tests completed for each pollutant class, and the corresponding targets outlined in MRP 2.0.

The number of samples collected and analyzed in water year 2018 met or exceeded the minimum annual requirements of the MRP in all pollutant categories, with the exception of emerging contaminants which will be sampled and analyzed in one special study before the end of the five-year permit term.

Table 6. Summary of Monitoring Completed in Water Year 2018 by Pollutant Class, Analyte, and MRP Targets

Pollutant Class / Type of Monitoring	Analyte									Agency or Organization Performing the Monitoring	Number of Samples Collected and Analyzed in WY 2018	Cumulative Number of Samples Collected and Analyzed in WYs 2016-2018	Total Number of Samples Required by the MRP Over 5-Year Term
	PCBs	Mercury	Methylmercury	SSC	PSD	TOC	Copper ¹	Hardness	Nutrients ²				
PCBs - water	✓			✓		✓				CCCWP	5	77	80
PCBs - water	✓			✓		✓				RMP	4		
PCBs - water	✓			✓		✓				BASMAA	6 ^a		
PCBs - sediment	✓				✓	✓				BASMAA	5 ^b		
PCBs - sediment	✓				✓	✓				BASMAA	2 ^c		
Mercury - water		✓	✓	✓		✓				CCCWP	13	103	80
Mercury - water		✓	✓	✓		✓				RMP	4		
Mercury - water		✓	✓	✓		✓				BASMAA	6 ^a		
Mercury - sediment		✓			✓	✓				BASMAA	8 ^c		
Copper - water							✓	✓		CCCWP	2	6	20
Nutrients – water									✓	CCCWP	2	6	20
Emerging Contaminants ³										-	0	0	3

1 Total and dissolved fractions of copper

2 Nutrients include: ammonia, nitrate, nitrite, total Kjeldahl nitrogen, orthophosphate and total phosphorus

3 Emerging contaminants (alternative flame retardants) need only be tested during one special study over the 5-year term of the permit

a Laboratory column experiments of various soil media filtrate samples collected and analyzed under BASMAA regional project; 25 samples total of which CCCWP takes credit for 6 (25 percent of total)

b Caulk/sealant samples collected and analyzed under BASMAA regional project; 20 samples total of which CCCWP takes credit for 5 (25 percent of total)

c HDS sediment samples collected and analyzed under BASMAA regional project; 8 samples total of which CCCWP takes credit for 2 (25 percent of total)

SSC suspended sediment concentration

PSD particle size distribution

TOC total organic carbon

WY water year

Figure 1. Location of Water Year 2018 Monitoring Activities – County Overview

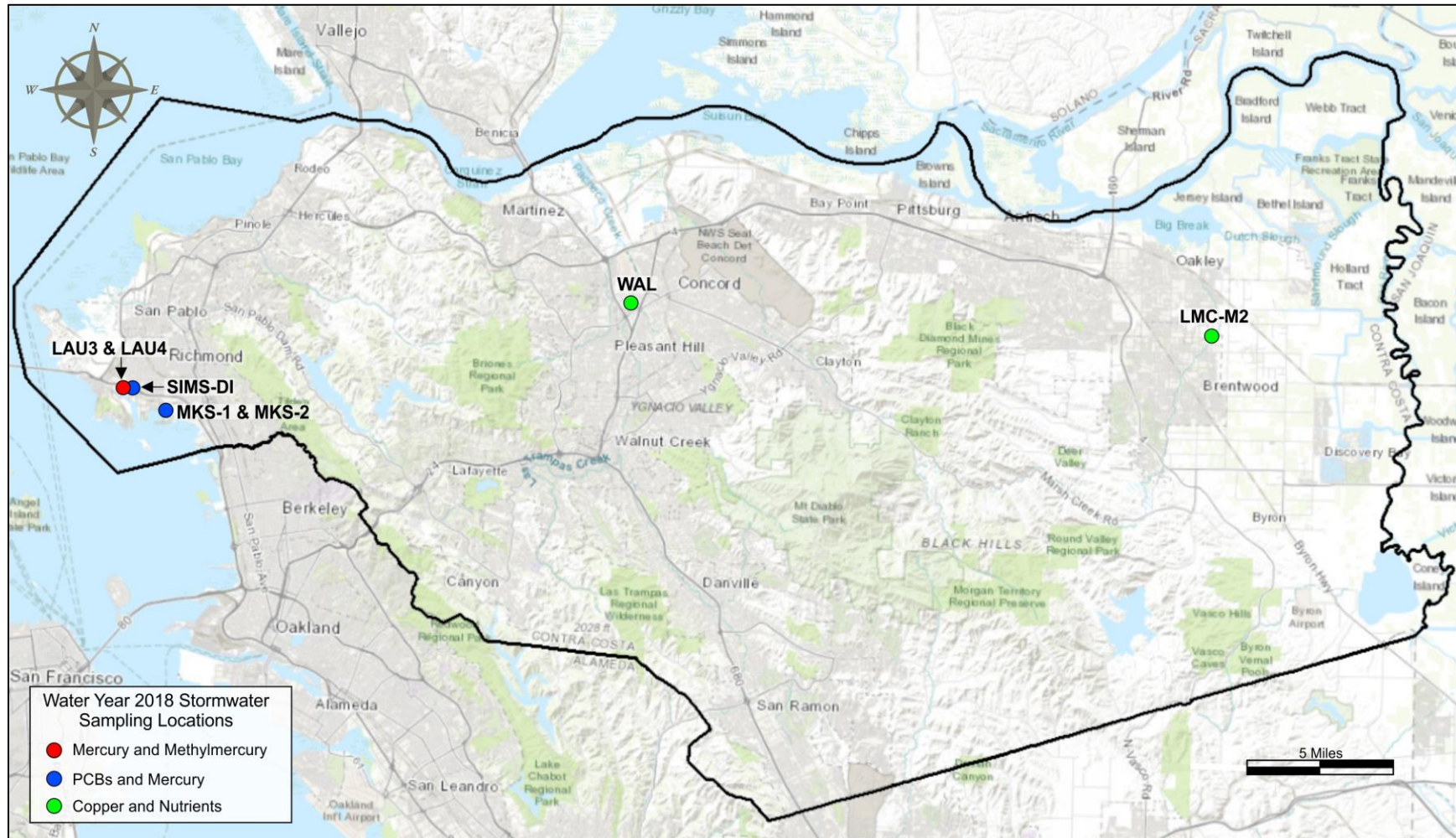

6. QUALITY ASSURANCE / QUALITY CONTROL ANALYSIS

ADH performed verification and validation of all laboratory data per the project QAPP (draft) and consistent with 2013 SWAMP measurement quality objectives.

Overall, the PCB congener data from ALS were acceptable. EPA 1668 C methods for PCBs recommend analysis within a year, and all samples were analyzed well within that time. MDLs were sufficient with no non-detects reported for any of the PCB congeners measured. Some contamination was found in the laboratory blanks for two of the more abundant congeners, but at concentrations less than 1 percent of the average found in the field samples. Several target PCB congeners, and numerous non-target congeners, were reported in laboratory control samples to evaluate accuracy, with good recovery (average error on target compounds always less than 15 percent, well within the target MQO of 35 percent). Two target congeners (PCB 187 and 153/168) were reported with both elevated accuracy and precision; these samples and any other samples out of range have been flagged appropriately in the data.

All samples for all analyses met laboratory quality control objectives, except for instances shown in Table 6. Given that all the quality control issues described in Table 6 show the issues were of relatively minor consequence, the data from these samples are of acceptable quality and are included in the data set for this annual report.

Table 6. Quality Control Issues and Analysis in the WY 2018 Project Data Set

Sample ID & Type	Issue	Analysis
Laboratory Blanks EQ1800113-01 EQ1800134-01	Several of the PCB congeners had low level hits in the Lab Blank.	Detection in the laboratory blanks were recorded, but at concentrations <1% of the average found in the field samples. All analytical data results were flagged appropriately; no further action required.
Laboratory Control Samples EQ1800146-03 EQ1800164-03	The RPD matrix spike duplicate of a few PCB congeners were above 25 percent.	The control criteria for the RPDs of these analytes was not applicable. Based on the magnitude of background contribution, the interference appeared to be minimal. No further corrective action was appropriate other than flagging the affected results.
Laboratory Control Samples EQ1800113-02, 03 EQ1800146-02, 03 EQ1800164-02, 03	The recovery of a few PCB congeners in a matrix spike sample was outside the project control limits.	Recovery in the LCS was acceptable, which indicated the analytical batch was in control. No further corrective action was appropriate other than flagging the affected results.
Laboratory Control Samples EQ1800113-02, 03 EQ1800146-02, 03 EQ1800164-02, 03	Insufficient sample volume available to follow standard quality control for PCBs.	The laboratory did not have sufficient field sample volumes to run MS/MSD as required by method. LCS/LCSD were run by the laboratory in lieu of MS/MSD. All analytical results were flagged appropriately.
Field Sample K1802684-001 Laboratory Blank EQ1800146-01	The ion abundance ratios did not meet the acceptance criteria for some PCB congeners in some samples.	Reported value is an estimated maximum. All analytical results were flagged appropriately; no further action required.

LCS laboratory control sample
 LCSD laboratory control sample duplicate
 MS matrix spike
 MSD matrix spike duplicate
 RPD relative percent difference

This page intentionally blank.

7. REFERENCES

- ADH and AMS. 2016a. Contra Costa County Clean Water Program, Sampling and Analysis Plan DRAFT, Pollutants of Concern Monitoring; Pesticides and Toxicity Monitoring. ADH Environmental and Applied Marine Sciences. January 21, 2016.
- ADH and AMS. 2016b. Contra Costa County Clean Water Program, Quality Assurance Project Plan DRAFT, Pollutants of Concern Monitoring; Pesticides and Toxicity Monitoring. ADH Environmental and Applied Marine Sciences. January 26, 2016.
- CCCWP. 2018a. Contra Costa Clean Water Program. Contra Costa Clean Water Program, Pollutants of Concern Report: Accomplishments in Water Year 2018 and Allocation of Effort for Water Year 2019. Prepared by ADH Environmental and Wood Group. October 2018.
- CCCWP. 2018b. Contra Costa Clean Water Program. Contra Costa Clean Water Program, Methylmercury Control Study Final Report. October 2018.
- SFRWQCB. 2015. California Regional Water Quality Control Board, San Francisco Bay Region, Municipal Regional Stormwater NPDES Permit, Order No. R2-2015-0049, NPDES Permit No. CAS612008. November 19, 2015.

This page intentionally blank.

Appendix 6

POC Monitoring for Management Action Effectiveness

- A. Pollutant Removal from Stormwater and Biochar Amended Bioretention Soil Media (BSM) Project Report***
- B. Evaluation of Mercury and PCBs Removal Effectiveness of Full Trash Capture Hydrodynamic Separator Units, Project Report***

This page intentionally blank

Pollutant Removal from Stormwater with Biochar Amended Bioretention Soil Media (BSM)

Project Report



Prepared for:

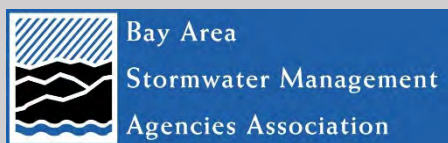

Prepared by:

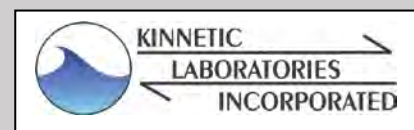

Final

February 8, 2019

DISCLAIMER

Information contained in Bay Area Stormwater Management Agencies Association (BASMAA) products is to be considered general guidance and is not to be construed as specific recommendations for specific cases. BASMAA is not responsible for the use of any such information for a specific case or for any damages, costs, liabilities or claims resulting from such use. Users of BASMAA products assume all liability directly or indirectly arising from use of the products.

The mention of commercial products, their source, or their use in connection with information in BASMAA products is not to be construed as an actual or implied approval, endorsement, recommendation, or warranty of such product or its use in connection with the information provided by BASMAA.

This disclaimer is applicable to all BASMAA products, whether information from the BASMAA products is obtained in hard copy form, electronically, or downloaded from the Internet.

TABLE OF CONTENTS

LIST OF FIGURES.....	iv
LIST OF TABLES.....	v
LIST OF ACRONYMS.....	vi
EXECUTIVE SUMMARY	1
Methods.....	1
Results.....	2
Conclusions	2
Recommendations	3
1 INTRODUCTION.....	4
1.1 Background	4
1.2 Study Goals	5
2 METHODS.....	7
2.1 Study Approach.....	7
2.2 Initial Media Selection and Blends.....	7
2.3 Biochar Selection	7
2.4 Hydraulic Testing.....	7
2.5 Column Setup and Seasoning Runs.....	8
2.6 Stormwater Collection	9
2.7 Sampling Runs.....	10
2.8 Constituents and Laboratory Methods.....	12
2.9 Analysis and Statistical Testing	12
3 RESULTS.....	13
3.1 Biochar Characteristics, Hydraulic Conductivity, and Selection	13
3.2 Quality Assurance and Quality Control.....	14
3.2.1 PCBs.....	14
3.2.2 Total Mercury (Hg), TOC, and SSC.....	14
3.3 Column Test Runs	15
3.3.1 PCBs.....	16
3.3.2 Mercury.....	24
3.3.3 Other Constituents.....	26
3.4 Statistical Tests.....	30

4	CONCLUSIONS AND RECOMMENDATIONS.....	30
4.1	Conclusions	31
4.2	Recommendations	31
4.2.1	Biochar Selection.....	32
4.2.2	Site Selection.....	32
4.2.3	Outlet Control	32
4.2.4	Saturated Hydraulic Conductivity Testing Requirements	32
5	REFERENCES	33
	Appendix A: Monitoring Study Design	A-1
	Appendix B: Sampling and Analysis Plan and Quality Assurance Project Plan	B-1
	Appendix C: Proposed Biochar Selection Factors	C-1
	Appendix D: Hydraulic Test Results	D-1
	Appendix E: Biochar Particle Size Distribution.....	E-1
	Appendix F: Column Test Observation Forms.....	F-1
	Appendix G: Water Quality Data.....	G-1

LIST OF FIGURES

Figure 1. Cumulative Frequency Distribution of Total PCB Influent Concentrations for Bioretention Media with and without Biochar from CW4CB (BASMAA, 2017a)	5
Figure 2. Column test setup at Sacramento State showing five of six columns	8
Figure 3. Teflon Column Cap with Drainage Veins and Holes (left) and Stainless Steel Throttling Screws (right)	9
Figure 4. Column Test Setup	11
Figure 5. Total PCB Concentrations over Time	17
Figure 6. Observed Total PCB Concentrations for Undiluted Influent Runs and Column Test Media Effluent.....	19
Figure 7. Ce/Ci Total PCB Concentrations for Column Test Media.....	20
Figure 8. Total PCB Concentrations for CW4CB Pilot Sites Influent, Undiluted Influent Runs, CW4CB BSM Effluent, and Column Test BSM Effluent, CW4CB Biochar-amended Effluent, and Column Test Biochar-amended Effluent	21
Figure 9. Ce/Ci Total PCB Concentrations for CW4CB Pilot Sites and All Biochar Test Media	22
Figure 10. Ce/Ci Total PCB Concentrations for CW4CB Biochar Pilot Site and BioChar Solutions Test Media	23
Figure 11. Total PCB Concentrations for all Study Effluent versus Influent	24
Figure 12. Mercury Concentrations over Time	25
Figure 13. Comparison of Total PCB to SSC Concentrations.....	27
Figure 14. Comparison of Mercury to TOC Concentrations.....	28
Figure 15. Ce/Ci TOC Concentrations for Column Test Media.....	28
Figure 16. Ce/Ci SSC Concentrations for Column Test Media.....	29
Figure 17. Average Turbidity versus Consecutive Hydraulic Loading (Sampling Runs are labeled 1, 3, 4, 5, and 6 and Seasoning Loading are labeled 2 and 3).....	30

LIST OF TABLES

Table 1. Selected Aqueous Constituents for Media Testing in Laboratory Columns	12
Table 2. Characteristics for Biochar Considered for Water Quality Testing	13
Table 3. Influent Descriptions, PCB and Mercury Concentrations, and Columns Dosed for each Sampling Run	15
Table 4. Infiltration Rates and PCB, Mercury, TOC, and SSC Results for each Sampling Run.....	16

LIST OF ACRONYMS

BASMAA	Bay Area Stormwater Management Agencies Association
BMP	Best Management Practices
BSM	Bioretention Soil Media
CW4CB	Clean Watersheds for a Clean Bay
DQO	Data Quality Objective
EPA	Environmental Protection Agency
In/hr	Inches per hour
KLI	Kinnetic Laboratories, Inc.
K_{sat}	Saturated Hydraulic Conductivity
LCS	Laboratory Control Sample
MDD	Maximum Dry Density
MDL	Method Detection Limit
MQO	Measurement Quality Objectives
MRP	Municipal Regional Permit
MS/MSD	Matrix Spike/Matrix Spike Duplicate
MS4	Municipal Separate Storm Sewer System
ND	Non-detect
NPDES	National Pollutant Discharge Elimination System
OWP	Office of Water Programs
PCBs	Polychlorinated Biphenyls
PG&E	Pacific Gas and Electric Company
PMT	Project Management Team
POC	Pollutants of Concern
ppb	parts per billion
ppm	parts per million
QA/QC	Quality Assurance/Quality Control
QAPP	Quality Assurance Project Plan
RL	Reporting Limit
RMP	Regional Monitoring Program
RPD	Relative Percent Difference
SAP	Sampling and Analysis Plan
SFEI	San Francisco Estuary Institute
SSC	Suspended Sediment Concentration

TMDL Total Maximum Daily Loads
TOC Total Organic Carbon

EXECUTIVE SUMMARY

The Bay Area Stormwater Management Agencies Association (BASMAA) implemented this regional study to evaluate the effectiveness of biochar-amended bioretention soil media (BSM) to remove polychlorinated biphenyls (PCBs) and mercury from stormwater collected from storm drains within the area covered by the Municipal Regional Permit (MRP; Order R2-2015-0049)¹ that are known to be impacted by diffuse PCB sources. The MRP requires that permittees² provide information to support the implementation of the wasteload allocations for mercury and PCB total maximum daily loads (TMDLs) as described in MRP Provisions C.11 and C.12. This study also contributes to implementation of MRP Provision C.8.f (Pollutant of Concern (POC) Monitoring) Priority #3, “Management Action Effectiveness,” which focuses on monitoring the effectiveness of specific management actions in reducing or avoiding loads of mercury and PCBs in municipal separate storm sewer system (MS4) discharges.

A prior BASMAA study, the Clean Watershed for a Clean Bay (CW4CB) project, found that BSM amended with biochar substantially improved PCBs removal compared to the standard BSM specified in MRP Provision C.3 at the same location (BASMAA 2017). The BSM contained 60 percent sand and 40 percent compost. The amended BSM contained 75 percent BSM and 25 percent biochar, which equates to 45 percent sand, 30 percent compost, and 25 percent biochar. Only one biochar source was tested, so it was unknown whether there would be substantial performance differences among differing biochar sources.

The goal of this study was to identify biochar media amendments that improve PCB and mercury load removal by bioretention BMPs. The primary management question supporting that goal was: “Are there readily available biochar-amended BSM that provide significantly better PCB and mercury load reductions than standard BSM and meet MRP infiltration rate requirements?” And the particular purpose of the laboratory testing in this study was: “screen alternative biochar-amended BSM and identify the most promising for further field testing.” (Monitoring Study Design, Appendix A)

The study was carried out by a project team comprised of the Office of Water Programs at Sacramento State (OWP), EOA Inc., Kinetic Laboratories, Inc. (KLI), the San Francisco Estuary Institute (SFEI), and ALS Environmental (ALS). A BASMAA project management team (PMT) consisting of representatives from BASMAA stormwater programs and municipalities provided oversight and guidance to the project team throughout the monitoring study. Stormwater was collected in March and April of 2018, and the BSM testing was conducted in April and May of 2018.

METHODS

This study compared the removal of PCBs and mercury from stormwater in laboratory column tests of five locally-available biochars produced from a variety of feedstock and methods admixed at a 1-to-3 ratio by volume with BSM. The biochars used in this study were compared against each other and against a standard BSM. Due to availability, the BSM contained 65 percent sand and 35 percent

1 http://www.waterboards.ca.gov/sanfranciscobay/water_issues/programs/stormwater/Municipal/R2-2015-0049.pdf

2 A total of 76 cities, towns, unincorporated counties, and flood control and water conservation districts covered by the MRP.

compost, which is still within the acceptable range specific in the MRP Provision C.3 and the BASMAA specification (BASMAA 2016). The BSM-biochar blend ratio matched the CW4CB study (75% BSM and 25%). The resulting amended BSM contained 49 percent sand, 26 percent compost, and 25 percent biochar. Each of the test biochars was mixed with the standard BSM and placed in 7.5-inch-diameter glass columns to a depth of 18 inches, typical of standard field installations. One additional column was prepared as a control and filled with 18 inches of standard BSM. The stormwater used for all tests was collected during two storms from two sites that were located in the portion of the San Francisco Bay Area subject to the MRP and that had previously observed elevated levels of PCBs. Four sampling runs were performed on the columns, three runs using undiluted stormwater on all columns and the fourth run using stormwater diluted at a one-to-nine ratio to test removal effectiveness at lower influent concentrations on two³ columns. Column influent and effluent samples were collected during each test run and analyzed for PCBs, total mercury, total organic carbon (TOC), suspended solids concentration (SSC), and turbidity.

RESULTS

Influent concentrations of PCBs (9,860 to 19,600 picograms/liter or pg/L) were consistent with samples previously taken at the sampling sites during the CW4CB study (BASMAA 2017). The standard BSM control column had effluent concentrations of PCBs similar to the standard BSM tested alongside biochar in the CW4CB study. Two of the five biochar-amended BSM columns, Phoenix and Agrosorb, exhibited lower effluent concentrations of PCBs than the standard BSM column for all test runs. A third column, BioChar Solutions, produced three effluents with lower concentrations and a single effluent sample at a slightly higher concentration than that produced by the standard BSM. The remaining two biochar-amended BSM columns had one or two effluent samples that were much higher than those from the standard BSM, and one sample showed a substantial export of PCBs. However, these high PCB concentrations corresponded to unusually high infiltration rates compared to the testing conditions for all other data, suggesting channelizing or otherwise insufficient compaction of media within the column and so these data are not used in analysis and graphs. The remaining results collected for those two biochars under typical infiltration conditions exhibited PCB removal, and at least half of those results were superior to BSM.

Mercury influent concentrations (9.9-10.2 ng/L) were very similar across all samples. Mercury removal across all test runs occurred in two biochar-amended BSM columns, Phoenix and Agrosorb. The other columns showed variable treatment, including some export of mercury (the worst of which corresponds to a sample removed from the dataset due to abnormally high infiltration rates). The standard BSM column was the only column to export mercury for all test runs.

CONCLUSIONS

All five biochar-BSM blends showed evidence of overall improved PCB and mercury performance compared to the standard BSM. The results support these additional observations:

- Phoenix, Sunriver, BioChar Solutions, and Agrosorb appear to offer improved PCB removal compared to standard BSM and the other biochar-amended BSM.

³ The effluent of one column (CO6) in the dilution run could not be analyzed by the lab at the time of this study report so it is presumed lost.

- Phoenix and Agrosorb appear to offer improved mercury removal compared to standard BSM and the other biochar-amended BSM.
- Biochar may decrease performance variability from variable influent concentrations compared to standard BSM.
- Based on a single run on one column to explore removal at lower influent concentrations, biochar-amended BSM provided removal of PCBs at an influent concentration of 2,100 pg/L. BSM performance at this lower influent concentration could not be reported due to the sample being lost. Neither BSM nor biochar-amended BSM provided removal of mercury at an influent concentration of 3.00 ng/L.
- High initial infiltration rates correlated to poor performance (higher rates are associated with short-circuiting and higher pore velocities).
- Saturated hydraulic conductivity was poorly correlated to the falling head infiltration rates estimated during the water quality sampling runs, so biochars that were eliminated from column testing based on saturated hydraulic conductivity tests may be candidates for future testing.

RECOMMENDATIONS

Based on this study, biochar shows promise in marginally increasing performance; however, increased benefit relative to increased cost was not analyzed. With such limited data, benefit/cost analysis may be more appropriate after collection of substantial field data. Because of the marginal increase in performance, standard BSM should be a component of future side-by-side testing of biochar-amended BSM. If further biochar testing is pursued, the following recommendations should be considered.

If selecting biochar for PCB removal, the best-performing biochars were Phoenix, Sunriver, BioChar Solutions, and Agrosorb. If mercury removal is a design consideration, Phoenix and Agrosorb should be further studied. Because there was no correlation between performance and cost, less costly biochars that were not tested here (including those that were eliminated from this study based on possible inappropriate use of saturated hydraulic conductivity test procedures) might be considered for further field testing alongside one or more biochars from this study.

Site selection should consider the collective experience in this and other studies on irreducible minimum concentrations. This study suggests that value may be around 1,000 pg/L for PCBs. It is unclear for total mercury. Watersheds likely to have concentrations near or below irreducible concentrations should be avoided.

The most substantial enhancement to performance may be the use of outlet controls to increase contact time with biochar-amended BSM. Outlet controls should be considered for further study of both biochar-amended and standard BSM.

And finally, further development of procedures for laboratory tests of hydraulic conductivity or infiltration rate is recommended. Improving correlation between field-measured infiltration rates and laboratory test procedures for hydraulic conductivity may avoid screening out BSM blends and amendments based on tests that do not relate to field conditions.

1 INTRODUCTION

1.1 BACKGROUND

PCBs and mercury are pollutants of concern in the San Francisco Bay Area and removal of both from stormwater runoff using BSM amended with biochar has shown some promise in a previous investigation (BASMAA 2017).

Biochar is a highly porous, granular charcoal produced from a variety of organic materials and primarily marketed as a soil amendment. The majority of biochar research conducted to date has focused on agricultural applications, where biochar has been shown to improve plant growth, soil fertility, and soil water holding, especially in sandier soils. But investigation of stormwater treatment benefit is limited, especially for removal of mercury or PCBs.

A recent laboratory study on the effect of biochar addition to contaminated sediments showed that biochar is one to two orders of magnitude more effective at removing PCBs from soil pore water than natural organic matter, and may be effective at removing methylmercury but not total mercury (Gomez-Eyles et al. 2013). A laboratory column test study to determine treatment effectiveness of 10 media mixtures showed that a mixture of 70% sand/20% coconut coir/10% biochar was one of the top performers and less expensive than similarly effective mixtures using activated carbon (Kitsap County 2015). Liu et al. (2016) tested 36 different biochars for their potential to remove mercury from aqueous solution and found that concentrations of total mercury decreased by >90% for biochars produced at >600°C and by 40–90% for biochars produced at 300°C.

A prior BASMAA study, the CW4CB project (BASMAA 2017), examined whether BSM amended with biochar would substantially improve PCBs removal compared to the standard BSM specified in MRP Provision C.3. In the CW4CB study, the effect of adding a biochar to BSM was evaluated using data collected from two bioretention cells (LAU 3 and LAU 4) that treat roadway runoff just outside the Richmond Pacific Gas and Electric (PG&E) Substation at 1st Street and Cutting Boulevard. At this site, a standard bioretention cell (LAU 3) contains standard BSM (60 percent sand and 40 percent compost) while an enhanced bioretention cell (LAU 4) contains a mix of 75 percent standard BSM and 25 percent pine wood-based biochar (by volume), which equates to 45 percent sand, 30 percent compost, and 25 percent biochar. The results suggest that the addition of biochar to BSM is likely to increase removal of PCBs in bioretention best management practices (BMPs; BASMAA 2017).

Figure 1 shows a cumulative frequency plot of influent and effluent concentrations of PCBs for the two CW4CB bioretention cells. Although influent concentrations at the two cells were generally similar, effluent concentrations were much lower for the biochar enhanced bioretention cell (LAU 4) compared to those for the standard bioretention cell (LAU 3). The results for total mercury were different from those for PCBs, with both cells demonstrating little difference between influent and effluent concentrations. These CW4CB monitoring results suggest that the addition of biochar to BSM may increase removal of PCBs from stormwater. There was little effect on total mercury.

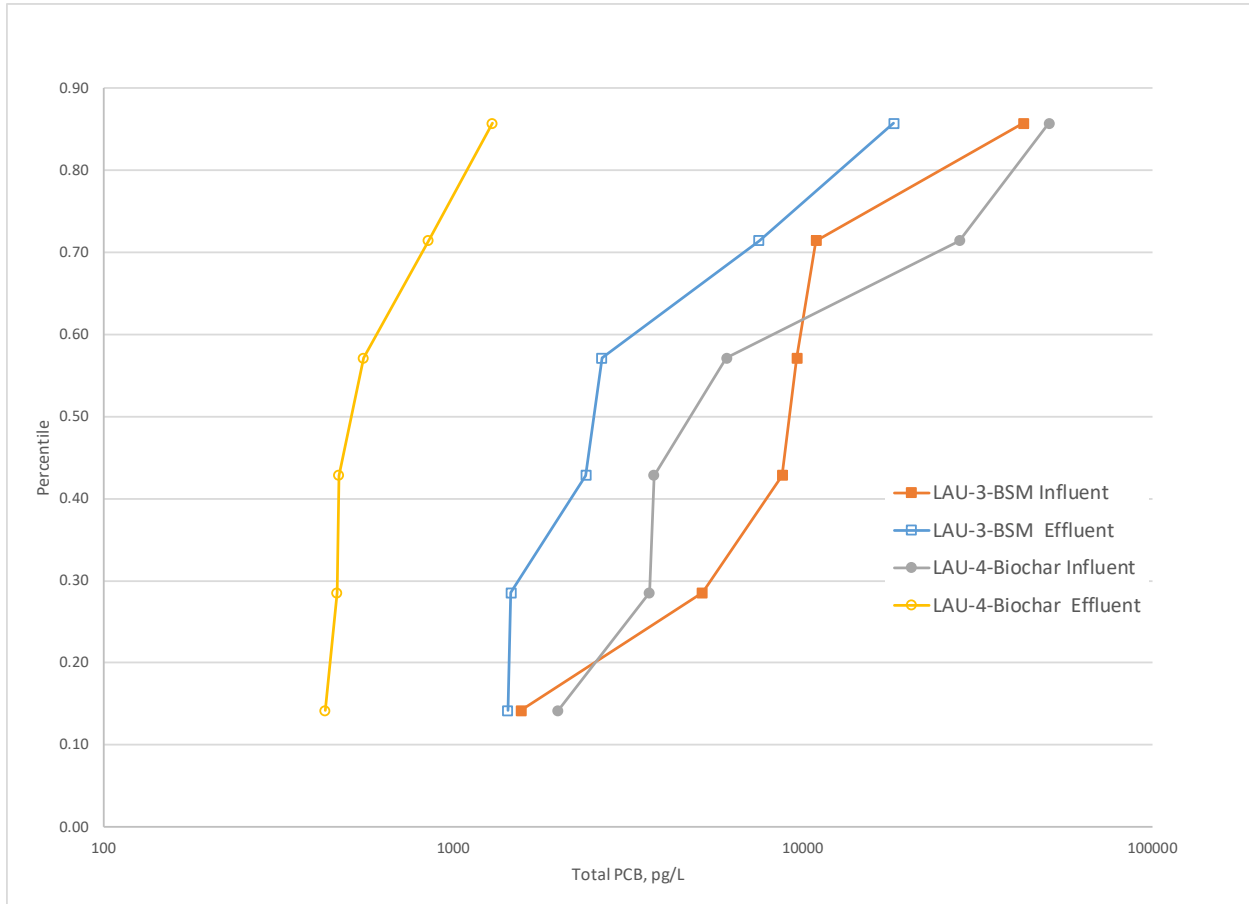

Figure 1. Cumulative Frequency Distribution of Total PCB Influent Concentrations for Bioretention Media with and without Biochar from CW4CB (BASMAA, 2017a)

Monitoring of the two bioretention cells at the CW4CB pilot site showed greater PCBs removal for a biochar-amended BSM than for standard BSM. However, to date, sampling has been limited to one test site and one biochar amendment. Besides the CW4CB study, there are no published literature studies on field PCBs and mercury removal from stormwater using biochars. Additional field testing can confirm the effectiveness of biochar in bioretention, but very little data is available on the selection of biochar for further field study. Laboratory testing of different biochars using actual stormwater from the Bay Area is a cost-effective tool to screen biochar media to identify good candidates for PCBs removal in future field testing.

1.2 STUDY GOALS

The goal of this study, as identified in the Monitoring Study Design (Appendix A), was to identify biochar media amendments that improve PCB and mercury load removal by bioretention BMPs. The primary management question supporting that goal was: “Are there readily available biochar-amended BSM that provide significantly better PCB and mercury load reductions than standard BSM and meet MRP infiltration rate requirements?” And the particular purpose of the laboratory testing in this study was: “screen alternative biochar-amended BSM and identify the most promising for further field testing.”

The MRP requires that permittees provide information to support the implementation of the wasteload allocations for mercury and PCB total maximum daily loads (TMDLs) as described in MRP Provisions C.11 and C.12. This study also contributes to implementation of MRP Provision C.8.f (POC Monitoring) Priority #3, “Management Action Effectiveness,” which focuses on monitoring the effectiveness of specific management actions in reducing or avoiding loads of mercury and PCBs in MS4 discharges.

The MRP infiltration rate requirements are described in Provision C.3.c of the MRP. This provision states: “Biotreatment (or bioretention) systems shall be designed to have a surface area no smaller than what is required to accommodate a 5 inches/hour stormwater runoff surface loading rate, infiltrate runoff through biotreatment soil media at a minimum of 5 inches per hour, and maximize infiltration to the native soil during the life of the Regulated Project.” In addition to the 5 inches per hour MRP requirement, for any application that uses a non-standard BSM, the recently updated BASMAA specification requires “certification from an accredited geotechnical testing laboratory that the bioretention soil has an infiltration rate between 5 and 12 inches per hour” (BASMAA 2016).

To accomplish the purpose of this study, the following tasks were identified:

1. Collect all readily available west coast biochar;
2. Test each biochar-amended BSM and select those for water quality testing that meet infiltration requirements using saturated hydraulic conductivity tests;
2. Compare performance among select media mixes with biochar using influent-effluent column tests with Bay Area stormwater for PCBs and mercury removal;
3. Estimate whether PCBs and mercury reduction can occur at lower concentrations by using influent-effluent column tests for the best mix with diluted Bay Area stormwater

Because the purpose of the study design is to screen biochars for further field testing, the number of samples was spread out over as many biochars as possible while still producing enough data points for each biochar to distinguish large performance differences between biochars and BSM similar to what was observed in the CW4CB study.

This report presents the results of the BSM testing study conducted from March through May, 2018. The study was implemented by a project team comprised of the Office of Water Programs (OWP), EOA Inc., Kinnetic Laboratories, Inc. (KLI), the San Francisco Estuary Institute (SFEI), and ALS Environmental (ALS). A BASMAA project management team (PMT) consisting of representatives from BASMAA stormwater programs and municipalities provided oversight and guidance to the project team throughout the study.

The Methods section explains the study approach and methods used to complete this study. This is followed by the Results section that includes PCBs and mercury removal data. The Conclusions and Recommendations section summarizes the findings of this study and gives brief recommendations for media selection for future field sites. Appendices include the Monitoring Study Plan, Sampling and Analysis Plan and Quality Assurance Project Plan, Proposed Biochar Selection Factors, Hydraulic Test Results, Biochar Particle Size Distribution, and Water Quality Laboratory Reports.

2 METHODS

2.1 STUDY APPROACH

The study approach called for: 1. Gathering biochar products that are readily available locally (west coast) at the time of the study; 2. Collecting product information, including feedstock, pyrolysis temperature; 3. Testing saturated hydraulic conductivity of each biochar blended into standard BSM at a 1-to-3 ratio; 4. Selecting five biochars; and 5. Performing three runs through side-by-side column tests alongside a standard BSM serving as a control using Bay Area stormwater; and 5. Performing a single run on two columns⁴ using diluted Bay Area stormwater. Details and adjustments to this approach are described below.

2.2 INITIAL MEDIA SELECTION AND BLENDS

A total of nine samples from all identified locally available biochar producers were gathered. The samples were mixed at a ratio of one-to-three by volume with standard BSM to match the CW4CB biochar-amended pilot project amendment ratio. All biochars used in this study were unmodified (i.e., the biochars were not sieved, rinsed, or chemically treated in any way; all were used as received from their manufacturers). When blending the biochar-amended BSM, care was taken to use a representative subsample of the biochar. The BSM vendor was L.H.Voss Materials, and the BSM consisted of 65% sand and 35% compost by volume. These percentages are slightly different from the CW4CB study (60% sand and 40% compost), but still within the requirements of the MRP Provision C.3 and BASMAA standard. A precise match could not be accommodated due to the project schedule and approaching stormwater sampling opportunities.

2.3 BIOCHAR SELECTION

Primary biochar selection factors included availability in the Western United States, to ensure any biochar tested would likely be available for use in the San Francisco Bay Area, and acceptable hydraulic conductivity. Initially, the goal of hydraulic testing was to identify biochar-BSM blends that had a hydraulic conductivity in an acceptable range of 5 to 12 in/hr (Appendix C). However, destruction of biochar during the Modified Proctor compaction procedure required adjustments in procedures that made the 5 to 12 in/hr an inappropriate comparison. Instead, biochar-BSM blends that provided the most consistent hydraulic conductivity relative to the standard BSM were selected for testing. Secondary biochar selection factors included a range of pyrolysis temperatures and costs. Up to five biochars could be tested under limitations of timing, resources, and desired minimum samples per column (Appendix A).

2.4 HYDRAULIC TESTING

The BASMAA specification for alternatives to BSM requires testing of saturated hydraulic conductivity (k_{sat}) at a compaction of 85% maximum dry density (MDD) using the Modified Proctor method (BASMAA 2016). Because of the observation that the standard level of compaction was crushing the biochar particles, and thus changing their characteristics, it was decided to compact to 85% MDD using the Standard Proctor method, which uses reduced energy. Before hydraulic testing, a compaction curve was developed by the Standard Proctor method to determine MDD for each biochar-amended BSM.

⁴ One column was not analyzed due to a sample that is presumed lost after being shipped to the water chemistry laboratory.

Hydraulic testing was used as a screening tool to select the five media for the columns from the nine media tested. This testing, using deionized water that was de-gassed under vacuum and agitation overnight, was performed according to ASTM D2434 Standard Test Method for Permeability of Granular Soils (Constant Head) using a six-inch-diameter permeameter. All test equipment was purchased from the Humboldt Manufacturing Company.

2.5 COLUMN SETUP AND SEASONING RUNS

Six columns were constructed for this study, each column consisting of a 36-inch-long glass pipe with an internal diameter of 7.5 inches (Figure 2). Each column was capped with a Teflon plate that was milled to create a circular channel to nest the pipe in and make a water tight seal. Seven drainage holes were milled through each plate. To create flow paths for draining water to each of the seven drainage holes, each plate had additional drainage veins milled in the top side of each plate. To match each biochar-amended BSM column flow rate to the control BSM flow rate (i.e., outlet control), stainless steel screws were used to block the drainage holes (Figure 3). To create a water tight seal between Teflon cap and glass pipe without an adhesive or caulking (which could adsorb PCBs), ratcheting straps were used to apply force to the top of the glass columns to keep them firmly seated in their Teflon caps. Plugging the drainage holes and filling the empty column with water proved the seal was sufficient. Stainless steel mesh screen (number 40, opening size nominally 0.42 mm) was cut to shape and placed on top of the Teflon cap to keep media from filling the drainage channels and exiting the column. A two-inch layer of sand was placed on top of the stainless steel screen, followed by 18 inches of either the standard BSM control media or one of the five biochar-amended BSM.



Figure 2. Column test setup at Sacramento State showing five of six columns

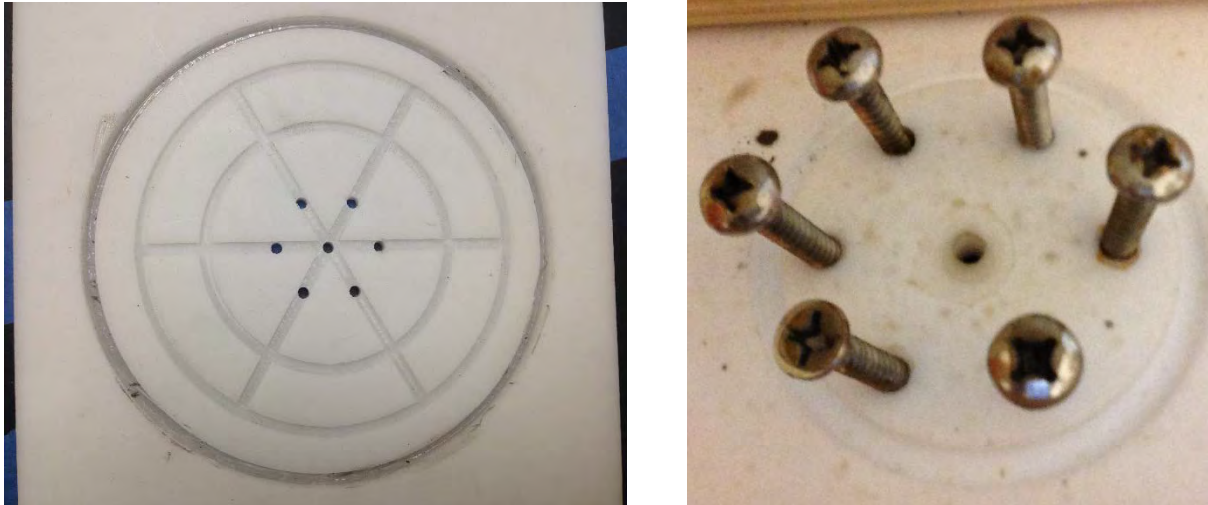

Figure 3. Teflon Column Cap with Drainage Veins and Holes (left) and Stainless Steel Throttling Screws (right)

Initial attempts at media placement and top-down hydro-compaction failed to achieve adequate infiltration rates so a wet placement technique was used to introduce water from the bottom of the column via a water supply cap fitted to the invert column cap. While placing the media in 1- to 2-inch lifts, water was slowly introduced and allowed to flow up through the media. As the previous lift was saturated and water reached the surface, an additional lift of media was placed. This technique allowed the air in the pore space of the media to be pushed out of a relatively thin overlying layer of media. Once all 18 inches of media were placed, the water was allowed to continue rising above the surface of the media until six inches of ponded water was achieved. Once this occurred, the water supply cap at the bottom of the column was removed and the water was allowed to drain. This draining of the six inches of ponded water served to hydraulically compact the media. An additional volume of water—equivalent to a depth of 18 inches of water—was added slowly to the top of the column to maintain the six inches of ponded water until the column was fully drained.

After the columns were filled with media and hydraulically compacted, the media was tested again to verify that infiltration rates were similar to field conditions. Columns were saturated and a falling head test was performed. The standard BSM had the slowest drain time and many of the biochar-amended columns had much faster drain times. Once the drain times had stabilized, a minimum level of outlet control was used on five columns so that the drain time in each column was more consistent with the slowest draining column.

During the first sampling run it was observed that all column effluents had high turbidity. To further stabilize the columns, two “seasoning” runs were performed. Turbidity was the only water quality measurement taken during these seasoning runs. Each run applied 18 inches of stormwater to the column. These seasoning runs were successful in decreasing turbidity in the effluent. Because stormwater was used, additional pollutant loading to the columns occurred during these two runs.

2.6 STORMWATER COLLECTION

Stormwater used during the seasoning and sampling runs was collected during storm events at two sites within the area covered by the MRP that were identified in previous studies as having consistently elevated concentrations of PCBs in the runoff (BASMAA 2017). Both sites were tree well locations that

were installed in Oakland, CA, and tested during the CW4CB project. In addition to being previously monitored, tree well 2 (Ettie St and 28th NW) and tree well 6 (Poplar and 26th SW) were considered safe locations to conduct stormwater monitoring. To collect the necessary volume of stormwater for the study, OWP staff accompanied KLI staff to each site during two storm events and pumped stormwater directly from the street gutter into clean five-gallon glass carboys. These were then transported back to OWP in Sacramento, CA, by OWP staff and stored at room temperature until use. Stormwater had to be collected before the columns were ready for experimental runs. Complications in acquiring suitable BSM, hydraulic testing, and preparing columns delayed the experiment for three months, far enough into the wet season that the likelihood of ample rain events was quickly diminishing. To hedge against a lack of late-season rain events, sufficient stormwater was collected from two storm events to perform all sampling runs and seasoning runs. The weather was tracked in hopes of sampling a third storm event, but additional storm events failed to materialize. Nine carboys were filled from each sampling location during each monitored storm event. The preference was to use the stormwater within 72 hours of collection, but additional time was needed to finish the construction and initial seasoning of the columns. The stormwater was stored for four days before the first run. The stormwater for the dilution run was used two weeks after collection. The stormwater for a replacement run (required as a result of bottle breakage during shipping) was used four weeks after collection. This was not a concern for PCB analysis because of the stability of PCBs, though particle agglomeration likely occurred causing associated pollutants to be more easily removed. This was counteracted by using high-shear mixing as described below.

2.7 SAMPLING RUNS

Following the purpose to screen as many biochars as possible for further study (see Appendix A), only three sampling runs were performed for all six columns using undiluted stormwater. A fourth run was conducted on one biochar-amended BSM column (CO4; BioChar Solutions) and the standard BSM control column⁵ (CO6; Control) using stormwater diluted at a one-to-nine ratio. A single replacement run was performed for the first undiluted run for one column (CO1; Sunriver) due to loss of a sample bottle that was damaged in transit between laboratories. A unique influent had to be generated for this replacement run. Each run applied 18 inches of water to each column to simulate the hydraulic loading from storm events near typical water quality design storms. For example, if bioretention is sized to 4 percent of a drainage area that has a volumetric runoff coefficient of 0.8, a 0.9-inch storm size would generate 18 inches of hydraulic loading to the bioretention surface.

A variety of influent concentrations was desired, however, all runs were performed within a period of 30 days so water quality analysis from the first run was not known when performing later runs. Consequently, the selection of which stormwater source (sampling location) and which storm event to use for each run was based on past data from the sampling locations (Table 3). Additionally, each run was sequentially dosed directly from a subset of carboys from each storm. Because all carboys were not used in a run, the visual quality of the stormwater in each carboy was used to select carboys with the most sediment for each run. The dosing sequence is described below.

At the start of each sample run, six cleaned and empty carboys were labeled for effluent collection for all columns and one clean and empty carboy was labeled for influent doses. All sample bottles were labeled to associate them with the collection carboys. Stormwater in the five-gallon storage carboys

⁵ As previously explained, this sample was not analyzed.

were vigorously agitated before each dose with a stainless steel paddle mixer until all sediment was suspended. A glass beaker marked for the level of a single dose was filled from the carboy and used to dose each column in turn. The dose was sized to be equivalent to one inch of water depth inside the 7.5-inch-diameter column. Each column and the carboy collecting influent received 18 total doses. If the stormwater storage carboy did not have sufficient volume for a complete round of dosing (six column doses and one influent dose), additional water was added to the carboy from the next carboy selected for dosing. This assured that the same batch of stormwater was used for a single dose to each column and influent carboy. Dosing the influent carboy for each round of column dosing allowed a single influent sample from the influent carboy at the end of all 18 doses to represent the composite influent of all columns for that run. If at any time during dosing a column had more than six inches of ponded water the dosing would stop until the water drained to a height of three inches. Figure 4 presents the column test setup.

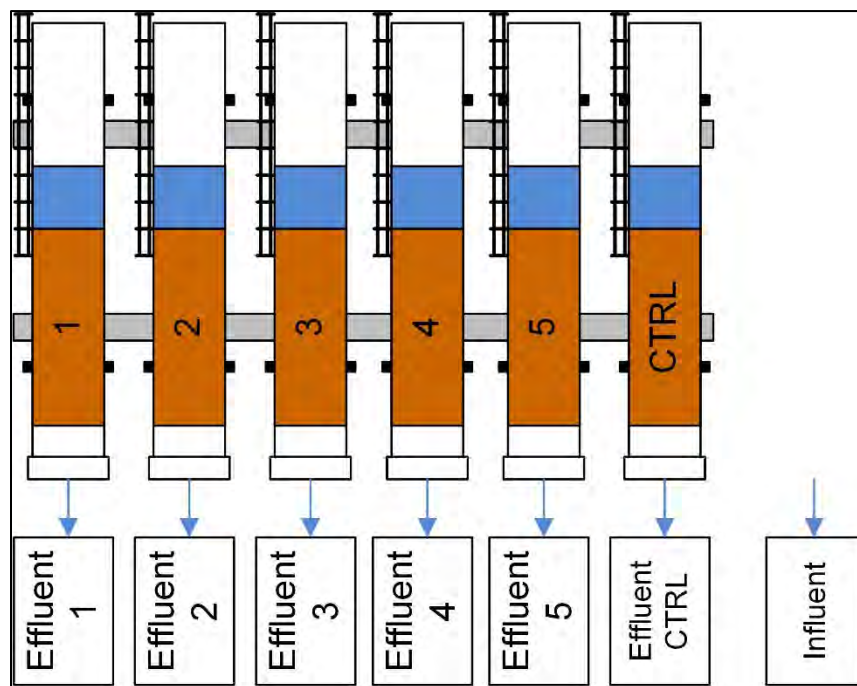

Figure 4. Column Test Setup

Column test observation forms were kept for each column and the time at which each dose was applied and the height of ponded water in the column was recorded. By recording the height of the water in the column at regular time intervals, it was possible to calculate an infiltration rate at each time step over the course of the sampling run. Three times during the dosing of the columns a grab sample was taken from the effluent of each column and tested using on-site meters to measure pH, temperature, and turbidity. At the midpoint of each sampling run, as specified in the sampling protocol to achieve ultra-low detection limits, mercury samples were collected directly from the effluent stream of the column into a preserved sample bottle. Direct collection eliminated losses that would occur if collecting from the effluent carboy. One person was able to handle bottle filling without the aid of a second pair of hands because the sampling person did not have to touch anything while handling the bottle because flow was collected at the air gap as water fell between the column and the effluent carboy.

After all influent water was applied, the columns were allowed to drain until no water was visible in the pore spaces of the soil and the effluent discharge had slowed to a drip. Once the columns drained, the carboy that received influent doses and the effluent carboys of each column were agitated with their own stainless steel paddle mixer before filling all required sample bottles. Sample bottles were refrigerated for up to two days then packed in blue ice and shipped overnight via FedEx to ALS for analysis.

Additional details are presented in Appendix B.

2.8 CONSTITUENTS AND LABORATORY METHODS

As specified in the study design (Appendix A) and Sampling and Analysis Plan (Appendix B), total PCBs⁶ and total mercury were analyzed for all samples. Constituents for analysis of water samples must be consistent with Table 8.3 of the MRP. Table 1 lists the constituents and test methods for this study.

In addition to PCBs and total mercury, the other constituents selected for influent and effluent analysis were suspended solids concentration (SSC), turbidity, and total organic carbon (TOC). Suspended solids concentration was selected for measurement rather than total suspended solids (TSS) because the method more accurately characterizes larger-sized fractions within the sample by avoiding subsampling, while turbidity was selected because it is an inexpensive and quick test to describe treatment efficiency where a strong correlation to other pollutants has been established. As with the SSC analysis, TOC was included because it is a MRP Provision C.8.f POC monitoring parameter and is useful in cases where methylation is a concern.

Table 1. Selected Aqueous Constituents for Media Testing in Laboratory Columns

Constituent	Test Method	Reporting Limit
SSC	ASTM D3977-97	1 mg/L
Turbidity	Field meter	1 NTU
TOC	EPA 9060	2 mg/L
Total Mercury	EPA 1631E	0.5 ng/L
Total PCBs (Sum of RMP 40 congeners) in Water	EPA 1668C	190-220 pg/L

2.9 ANALYSIS AND STATISTICAL TESTING

Effluent and influent concentrations are presented independently and in chronological order to observe potential trends with loading. Additional analysis was performed for PCBs. Effluent concentration is also presented normalized by influent concentration for comparison to CW4CB study results. Normalization allows comparisons where influent concentrations vary between studies and where effluent concentration is dependent on influent concentration. In addition to traditional graphical or tabular comparisons, statistical testing was performed for PCBs using the Mann-Whitney U test (a rank sum test) on columns showing the greatest differentiation of performance. Correlations between PCB and SSC, and total mercury and TOC were also examined. Comparing total PCBs to suspended solids indicates whether suspended solids have a consistent quantity of associated PCBs.

⁶ The 40 individual congeners routinely quantified by the Regional Monitoring Program (RMP) for Water Quality in San Francisco Bay include: PCBs 8, 18, 28, 31, 33, 44, 49, 52, 56, 60, 66, 70, 74, 87, 95, 97, 99, 101, 105, 110, 118, 128, 132, 138, 141, 149, 151, 153, 156, 158, 170, 174, 177, 180, 183, 187, 194, 195, 201, and 203. The sum of these congeners are referred to as the PCBs or RMP 40 throughout this report.

3 RESULTS

3.1 BIOCHAR CHARACTERISTICS, HYDRAULIC CONDUCTIVITY, AND SELECTION

The study design called for water quality column testing of five biochars. Nine biochars produced in the Western United States were identified as potential candidates (Table 2). Hydraulic tests of the nine biochar-BSM blends produced a wide range of results. More details of the hydraulic conductivity calculations and particle size distributions are presented in Appendices D and E, respectively. Pulverization⁷ of biochar during the compaction process could be a contributing factor to the range of the observed results, even when using the lower-energy Standard Proctor method. The five biochar-BSM blends that provided the most consistent hydraulic conductivity compared to the standard BSM were selected for further testing. The selected biochar are highlighted in Table 2, and include Sunriver, Rogue, Phoenix, BioChar Solutions (also used in CW4CB), and Agrosorb. Their associated conductivity measurements were within 4 in/hr of the standard BSM, except for Agrosorb, which was 4.3 in/hr above the value for standard BSM. The selected biochar cover a range of pyrolysis temperatures and costs, but all were manufactured at 500 °C or above. Contrary to expectations, cost did not correlate with pyrolysis temperature.

Table 2. Characteristics for Biochar Considered for Water Quality Testing

Biochar ^a	Ksat ^b (in/hr)	Texture ^c	Cost (\$/yd ³)	Pyrolysis Temp (°C)	Supplier Location
Blacksorb	2.56	Variable size, 3mm to fines	250	900	CA
Sonoma	5.11	Variable size, 1 cm chips to sand size particles, lots of fines	240	1315	CA
Pacific	5.41	Variable size, 1 cm chips to sand size particles, some fines	90	700	CA
Sunriver	7.67	Variable size, mostly pine needles with some small twigs and chips, 2 cm, little fines	500	500	OR
Rogue	7.85	Uniform size, 4mm, little to no fines	250	700	OR
Phoenix	10.4	chips, 1-5 cm, little to no fines	254	700	CA
Control – Standard BSM from Voss	10.8	Organics and sand	40	N/A	CA
Biochar Solutions Large	11.0	Chips, 2.5 cm, lots of fines	225	700	CO
Agrosorb	15.1	Large chips, 2 cm, lots of fines	250	900	CA
Biochar Now Medium	17.2	Uniform size, 3mm to 26 mesh, little to no fines	350	600	CO

a. Biochars are sorted by Ksat and the five biochars closest to BSM were selected for column tests (shaded).

b. Ksat values are at 85% maximum dry density using standard Proctor. Computations are presented in Appendix D.

c. Particle Size Distribution of each biochar is presented in Appendix E.

⁷ Hydraulic compaction was used in the water quality testing columns to avoid pulverization.

3.2 QUALITY ASSURANCE AND QUALITY CONTROL

Data quality assurance (QA) and quality control (QC) was performed in accordance with the project's SAP/QAPP (Appendix B). The SAP/QAPP established data quality objectives (DQOs) to ensure that data collected are sufficient and of adequate quality for their intended use. These DQOs include both quantitative and qualitative assessments of the acceptability of data. The qualitative goals include representativeness and comparability, and the quantitative goals include completeness, sensitivity (detection and quantization limits), precision, accuracy, and contamination. Measurement quality objectives (MQOs) are the acceptance thresholds or goals for the data. The quality assurance summary is presented for PCBs followed by total mercury, TOC, and SSC.

3.2.1 PCBs

The column water dataset included 26 field samples (including 1 field replicate), with 3 blanks, 5 laboratory control samples (LCSs), and one matrix spike/matrix spike duplicate (MS/MSD) pair reported for the RMP 40 PCB analytes (with their coeluters, yielding 38 unique analytes). This met the minimum number of QC samples required. All samples were analyzed within 30 days, less than the recommended hold time of 1 year. Three of the analytes had poor recovery (>70% deviation from target values in MS samples) and were rejected as were 2 analytes that had individual field sample results <3x higher than blanks. Overall 91% of the field sample results were reportable. Two PCBs were non-detect (ND) in 100% of the samples, but all the rest had detects in more than half the samples. However, a large percentage of results were below the lab's reporting limit, and 17 analytes had relative percent differences (RPDs) in the field replicates below 100%, and thus 62% of all results were flagged as estimated. Additionally 25 of the 38 unique analytes had recoveries between 35–70% above target values, so they were flagged as qualified. Nearly half of the data is flagged as estimated (i.e., below the reporting limit (RL) but above the method detection limit (MDL)) or qualified (not compliant with project SAP/QAPP), and approximately 5% of the data were rejected for the reasons mentioned above. Thus individual results are not quantitative at the target levels of confidence (+/- 30%) and thus the data should not be used to draw conclusions regarding attainment of set performance or water quality thresholds. However, the primary management question in this study is answered using the relative comparison of results within this study. Consequently, the data quality is satisfactory for the purpose of this study and all data were used.

3.2.2 Total Mercury (Hg), TOC, and SSC

All field sample results in the Hg/TOC/SSC dataset for water were reportable. The column water dataset included 25 field samples for Hg and SSC, and 1 field replicate for SSC, with 23 samples reported for TOC. All TOC results were analyzed at least in duplicate (some 3 or 4 times). Blanks were reported for all analytes, MS/MSDs for Hg and TOC, and LCSs for SSC and TOC, meeting the minimum number of QC samples required (1 per 20 or per batch of blank, precision, and recovery sample types). Samples were all analyzed within their respective hold times (28 days for Hg and TOC, 7 days for SSC). No results were non-detect, although a few Hg and TOC were DNQ (detected not quantified). Mercury was detected in blanks averaging 2-3x MDL in the two batches, but field sample results were all over 3x higher than blanks, so all results were flagged for blank contamination, but no results were censored. Precision was acceptable, averaging <10% RPD for SSC, <5% for TOC, and <20% for Hg, so no precision qualifiers were added. Similarly, average recovery deviated <10% from target values for all analytes, so no recovery flags were added. Overall, data quality is satisfactory for the purpose of this study and all data were used.

3.3 COLUMN TEST RUNS

Five sampling runs were performed and influent concentrations and stormwater collection characteristics for each run are presented in Table 3. Not all stormwater collected at one location during one storm was used in a single run, so extra water was available for later runs as described in Table 3. In each run, the storage carboys with more sediment (visual judgement) were preferred in early runs. Consequently, water remaining for later runs had less sediment. Infiltration rates and influent and effluent concentrations grouped by column and run are presented in Table 4. Graphical comparisons and discussion is presented in the following sections.

Table 3. Influent Descriptions, PCB and Mercury Concentrations, and Columns Dosed for each Sampling Run

Influent ID	Run Type	Storm ID: No. - Location ^a - Collection Date	Column Run Date	Influent Concentrations				Columns Loaded
				PCB (pg/L)	Total Hg (ng/L)	TOC (mg/L)	SSC (mg/L)	
Influent 1	no dilution	Storm 2 - TW2 - 4/6/18	4/10/2018	19600	9.99	5.39	19.4	all
Influent 2	no dilution	Storm 1 - TW2 - 3/1/18	4/13/2018	18600	10.2	1.71	40.2	all
Influent 3	no dilution	Storm 2 - TW6 - 4/6/18	4/17/2018	9860	9.86	1.64	16.3	all
Influent 4	9X dilution	Storm 1 - TW2 - 3/1/18 ^b	4/19/2018	2100	3	NA	1.9	CO4, CO6
Influent 5	no dilution	Mix of Storm 1 and 2 - TW2 - 3/1/18 and 4/6/18 ^c	5/9/2018	8160	NA	NA	NA	CO1

a. Stormwater collection locations were at two sites in West Oakland: TW2 is the influent to the Tree Well Site 2 (TW2) on Poplar at 26th and TW6 is the influent to Tree Well Site 6 (TW6) on Ettie St. near 28th

b. TW2 selected because CW4CB indicated it had lower concentrations and was selected to avoid dilution of a high-concentration sample (in this study TW2 had higher concentrations but those results were not available at the time)

c. The dirtiest (visually) of the remaining storage carboys from storms 1 and 2 that were not used in previous runs were selected to get a concentration near what was dosed in Run 1 because this was a makeup for Run 1.

Table 4. Infiltration Rates and PCB, Mercury, TOC, and SSC Results for each Sampling Run

Column ID	Biochar	Test Runs	Inf. Rate (in/hr)	PCBs		Total Mercury		TOC		SSC	
				Influent (pg/L)	Effluent (pg/L)	Influent (ng/L)	Effluent (ng/L)	Influent (mg/L)	Effluent (mg/L)	Influent (mg/L)	Effluent (mg/L)
CO6	Control (BSM only)	Run 1	6.7	19600	2920	9.99	14	5.39	32.9	19.4	118
		Run 2	6.0	18600	4680	10.2	13.1	1.71	15.9	40.2	35
		Run 3	3.7	9860	960	9.86	11.3	1.64	17.2	16.3	26.7
		Run 4	N/A	2100	NA ^a	3	7.41	NA	10.9	1.9	11.1
CO1	Sunriver	Run 1	>20	19600	NA ^a	9.99	24.4 ^b	5.39	26.7 ^b	19.4	116 ^b
		Run 2	>12	18600	32000 ^b	10.2	9.68 ^b	1.71	12.3 ^b	40.2	21.9 ^b
		Run 3	5.7	9860	383	9.86	9.74	1.64	12.1	16.3	12.5
		Run 5	N/A	8160	662	NA	NA ^c	NA	NA	NA	NA
CO2	Rogue	Run 1	>20	19600	19400 ^b	9.99	16.3 ^b	5.39	11 ^b	19.4	104 ^b
		Run 2	3.2	18600	926	10.2	8.58	1.71	5.72	40.2	13.3
		Run 3	5	9860	4510	9.86	2.17	1.64	5.12	16.3	8.4
CO3	Phoenix	Run 1	8	19600	2000	9.99	6.77	5.39	42	19.4	50.3
		Run 2	7.3	18600	2270	10.2	5.69	1.71	19.1	40.2	14.5
		Run 3	3.8	9860	411	9.86	6.02	1.64	21.6	16.3	19.3
CO4	BioChar Solutions	Run 1	8.5	19600	3270	9.99	15.2	5.39	28.9	19.4	89.1
		Run 2	>12	18600	2310	10.2	11.2	1.71	13.8	40.2	17
		Run 3	3.7	9860	839	9.86	7.58	1.64	14.4	16.3	16.5
		Run 4	5.5	2100	782	3	5.26	NA	NA	1.9	9.7
CO5	Agrosorb	Run 1	8.4	19600	2160	9.99	7.57	5.39	27.7	19.4	78
		Run 2	4.9	18600	2920	10.2	4.53	1.71	12.5	40.2	17.3
		Run 3	5.2	9860	586	9.86	7.36	1.64	12	16.3	11.7

a. Lost sample

b. Values are not used in further analysis due to unusually high initial infiltration rates

c. No Hg for Run 5 because three samples were successfully analyzed and only PCB required a replacement run.

3.3.1 PCBs

Both qualified and estimated influent and effluent PCBs concentrations are presented chronologically in Figure 5. The first two runs had similar influent concentrations and effluent quality was generally similar, despite sediment and turbidity increases in the first run. Effluent concentrations were generally lower for the third run, but influent concentration for the third run was nearly half that of the previous runs. The fourth run is the dilution run for only two columns. The fifth run is the replacement run for the first Sunriver run, which could not be analyzed for PCBs due to a broken sample bottle. All columns reduced concentrations of PCBs. This is expected because PCBs are largely bound to particles and media filters work well to remove these particles. Biochar-amended BSM seems to have improved treatment when compared to the control BSM (CO6), but a more explicit comparison is presented later in this report.

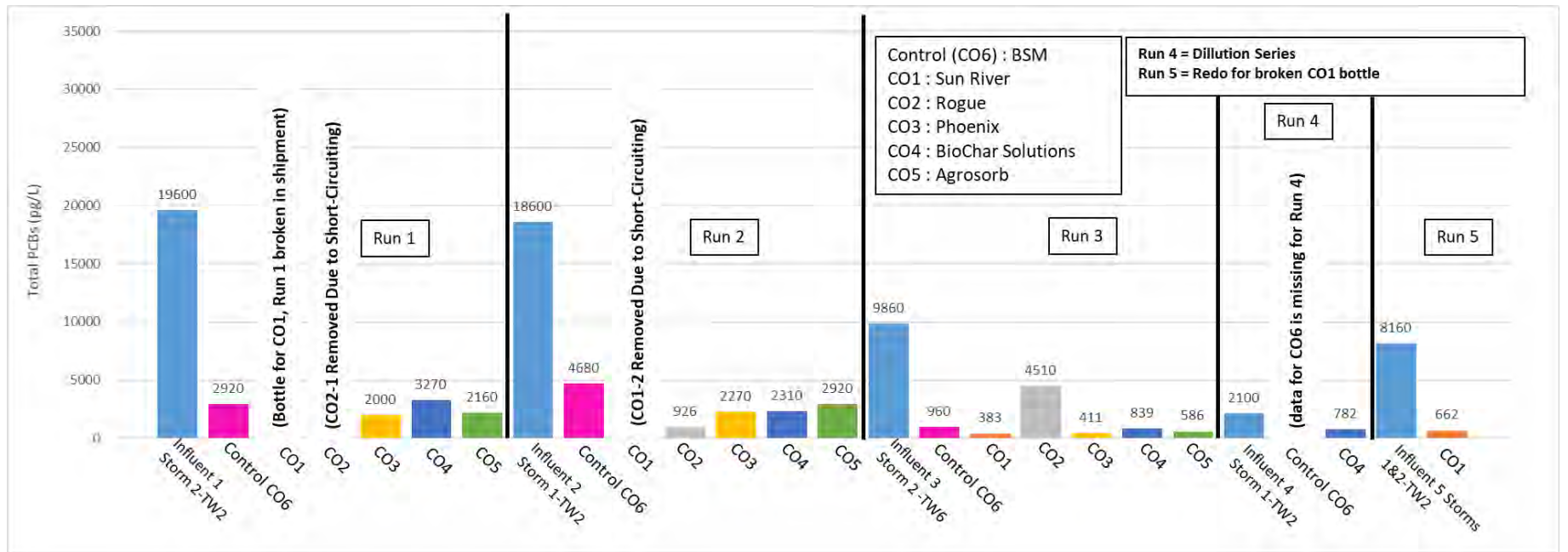

Figure 5. Total PCB Concentrations over Time

The data from Sunriver biochar-amended BSM (CO1) for test runs one and two, and the Rogue biochar-amended BSM (CO2) for test run one have been censored because both of these columns experienced unusually high initial infiltration rates that is indicative of short-circuiting of the media. The infiltration rates were so high that water did not remain in the column at the beginning of a subsequent dose when water level and time would be recorded. To drain this fast, the Sunriver column would have had an infiltration rate above 12 inches per hour and the Rogue column above 20 inches per hour. Because the occurrence of high infiltration rates are not successively repeated for later runs or in the initial runs of other columns, these two measurements have been deemed not representative of a properly compacted media and are not included in further analysis in this report. All other runs had had initial infiltration rates of 3 to 9 in/hr. Run 2 for BioChar Solutions (CO4) exceeded 12 in/hr, but that data was used because the first run was in an acceptable range, signifying that the variation in hydraulic performance could not be attributed to a lack of media seasoning or insufficient compaction. Consequently, later hydraulic variability could be an important longer-term characteristic of the media that would be important to consider in the study.

Despite initial seasoning that fully saturated the media, small air pockets were observed in some columns and it is probable that none of the columns were fully saturated during runs, so infiltration values are not representative of saturated hydraulic conductivity. Air pockets were not fully removed during the sampling runs because, unlike the initial seasoning and hydraulic compaction, water was introduced from the top of the columns.

Figure 6 displays the influent and effluent concentrations for PCBs grouped by column, along with means. There are four influent values because run 5 for Sunriver (CO1) required a unique influent (8,160 pg/L) which replaced the run 1 influent value (19,600 pg/L). Mean effluent concentrations for all biochar-amended BSM are lower than the mean effluent concentration of the control BSM (CO6), with the Rogue biochar-amended BSM (CO2) average just under the control BSM average.

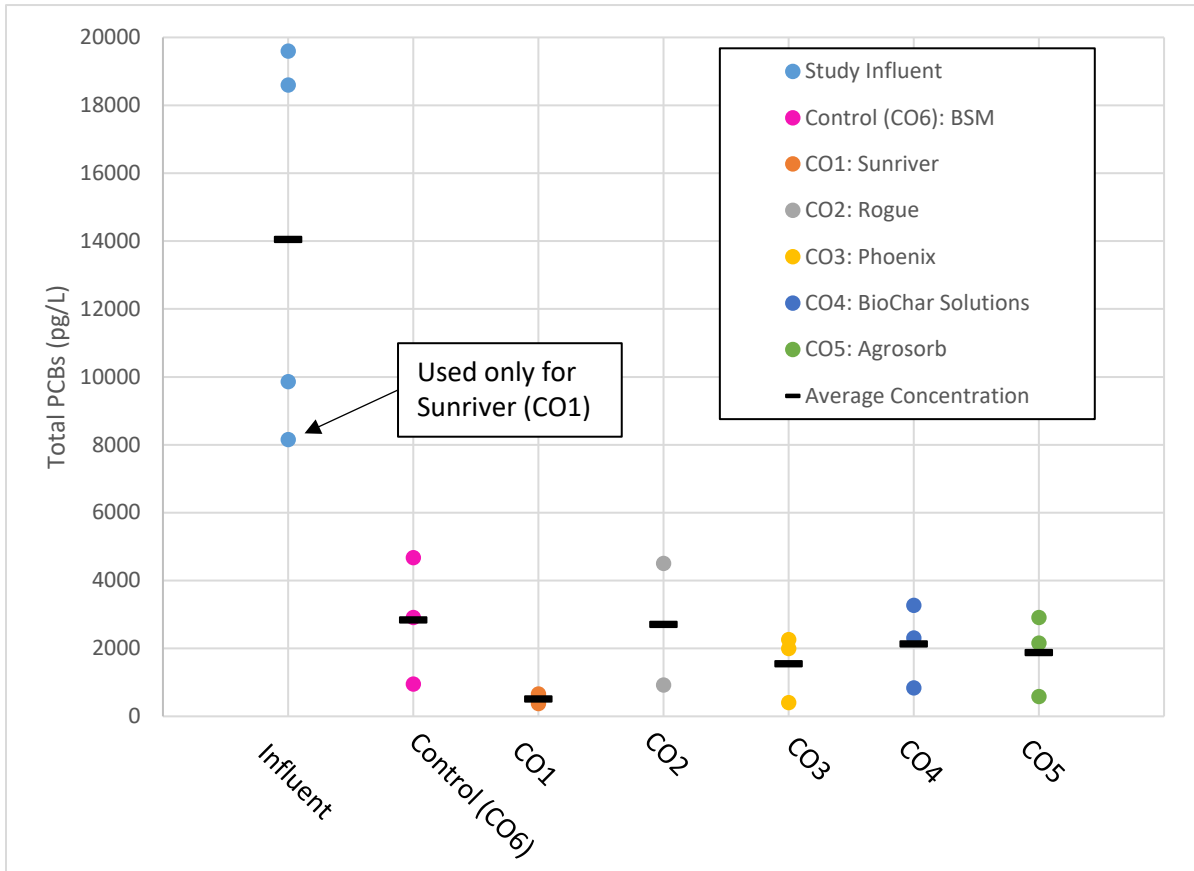

Figure 6. Observed Total PCB Concentrations for Undiluted Influent Runs and Column Test Media Effluent

Dividing each column effluent concentration by the paired influent concentration (C_e/C_i) normalizes the data to the influent and aids in comparison. In Figure 7, a red line has been placed at the mean value for the control BSM data. The noticeable difference between the C_e/C_i graph and the concentrations graph is that Rogue biochar-amended BSM (CO2) now has a higher mean than that of the control, while the average means for all other biochar-amended BSM are below the control. This is because each column had similar effluent values (4,680 and 4,510 pg/L, for the control and Rogue, respectively), but the influent concentration was substantially different (18,600 and 9,860 pg/L). This analysis indicates that all biochar may outperform the standard BSM mix with the possible exception of Rogue, but the data are limited. Further, the duplicate sample of run 3 for Rogue indicates it has better performance than the control but more data would be needed to show the primary sample was an outlier. The dilution run is not included in the analysis presented in Figure 6 because the lower influent concentration was not applied across all columns.

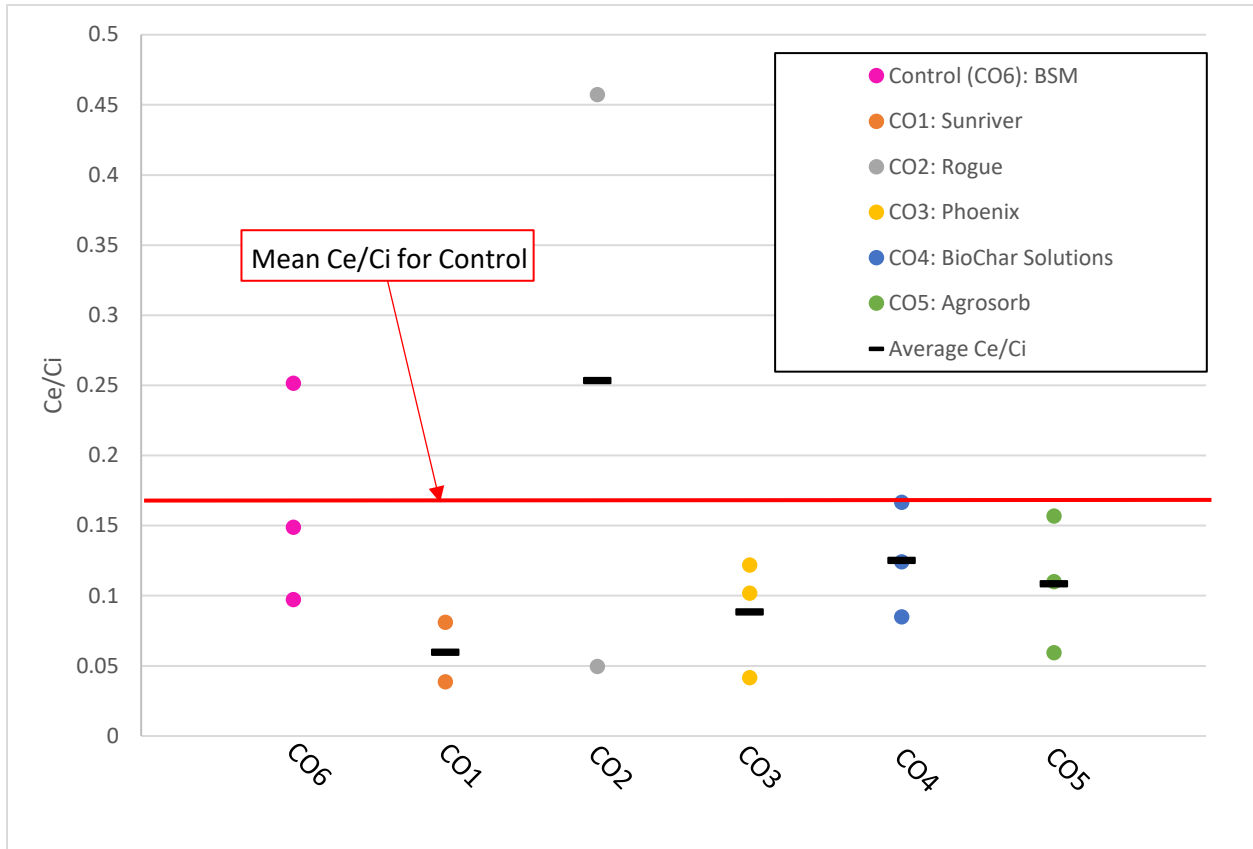

Figure 7. Ce/Ci Total PCB Concentrations for Column Test Media

Figure 8 compares the concentrations from this study to those from the CW4CB pilot site that tested BSM next to BSM with biochar. For ease of comparison, the influent concentrations from both field site influents are combined into one dataset under the label CW4CB Combined Influent. All five of the biochar-amended BSM columns are combined into one dataset under the label Study Biochar.

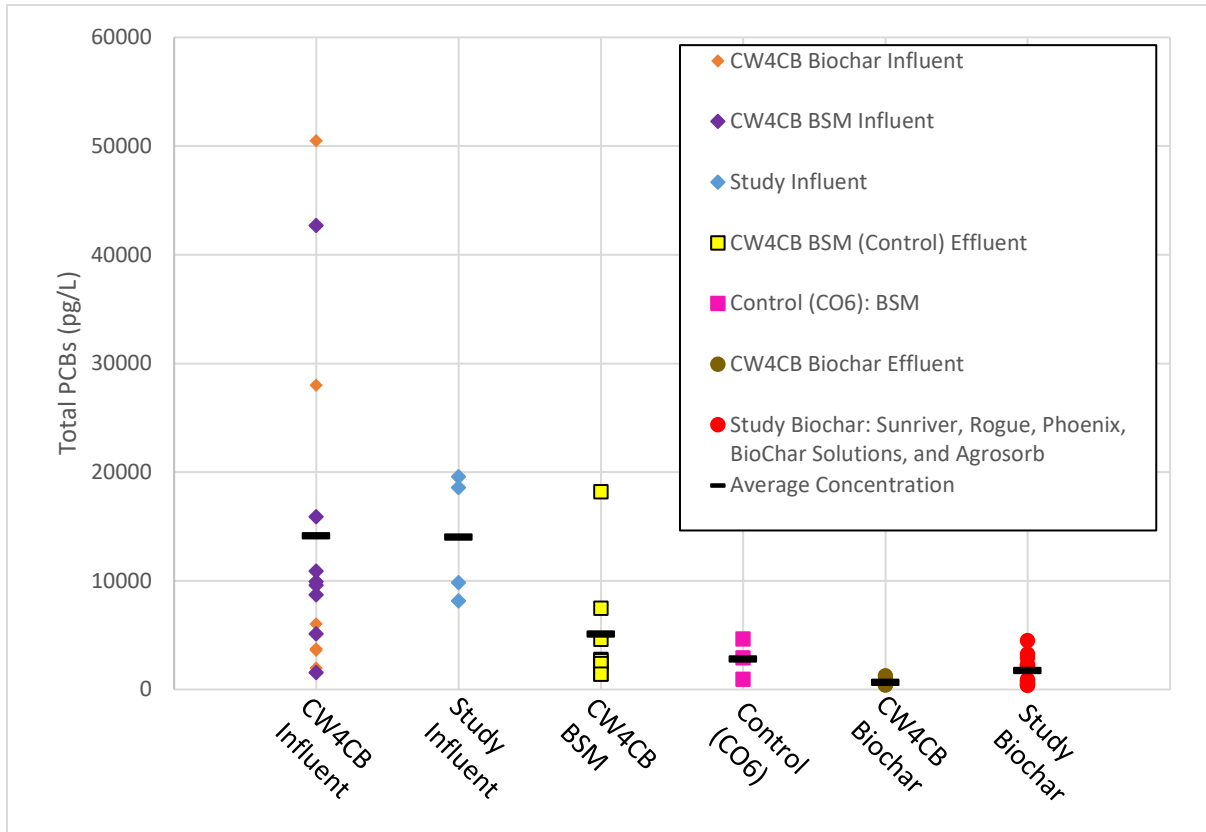

Figure 8. Total PCB Concentrations for CW4CB Pilot Sites Influent, Undiluted Influent Runs, CW4CB BSM Effluent, and Column Test BSM Effluent, CW4CB Biochar-amended Effluent, and Column Test Biochar-amended Effluent

The PCB concentrations in stormwater used in this study were within the range of PCB concentrations in influent at the CW4CB location that compared BSM and biochar-amended BSM. The range of influent concentrations for this study (9,860 pg/L to 19,600 pg/L) was narrower than the ranges of influent concentrations for both the CW4CB BSM site (1,560 pg/L to 42,700 pg/L) and the CW4CB biochar-amended site (1,990 pg/L to 50,500 pg/L). The range of influent concentrations from this study overlapped the middle range of the CW4CB grouped influent concentrations with the influent mean concentration from this study lower by 116 pg/L (less than 1% difference). The Control BSM effluent concentrations of this study were nearly half the concentrations of the CW4CB study BSM effluent concentrations. However, the biochar-amended BSM effluent concentrations from this study were higher than the biochar-amended CW4CB study. As before, normalized effluent is examined for the case that effluent has some dependence on influent.

Figure 9 compares effluent concentrations normalized by their paired influent concentrations for the CW4CB BSM, study BSM, the CW4CB biochar, and all study biochars combined.

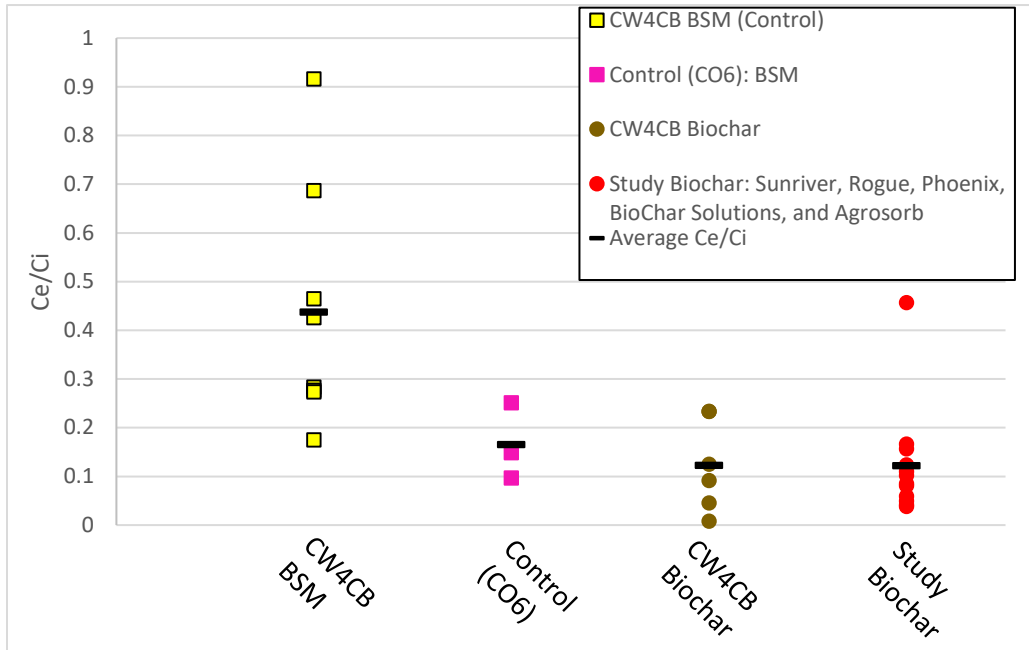

Figure 9. Ce/Ci Total PCB Concentrations for CW4CB Pilot Sites and All Biochar Test Media

Results from both CW4CB and this study indicate that PCB removal by biochar-amended BSM is less sensitive to influent concentrations than standard BSM. The influent-normalized performance (Ce/Ci) for the standard BSM (control) in this study appeared slightly improved compared to the CW4CB control BSM pilot site. In contrast, BioChar Solutions (CO4) influent-normalized performance (Ce/Ci) in this study was similar to the CW4CB biochar-amended pilot site (also using BioChar Solutions).

The improved performance suggests that conditions in the column tests were more ideal, or at least not worse, than field conditions. The normalized biochar data showed better agreement, but a secondary control to the field condition was planned to allow a more direct comparison between the same biochar. This was accomplished by using the same biochar (BioChar Solutions, CO4) as was used at the CW4CB site. The CW4CB biochar site and the column constructed with the same biochar (CO4) are compared in Figure 10, including the dilution run. Though data are limited, it appears that the CW4CB performance is slightly superior, which is in contrast to the comparison of standard BSM. This suggests that there are performance factors influencing the CW4CB site that were not replicated in this study, and there may be differences, besides biochar, contributing to the improvement of performance of the CW4CB biochar over the standard BSM. The CW4CB biochar site also tested a wider range of influent concentrations (Figure 8), which may be another cause for differing results.

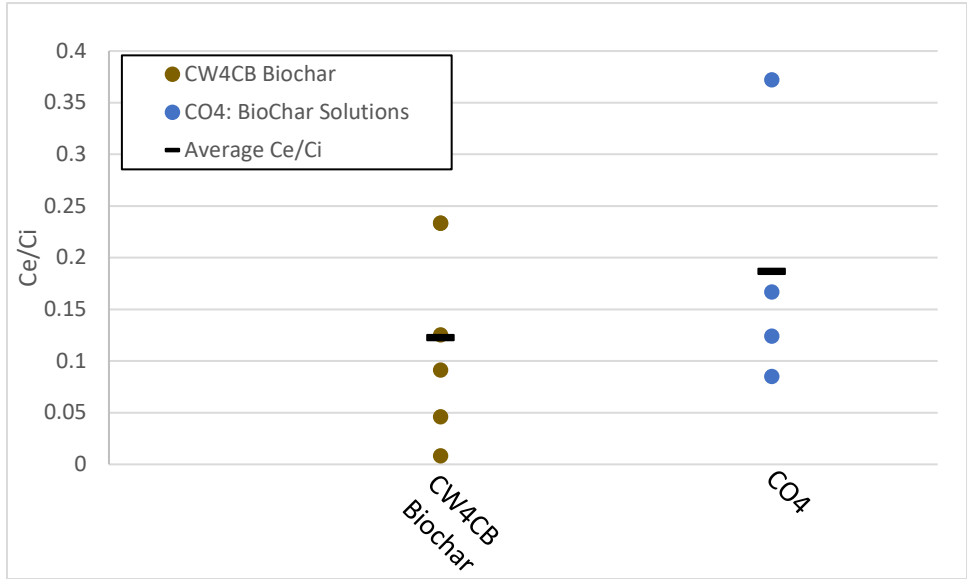

Figure 10. Ce/Ci Total PCB Concentrations for CW4CB Biochar Pilot Site and BioChar Solutions Test Media

All effluent concentrations are plotted against influent concentrations in Figure 11, and all media show removal of PCBs as evidenced by all points appearing under the 1:1 line representing no treatment. The effluent data appears stacked due to the common influent for three of the five runs. Overall, the data may be indicating an irreducible concentration somewhere around 300 pg/L (select Run 3 effluent concentrations) to 800 pg/L (Run 4 dilution effluent concentration), but only a single data point represents the lower end of the influent range.

The dilution run gives a rough estimation of whether biochar-amended BSM would be effective in treatment of concentrations that are lower than the sampled watershed. The single run was performed with stormwater diluted at a one-to-nine ratio to assess one biochar-amended BSM (BioChar Solutions) and the control BSM (The control BSM analysis is not available). The biochar-amended BSM continued to show reduction potential, but the removal relative to influent was not as great, indicating that the influent value may be approaching an irreducible concentration. Even though this analysis is on the most limited basis, the data indicate that biochar may also show benefits at lower concentrations. However, the variation in water column concentration is much larger than that tested in this study. The range of the total PCBs concentration of influent samples was compared to the range found in a summary of water column PCBs concentration data in the Bay Area (McKee et al. 2015). Of 31 locations sampled over several years, seven had concentrations lower than the range of the media study, 16 were within the range, and eight were above. Most of these monitoring locations were in-channel rather than higher upstream in the drainage system where BSM is more traditionally used. Consequently, actual concentrations at upstream BSM locations could vary even more since discrete PCB source areas should get diluted as other cleaner water and sediment combine downstream. Gilbreath et al. (2018) reported a maximum of 160,000 pg/L, a minimum of 533 pg/L, and a median stormwater concentration of 8,923 pg/L, but that is also based on many of the same in-channel monitoring locations. As a result, the biochars that show some promise for further field testing were exposed to a fairly small range of concentrations that would likely be found at random green infrastructure locations.

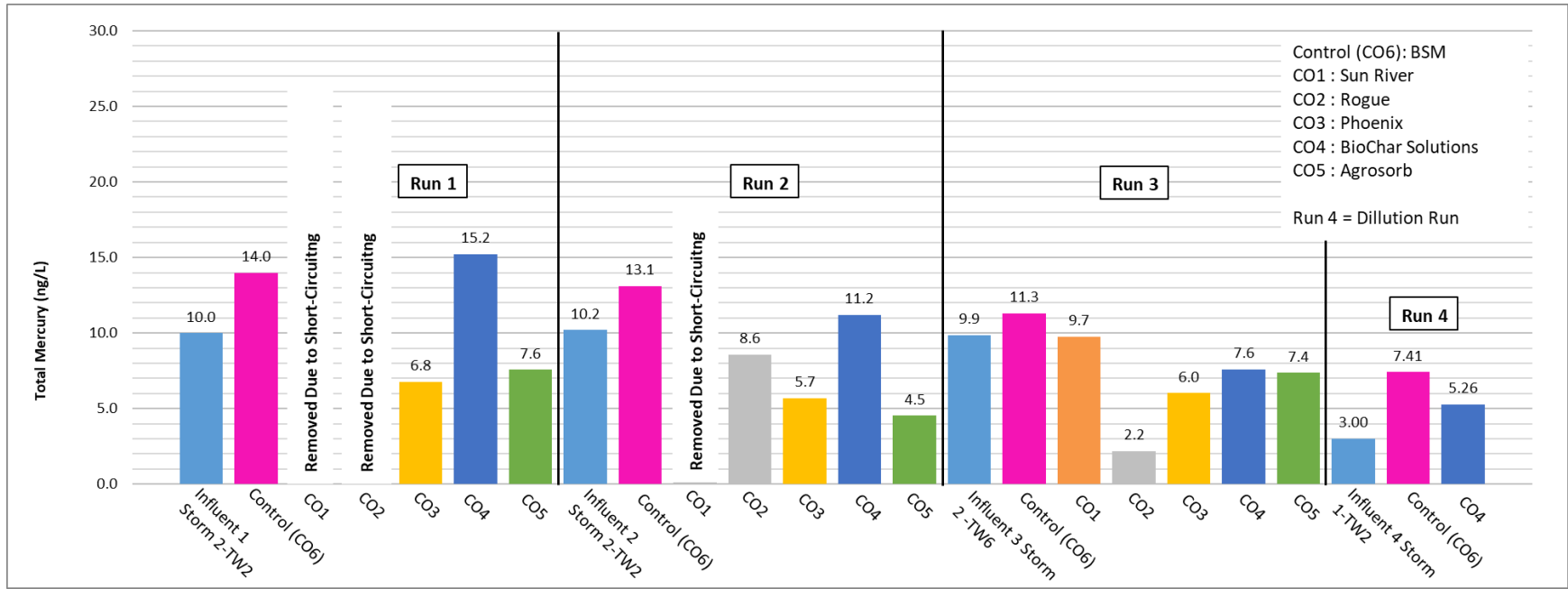

Figure 12. Mercury Concentrations over Time

As stated in the PCB results section, Sunriver biochar-amended BSM (CO1) had unusually high infiltration rates for the first and second test runs and Rogue biochar-amended BSM (CO2) had high rates for the first test run. These data points were removed from the total PCBs dataset for all analyses and were also removed from the mercury dataset.

The mercury export by the control BSM (CO6) for all test runs could indicate that the media itself is releasing mercury. Biochar-amended BSM contain less BSM by volume, which may partially explain the lower mercury concentrations for those columns. Mercury export will likely decrease at locations with higher influent concentrations, and mercury removal is possible if the influent concentration is substantially higher than the export concentration. Gilbreath et al. (2018) reported a median stormwater concentration of 29.2 ng/L, which is almost three times the influent concentration in the three primary test runs.

3.3.3 Other Constituents

Total PCB and mercury concentrations were compared to SSC and TOC respectively. Turbidity was collected during sampling and seasoning runs to provide immediate insight into the performance of the filters throughout the experiment.

Figure 13 shows the relationship between total PCBs and SSC divided into two groups, Influent and Effluent samples.

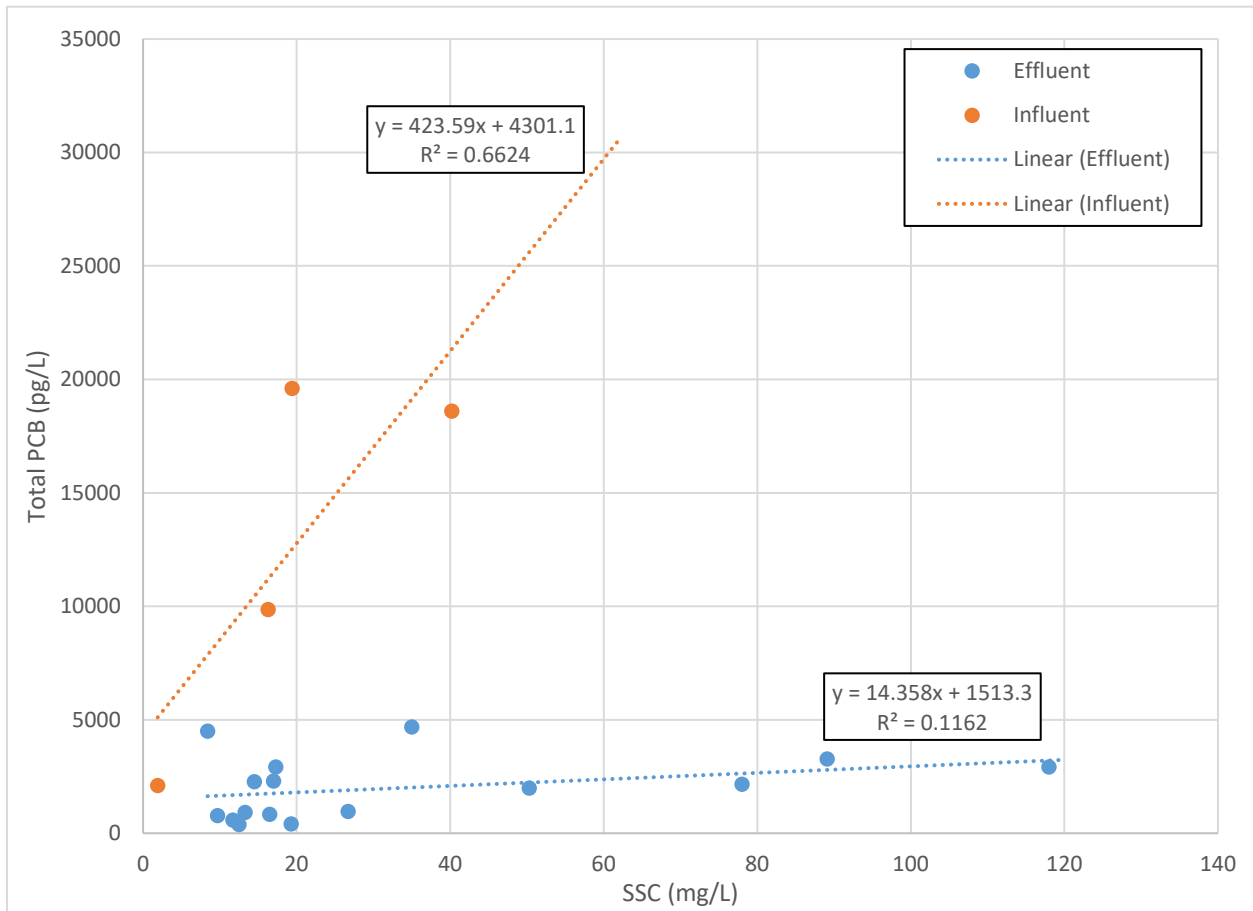

Figure 13. Comparison of Total PCB to SSC Concentrations

Figure 13 confirms the relationship between PCBs and SSC in influent samples (R^2 value of 0.66). The effluent samples have a much shallower regression line with a very low R^2 value of 0.116. This poor correlation is also evidence of contribution of solids from the media rather than the passing of influent solids through the media to the effluent sample, assuming low PCB concentration in the media.

There is no expected correlation between TOC and mercury. It is presented for consideration in cases where methylation is a concern. Figure 14 presents total mercury versus TOC. Normalizing the TOC effluent concentrations by dividing them by influent concentrations shows that TOC at least doubles from influent to effluent, with more typical increases around eight times (Figure 15). This increase is likely from both loss of BSM and leaching of dissolved organic content. Figure 16 shows normalized SSC effluent, which demonstrates substantial export of media, but not as much as TOC. The higher export of TOC is likely due to TOC analysis accounting for particulate and dissolved organic content, while SSC only measures particulates. SSC and TOC increases in these column tests should not be construed as representing field performance. To minimize the concentration reduction in the underdrain, a thin (2-inch) layer of washed coarse sand was used. This underlying coarse sand layer may have exacerbated loss of media solids and consequential increase in TOC and SSC compared to a traditional underdrain with more depth, more fines, and more restriction to infiltration rate.

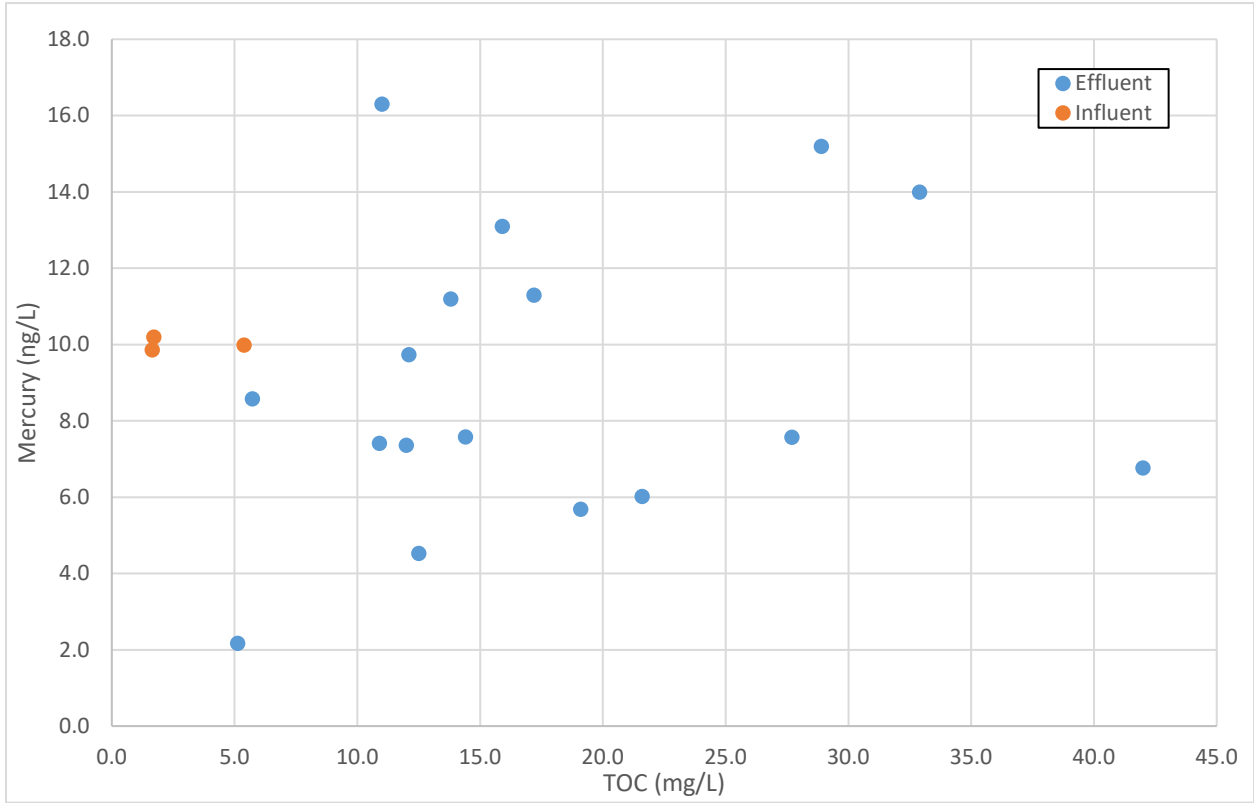

Figure 14. Comparison of Mercury to TOC Concentrations

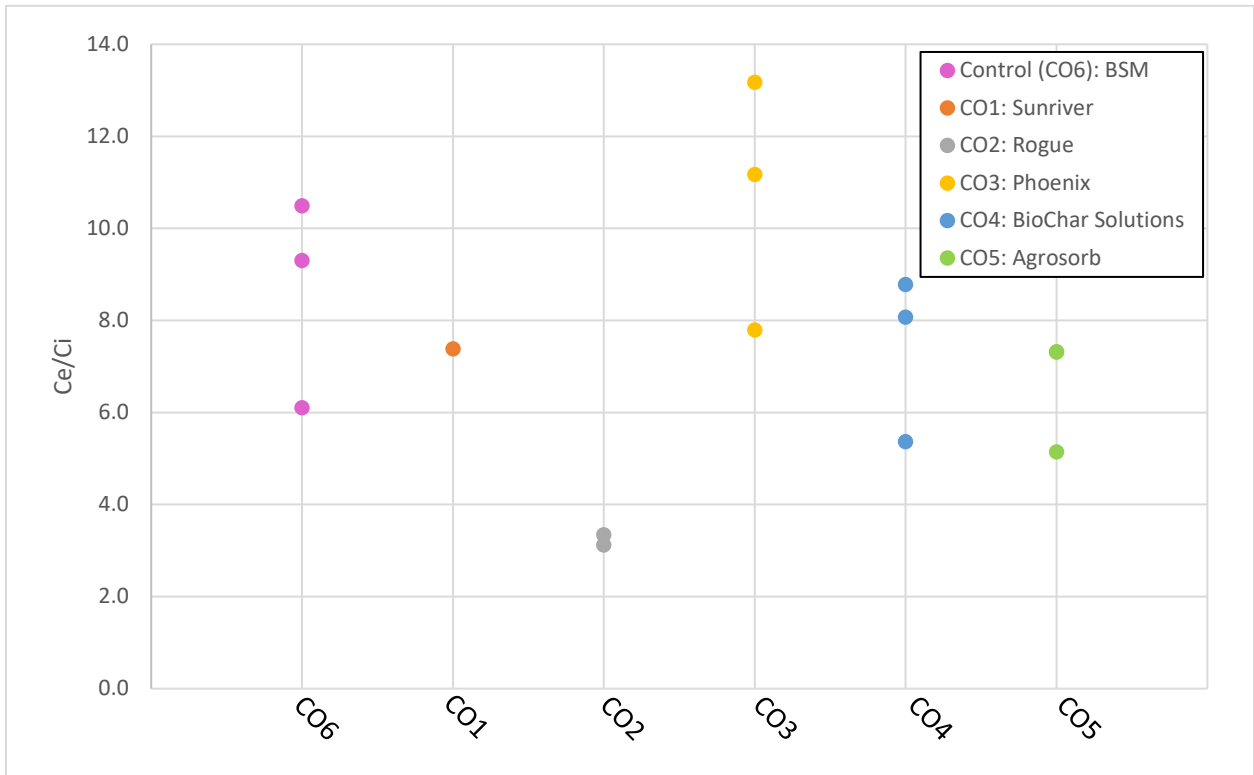

Figure 15. Ce/Ci TOC Concentrations for Column Test Media

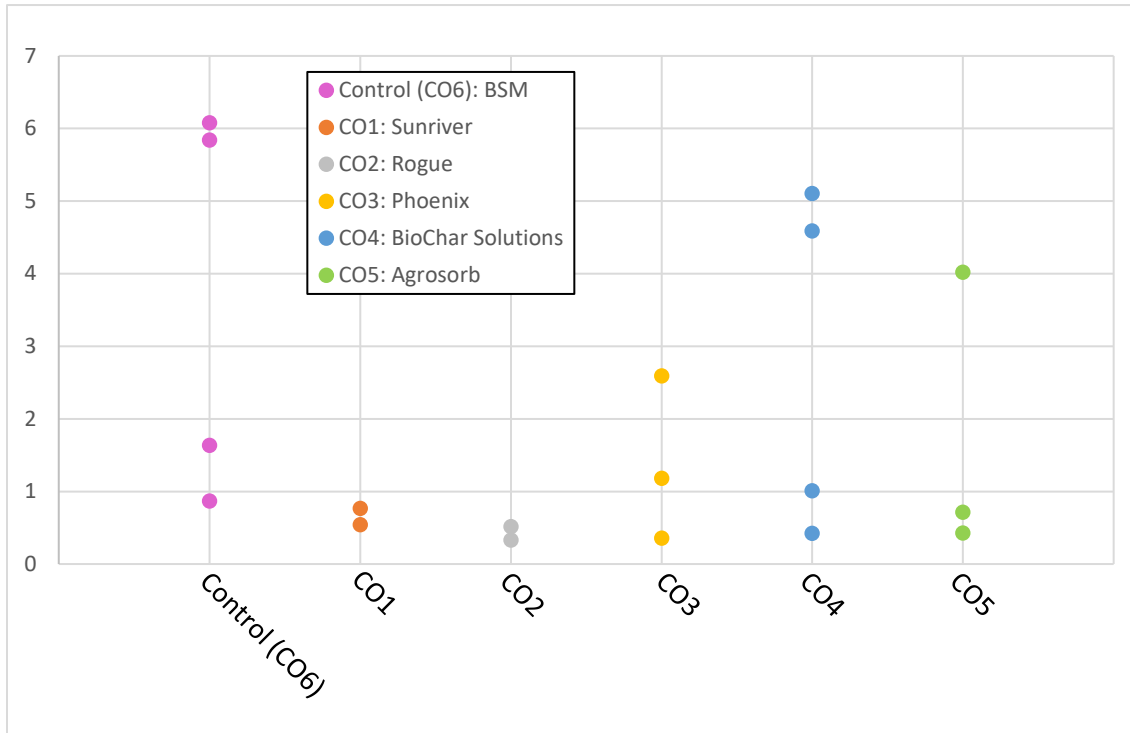

Figure 16. Ce/Ci SSC Concentrations for Column Test Media

Figure 17 shows turbidity measurements for all columns in chronological order over all runs (sampling and seasoning). During the first sampling test run, it was observed that the effluents of all columns had high turbidity and were not representative of a well-established media (see Table 4 for all concentrations). Two seasoning runs were performed next, and the effluent turbidity of all columns stabilized by the end of the second run. Turbidity data is in Appendix F.

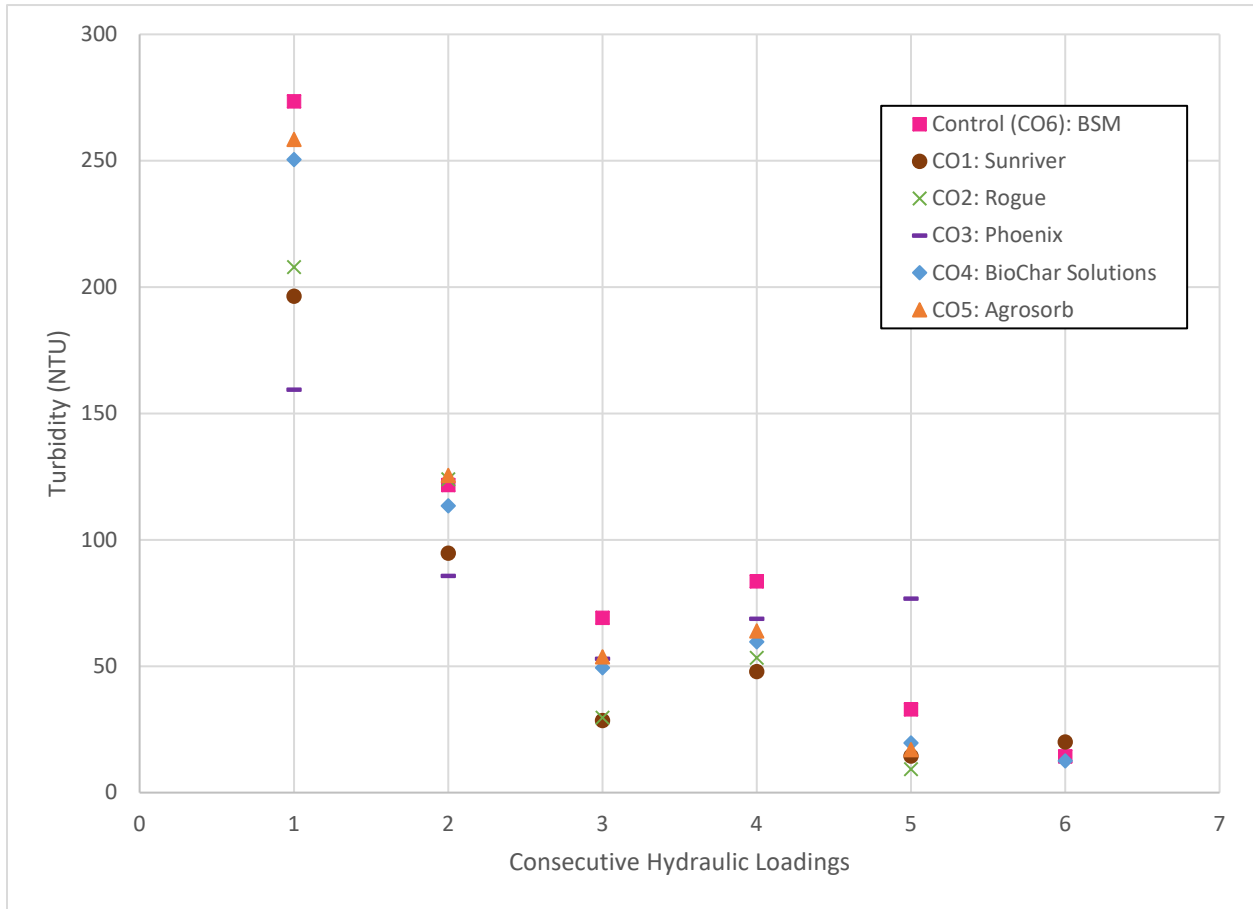

Figure 17. Average Turbidity versus Consecutive Hydraulic Loading (Sampling Runs are labeled 1, 3, 4, 5, and 6 and Seasoning Loading are labeled 2 and 3)

3.4 STATISTICAL TESTS

The statistical analysis (Mann-Whitney U test) on normalized effluent PCB concentrations was unable to establish statistical significance at 90% confidence among media type due to the small sample size, even when grouped by class (e.g., with biochar and without). This also held for mercury. Consequently, further statistical tests were not pursued.

4 CONCLUSIONS AND RECOMMENDATIONS

The goal of this study, as identified in the Monitoring Study Design (Appendix A), was to identify biochar media amendments that improve PCB and mercury load removal by bioretention BMPs. The primary management question supporting that goal was: “Are there readily available biochar-amended BSM that provide significantly better PCB and mercury load reductions than standard BSM and meet MRP infiltration rate requirements?” And the particular purpose of the laboratory testing in this study was: “screen alternative biochar-amended BSM and identify the most promising for further field testing.” This study’s use of bench scale column testing suggests that there may be some utility in pre-testing materials before use in field applications to ensure that they are likely to meet infiltration requirements

at the project site, as well as provide some preliminary evidence of improved or at least equivalent pollutant removal as standard BSM.

4.1 CONCLUSIONS

Nine biochar were readily available from suppliers in the Western United States, and five were tested in this study to compare their impacts on PCBs and mercury concentrations in effluent. All five biochar-BSM blends showed evidence of overall improved PCB and mercury performance compared to the standard BSM for influent concentrations ranging from 9,860 pg/L to 19,600 pg/L⁸. Though performance varied, no biochars could be conclusively eliminated from consideration in future field study. The results support the following observations:

- Phoenix, Sunriver, BioChar Solutions, and Agrosorb appear to offer improved PCB removal compared to standard BSM and the other biochar-amended BSM.
- Phoenix and Agrosorb appear to offer improved mercury removal compared to standard BSM and the other biochar-amended BSM.
- Based on a single run on one column to explore removal at lower influent concentrations, biochar-amended BSM provided removal of PCBs at an influent concentration of 2,100 pg/L. BSM performance at this lower influent concentration could not be reported due to the sample being lost. Neither BSM nor biochar-amended BSM provided removal of mercury at an influent concentration of 3.00 ng/L.
- High initial infiltration rates (associated with short-circuiting and higher pore velocities) correlated to poor performance. Three of four runs with high infiltration rates correlated with poor reduction of PCBs and mercury. All three runs with poor performance (two of which were on one column) occurred prior to a run with a moderate infiltration rate (< 12 in/hr).
- Saturated hydraulic conductivity had poor correlation to the falling head infiltration rates estimated during the water quality sampling runs so biochar that were eliminated from column testing based on saturated hydraulic conductivity tests may be candidates for future testing.

Because the study was a screening level analysis of biochars for potential further study, the limited data for each biochar did not allow for exploration of several factors that are presented in the following section for consideration in development of future study designs.

4.2 RECOMMENDATIONS

Based on this study, biochar shows promise in marginally increasing performance for PCB and mercury removal, however, increased benefit relative to increased cost was not analyzed. With such limited data, meaningful benefit-cost analysis may require collection of substantial field data. Because of the marginal increase in performance, standard BSM should be a component of future side-by-side testing of biochar-amended BSM. Sample size should be selected to provide suitable statistical power to better understand and qualify the performance differences. Other study considerations include long-term performance, media life expectancy, performance for other pollutants, impacts to plant health and water use, and maintenance ramifications. The study team developed the following recommendations for potential biochar testing.

⁸ The lowest influent concentration for Sunriver (CO1) was 8,160 pg/L.

4.2.1 Biochar Selection

For enhanced PCB removal, biochar candidates for further field testing are Phoenix, Sunriver, BioChar Solutions, or Agrosorb. If mercury removal is a design consideration, Phoenix and Agrosorb should be selected over Sunriver and BioChar Solutions. All biochar-amended BSM have falling head drain times in the column tests that were faster than the control BSM, so hydraulic performance should not influence selection. Other factors, such as cost and local sourcing should be considered in final biochar selection. Due to a lack of differentiation of performance and a lack of correlation between performance and cost, less expensive biochar that were not tested here may offer higher benefit/cost. Column tests could provide data for an indication of benefit/cost prior to field testing, but more data is recommended to quantify performance than what was specified in this study for screening-level analysis.

4.2.2 Site Selection

The results of this study could also have implications on site selection for future study. As a general principal, study locations should represent concentrations typical of watersheds that will be receiving green infrastructure, unless those concentrations are below the irreducible concentration. The data indicate that irreducible PCBs concentrations may be occurring around 1,000 pg/L. It is unclear for total mercury. Data from other studies in the San Francisco Bay Area should be consulted to develop a better estimate of irreducible concentrations so future study can avoid areas that are too clean for the technology to be effective for these pollutants.

4.2.3 Outlet Control

Outlet control may be the most important factor in performance. Outlet controls minimize short-circuiting (preferential flow paths) and they increase contact time. Elevated outlets can also increase contact time in between storm events, but this may also affect mercury speciation by providing an anoxic environment where methylation may occur. Further study should control for both contact time and presence of biochar to determine which has the greatest effect in field conditions. Further investigation into contact time (i.e., infiltration rates) and underdrain behavior at the CW4CB biochar location may also be helpful in development of future study plans.

4.2.4 Saturated Hydraulic Conductivity Testing Requirements

The representativeness and utility of the saturated hydraulic conductivity test under typical compaction conditions for highly organic and friable material may be a matter worth discussion within the appropriate BASMAA bioretention working groups. Use of outlet control could obviate the verification of the upper-end conductivity. A lower-end conductivity may still be recommended to assure that the outlet control governs flow rather than the media.

5 REFERENCES

BASMAA. 2016. Specification of soils for Biotreatment of Bioretention Facilities. Bay Area Stormwater Management Agencies Association.

BASMAA. 2017. Clean Watersheds for a Clean Bay Project Report, Final Report. Bay Area Stormwater Management Agencies Association. May 2017.

Gilbreath, A.N., Wu, J., Hunt, J.A., and McKee, L.J., 2018. Pollutants of concern reconnaissance monitoring final progress report, water years 2015, 2016, and 2017. A technical report prepared for the Regional Monitoring Program for Water Quality in San Francisco Bay (RMP). Contribution No. 840. San Francisco Estuary Institute, Richmond, California.

Gomez-Eyles, J. L., C. Yupanqui, B. Beckingham, G. Riedel, C. Gilmour, and U. Ghosh. 2013. "Evaluation of Biochars and Activated Carbons for In Situ Remediation of Sediments Impacted with Organics, Mercury, and Methylmercury." *Environ. Sci. Technol.*, 47, 13721–13729.

Kitsap County. 2015. Analysis of Bioretention Soil Media for Improved Nitrogen, Phosphorus and Copper Retention, Final Report. Kitsap County Public Works, Washington.

McKee, L.J. Gilbreath, N., Hunt, J.A., Wu, J., and Yee, D., 2015. Sources, Pathways and Loadings: Multi-Year Synthesis with a Focus on PCBs and Hg. A technical report prepared for the Regional Monitoring Program for Water Quality in San Francisco Bay (RMP), Sources, Pathways and Loadings Workgroup (SPLWG), Small Tributaries Loading Strategy (STLS). SFEI Contribution No. 773. San Francisco Estuary Institute, Richmond, CA.

SFB Regional Water Board. 2015. Municipal Regional Stormwater NPDES Permit, Order No. R2-2015-0049. NPDES Permit No. CAS612008. November 19, 2015

APPENDIX A: MONITORING STUDY DESIGN

POC Monitoring for Management Action Effectiveness

Monitoring Study Design

Final, September 2017

Prepared for:



Prepared by:



1410 Jackson Street
Oakland, California
94612



WATER PROGRAMS
SACRAMENTO STATE

6000 J Street
Sacramento, California
95819



4911 Central Avenue
Richmond, California
94804

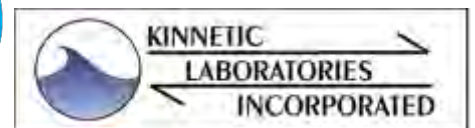

307 Washington Street
Santa Cruz, California
95060

Contents

	List of Tables	3
	List of Figures	3
1.	Introduction.....	4
2.	Problem Definition	5
	2.1 HDS Units.....	5
	2.2 Bioretention	7
3.	Study Goals.....	10
	3.1 Primary Management Questions	10
	3.2 Secondary Management Questions	10
	3.3 Level of Confidence.....	11
4.	Study Design Options.....	12
	4.1 Influent-Effluent Monitoring.....	13
	4.2 Sediment Sampling	14
	4.3 Before-After Monitoring	15
5.	Primary Data Objectives.....	16
	5.1 Data Objective 1: Annual Loads Captured by HDS Units	16
	5.2 Data Objective 2: Loads Reduced by Biochar-Amended BSM.....	16
6.	BMP Processes and Key Study Variables.....	18
	6.1 HDS Units.....	19
	6.2 Bioretention	20
7.	Monitoring and Sampling Options.....	21
	7.1 HDS Units.....	21
	7.1.1 Influent Quality.....	21
	7.1.2 BMP Design and Hydraulic Loading	24
	7.1.3 Operation and Maintenance	26
	7.2 Enhanced Bioretention	26
	7.2.1 Influent Quality.....	26
	7.2.2 BMP Design and Hydraulic Loading	27
	7.2.3 Media Type and Properties.....	27
	7.2.4 Operation and Maintenance Parameters	29
	7.3 Uncontrolled Variables and Study Assumptions	29
8.	Final Study Design	31
	8.1 Statistical Testing & Sample Size	31
	8.2 Constituents for Sediment Analysis	31
	1 – Only total mercury analyzed. Methyl mercury is not	32
	relevant for SF Bay TMDL	32
	8.3 Constituents for Water Quality Analysis.....	32
	1 – Only total mercury analyzed. Methyl mercury is not	33
	relevant for SF Bay TMDL	33
	8.4 Budget and Schedule	33
	8.5 Optimized Study Design	33
	8.6 Adequacy of Study Design	37
9.	Recommendations for Sampling and Analysis Plans.....	39

9.1	HDS Monitoring	39
9.2	Enhanced Bioretention Media Testing	39
9.3	Data Quality Objectives	40
10.	References	41

List of Tables

Table 2.1	Summary of Data Collected from Leo Avenue HDS during October, 2014 Annual Cleanout Event.....	6
Table 2.2	Summary of Bay Area Drain Inlet Sediment Concentration Data.....	6
Table 7.1	HDS Sampling Design based on Watershed Land Use	22
Table 7.2	Percent of Land Use in HDS Watershed Areas.....	23
Table 7.3	HDS Sampling Design based on Predominant Land Use	24
Table 7.4	HDS Sampling Design based on Predominant Land Use and HDS Size	25
Table 7.5	Example Sampling Design for Laboratory Column Experiments	28
Table 8.1	Selected Constituents for HDS Sediment Monitoring	32
Table 8.2	Selected Aqueous Constituents for Media Testing in Laboratory Columns	33
Table 8.3	HDS Monitoring Study Design.....	35
Table 8.4	Enhanced BSM Testing Study Design	36

List of Figures

Figure 2.1	Cumulative Frequency Distribution of Total PCBs Influent Concentrations for Bioretention Media with and without Biochar.....	8
Figure 4.1	Typical BMP system and pollutant pathways	12
Figure 4.2	Comparison of two hypothetical non-overlapping BMP regressions.....	14
Figure 7.1	Land Use based PCB and Mercury Loading based on BASMAA Integrated Monitoring Reports (SFEI, 2015).....	22

1. Introduction

Discharges of PCBs and mercury in stormwater have caused impairment to the San Francisco Bay estuary. In response, the Regional Water Board adopted total maximum daily loads (TMDLs) to address these pollutants of concern (POC) (SFBRWQCB, 2012). Provisions C.11 and C.12 the Municipal Regional Stormwater NPDES Permit, MRP (SFBRWQCB, 2015) implement the Mercury and PCB Total Maximum Daily Loads (TMDLs) for the San Francisco Bay Area. These provisions require mercury and PCB load reductions and the development of a Reasonable Assurance Analysis (RAA) demonstrating that control measures will be sufficient to attain the TMDL waste load allocations within specified timeframes. Provision C.8.f of the MRP supports implementation of the mercury and PCB TMDLs provisions by requiring that Permittees conduct pollutants of concern (POC) monitoring to address the five priority information needs listed below.

1. *Source Identification* – identifying which sources or watershed source areas provide the greatest opportunities for reductions of POCs in urban stormwater runoff;
2. *Contributions to Bay Impairment* – identifying which watershed source areas contribute most to the impairment of San Francisco Bay beneficial uses (due to source intensity and sensitivity of discharge location);
3. *Management Action Effectiveness* – providing support for planning future management actions or evaluating the effectiveness or impacts of existing management actions;
4. *Loads and Status* – providing information on POC loads, concentrations, and presence in local tributaries or urban stormwater discharges; and
5. *Trends* – evaluating trends in POC loading to the Bay and POC concentrations in urban stormwater discharges or local tributaries over time.

Table 8.2 of Provision C.8.f identifies the minimum number of samples that each MRP Countywide Program (i.e., Santa Clara, San Mateo, Alameda, and Contra Costa) must collect and analyze to address each monitoring priority. Although individual Countywide monitoring programs can meet these monitoring requirements, some requirements can be conducted more efficiently and will likely yield more valuable information if coordinated and implemented on a regional basis. The minimum of eight (8) PCB and mercury samples required by each Program to address information priority #3 is one such example. Findings from a regionally-coordinated monitoring effort would better support development of the RAA.

This Study Design describes monitoring and sample collection activities designed to meet the requirements of information priority #3 of Provision C.8.f of the MRP. The activities planned include field sampling of hydrodynamic separators and laboratory experiments with amended bioretention soils. Study planning is important to ensure that the right type of data are collected and there is a sufficient sample size and power to help address the management questions within the available time and budget constraints. Essential components of the study plan include describing problems, defining study goals, identifying important study parameters, specifying methodologies, and validating and optimizing the study design.

2. Problem Definition

Studies conducted to date have identified PCB source areas in the Bay Area where pollutant management options may be feasible and beneficial. Enhanced municipal operational PCB management options (e.g., street sweeping, storm drain line cleanout) have the advantage of being familiar and well-practiced, address multiple benefits, and the cost-benefit may exceed that for stormwater treatment (BASMAA, 2017a). Site-specific stormwater treatment via bioretention, however, is now commonly implemented to meet new and redevelopment (MRP Provision C.3) requirements. An added benefit of redevelopment is that PCB-laden sediment sources can be immobilized. However, many areas where certain land uses or activities generate higher PCB concentrations in runoff are unlikely to undergo near-term redevelopment, and instead may only be subject to maintenance operations or stormwater BMP retrofit projects implemented by the municipality. Consequently it is valuable to maximize cost effective PCB removal benefit of both operations and maintenance, and stormwater treatment.

Two treatment options that have the potential to reduce PCB discharges include hydrodynamic separators (HDS units) and enhanced bioretention filters. These options were pilot-tested in the Clean Watersheds for a Clean Bay (CW4CB) Project (BASMAA, 2017a). HDS units are being implemented for trash control throughout the Bay Area and collect sediment to some extent along with trash and other debris. Quantifying PCB mass removed by these units will help MRP Permittees account for the associated load reductions. For these and other control measures, an Interim Accounting Methodology has been developed based on relative mercury and PCBs yields from different land use categories (BASMAA, 2017c). Bioretention is a common treatment practice for new development and redevelopment in the San Francisco Bay Area, so enhancing the performance of bioretention is also attractive.

At this time reducing mercury loads in stormwater runoff is a lower priority than PCBs load reduction. The assumption during the MRP 2.0 permit term is that actions taken to reduce PCBs loads in stormwater runoff are generally sufficient to address mercury. Therefore, optimizing stormwater controls for PCBs is the primary focus in this study.

2.1 HDS Units

Limited CW4CB monitoring conducted at two HDS sites was used to calculate the mass of PCBs in trapped sediment (BASMAA, 2017a). The two sites sampled were Leo Avenue in San Jose and City of Oakland Alameda and High Street. The Leo Avenue HDS unit treats runoff from approximately 178 acres of watershed with a long history of industrial land uses, including auto repair and salvage yards, metal recyclers, and historic rail lines. The City of Oakland Alameda and High Street HDS has a tributary drainage area of approximately 35 acres with a high concentration of old industrial and commercial land uses, including historic rail lines.

Sampling of the two CW4CB HDS units was opportunistic and associated with scheduled cleanouts. Two sump cleanout events took place in August 2013, one at the Leo Avenue HDS unit and one at the Alameda and High Street HDS unit. However, due to a lack of captured sediment the samples collected were aqueous phase samples instead of sediment samples. An additional cleanout took place at Leo Avenue in October 2014. A sump sediment sample

collected and analyzed during this cleanout contained total PCB concentrations of 1.5 mg/kg and mercury concentrations of 0.33 mg/kg for sediment less than 2 mm in size, and estimated annual total PCB and mercury removals were 375 mg and 82.4 mg, respectively (Table 2.1). The HDS sediment concentrations are comparable to previous Leo Avenue watershed measurements in sediments from piping assessed via manholes, drop inlets/catch basins, streets/gutters, and private properties (ND to 27 mg/kg for PCBs and 0.089 to 6.2 mg/kg for mercury) (BASMAA, 2014). At the Alameda and High Street HDS unit, tidal influences of Bay water prevented additional monitoring.

Table 2.1 Summary of Data Collected from Leo Avenue HDS during October, 2014 Annual Cleanout Event

Parameter	Result	Units
Volume of Sediment Removed	4	Cubic yards
Total PCBs Concentration	1.5	mg/Kg
Mercury Concentration	0.33	mg/Kg
Bulk density	0.67	g/cm ³
Percent solids	39	%
Particle Size (< 2 mm)	31	%

There are no known published studies characterizing HDS sediment for PCBs or mercury, so the Leo Avenue results are compared to relevant drain inlet/catch basin sediment studies. In the Bay Area, different municipalities have collected and analyzed drain inlet cleaning sediment samples. The analytical results for these drain inlet sediment samples are summarized in Table 2.2 (BASMAA, 2014). As can be seen from Table 2.2, the Leo Avenue sediment PCB concentrations are higher than those measured in Bay Area drain inlet sediment by up to an order-of-magnitude, but mercury concentrations are comparable.

Table 2.2 Summary of Bay Area Drain Inlet Sediment Concentration Data

(Based on readily available data; see BASMAA (2016b) for additional summaries for street and storm drain sediment)

Municipality	PCBs			Mercury		
	No. Drain Inlet Sediment Samples	Mean PCB DI Sediment Concentration (mg/Kg)	Median PCB DI Sediment Concentration (mg/Kg)	No. Drain Inlet Sediment Samples	Mean Mercury DI Sediment Concentration (mg/Kg)	Median Mercury DI Sediment Concentration (mg/Kg)
Fairfield & Suisun	8	0.244	0.055	16	0.510	0.228
San Mateo County Municipalities	29	0.318	0.123	28	0.160	0.147
San Carlos	22	0.267	0.129	25	0.167	0.147
Alameda County Municipalities	47	0.294	0.122	75	0.384	0.204
Berkeley	8	0.147	0.122	11	0.343	0.241
Oakland	24	0.402	0.155	28	0.539	0.297
San Leandro	11	0.219	0.106	21	0.230	0.151
Contra Costa County Municipalities	46	0.515	0.168	48	0.413	0.308
Richmond	31	0.736	0.482	28	0.460	0.349

Notes:

Mean and median drain inlet sediment concentrations were calculated from the SFEI database (SFEI 2010, KLI and EOA 2002; City of San Jose and EOA 2003).

Monitoring by the City of Spokane, Washington, showed total PCBs in catch basin sediment ranged between 0.025 mg/kg and 1.7 mg/kg for an industrial area with known PCB contamination (City of Spokane, 2015). A City of San Diego study characterized sediments in eight catch basins in a 9.5 acre area of downtown San Diego classified as high density mixed use with roads, sidewalks, and parking lots (City of San Diego, 2012). Concentrations of common aroclors in the catch basin sediments varied from about 0.040 to over 0.9 mg/kg. Monitoring by the City of Tacoma showed PCB concentrations in stormwater sediment traps varied from nondetect to a maximum near 2 mg/kg (City of Tacoma, 2015). The highest PCB concentrations in catch basin sediments ranged from 16 mg/kg in downtown Tacoma to 18 mg/kg in East Tacoma. These published drain inlet/catch basin studies show that PCB and mercury concentrations can vary substantially in storm drain sediments depending on the characteristics of the watershed.

Sampling of captured sediment at the Leo Avenue HDS in San Jose highlighted the potential of HDS maintenance as a management practice for controlling PCB and mercury loads. The BASMAA Interim Accounting Methodology that is currently being used to calculate load reductions assumes a default 20% reduction of the area-weighted land-used based pollutant yields for a given catchment. This default value was based on average percent removal of TSS from HDS units based on analysis of paired influent/effluent data. However, significant data gaps remain in determining the effectiveness of this practice and expected load reductions. HDS sediment sampling has been limited to a few samples. PCB concentrations in the Leo Avenue HDS sample were much higher than average concentrations in Bay Area drain inlet sediment. Drain inlet/catch basin sediment sampling by others suggests that sediment PCB and mercury concentrations can vary substantially from watershed to watershed. **The monitoring performed to date is not sufficient to characterize pollutant concentrations of sediment captured in HDS units that drain catchments with different loading scenarios (e.g., land-uses, stormwater volumes, etc.), nor to estimate the percent removal based on the pollutant load captured by the HDS unit. Additional sampling is needed to better quantify the PCB and mercury loads capture by these devices, and calculate the percent removal achieved.** Consequently, quantification of PCBs removed at other HDS locations and evaluation of the percent load reduction achieved is needed to provide better estimates of PCB load reductions from existing HDS unit maintenance practices.

2.2 Bioretention

The results of monitoring the performance of bioretention soil media (BSM) amended with biochar at one CW4CB pilot site suggest that the addition of biochar to BSM is likely to increase removal of PCBs in bioretention BMPs. Biochar is a highly porous, granular material similar to charcoal. In the CW4CB study, the effect of adding biochar to BSM was evaluated using data collected from two bioretention cells (LAU 3 and LAU 4) at the Richmond PG&E Substation 1st and Cutting site. At this site, cell LAU 3 contains standard engineered soil mix (60% sand and 40% compost) while cell LAU 4 contains a mix of 75% standard engineered soil and 25% pine wood-based biochar (by volume).

Figure 2.1 shows a cumulative frequency plot of influent and effluent PCB concentrations for the two bioretention cells. Although influent PCB concentrations at the two cells were generally similar, effluent PCB concentrations were much lower for the enhanced bioretention

cell (LAU 4) compared to those for the standard bioretention cell (LAU 3). The results for total mercury were different from those for PCBs, with both cells demonstrating little difference between influent and effluent concentrations. These CW4CB monitoring results suggest that the addition of biochar to BSM may increase removal of PCBs but not mercury from stormwater. However, analysis of methylmercury indicated that BSM may encourage methylation while biochar may mitigate the effect such that there is no substantial transformation of mercury to methylmercury. Tidal influences at 1st and Cutting also may be a contributing factor that should be controlled in future study.

The majority of biochar research conducted to date has focused on agricultural applications, where biochar has been shown to improve plant growth, soil fertility, and soil water holding, especially in sandier soils. Only a handful of field-scale projects have investigated the effects of biochar in stormwater treatment and no known field studies have investigated removal of mercury or PCBs from stormwater by biochar-amended media.

A recent laboratory study on the effect of biochar addition to contaminated sediments showed that biochar is one to two orders of magnitude more effective at removing PCBs from soil pore water than natural organic matter, and may be effective at removing methylmercury but not total mercury (Gomez-Eyles et al., 2013). A laboratory column testing study to determine treatment effectiveness of 10 media mixtures showed that a mixture of 70% sand/20% coconut coir/10% biochar was one of the top performers and cheaper than similarly effective mixtures using activated carbon (Kitsap County, 2015). Liu et al (2016) tested 36 different biochars for their potential to remove mercury from aqueous solution and found that concentrations of total mercury decreased by >90% for biochars produced at >600°C but about 40–90% for biochars produced at 300°C.

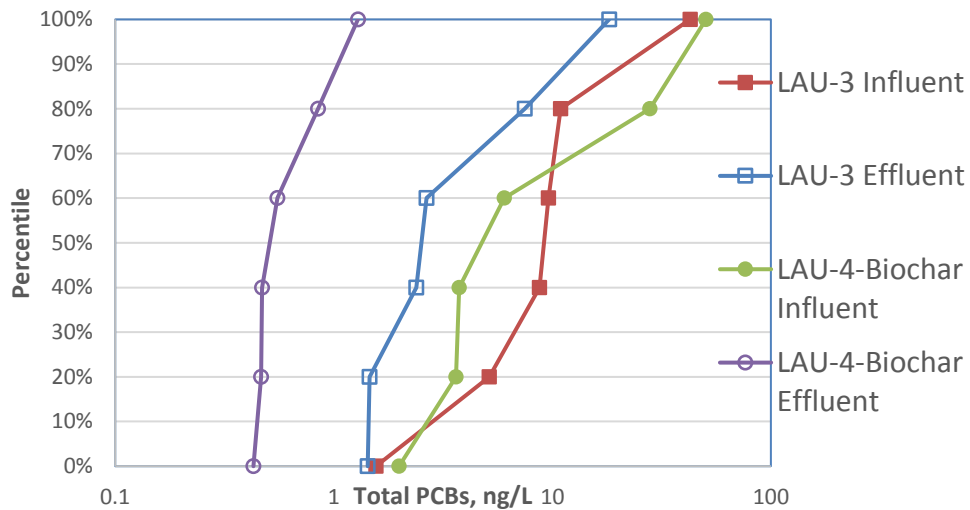

Figure 2.1 Cumulative Frequency Distribution of Total PCBs Influent Concentrations for Bioretention Media with and without Biochar

Monitoring of two bioretention cells at the Richmond PG&E Substation 1st and Cutting pilot site showed greater PCB removal for a biochar-amended BSM than that for standard BSM.

However, to date sampling has been limited to one test site and one biochar amendment, and the operational life of the amended media is unknown. **Besides the CW4CB study, there are no published literature studies on field PCB and mercury removal for biochars. Additional field testing can confirm the effectiveness of bioretention implementation in more typical conditions, and laboratory testing is recommended as an initial screening to help identify potential biochars for field testing.** Laboratory testing using actual stormwater from the Bay Area can be a cost-effective screening tool to identify biochar media that are effective for PCB removal, do not exacerbate mercury problems or even improve mercury removal, and meet operational requirements, including an initial maximum infiltration rate of 12 in/h and a minimum long-term infiltration capacity of 5 in/h.

3. Study Goals

The goals of this study identified from the problem statements are as follows:

1. Quantify annual PCB and mercury load removals during maintenance (cleanout) of HDS units
2. Identify biochar media amendments that improve PCB and mercury load removal by bioretention BMPs

To reach these goals, the following management questions are prioritized as primary or secondary management questions.

3.1 Primary Management Questions

A properly conceived study will address the study goals in a manner that supports planning for future management actions or evaluating the effectiveness or impacts of existing management actions. The resulting primary management questions focus on performance and are:

1. What are the average annual PCB and mercury loads captured by existing HDS units in Bay Area urban watersheds?
2. Are there readily available biochar-amended BSM that provide significantly better PCB and mercury load reductions than standard BSM and meet MRP infiltration rate requirements?

The MRP infiltration rate requirements are described in Provision C.3.c of the MRP (SFBRWQCB, 2015). This provision states the following: “Biotreatment (or bioretention) systems shall be designed to have a surface area no smaller than what is required to accommodate a 5 inches/hour stormwater runoff surface loading rate, infiltrate runoff through biotreatment soil media at a minimum of 5 inches per hour, and maximize infiltration to the native soil during the life of the Regulated Project. In addition to the 5 inches/hour MRP requirement, for non-standard BSM the recently updated BASMAA specification requires “certification from an accredited geotechnical testing laboratory that the bioretention soil has an infiltration rate between 5 and 12 inches per hour” (BASMAA, 2016a).

3.2 Secondary Management Questions

Secondary management questions are helpful, but they are not critical to the usefulness of the study. Study scope, budget, and schedule constraints limit the extent to which they can be addressed. Possible secondary management questions include the following:

HDS

1. How does sizing of HDS units affect annual PCB and mercury loads captured in HDS sediment?
2. Do design differences between HDS units (e.g., single vs multiple chambers) result in significant differences in pollutant capture?
3. How does the frequency of cleanout of HDS units affect load capture?

4. If present, does washout of HDS sediment depend on remaining sediment volume capacity?
5. Are there significant concentrations of PCBs in the pore (interstitial) water of HDS sediment?
6. Are PCBs and mercury removal correlated to removal of better-studied surrogate constituents, such as TSS?
7. Is there evidence of increased methylation within HDS sediment chambers?

Enhanced Bioretention

1. How does biochar performance vary with feedstock?
2. How does biochar performance vary with manufacturing method?
3. Should the biochar be mixed with the BSM or provided as a separate layer below the standard BSM?
4. Does biochar have leaching issues or require conditioning before use?
5. How long does the improved performance of biochar-amended BSM last?
6. Does the promising media increase methylation of mercury?
7. What is the expected increase in BSM costs due to inclusion of media amendment?
8. Does knowledge of the association of PCBs and mercury to specific particle sizes improve understanding of performance?
9. Is mass removal comparable to that expected from a conceptual understanding of removal mechanisms?

The above secondary management questions are provided as examples, and the questions answered will depend on budget, schedule, and actual data collected.

3.3 Level of Confidence

The level of confidence in the answers to the above management questions depends on sample representativeness and size. Samples are considered representative if they are derived from sites or test conditions that are representative of the watershed or treatment being considered. A power analysis can be used after monitoring commences or at the end of a study to determine if sample size is sufficient to draw statistically valid conclusions at a pre-selected level of confidence. Power analysis can also be used prior to study commencement, but its usefulness in estimating sample size requirements may be limited by lack of knowledge of variability in the biochar-amended BSM data to be collected.

Level of confidence can also be assessed in terms of consistency of treatment (e.g., a particular biochar consistently shows better removals than other biochars for a variety of stormwaters), which can be assessed with non-parametric approaches such as a sign-rank test.

Data analysis approaches are discussed in Section 8.5.

4. Study Design Options

An overview of the available study designs is presented here to understand the methods, value, and constraints of each design. This information is helpful in identifying which study designs are appropriate for the various management questions. To answer the primary management questions, the mass of pollutants captured must be quantified. This is accomplished by monitoring pollutant input and export for each HDS unit or media option, or directly quantifying captured pollutant. For example, the typical input and output pathways for a stormwater treatment measure (i.e., BMP) are illustrated in **Error! Reference source not found.4.1**. This overview describes how data are collected and how they are used to answer the primary study questions.

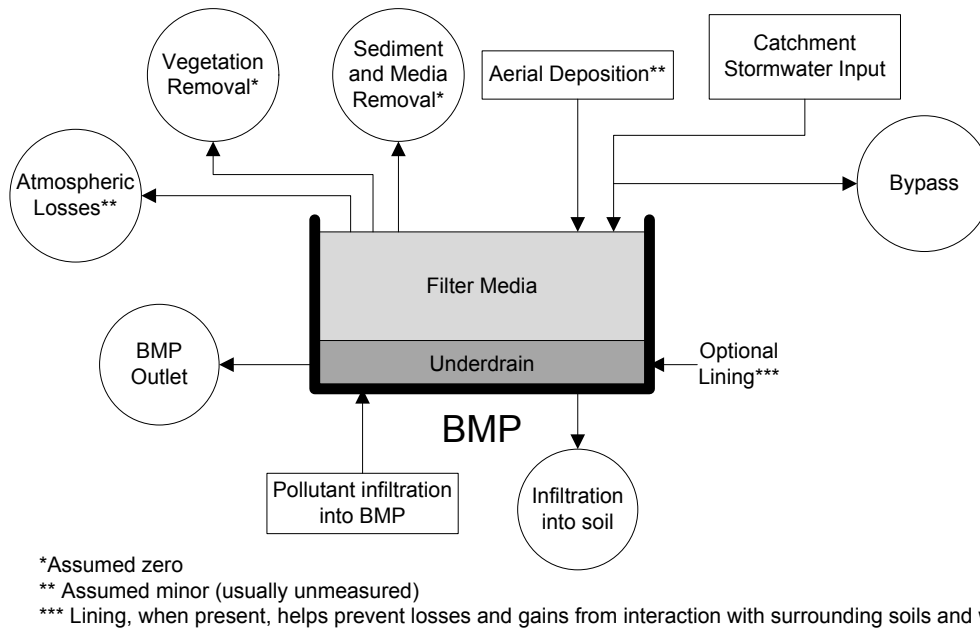

Figure 4.1 Typical BMP system and pollutant pathways

The study designs discussed here address major inputs and losses, but not all. Selection of study design is based on the management questions, the type of BMP(s), the study constraints, and the current and historic conditions of the study area. Each type of study has associated strengths and weaknesses as described below:

- **Influent-effluent monitoring**
 Influent and effluent monitoring tests water going into and discharging from a selected BMP or treatment option for a particular storm event. This approach is typically used to assess BMP effectiveness. An advantage of this approach is its ability to discern differences in limited data sets. A weakness of this approach is that measured load reductions may not be representative of true load reductions if there is infiltration to the native soil, baseflow entering the BMP, or bypass flows that are not monitored

- Sediment sampling
Sediment sampling occurs within the BMP or treatment option and is used to estimate cumulative load removed over several storms. Sediment sampling can occur in dry periods.
- Before-after monitoring
Before-after monitoring occurs at the same location. In the before-after approach, data are collected at some location, a change is made (i.e., a BMP is implemented or modified), and additional data are then collected at the same location. This introduces variability because in field monitoring the storms monitored before BMP implementation may not have the same characteristics as those after implementation.
- Paired watershed monitoring
Paired watershed attempts to characterize two watersheds that are as similar as possible, except one has BMP treatment (e.g., an HDS unit). The paired watershed approach is typically used when monitoring the influent of the BMP is infeasible. While the storms monitored are the same, inevitable differences in the watersheds often lead to unexplainable variability.

Paired watershed monitoring is not discussed further because it is not applicable to this study. The scope of work does not require influent monitoring at field sites or monitoring of paired sites without BMPs.

Volume measurement is critical to estimating load removal efficiency for BMPs that have volume losses. Volumes can be measured at influent, effluent, and bypass locations and within the BMP for individual storms or over a longer period.

The following subsections provide more detail on each monitoring approach.

4.1 Influent-Effluent Monitoring

Comparison of influent and effluent water quality and load is the method most often used in studies of treatment BMPs. This method is used to estimate the pollutant removal capability of field devices such as individual BMPs or a series of in-line BMPs (i.e., a treatment train) or laboratory treatment systems such as filter media columns. This type of study results in paired samples. Paired samples are beneficial because fewer samples are needed to show statistically significant levels of pollutant reduction compared to unpaired samples. This can result in substantial cost savings for sample collection and sample analysis.

Comparison of performance among BMPs may not be possible if there are only a limited number of locations because of different influent qualities. This is illustrated in **Error! Reference source not found.** for two non-overlapping BMP data sets, which show confidence intervals for effluent estimates (vertical dashed and dotted lines with arrows) expand as the distance between the hypothetical influent x-value and the mean x-value of the data increases. Although the effluent estimates at a common influent concentration (solid black square and diamond) may reflect true effluent qualities, confidence in these predictions is low because of this extrapolation and the performance of the two BMPs may not be statistically distinguishable. A better study design is one that selects sites with similar influent

characteristics or ensures collection of a sufficient number of samples at or close to the common influent level.

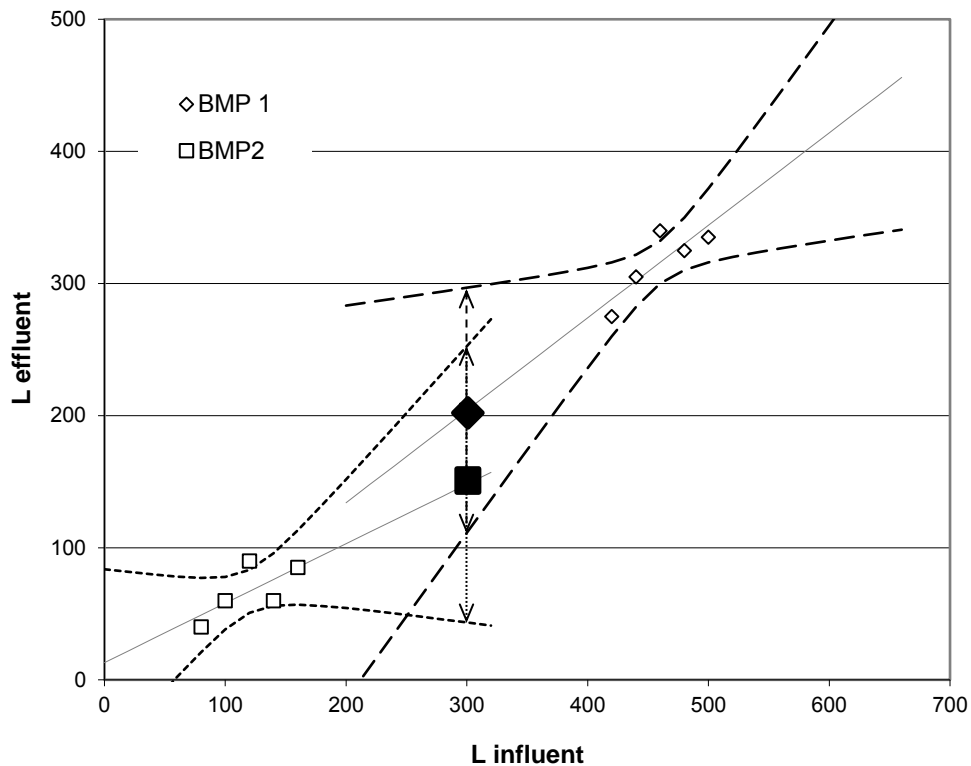

Figure 4.2 Comparison of two hypothetical non-overlapping BMP regressions

4.2 Sediment Sampling

Sediment sampling involves taking samples of actual sediment captured in a BMP in lieu of influent and effluent monitoring. Analysis of the accumulated sediment can provide estimates of the total mass of conservative pollutants removed¹. An advantage of sediment sampling is reduced cost because expensive storm event sampling is not required. Another advantage is that the measure of pollutants is direct and it is not possible to obtain negative results as in the case of sampling highly variable influent/effluent.

There are a number of limitations to sediment sampling. Annual sediment sampling during a maintenance interval generates fewer data points than influent-effluent sampling throughout a storm season, so comparisons among BMP factors (design, loading, etc.) may require a greater number of monitoring sites. Another limitation is that influent monitoring data are not available to describe how the mass removal estimates may be sensitive to influent loading, and influent monitoring may be required in addition to sediment sampling to

¹ In the context of sediment sampling, “conservative pollutants” are those that are not substantially lost to volatilization or plant uptake in between periods of sediment analysis. Sediment analysis underestimates performance where volatilization or plant uptake is substantial.

characterize pollutant loading. This limitation is addressed in this study during the data analysis by using model estimates of stormwater flows and pollutant loads from each HDS unit catchment to provide estimates of the influent and associated percent removals achieved.

Another limitation of sediment sampling is the potential error resulting in non-homogeneous pollutant distribution within the sediment. Compositing multiple samples will better characterize the sediment, much as the collection of several aliquots throughout a stormwater runoff event can better represent the total volume of water. Mixing the removed sediment before compositing can provide samples that are more homogeneous.

Consequently, the effectiveness of sediment sampling depends on the type of BMP. HDS are the best candidates for sediment sampling. The sumps are cleaned and empty at the start of the study, and the entire mass of retained sediment is removed at each maintenance event (sump cleanout). Conversely, bioretention has background sediment (planting media) that obscure pollutant accumulation. Since pollutants tend to accumulate on the surface of media (typically within the first few inches), surface sediments should be targeted when sampling these systems. Coring these systems and compositing the core sediments will most likely result in further dilution of the PCBs retained in the media, making quantification more difficult. For all systems, larger pieces of litter and vegetation may be difficult to include in the analysis. A conservative approach is to exclude larger material and assume these have little association with PCBs.

4.3 Before-After Monitoring

Pollutant removal can also be estimated by monitoring discharge quality for treatment devices before and after installation. This may be attractive for green street projects that have multiple BMPs with multiple influent and effluent locations. Monitoring all of these individual systems is almost impossible because of space constraints. Note that since the data from before/after implementation are unpaired, variability is expected to be larger and the number of samples required to show significant removal much higher than for paired samples.

Before-after monitoring is also applicable to laboratory test systems in which water quality is measured before and after a change is made. For example, the rate of adsorption or the adsorptive capacity of media can be determined by measuring the water quality before and after addition of a known quantity of media.

5. Primary Data Objectives

The study design options discussed previously are matched to the primary management questions. The primary management questions require two data objectives: determine annual mass captured by HDS units and load removal by biochar-amended BSM. The primary management questions are:

1. What are the **annual PCB and mercury loads captured** by existing HDS units in Bay Area urban watersheds?
2. Are there readily available biochar-amended BSM that provide significantly better **PCB and mercury load reductions** than standard BSM and meet MRP infiltration rate requirements?

Monitoring to address the first management question should at minimum provide the average annual PCB and mercury loads captured by HDS units.

5.1 Data Objective 1: Annual Loads Captured by HDS Units

Determined by influent-effluent monitoring for individual storm events over one or more seasons or filter media/sediment sampling at end of each season.

Options:

- ❖ Influent-effluent monitoring. Requires monitoring of as many storms as possible over a season and flow measurement in addition to water quality sampling. Flow measurement is a critical component for estimating stormwater volumes treated, retained, and bypassed, and is often associated with additional measurements such as water depth within a BMP to estimate bypass and retention.
- ❖ Filter media/sediment sampling. Requires sampling at end of season but does not require influent/effluent water quality or flow measurement. Sediment sampling has a high value for estimating annual mass removal because a single composite sample of retained sediment over a season can yield an estimate of load removal for the constituents analyzed. However, influent characterization would also help explain mass removal performance. This method is most appropriate when applied to HDS systems because they can isolate retained sediment.

5.2 Data Objective 2: Loads Reduced by Biochar-Amended BSM

Determined by influent-effluent monitoring or filter media/sediment sampling for individual events until sufficient data are available for statistical analysis.

Options:

- ❖ Influent-effluent monitoring. Requires monitoring of multiple individual events and flow measurement in addition to water quality sampling. Accurate flow measurement in BMPs is difficult because flows can vary an order of magnitude during individual events and measurements may be required at multiple locations within a device because of bypass, infiltration etc. (see Figure 4.2). This complexity introduces a great degree of variability in the monitored data that can substantially increase the number of data points required to show statistically significant load removals, particularly for BMPs such as HDS units that

show relatively small differences between influent and effluent load reductions. This option is most appropriate for testing filter media, for example in laboratory experiments, in which accurate flow measurements are possible and sampling of accumulated sediment is infeasible.

- ❖ Filter media/sediment sampling. Requires sampling after individual events but does not require influent/effluent water quality or flow measurement. This method is not feasible for filter media because the retained sediment cannot be isolated from the filter media.

6. BMP Processes and Key Study Variables

The treatment mechanisms that occur in a BMP help inform selection and control of the study variables. These treatment mechanisms, also called *unit processes*, may include physical, chemical, or biological processes. The primary physical, chemical, and biological processes that are responsible for removing contaminants include the following:

- Sedimentation – The physical process by which suspended solids and other particulate matter are removed by gravity settling. Sedimentation is highly sensitive to many factors, including size of BMP, flow rate/regime, particle size, and particle concentration, and it does not remove dissolved contaminants. Treated water quality is less consistent compared to other mechanisms due to high dependence on flow regime, particle characteristics, and scour potential.
- Flocculation – Flocculation is a process by which colloidal size particles come out of suspension in the form of larger flocs either spontaneously or due to the addition of a flocculating agent. The process of sedimentation can physically remove flocculated particles.
- Filtration – The physical process by which suspended solids and other particulate matter are removed from water by passage through layers of porous media. Filtration provides physical screening of particles and trapping of particles within the porous media. Filtration depends on a number of factors, including hydraulic loading and head, media type and physical properties (composition, media depth, grain size, permeability), and water quality (proportion of dissolved contaminants, particle size, particle size distribution). Compared to sedimentation, filtration provides a more consistent treated quality over a wider range of contaminant concentrations.
- Infiltration – The physical process by which water percolates into underlying soils. Infiltration is similar to filtration except it results in overall volume reduction.
- Screening – The physical process by which suspended solids and other particulate matter are removed by means of a screen. Unlike filtration, screening is used to occlude and remove relatively larger particles and provide little or no removal for particles smaller than the screen opening size and for dissolved contaminants.
- Sorption – The processes of absorption and adsorption occur when water enters a permeable material and contaminants are brought into contact with the surfaces of substrate media, plant roots, and sediments, resulting in short-term retention or long-term immobilization of contaminants. The effectiveness of sorptive processes depends on many factors, including the properties of the water (contaminant concentration, particle concentration, organic matter, proportion of dissolved contaminants, particle size, pH, particle size and charge), media type (surface charge, absorptive capacity), and contact time.

- Chemical Precipitation – The conversion of contaminants in the influent stream, through contact with the substrate or root zone, to an insoluble solid form that settles out. Consistent performance often depends on controlling other parameters such as pH.
- Aerobic/Anaerobic Biodegradation – The metabolic processes of microorganisms, which play a significant role in removing organic compounds and nitrogen in filters.
- Phytoremediation – The uptake, accumulation, and transpiration of organic and inorganic contaminants, especially nutrients, by plants.

The relative importance of individual treatment mechanisms depend to a large extent on the chemical and physical properties of the contaminant(s) to be removed i.e. the influent quality. The two contaminants of interest in this study are PCBs and mercury. PCBs are relatively inert hydrophobic compounds that have very limited solubility and a strong affinity for organic matter. They are often associated with fine and medium-grained particles in stormwater runoff, making them subject to removal through gravitational settling or filtering through sand, soils, media or vegetation. Most of the mercury in water, soil, and sediments is in the form of inorganic mercury salts and organic forms of mercury such as methylmercury that are strongly adsorbed to organic matter (e.g., humic materials). In general, mercury is most strongly associated with fine particles while PCBs are generally associated with relatively larger and/or heavier particles. It is therefore expected that sedimentation, flocculation, and related processes will be less effective for mercury removal than for removal of PCBs (Yee and McKee, 2010).

The following subsections provide a brief description of the BMP types being evaluated in this study, the unit processes involved in each, and key variables that indicate possible data collection approaches. The final selection of the quantity and type of data to collect is presented in the “Optimized Study Design” section.

6.1 HDS Units

Hydrodynamic separators rely on sedimentation and screening as the primary removal mechanism for sediment and particulate pollutants. Treatment performance is highly dependent on the following:

- Influent quality (contaminant concentration, proportion of dissolved contaminants, particle size, particle size distribution, and particle density)
- BMP design and hydraulic loading/flow regime (size of unit versus catchment area)
- Operational factors (remaining sediment capacity)

HDS effluent quality is highly variable, particularly for contaminants such as mercury that are associated with fine particles that are not as effectively removed in HDS. These devices are expected to require a relatively large number of influent-effluent samples to demonstrate statistically significant reductions in pollutant concentrations. Therefore, analysis of retained sediment is an appropriate alternative to influent-effluent sampling for determining pollutant mass captured. Sediment can be analyzed when the device is cleaned.

6.2 Bioretention

Bioretention is a slow-rate filter bed system. It is planted with macrophytes (typically shrubs and smaller non-woody vegetation). The major sediment removal mechanism is physical filtration through the planting media. When retention time is sufficient, dissolved constituents can be removed by sorption to plant roots in the planting media, which typically contains clays and organics to enhance sorption. Treatment performance is highly dependent on the following variables:

- Influent quality (contaminant concentration, particle concentration, organic matter, proportion of dissolved contaminants, particle size, particle size distribution)
- BMP design and hydraulic loading rate/head (size of the unit in relation to catchment area and storm character)
- Media type and properties (composition, grain size, grain size distribution, adsorptive properties, and hydraulic conductivity)
- Volume reduction by infiltration
- Operational factors (surface clogging, short-circuiting)

The effluent quality from bioretention and enhanced bioretention is expected to be consistently higher than for sedimentation-type BMPs. These devices are expected to require a relatively fewer number of samples than HDS units to demonstrate statistically significant reduction because of better treatment of fine particles and dissolved contaminants.

It is important to note that laboratory and not field bioretention systems are of interest in this study. These laboratory systems, essentially cylindrical columns filled with the media being tested, attempt to simulate most, but not all, of the chemical, biological, and physical processes that occur in field devices. For example, volume reductions due to infiltration are not simulated in laboratory column experiments. The advantages of using media columns as proxies for field devices include improved control over operation, monitoring, and sample collection in ways that would be impractical in the field. This improved control makes it possible to test a large number of potential media and identify the most promising for future field testing.

7. Monitoring and Sampling Options

Key variables that affect water quality and sediment quality data are identified from knowledge of treatment processes. The following lists the process variables identified through knowledge of the treatment processes:

- Influent quality (contaminant concentration, particle concentration, organic matter, proportion of dissolved contaminants, particle size, particle size distribution, particle density)
- BMP design and hydraulic loading (flow rate, hydraulic head, flow regime)
- Media type and properties (composition, grain size, grain size distribution, adsorptive properties, and hydraulic conductivity)
- Operational factors (surface clogging, short-circuiting, remaining sediment capacity)

Some of the above variables can be controlled and others are measured to determine their effect on water quality and sediment quality. Inevitably, some variables will be beyond the control of the study but their expected impact should be considered based on theory, past experience, models, or observations from other studies.

7.1 HDS Units

7.1.1 Influent Quality

The location of the BMP can greatly affect influent water quality such as pollutant concentrations and particle characteristics because land use and land cover affect sediment mobilization and pollutant concentrations within the sediments. Land use is often used as an indicator of pollutant loading. The land uses of the areas of interest include industrial, commercial/mixed use, roads/rail, institutional, and residential. Because of past use of PCB and past PCB and mercury handling practices, age of the land use is also important, with generally higher concentrations from older industrial, commercial, and transportation areas, and lower concentrations from newer residential areas. However, PCB analysis by the San Francisco Estuary Institute (SFEI) showed that PCB concentration patterns were patchy within larger urban watersheds with higher concentrations. This finding indicates that mass reductions of PCBs may require site-specific sampling of influent loads or site-specific quantification of mass removed. Mercury data suggest areas with higher mercury concentrations are not as pronounced although generally where there is PCB contamination there is also high to moderate Hg contamination (Yee and McKee, 2010).

Since HDSs are primarily installed for trash capture, their distribution within the study area is assumed to be random. However, the primary interest is in watersheds with relatively high pollutant loads that are most likely to result in significant removal in HDSs (e.g., the Leo Avenue watershed). Land use or land use based pollutant yields can be used to represent average influent water quality when influent monitoring is not conducted.

Figure 7.1 shows the land use based PCB and mercury loadings for key designated land use types. It can be seen that unit PCB loading from watersheds with higher PCB concentrations and mercury loading from old industrial watersheds are substantially higher than the other land uses. Assuming particle size, particle size distribution, and other stormwater characteristics are similar for the different land uses, HDSs in higher concentration watersheds or old industrial watersheds are expected to capture much higher pollutant loads than those in other watersheds.

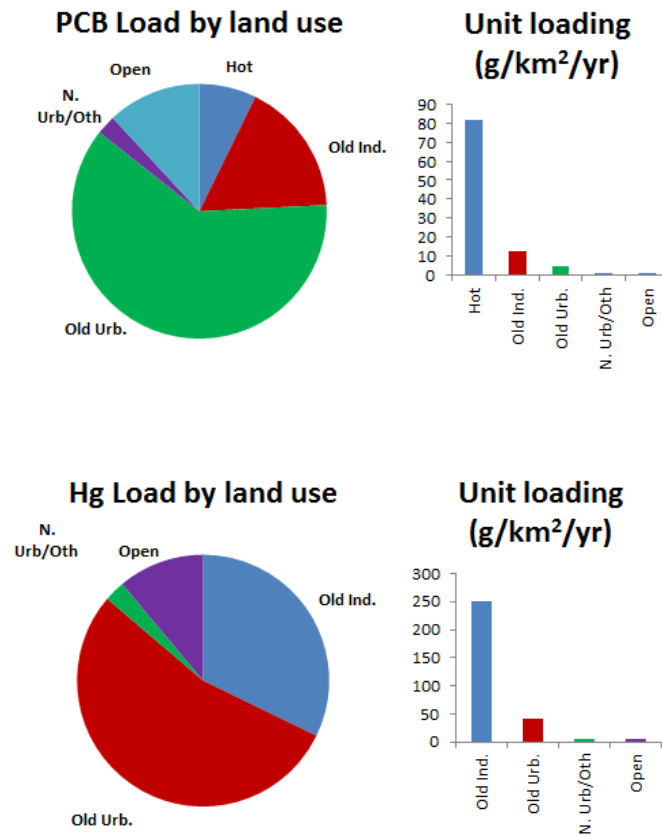

Figure 7.1 Land Use based PCB and Mercury Loading based on BASMAA Integrated Monitoring Reports (SFEI, 2015)

A preliminary land use based study design could categorize HDS sites as show in Table 7.1.

Table 7.1 HDS Sampling Design based on Watershed Land Use

Land Use	HDS Samples
Higher Concentration	X, X, X ¹
Old Industrial	X, X, X ¹
Old Urban	X, X, X ¹

1 – “X” represents a sample from a selected HDS unit in the specified land use category.

The above design is appropriate if HDS units can be categorized easily into one of the three land use categories. A review of the land uses within HDS watersheds indicates that most HDS units are in predominantly old urban watersheds, and it is unclear how many HDSs are within areas with higher PCB concentrations (Table 7.2).

Table 7.2 Percent of Land Use in HDS Watershed Areas

(Based on FY 2015-16 Co-permittee Annual Reports, Section 10 - Trash Load Reduction. Source: Chris Sommers Personal Communication)

HDS Catchment ID	New Urban	Old Industrial	Old Urban	Open Space	Other
287; Sonora Ave		16	84	1	
27A	15	50	34	2	
996; Parkmoor Ave		1	98	1	
1084; Oswego		0	89	0	10
600; Edwards Ave		33	39	28	
611; Balfour		14	55	30	
1082; Melody/33rd		0	97	3	
612; Lewis			93	7	
604; Sunset			96		4
1012; Blossom Hill/Shadowcrest			100	0	
1083; Lucretia		0	98	1	1
1002; Selma Olinder		10	86	5	
995; Dupont St.		9	91	0	
9-A; 73rd Ave and International Blvd		0	94	6	
475; 7th		68	29	3	
509; Coyote	22		77	1	
47			99	1	
8-A; Alameda Ave near Fruitvale		40	57	4	
575; Bulldog		6	93	1	
601; W. Virginia		7	90	3	
1504; Phelps			100	0	
390; Remillard		4	87	10	
Tennyson at Ward Creek		1	97	2	
W Meadow Dr		2	97	1	
Leland and Fair Oaks		1	99		
Ward and Edith			100	0	
5-D; 22nd and Valley		1	99	0	
8-C; High St @ Alameda Bridge		67	32	0	
5-G; Perkins & Bellvue (Nature Center)			100		
999; William		0	95	5	
Main St and Hwy 1			85	15	
Central Expy at Fair Oaks		11	89	0	
393; Wool Creek		18	78	4	
5-C; 27 St & Valdez Ave		2	98		
998; Pierce		1	96	3	
Maple and Ebensburg			98	2	
Ventura Ave			99	1	
Golden Gate and St Patrick			100	0	
5-A; Euclid Ave @ Grand Ave			100		
5-H; Lake Merritt (SD Outfall 11)			100		
5-B; Staten Ave & Bellvue			100		
Central Expy at De la Cruz		33	67		
5-I; Lake Merritt (SD Outfall 26)			100		
Mathilda overpass project CDS2		0	100		
Mathilda overpass project CDS1		10	84	7	

Given the few sites in categories other than old urban, an alternative study design based on mixed land uses may be more appropriate (Table 7.3).

Table 7.3 HDS Sampling Design based on Predominant Land Use

Predominant Land Use	HDS Samples
Higher Concentration/Old Industrial	X, X, X ¹
Old Urban/Old Industrial	X, X, X ¹
New Urban/Old Urban	X, X, X ¹

1 – “X” represents a sample from a selected HDS unit in the specified land use category.

The sampling design in Table 7.3 assumes that at least three HDS units are available for sampling in each PCB land use category. The sampling design may need to be modified further if there are an insufficient number of units available for sampling. For example, any site with more than 30% old industrial may be considered especially if it is a mixed zoned watershed (with industrial, commercial, residential and transportation land uses). The range of values in each land use category can be determined upon review of the most recent information. The design in Table 7.3 assumes that the characteristics of the runoff (e.g., particle sizes) are similar for the different land uses and only the yield is different.

Only sediment sampling is proposed for HDS. Since HDS influent-effluent monitoring is not required, variables such as proportion of dissolved contaminants, particle size, particle size distribution, and particle density are not measured or controlled, but their effect on influent quality and treatment is accounted for by randomly selecting HDSs within each land use category.

7.1.2 BMP Design and Hydraulic Loading

BMP design and hydraulic loading, which depends on the size of the BMP, can have a substantial impact on effluent water quality and the quantity of sediment retained in a BMP. Consequently, a full range of BMP designs and sizes are of interest. Properly sized, BMPs infrequently exceed their design capacity. However, BMPs are not always sized to standard specification, especially in retrofit environments in which typical hydraulic loading is much higher due to space constraints.

HDS units are typically proprietary and designs and sizing vary widely. Sediment capture may vary because of design differences such as number of chambers and design of overflow weirs and baffles, as well as different sizing criteria that can greatly affect both hydraulic loading and flow regime. The purpose of the study is to characterize sediment in HDS units in the study area. Since BMP design and sizing are important factors affecting HDS performance, it is necessary to include a range of HDS units in the study design and not just randomly select HDS units. A randomized blocked study design is therefore considered more appropriate than a completely random one that may result in an insufficient number of HDS units of a certain size.

In a randomized design, one factor or variable is of primary interest (e.g., land use), but there are one or more other confounding variables that may affect the measured result but are not of primary interest (e.g., HDS design, HDS size). Blocking is used to remove the effects of one or more of the most important confounding variables and randomization within blocks is then used to reduce the effects of the remaining confounding variables. An appropriate sampling design could therefore be land use as the primary factor and HDS size as the blocking factor. Since the population of HDS units in the land use categories of interest is limited, only

two size blocks are used ($\leq 50^{\text{th}}$ percentile, $> 50^{\text{th}}$ percentile), and other variables such as design differences are accounted for by random selection within each block (Table 7.4).

Table 7.4 HDS Sampling Design based on Predominant Land Use and HDS Size

Predominant Land Use	HDS Size	
	$\leq 50^{\text{th}}$ percentile	$> 50^{\text{th}}$ percentile
Higher Concentration/Old Industrial	X, X, X ¹	X, X, X ¹
Old Urban/Old Industrial	X, X, X ¹	X, X, X ¹
New Urban/Old Urban	X, X, X ¹	X, X, X ¹

1 – “X” represents a sample from a selected HDS unit in the specified land use category.

For the sampling design in Table 7.4, an HDS size factor is required to differentiate the two types of sizes that are of interest. In controlled field study of 4 different proprietary HDS units and laboratory testing of 2 other units, Wilson et al. (2009) developed a *performance function* (treatment factor) that reasonably predicted the removal efficiency of a given hydrodynamic separator. The performance function explained particle removal efficiency in terms of a Péclet number, P_e , which accounts for particle settling and turbulent diffusion. In the following equation, V_s is the particle settling velocity, h is the settling depth in the device, d is the device diameter, and Q is the flow through the device:

$$P_e = \frac{V_s h d}{Q}$$

The above Péclet number (Wilson et al’s performance function) can be used in the sampling design as the HDS size factor. For grouping the available HDS units into the two blocks, information is required on the particle diameter and design parameters for each device (settling depth, diameter, and design flow). Particle diameter can be assumed to be 75 μm , which is the critical size used for partitioning PCB fractions in Yee and McKee (2010), and is also approximately the size separating silt and fine sand size particles. The design flow can be calculated from knowledge of the drainage area to the device and a standard design storm. Note that the design flow should not be based on manufacturer guidance because different manufacturers use different sizing criteria and device sizing may not always follow manufacturer guidance.

The final sampling design may need revision depending on the monitoring approach, availability of HDSs, information on watershed land use and sizing, and the level of participation from municipalities.

7.1.3 Operation and Maintenance

Maintenance frequency can greatly impact BMP performance. For sedimentation BMPs such as HDS, sediment levels may exceed the sediment capacity of the BMP, decreasing the volume for sedimentation and increasing scour.

Operation and maintenance (e.g., cleanout frequency) are not of direct interest in this study and their effect on treatment is not being tested. However, these are confounding variables that need to be excluded. In the HDS sediment sampling design, HDS units that are considered at capacity or will reach capacity during the study should be excluded from the population of interest. Field observations are required to make this determination (e.g., whether the screen is blocked). These units can be cleaned out and sampled in a subsequent year. For each selected HDS unit, maintenance schedules (past and current) will need to be reviewed to determine the time period over which sediment accumulated.

7.2 Enhanced Bioretention

7.2.1 Influent Quality

The purpose of the laboratory testing is to screen alternative biochar-amended BSM and identify the most promising for further field testing. The laboratory testing requires influent-effluent monitoring. Influent water characteristics can vary depending on the source of the test water. PCB and mercury loading is largely a result of historic activities that result in accumulation in sediments of pervious areas. Mobilization of these sediments may require exceeding site-specific intensity and volume thresholds. Storm intensity is critical to detach and mobilize particles and storm volume must exceed any depression storage within the pervious areas. However, the precise effect of storm intensity and volume on the mobilization of PCB-contaminated and mercury-contaminated sediments has not been established. Influent water characteristics also depend greatly on drainage area characteristics including traffic and industrial and commercial activity.

Since the purpose of the laboratory study is to screen alternative biochar-amended BSM that can be used throughout the Bay Area, collection and use of stormwater from one or more representative watersheds is preferred. A preliminary review of available Bay Area stormwater runoff monitoring data from 27 sites (Table 7 of SFEI 2015) suggests median PCB concentration is about 9 ng/L. Therefore, one or more previously monitored watersheds with mean PCB concentrations well above 10 ng/L may be appropriate for collection of stormwater for the laboratory testing. Since the relative treatment performance of the various media at even lower concentrations may be different, additional tests with diluted stormwater may be required to confirm study results.

Storms from the representative watershed should be targeted randomly without bias, thereby accounting for the effects of storm intensity and ensuring variability in contaminant concentration, proportion of dissolved contaminants, particle size, particle size distribution, and particle density. To achieve this, minimal mobilization criteria should be used to ensure predicted storm intensity and runoff volume are likely to yield the desired volume.

7.2.2 BMP Design and Hydraulic Loading

The design variables in the enhanced bioretention testing laboratory study include media type, media depth, and media configuration. Media type is a key variable that is discussed further below. Testing the effect of different media depths or media configurations is not a research objective of the laboratory study, so these can be fixed for all experiments. Typical bioretention media depth in the Bay Area is 18 inches, so all column experiments should use 18 inches of BSM. In the Richmond PG&E Substation 1st and Cutting enhanced BSM testing, the biochar was not installed as a separate layer but was instead mixed with the standard BSM. It is unclear how treatment is affected by these two media configurations, but for consistency with previous field work the biochar and standard BSM should be mixed.

Hydraulic loading is a controlled variable that can be kept constant for all columns. Since the laboratory study is attempting to replicate field bioretention, the hydraulic loading can be the design loading for bioretention. Bioretention designs in the Bay Area typically have a maximum ponding depth of 6 inches, so a loading of 6 inches could be used for the column tests. There are two options for loading the columns: pump and manual. Peristaltic pumps are ideal for controlled loading, but in this study manual loading (batch loading) is more appropriate because of the potential for PCBs and mercury to stick to tubing, pump parts, etc. For manual loading, up to 10 inches of stormwater may be needed each time to ensure sufficient sample volume.

7.2.3 Media Type and Properties

Media type and properties have a substantial effect on the treatment performance of filtration devices. This group of variables include composition, grain size, grain size distribution, adsorptive properties such as surface area, and hydraulic conductivity. Media composition is a primary variable that accounts for differences in the biochars used and the proportion of each biochar in the amended BSM mix. The other variables (grain size, grain size distribution, adsorptive properties, and hydraulic conductivity) are not of direct interest in this study and are assumed to vary randomly or are controlled through screening experiments that limit their variability.

Biochar is produced from nearly any biomass feedstock, such as crop residues (both field residues and processing residues such as nut shells, fruit pits, and bagasse); yard, food, and forestry wastes; animal manures, and solid waste. Biochar feedstock and production conditions can vary widely and significantly affect biochar properties and performance in different applications, making it difficult to compare performance results from one study to another (BASMAA, 2017a). A laboratory study that characterized the physical properties of six different waste wood derived biochars found particle sizes ranging from over 20mm to fine powder and surface areas ranging from 0.095 to 155.1 m²/g (Yargicoglu et al., 2015). The variability in biochar types and properties is expected to result in large variation in treatment efficiency and infiltration rates. Given the large number of potential biochars that could be tested and the need to meet an initial maximum 12 in/h infiltration rate and a minimum long-term infiltration rate of 5 in/h, a phased study design is appropriate. In such a phased study, promising readily available biochars are first identified through a review of the literature, and hydraulic screening experiments are performed on biochar-BSM media mixes to ensure infiltration rates are met

prior to performance testing. This approach is expected to be the most cost-effective because it reduces analytical costs.

There is little information on hydraulic properties of bioretention media amended with biochar, and it is not clear what percentage of the amended BSM should be biochar to maximize treatment benefit. Given the variable physical size of the biochar media, relatively fine biochars could result in a mix that does not meet the initial 12 in/h maximum infiltration rate or minimum 5 in/h long-term infiltration rate. Kitsap County (2015) tested a BSM mix containing 60% sand, 15% Compost, 15% Biochar, and 10% shredded bark, and found that the biochar mix had an infiltration rate of only 6.0 in/h. One conclusion of the study was that the reduction in infiltration rate with the biochar additive was most likely because of fines in the biochar. To overcome this, hydraulic screening experiments are required in which the infiltration rate for each media mix is measured prior to water quality testing to ensure that both the maximum and minimum rates are met. Initially, each biochar can be mixed with standard BSM at a rate of 25% biochar by volume (the same as that at the CW4CB Richmond PG&E Substation 1st and Cutting site). Hydraulic conductivity can be determined using the method stated in the BASMAA soil specification, method ASTM D2434, which requires measurement of water levels and drain times. If a mix does not meet the infiltration requirements, the percentage of biochar is adjusted and the new mix tested. Amended mixes that do not meet the infiltration rate requirements are removed from further consideration (i.e. the effect of hydraulic conductivity is controlled by screening).

The final phase of the laboratory study can be column testing to identify the most effective amended BSM mixes for field testing. An influent-effluent monitoring design is typically used in column testing and media effectiveness is assessed on a storm-to-storm basis with real stormwater collected in the Bay Area. Only media mixes that have passed the hydraulic screening should be tested. All media columns should be sufficiently large or replicated to account for or minimize the impact of variability in media installation and experimental technique. Standard BSM should be used as a control since the primary interest is to identify media mixes that perform significantly better than standard BSM. An example of the column sampling design for 5 new media mixes and one standard BSM control is shown in Table 7.5. The key variable of interest in the sampling design in Table 7.5 is the media mix (composition).

Table 7.5 Example Sampling Design for Laboratory Column Experiments

Biochar/BSM Mix	Column Samples
A Mix	X, X, X ¹
B Mix	X, X, X ¹
C Mix	X, X, X ¹
D Mix	X, X, X ¹
E Mix	X, X, X ¹
Control Mix	X, X, X ¹

1 – “X” represents an influent or effluent sample.

7.2.4 Operation and Maintenance Parameters

Operational life depends on the capacity to pass the minimum required stormwater flows. Like media life, operational life is important because it determines the frequency and cost of maintenance requirements. Maintenance frequency can greatly impact BMP performance, and lack of maintenance can lead to surface clogging and sediment clogging in the inlets which reduces treatment capacity and increases bypass and overflow. Operation and maintenance are not of direct interest in this study and their effect on treatment is not being tested. However, these are confounding variables that need to be excluded.

Media mixes that do not meet the maximum 12 in/h and minimum 5 in/h infiltration rates can be excluded by hydraulic screening experiments (discussed above). As well as meeting the maximum 12 in/h initial infiltration rate requirement, these screening experiments help ensure that the BSM mixes do not fail during the laboratory testing. However, operational performance in laboratory experiments is not expected to be representative of that in the field because of differences in influent quality, variability in loading, effects of vegetation, etc. Therefore, laboratory estimates of long term infiltration rate are of little use and field testing is required to confirm that selected media mixes meet the long-term minimum infiltration rate of 5 in/h. The laboratory testing, however, can provide relative comparisons of hydraulic performance that can be used to decide and screen out media mixes that are likely to hydraulically fail in the field.

7.3 Uncontrolled Variables and Study Assumptions

The following assumptions were adapted from the Caltrans PSGM (Caltrans, 2009):

- ❖ Site Assumptions
 - HDS sediment concentrations are representative of the land use within the watershed, i.e. there are no sources of sediment from adjoining watersheds, from illicit discharges, or from construction activities
 - HDS sediment or influent is not affected by base flow, groundwater, or saltwater intrusion
 - Differences in storm patterns throughout the Bay Area are not sufficient to change the HDS performance measurements
 - Water quality of stormwater collected for laboratory testing is representative of that observed in Bay Area urban watersheds
- ❖ BMP Operation Assumptions
 - Sampled HDS units operated as designed (e.g., no significant scouring)
 - Volatilization of pollutants is negligible
 - There is no short-circuiting of flows in laboratory column studies
- ❖ Media Selection Assumptions
 - The readily available biochars selected are representative of all biochars
 - Selected media do not leach contaminants and media conditioning (e.g., washing) is not required
- ❖ Monitoring Assumptions

- Data collected from a few sites over a relatively short time span will accurately represent sediment at all HDS sites over longer time frames
- There are minimal contaminant losses in collecting and transporting water for laboratory experiments
- Water quality of stormwater for laboratory tests does not change significantly during each test
- Stormwater loading of laboratory columns is representative of loading in the field
- Long-term infiltration performance of biochar mixes is to be tested in the field

8. Final Study Design

The study design is optimized to answer the primary management questions within the available budget. The design used prioritizes sampling of HDS units, but allocates sufficient funding for minimum sampling requirements for the laboratory media testing study. Monitoring that does not relate directly to the primary management questions is considered lower priority.

8.1 Statistical Testing & Sample Size

In a traditional test of a treatment, the null hypothesis is that there is no difference between the influent and effluent of a treatment (i.e., the treatment does not work). In the case of HDS sampling, influent-effluent sampling is not required, and interest is only in determining if HDS units remove PCBs and mercury and how the sediment concentrations and load removals vary for different land uses, and for different rainfall and stormwater flow characteristics. Statistical testing in the HDS study is therefore limited to testing if there is a difference in the concentrations and loads captured by HDS units in different watersheds. This testing will require sampling of a sufficient number of HDS units in each land use category associated with differing pollutant load yields.

In the laboratory study, influent-effluent sampling is required and traditional statistical tests can be used depending on sample size.

As well as traditional statistical testing, confidence in the conclusions can be established by comparing total PCB and mercury performance to that for other constituents that directly affect it (e.g., suspended solids, total organic carbon) or have similar chemistry (e.g., other organics). As stated previously, total PCB and mercury concentrations are expected to correlate to some extent with particulates and organics. Comparisons to other constituents are particularly useful for studies in which treatment is expected to be low and the corresponding sample size requirements very high.

Sample size requirements are smaller for paired sampling designs (i.e., influent and effluent sampling for the same storm event) than for independent sampling designs. Paired sampling is not possible for the HDS sampling study that has no influent-effluent monitoring, but is possible in the laboratory media testing study. Additionally, the number of samples required to show significant treatment are generally fewer for filtration-type BMPs than sedimentation-type BMPs because of their better and more consistent treatment.

8.2 Constituents for Sediment Analysis

Constituents selected for HDS sediment analysis must meet the data objectives discussed previously in “Primary Data Objectives”, and be consistent with Table 8.3 of the MRP (SFRWQCB, 2015). Sediment samples will be screened using a 2 mm screen prior to analysis. Table 8.1 lists the constituents for sediment quality analysis. Total organic carbon (TOC) is included because it is a MRP requirement and can be useful for normalizing PCBs data collected for the sediment.

The primary objective of sediment analysis is quantification of the mass of PCBs and mercury accumulating within HDS units. Consequently, PCBs and total mercury are analyzed

for all screened sediment samples. The secondary objective is to establish a relationship between total PCBs, mercury, and particle size. Correlating total PCBs and mercury to particle sizes will complement past studies and provide insight into the type of BMPs that are appropriate to achieve the most cost-effective mass removal.

Analysis of PCBs at the CW4CB Leo Avenue HDS showed that PCBs in the water above the sediment may be minor when compared to sediment-associated PCBs (BASMAA, 2017b). PCB concentrations in overlying water are expected to be low and sampling of this water is not included in this study design.

Table 8.1 Selected Constituents for HDS Sediment Monitoring

Constituent
TOC
Total Mercury ¹
PCBs (40 congeners) in Sediment
Particle Size Distribution
Bulk Density

¹ - Only total mercury analyzed. Methyl mercury is not relevant for SF Bay TMDL.

8.3 Constituents for Water Quality Analysis

Constituents for analysis of water samples must meet the data objectives discussed previously in “Primary Data Objectives”, and be consistent with Table 8.3 of the MRP (SFRWQCB, 2015). Table 8.2 lists the constituents for the laboratory media testing studies. The list of water quality constituents must provide data to address the primary management question to quantify total PCB and mercury reduction, so PCBs and total mercury are analyzed for all samples. Secondary management questions relate to understanding removal performance for total PCB and mercury.

In addition to PCBs and total mercury, the other constituents selected for influent and effluent analysis are SSC, turbidity, and TOC. SSC was selected because it more accurately characterizes larger size fractions within the water column, while turbidity was selected because it is an inexpensive and quick test to describe treatment efficiency where strong correlation to other pollutants has been established. As with the sediment analysis, TOC is included because it is a MRP requirement and can be useful for normalizing PCBs data collected for water samples.

Table 8.2 Selected Aqueous Constituents for Media Testing in Laboratory Columns

Constituent
SSC
Turbidity
TOC
Total Mercury ¹
PCBs (40 congeners) in Water

1 - Only total mercury analyzed. Methyl mercury is not relevant for SF Bay TMDL.

8.4 Budget and Schedule

The monitoring budget for the study is approximately \$200,000. A contingency of 10 percent of the water quality monitoring budget is recommended to account for unforeseen costs such as equipment failure. Another constraint is that all sampling will occur in one wet season.

8.5 Optimized Study Design

The optimized study designs are presented in Tables 8.3 and 8.4 for the HDS Monitoring and Enhanced Bioretention studies, respectively. Several iterations were analyzed and the study designs shown are based on best professional judgment to allocate the budget to the various data collection options.

The final design for the HDS monitoring study is based on selection and sampling of 9 HDS units in key land use areas. The number of units that can be sampled is limited because sampling is expected to be opportunistic as part of regular maintenance programs. Therefore, a simple design with 9 units is appropriate. The data analysis will evaluate the percent removal achieved for each HDS unit during the time period of interest (i.e., the time period between the date of the previous cleanout, and the current cleanout date for each HDS unit sampled) by incorporating modeled estimates of stormwater volumes and associated pollutant loads for each HDS unit catchment. Because HDS units are sized to treat stormwater runoff from storms of a given size and intensity, excess flows for storms exceeding the design capacity will bypass the unit and are not treated. Storm by storm analysis of rainfall data during the time period of interest will allow estimation of the total stormwater volume and pollutant load to the catchment during each storm, as well as the volume and pollutant load that bypassed the HDS unit and was not treated. This information will then be combined with the measured pollutant mass captured by each HDS unit to quantify the percent removal of PCBs and mercury from the total catchment flow, and the percent removal of PCBs and mercury from the treated flow. For each HDS unit sampled in the study, the total and treated pollutant mass removed will be calculated using the following equations.

$$(1) \text{ Total Pollutant Mass Removed (\%)} = \left[\frac{M_{\text{HDS-i}}}{M_{\text{Catchment-i}}} \right] \times 100\%$$

$$(2) \text{ Treated Pollutant Mass Removed (\%)} = \left[\frac{M_{\text{HDS-i}}}{(M_{\text{Catchment-i}} - M_B)} \right] \times 100\%$$

Where:

- $M_{\text{HDS-i}}$ the total POC mass captured in the sump of HDS Unit i over the time period of interest
- $M_{\text{Catchment-i}}$ the total POC mass discharged from Catchment-A (the catchment draining to HDS unit A) over the time period of interest
- M_{B} the total POC mass that bypassed HDS unit A over the time period of interest

The following inputs will be measured or modeled for the time period of interest for use in the equations above:

- Total PCBs and mercury mass captured by a given HDS unit. This is the mass measured in each HDS unit during this project.
- The total stormwater volume and associated PCBs and mercury load from the HDS unit catchment. This will be modeled on a storm by storm basis using available rainfall data, catchment runoff coefficients, and assumed pollutant stormwater concentrations.
- The stormwater volume and associated PCBs and mercury load that bypassed the HDS unit. The bypass volume (and associated pollutant load) during each storm (if any) will be calculated based on the design criteria for a given HDS unit.
- The total PCBs and mercury load treated by a given HDS unit. This will be determined by subtracting the bypass load (if any) from the total pollutant load for the catchment.

The corresponding design for the enhanced BSM study is based on testing of readily available biochars in hydraulic screening experiments followed by column testing of up to five promising BSM mixes as well as a standard BSM control mix. The final number of BSM mixes will depend on availability and media properties (e.g., expected hydraulic conductivity). The optimized designs will yield 33 data points for the key data objectives, 9 from the HDS monitoring study and 24 from the enhanced BSM media testing column study.

Table 8.3 HDS Monitoring Study Design

Primary Management Question(s)	What are the annual PCB and mercury loads captured by existing HDS units in Bay Area urban watersheds and the associated percent removal?												
Type of Study	Sediment monitoring; modeling stormwater volume and pollutant load												
Data Objective(s)	Annual PCB and mercury mass captured in HDS units and percent removal												
Description of Key Treatment Processes	Sedimentation, Flocculation & Screening <ul style="list-style-type: none"> Removal by gravity settling and physical screening of particulates Effectiveness depends on water quality, BMP design and hydraulic loading/flow regime, and operational factors 												
Key Variables	<ul style="list-style-type: none"> Sediment quality and quantity Influent quantity and quality (contaminant concentration,) BMP design and hydraulic loading/flow regime BMP maintenance (remaining sediment capacity) 												
Monitoring Needs	<p>Monitored variables: sediment quality, sediment mass</p> <p>Controlled variables: influent quality, BMP maintenance (remaining sediment capacity)</p> <p>Uncontrolled variables: HDS design, hydraulic loading, flow regime</p>												
Monitoring Approach	<p>Influent quantity and quality: based on rainfall/runoff characteristics and on land use pollutant yield (old urban, new urban, etc.)</p> <p>Hydraulic loading: base on HDS size (diameter and settling depth) and flow (design flow for known watershed size)</p> <p>BMP maintenance: base on remaining sump capacity</p>												
Sampling Design	<p>Sampling expected to be opportunistic as part of regular maintenance programs. Targeted predominant land uses for HDS selection and corresponding data generation:</p> <table border="1" data-bbox="529 1066 1357 1230"> <thead> <tr> <th>Predominant Land Use</th> <th>HDS Samples</th> <th>No. Samples (Total 9)</th> </tr> </thead> <tbody> <tr> <td>Higher Concentration/Old Industrial</td> <td>X, X, X¹</td> <td>3</td> </tr> <tr> <td>Old Urban/Old Industrial</td> <td>X, X, X¹</td> <td>3</td> </tr> <tr> <td>New Urban/Old Urban</td> <td>X, X, X¹</td> <td>3</td> </tr> </tbody> </table> <p>1 – “X” represents a sample from a selected HDS unit. Yield categories will be determined during site selection.</p> <ul style="list-style-type: none"> Exclude units at full sump capacity (cleanout and monitor subsequent year if possible) 	Predominant Land Use	HDS Samples	No. Samples (Total 9)	Higher Concentration/Old Industrial	X, X, X ¹	3	Old Urban/Old Industrial	X, X, X ¹	3	New Urban/Old Urban	X, X, X ¹	3
Predominant Land Use	HDS Samples	No. Samples (Total 9)											
Higher Concentration/Old Industrial	X, X, X ¹	3											
Old Urban/Old Industrial	X, X, X ¹	3											
New Urban/Old Urban	X, X, X ¹	3											
Constituent List	TOC, total mercury, PCBs (40 congeners) in sediment, particle size distribution, and bulk density												
Data Analysis	Independent (unpaired) samples. Present range of total PCB and mercury concentrations measured and mass removed/area treated. Analyze using ANOVA. Model estimates of catchment stormwater volumes and PCB and mercury stormwater loads combined with the measured mass captured in the unit to calculate the percent removal.												

Table 8.4 Enhanced BSM Testing Study Design

Primary Management Question(s)	Are there readily available biochar-amended BSM that provide significantly better PCB and mercury load reductions than standard BSM and meet MRP infiltration rate requirements?																								
Type of Study	Influent-effluent monitoring																								
Data Objective(s)	PCB and mercury load removal																								
Description of Key Treatment Processes	<p>Filtration and Adsorption</p> <ul style="list-style-type: none"> Removal by physical screening, trapping in media, and retention on media surface Effectiveness depends on influent water quality, BMP design and hydraulic loading/flow regime, media type and properties, and operational factors 																								
Key Variables	<ul style="list-style-type: none"> Influent and effluent quality (PCB concentration, particle concentration, organic matter, proportion of dissolved contaminants, particle size, particle size distribution) BMP design (media depth) and hydraulic loading/head Media type and properties (composition, grain size/size distribution, adsorptive properties, hydraulic conductivity) BMP maintenance (surface clogging, short-circuiting) 																								
Monitoring Needs	<p>Monitored variables: Influent and effluent quality contaminant concentration, particle concentration, organic matter, surface clogging</p> <p>Controlled variables: media depth, hydraulic loading/head, media composition and adsorptive properties, hydraulic conductivity</p> <p>Uncontrolled variables: Influent and effluent proportion of dissolved contaminants, particle size, particle size distribution, short-circuiting</p>																								
Monitoring Approach	<p>Phased approach because of number of media/need to ensure MRP infiltration rates</p> <ol style="list-style-type: none"> Hydraulic tests to ensure amended media meet infiltration requirements Influent-effluent column tests for select mixes with Bay Area stormwater Influent-effluent column tests for best mix with Bay Area stormwater at lower concentrations 																								
Sampling Design	<p>Phase I Hydraulic Tests:</p> <ul style="list-style-type: none"> Determine infiltration rates for media mixes with 25% biochar by volume If MRP infiltration rates not met, adjust biochar proportion and retest Target infiltration rate of 5 - 12 in/h for all mixes, attempt to control rate to +/- 1 in/hr. <p>Phase II Influent-Effluent Column Tests with Bay Area Stormwater (up to 5 mixes)</p> <table border="1" style="margin-left: auto; margin-right: auto;"> <thead> <tr> <th>Biochar/BSM Mix</th> <th>Column Samples</th> <th>No. Samples (Total 21)</th> </tr> </thead> <tbody> <tr> <td>A Mix</td> <td>X, X, X</td> <td>3</td> </tr> <tr> <td>B Mix</td> <td>X, X, X</td> <td>3</td> </tr> <tr> <td>C Mix</td> <td>X, X, X</td> <td>3</td> </tr> <tr> <td>D Mix</td> <td>X, X, X</td> <td>3</td> </tr> <tr> <td>E Mix</td> <td>X, X, X</td> <td>3</td> </tr> <tr> <td>Control Mix</td> <td>X, X, X</td> <td>3</td> </tr> <tr> <td>Influent</td> <td>X, X, X</td> <td>3</td> </tr> </tbody> </table> <p>Phase III Influent-Effluent Column Tests for Select Mix with Diluted Bay Area Stormwater</p> <ul style="list-style-type: none"> Perform tests with diluted stormwater, if necessary, to confirm effectiveness at concentrations representative of New Urban and New Industrial land Test at one dilution (1 influent and 1 mix and 1 control effluent) (3 samples) 	Biochar/BSM Mix	Column Samples	No. Samples (Total 21)	A Mix	X, X, X	3	B Mix	X, X, X	3	C Mix	X, X, X	3	D Mix	X, X, X	3	E Mix	X, X, X	3	Control Mix	X, X, X	3	Influent	X, X, X	3
Biochar/BSM Mix	Column Samples	No. Samples (Total 21)																							
A Mix	X, X, X	3																							
B Mix	X, X, X	3																							
C Mix	X, X, X	3																							
D Mix	X, X, X	3																							
E Mix	X, X, X	3																							
Control Mix	X, X, X	3																							
Influent	X, X, X	3																							
Constituent List	SSC, turbidity, TOC, total mercury, PCBs (40 congeners) in water																								
Data Analysis	Dependent (paired) samples. Present range of total PCB and mercury concentrations measured and mass removal efficiencies. Analyze using ANOVA and regressions of influent/effluent quality. Perform sign-rank test to compare consistency in relative performance among the columns.																								

8.6 Adequacy of Study Design

The primary management questions are reviewed in this section in light of the budgeted data collection efforts. The primary management questions are restated and followed by an analysis of the adequacy of the data collection effort.

1. *What are the annual PCB and mercury loads captured by existing HDS units in Bay Area urban watersheds?*

Table 8.3 lists the number of data points that are anticipated for the HDS monitoring study.

This selected design will provide 9 data points for each of the following: PCB sediment concentration, mercury sediment concentration, and sediment mass. This design will not be able to assess the effect of HDS size and hydraulic loading on pollutant removal, and may not be able to statistically differentiate load capture between different land uses because of the small sample count for each land use (3). However, this design is selected because of the lack of information available on HDS sizing and the opportunistic nature of the sampling which limits the number of HDS units that can be sampled. The effect of maintenance is eliminated by ensuring that samples are not collected from units that have no remaining sump capacity.

The HDS study design collects independent (unpaired) samples since each HDS unit is sampled independently and there is no relationship between the various HDS units. This limits ability to discern differences due to land use or HDS size, especially when sample size is relatively low and there is considerable variability in the data collected. Although the study design yields 9 data points for each data objective, it may not be sufficient to draw statistically-based conclusions. However, the study will provide point estimates of loads removed during cleanouts and how they vary for different land uses (e.g., X g of PCBs are removed per unit area of Y land use). This is the metric used for effectiveness of HDS cleanouts, so the study will provide a practical improvement in knowledge that can be applied to future HDS effectiveness estimates.

In addition, modeled stormwater flows and associated POC loads to each HDS unit catchment during the time period between cleanouts will be developed. These modeled estimates will be used along with the measured mass captured in the HDS unit between cleanouts to quantify the percent removal for each unit during the study.

2. *Are there readily available biochar-amended BSM that provide significantly better PCB and mercury load reductions than standard BSM and meet MRP infiltration rate requirements?*

Table 8.4 lists the number of data points that are anticipated for the enhanced BSM testing study. The sampling design will yield 19 data points for each of the following: effluent PCB concentration, effluent mercury concentration. Including influent analysis, a total of 24 samples will be analyzed. The purpose of this study is to identify the best biochar amended BSM mixes for field testing and not test the effect of confounding variables such as influent quality and hydraulic loading on load removals. The study design accounts for these confounding variables by either ensuring their effect is randomized (e.g., influent water quality) or keeps them fixed (e.g., hydraulic loading). To ensure influent stormwater concentrations are representative of typical Bay Area concentrations, an additional column test with diluted

stormwater is performed on an effective media mix. Standard BSM controls are used for each column run so that removal by biochar amended mixes can be compared directly to removal by standard BSM. Infiltration experiments are performed prior to the column testing to ensure media selected for final column testing will meet the MRP infiltration rate requirements.

The enhanced BSM column study design collects dependent (paired) samples since each effluent sample is related to a corresponding influent sample. Additionally, standard BSM controls are used for each run which makes it possible to directly compare effluent quality for each amended BSM to standard BSM. The paired sampling design, use of standard BSM controls, and ability to control or fix many of the variables that effect load removal increase the ability to discern differences in treatment. Therefore, only 3 column runs are proposed, and available budget is instead used in initial hydraulic screening experiments to ensure selected media mixes meet MRP infiltration rate requirements. The study design may not be sufficient to draw statistically-based conclusions because it yields only 3 data points for each biochar mix tested. However, the study will enable direct comparisons of effluent quality and treatment between mixes for individual events and consistency of treatment between events. The information provided by the study is expected to be sufficient to identify the most promising biochar mixes for field testing.

The study designs for the HDS monitoring and enhanced bioretention studies meet MRP sample collection requirements. The sampling design for the HDS monitoring study will yield a minimum of 9 PCB and mercury data points, while the sampling design for the enhanced bioretention laboratory study will yield 24 PCB and mercury data points (including influent analysis). The minimum number of PCB samples for this study plan is 33 (9+24). Because 3 of the 32 BMP effectiveness samples required by the current MRP have already been collected, the minimum number required for this project is 29. This study must yield 29 of the 32 permit-required samples, per Provision C.8.f of the MRP. To ensure that at least 29 samples are collected to meet the MRP requirement, additional samples will be collected during the laboratory media testing runs if fewer than 5 HDS units are available for sampling.

9. Recommendations for Sampling and Analysis Plans

This section presents specific recommendations for the development of SAPs. More detailed information is available in Section 6 of the Caltrans Monitoring Guidance Manual (Caltrans, 2015) and in the Urban Stormwater BMP Performance Monitoring (WERF 2009). Analysis of constituents should follow the CW4CB Quality Assurance Project Plan (BASMAA 2013).

9.1 HDS Monitoring

The following SAP recommendations are based on the lessons learned from sampling the Leo Avenue HDS site (BASMAA, 2017b):

- Include equipment to determine sump capacity before sampling. The study design does not require sampling of units that are full (i.e., have no remaining sump capacity). The depth of the unit can make it difficult to inspect for sump basin contents, and use of a “sludge judge” or other similar equipment may not be possible because of difficulty penetrating through compacted organic materials.
- The sampling is expected to be opportunistic sampling during regular cleanouts. Since it coincides with regular maintenance patterns, the occurrence of a clean and empty vactor truck from which samples of the sediment can be taken is unlikely. To obtain representative samples, multiple grab samples that extend from the top of the sediment layer to the bottom of the sump will need to be collected and composited prior to analyses.
- Sediment samples will require screening to remove coarse particles, trash, etc. In the CW4CB study (BASMAA, 2007b), only sediment less than 2 mm in size was analyzed.

It is unclear how samples of the HDS sediment were taken in the Leo Avenue HDS sampling. Appropriate sampling methods should be developed to ensure the samples collected are representative of the sediment in the HDS units.

HDS sediment sampling is not expected to require additional handling/safety precautions beyond normal drain cleaning safety procedures. Human health criteria for PCBs are for exposure via ingestion or vapor intake and not for contact. OSHA directive STD 01-04-002 state that “repeated skin contact hazards with all PCB's could be addressed by the standards 1910.132 and 1910.133”. Both 1910.132 and 1910.133 OSHA standards require use of personal protective equipment, including eye and face protection.

9.2 Enhanced Bioretention Media Testing

The following SAP recommendations are based on past experience and specific guidance provided in DEMEAU (2014):

- The enhanced BSM testing will use real stormwater for the column experiments to account for the effect of influent water quality on load removal. A stormwater

collection site will need to be identified in a watershed with typical PCB concentrations to ensure PCB concentrations are representative of those expected in Bay Area urban watersheds. Also, guidance will need to be developed on mobilization to ensure storms are targeted randomly.

- Stormwater properties are known to change significantly with time due to natural flocculation and settling of particles. Appropriate procedures should be developed to ensure collected stormwater is well mixed at all times, and experiments are performed in a timely manner to insure the stormwater used is representative.
- PCBs can readily attach to test equipment, including the inside of tubing that may be used for pumps and the inside of PVC columns. Alternatives should be considered that eliminate the need for pumping equipment and reduce attachment within columns (e.g., by use of glass columns).
- The results of column experiments can be affected by channeling and wall effects. Use a column diameter to particle diameter ratio greater than about 40 to minimize these.
- How media is packed in columns will affect infiltration rates and treatment performance. Therefore, detailed procedures should be developed for the packing of media in columns to ensure consistency between columns and between experiments.

9.3 Data Quality Objectives

Data quality objectives (DQOs) should follow standard stormwater monitoring protocols and be described in detail in individual SAPs. Both sampling and laboratory data quality objectives should be included. For sampling, the SAP should specify sediment and water collection procedures and equipment as well as sample volume and handling requirements. For laboratories, numeric DQOs are appropriate for sample blanks, duplicates (or field splits), and matrix spike recovery.

10. References

BASMAA, 2013. Quality Assurance Project Plan (QAPP). Clean Watersheds for a Clean Bay – Implementing the San Francisco Bay’s PCBs and Mercury TMDLs with a Focus on Urban Runoff. August 15, 2013.

BASMAA, 2014. Integrated Monitoring Report Part B: PCB and Mercury Loads Avoided and Reduced via Stormwater Control Measures. Bay Area Stormwater Management Agencies Association.

BASMAA, 2016a. Regional Biotreatment Soil Specification: Specification of Soils for Biotreatment or Bioretention Facilities. Bay Area Stormwater Management Agencies Association.

BASMAA, 2016b. Interim Accounting Methodology for TMDL Loads Reduced. Bay Area Stormwater Management Agencies Association.

BASMAA, 2017a. Clean Watersheds for a Clean Bay Project Report, Final Report May 2017. Bay Area Stormwater Management Agencies Association.

BASMAA, 2017b. Clean Watersheds for a Clean Bay Task 5: Stormwater Treatment Retrofit Pilot Projects Stormwater Treatment Retrofit - 7th Street Hydrodynamic Separator Unit draining the Leo Avenue Watershed, San Jose, CA. Bay Area Stormwater Management Agencies Association.

BASMAA, 2017c. Bay Area Reasonable Assurance Analysis Guidance Document. Project Number: WW2282, June 2017. Bay Area Stormwater Management Agencies Association.

Caltrans, 2009. BMP Pilot Study Guidance Manual. Document No. CTSW-RT-06-171.02.1. California Department of Transportation, Sacramento.

Caltrans, 2015. Caltrans Stormwater Monitoring Guidance Manual, November 2015. Document No. CTSW-OT-15-999.43.01. California Department of Transportation, Sacramento.

City of San Diego, 2012. Catch Basin Inlet Cleaning Pilot Study Final Report, June 2012. The City of San Diego, California.

City of Spokane, 2015. PCB Characterization of Spokane Regional Vector Waste Decant Facilities, Prepared for the Spokane River Regional Toxics Taskforce September, 2015. City of Spokane RPWRF Laboratory.

City of Tacoma, 2015. East Tacoma PCB Investigation: Results & Next Steps. November 20, 2013. City of Tacoma Environmental Services.

[City of Tacoma PCB Presentation](#). Last Assessed May 28, 2017.

DEMEAU, 2014. Guidelining protocol for soil-column experiments assessing fate and transport of trace organics. Demonstration of promising technologies to address emerging pollutants in water and waste water project. European Union Seventh Programme for Research, Technological Development and Demonstration under Grant Agreement No. 308330.

Gomez-Eyles, J. L., C. Yupanqui, B. Beckingham, G. Riedel, C. Gilmour, and U. Ghosh, 2013. Evaluation of Biochars and Activated Carbons for In Situ Remediation of Sediments Impacted with Organics, Mercury, and Methylmercury. *Environ. Sci. Technol.*, 47, 13721–13729.

Kitsap County, 2015. Analysis of Bioretention Soil Media for Improved Nitrogen, Phosphorus and Copper Retention, Final Report. Kitsap County Public Works, Washington.

Liu, P., C. J. Ptacek, D. W. Blowes, and R. C. Landis, 2015. Mechanisms of mercury removal by biochars produced from different feedstocks determined using X-ray absorption spectroscopy. *Journal of Hazardous Materials*, 308 (2016) 233–242.

SFBRWQCB, 2012. San Francisco Bay Regional Water Quality Control Board. Total Maximum Daily Loads (TMDLs) and the 303(d) List of Impaired Water Bodies. 2012.

SFBRWQCB, 2015. Municipal Regional Stormwater NPDES Permit, Order No. R2-2015-0049. NPDES Permit No. CAS612008. November 19, 2015

SFEI, 2015. Sources, Pathways and Loadings: Multi-Year Synthesis with a Focus on PCBs and Hg. Report for Regional Monitoring Program for Water Quality in San Francisco Bay (RMP), Sources Pathways and Loadings Workgroup (SPLWG), Small Tributaries Loading Strategy (STLS). 2015.

WERF, 2009. Urban Stormwater BMP Performance Monitoring. Water Environment Research Foundation.

[Urban Stormwater BMP Performance Monitoring](#). Last accessed August 6, 2012.

Wilson M. A., O. Mohseni, J. S. Gulliver, R. M. Hozalski, and H. G. Stefan, 2009. Assessment of Hydrodynamic Separators for Storm-Water Treatment. *J. Hydraul. Eng.*, 2009, 135(5): 383-392.

Yargicoglu, E. N. and K. R. Reddy, 2015. Characterization and Surface Analysis of Commercially Available Biochars for Geoenvironmental Applications. IFCEE2015, San Antonio, TX, March 17-21, 2015.

Yee, D., and L. J. McKee, 2010. Task 3.5: Concentrations of PCBs and Hg in soils, sediments and water in the urbanized Bay Area: Implications for best management. A technical report of the Watershed Program. SFEI Contribution 608. San Francisco Estuary Institute, Oakland CA.

APPENDIX B: SAMPLING AND ANALYSIS PLAN AND QUALITY ASSURANCE
PROJECT PLAN

BASMAA Regional Monitoring Coalition

Pollutants of Concern Monitoring for Source Identification and Management Action Effectiveness, 2017-2018

Sampling and Analysis Plan and Quality Assurance Project Plan

Prepared for:

The Bay Area Stormwater Management Agencies Association (BASMAA)

Prepared by:



1410 Jackson Street
Oakland, CA
94612



6000 J Street
Sacramento, CA
95819



4911 Central Avenue
Richmond, CA
94804

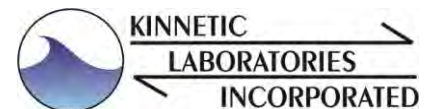

307 Washington Street
Santa Cruz, CA
95060

Version 2
September 29, 2017

Title and Approval Sheet

Program Title Pollutants of Concern (POC) Monitoring for Source Identification
and Management Action Effectiveness

Lead Organization Bay Area Stormwater Management Agencies Association (BASMAA)

P.O. Box 2385, Menlo Park, CA 94026, 510-622-2326

info@basmaa.org

Primary Contact Geoff Brosseau

Effective Date September 29, 2017

Revision Number Version 2

Approval Signatures:

A signature from the BASMAA Executive Director approving the BASMAA POC Monitoring for Source Identification and Management Action Effectiveness is considered approval on behalf of all Program Managers.

Geoff Brosseau

Date

TABLE OF CONTENTS

TITLE AND APPROVAL SHEET 2
 APPROVAL SIGNATURES: 2

1. PROBLEM DEFINITION/BACKGROUND 9
 1.1. PROBLEM STATEMENT 9
 1.2. OUTCOMES..... 10

2. DISTRIBUTION LIST AND CONTACT INFORMATION..... 11

3. PROGRAM ORGANIZATION 11
 3.1. INVOLVED PARTIES AND ROLES..... 11
 3.2. BASMAA PROJECT MANAGER (BASMAA-PM) 12
 3.3. BASMAA PROJECT MANAGEMENT TEAM (PMT)..... 13
 3.4. CONSULTANT TEAM PROJECT MANAGER (CONSULTANT-PM) 13
 3.5. QUALITY ASSURANCE OFFICER (QA OFFICER)..... 13
 3.6. DATA MANAGER (DM) 13
 3.7. FIELD CONTRACTOR PROJECT MANAGER (FIELD-PM) 13
 3.8. LABORATORY PROJECT MANAGER (LAB-PM)..... 14
 3.1. REPORT PREPARER..... 14

4. MONITORING PROGRAM DESCRIPTION..... 14
 4.1. WORK STATEMENT AND PROGRAM OVERVIEW 14
 4.2. SAMPLING DETAIL..... 15
 4.2.1. Task 1 - Caulk/Sealant samples 15
 4.2.2. Task 2 - Sediment samples from HDS Units 16
 4.2.3. Task 3 - Storm Water and Column Test Samples 16
 4.3. SCHEDULE..... 17
 4.4. GEOGRAPHICAL SETTING 17
 4.5. CONSTRAINTS 17

5. MEASUREMENT QUALITY OBJECTIVES (MQO) 18
 5.1. REPRESENTATIVENESS AND COMPARABILITY 18
 5.2. COMPLETENESS 19
 5.3. SENSITIVITY 19
 5.4. PRECISION 19
 5.5. ACCURACY..... 20
 5.6. CONTAMINATION..... 20

6. SPECIAL TRAINING NEEDS / CERTIFICATION 21

7. PROGRAM DOCUMENTATION AND REPORTING 21
 7.1. FIELD DOCUMENTATION..... 22
 7.1.1. Sampling Plans, COCs, and Sampling Reports 22
 7.1.2. Data Sheets 22
 7.1.3. Photographic Documentation..... 22
 7.2. LABORATORY DOCUMENTATION 22
 7.2.1. Data Reporting Format..... 22
 7.2.2. Other Laboratory QA/QC Documentation..... 23
 7.3. PROGRAM MANAGEMENT DOCUMENTATION..... 24
 7.3.1. SAP/QAPP 24
 7.3.2. Program Information Archival..... 24
 7.4. REPORTING..... 25

8.	SAMPLING PROCESS DESIGN	25
8.1.	CAULK/SEALANT SAMPLING.....	25
8.2.	SEDIMENT QUALITY SAMPLING	25
8.3.	WATER QUALITY SAMPLING	26
8.4.	SAMPLING UNCERTAINTY	26
9.	SAMPLING METHODS.....	26
9.1.	CAULK/SEALANT SAMPLING (TASK 1).....	27
9.1.1.	<i>Sample Site Selection.....</i>	27
9.1.2.	<i>Initial Equipment Cleaning</i>	27
9.1.3.	<i>Field Cleaning Protocol.....</i>	27
9.1.4.	<i>Blind Sampling Procedures.....</i>	27
9.1.5.	<i>Caulk/Sealant Collection Procedures.....</i>	28
9.1.6.	<i>Sample ID Designation</i>	29
9.2.	HDS UNIT SAMPLING PROCEDURES (TASK 2)	29
9.2.1.	<i>Sample Site Selection.....</i>	29
9.2.2.	<i>Field Equipment and Cleaning.....</i>	29
9.2.3.	<i>Soil / Sediment Sample Collection</i>	30
9.2.4.	<i>Sample ID Designation</i>	31
9.3.	WATER QUALITY SAMPLING AND COLUMN TESTING PROCEDURES (TASK 3)	32
9.3.1.	<i>Sample Site Selection.....</i>	32
9.3.2.	<i>Field Equipment and Cleaning.....</i>	32
9.3.3.	<i>Water Sampling Procedures.....</i>	32
9.3.4.	<i>Hydraulic Testing.....</i>	32
9.3.5.	<i>Column Testing Procedures</i>	33
9.3.6.	<i>Sample ID Designations</i>	34
9.4.	COLLECTION OF SAMPLES FOR ARCHIVING.....	35
9.5.	WASTE DISPOSAL.....	35
9.5.1.	<i>Routine Garbage.....</i>	35
9.5.2.	<i>Detergent Washes.....</i>	35
9.5.3.	<i>Chemicals.....</i>	35
9.1.	RESPONSIBILITY AND CORRECTIVE ACTIONS	35
9.2.	STANDARD OPERATING PROCEDURES.....	35
10.	SAMPLE HANDLING AND CUSTODY.....	36
10.1.	SAMPLING CONTAINERS.....	36
10.2.	SAMPLE PRESERVATION	37
10.3.	PACKAGING AND SHIPPING	37
10.4.	COMMERCIAL VEHICLE TRANSPORT.....	37
10.5.	SAMPLE HOLD TIMES	37
11.	FIELD HEALTH AND SAFETY PROCEDURES	39
12.	LABORATORY ANALYTICAL METHODS	39
12.1.	CAULK/SEALANT SAMPLES (TASK 1).....	39
12.1.1.	<i>XRF Chlorine analysis.....</i>	39
12.1.2.	<i>Selection of Samples for PCB analysis and Compositing.....</i>	39
12.1.3.	<i>Sample Preparation</i>	40
12.1.4.	<i>PCBs Analysis.....</i>	40
12.2.	SEDIMENT SAMPLES COLLECTED FROM HDS UNITS (TASK 2).....	41
12.3.	WATER SAMPLES – STORMWATER AND COLUMN TESTS (TASK 3).....	41
12.4.	METHOD FAILURES.....	41

12.5.	SAMPLE DISPOSAL.....	42
12.6.	LABORATORY SAMPLE PROCESSING	42
13.	QUALITY CONTROL.....	42
13.1.	FIELD QUALITY CONTROL.....	42
13.1.1.	<i>Field Blanks</i>	43
13.1.2.	<i>Field Duplicates</i>	43
13.1.3.	<i>Field Corrective Action</i>	43
13.2.	LABORATORY QUALITY CONTROL.....	44
13.2.1.	<i>Calibration and Working Standards</i>	45
13.2.2.	<i>Instrument Calibration</i>	45
13.2.3.	<i>Initial Calibration Verification</i>	45
13.2.4.	<i>Continuing Calibration Verification</i>	45
13.2.5.	<i>Laboratory Blanks</i>	46
13.2.6.	<i>Reference Materials and Demonstration of Laboratory Accuracy</i>	46
13.2.7.	<i>Reference Materials vs. Certified Reference Materials</i>	46
13.2.8.	<i>Laboratory Control Samples</i>	47
13.2.9.	<i>Prioritizing Certified Reference Materials, Reference Materials, and Laboratory Control Samples</i>	47
13.2.10.	<i>Matrix Spikes</i>	47
13.2.11.	<i>Laboratory Duplicates</i>	48
13.2.12.	<i>Laboratory Duplicates vs. Matrix Spike Duplicates</i>	48
13.2.13.	<i>Replicate Analyses</i>	48
13.2.14.	<i>Surrogates</i>	48
13.2.15.	<i>Internal Standards</i>	48
13.2.16.	<i>Dual-Column Confirmation</i>	49
13.2.17.	<i>Dilution of Samples</i>	49
13.2.18.	<i>Laboratory Corrective Action</i>	49
14.	INSPECTION/ACCEPTANCE FOR SUPPLIES AND CONSUMABLES	56
15.	NON DIRECT MEASUREMENTS, EXISTING DATA	56
16.	DATA MANAGEMENT	56
16.1.	FIELD DATA MANAGEMENT	56
16.2.	LABORATORY DATA MANAGEMENT	56
17.	ASSESSMENTS AND RESPONSE ACTIONS	57
17.1.	READINESS REVIEWS.....	57
17.2.	POST SAMPLING EVENT REVIEWS.....	57
17.3.	LABORATORY DATA REVIEWS	57
18.	INSTRUMENT/EQUIPMENT TESTING, INSPECTION AND MAINTENANCE	58
18.1.	FIELD EQUIPMENT	58
18.2.	LABORATORY EQUIPMENT	58
19.	INSTRUMENT/EQUIPMENT CALIBRATION AND FREQUENCY	59
19.1.	FIELD MEASUREMENTS.....	59
19.2.	LABORATORY ANALYSES.....	59
19.2.1.	<i>In-house Analysis – XRF Screening</i>	59
19.2.2.	<i>Contract Laboratory Analyses</i>	59
20.	DATA REVIEW, VERIFICATION, AND VALIDATION	60
21.	VERIFICATION AND VALIDATION METHODS	61

22.	RECONCILIATION WITH USER REQUIREMENTS.....	61
23.	REFERENCES.....	62
24.	APPENDIX A: FIELD DOCUMENTATION	63
25.	APPENDIX B: LABORATORY STANDARD OPERATING PROCEDURES (SOPS).....	69

List of Tables

TABLE 2-1. BASMAA SAP/QAPP DISTRIBUTION LIST	11
TABLE 3-1. SAN FRANCISCO BAY AREA STORMWATER PROGRAMS AND ASSOCIATED MRP PERMITTEES PARTICIPATING IN THE BASMAA MONITORING PROGRAM.....	12
TABLE 7-1. DOCUMENT AND RECORD RETENTION, ARCHIVAL, AND DISPOSITION	24
TABLE 7-2. MONITORING PROGRAM FINAL REPORTING DUE DATES.	25
TABLE 9-1 FIELD EQUIPMENT FOR HDS UNIT SAMPLING.....	30
TABLE 9-2 STATION CODES FOR STORMWATER INFLUENT SAMPLES AND COLUMN TESTS.	35
TABLE 9-3. LIST OF BASMAA RMC SOPS UTILIZED BY THE MONITORING PROGRAM.....	36
TABLE 10-1 SAMPLE HANDLING FOR THE MONITORING PROGRAM ANALYTES BY MEDIA TYPE.	38
TABLE 12-1. LABORATORY ANALYTICAL METHODS FOR ANALYTES IN SEDIMENT.....	41
TABLE 12-2. LABORATORY ANALYTICAL METHODS FOR ANALYTES IN WATER.....	41
TABLE 13-1. MEASUREMENT QUALITY OBJECTIVES - PCBs.	50
TABLE 13-2. MEASUREMENT QUALITY OBJECTIVES – INORGANIC ANALYTES.....	51
TABLE 13-3. MEASUREMENT QUALITY OBJECTIVES – CONVENTIONAL ANALYTES.	52
TABLE 13-4. TARGET MRLS FOR SEDIMENT QUALITY PARAMETERS.	52
TABLE 13-5. TARGET MRLS FOR PCBs IN WATER, SEDIMENT AND CAULK.....	53
TABLE 13-6. SIZE DISTRIBUTION CATEGORIES FOR GRAIN SIZE IN SEDIMENT.....	54
TABLE 13-7. TARGET MRLS FOR TOC, SSC, AND MERCURY IN WATER	54
TABLE 13-8. CORRECTIVE ACTION – LABORATORY AND FIELD QUALITY CONTROL.....	55
TABLE 14-1. INSPECTION / ACCEPTANCE TESTING REQUIREMENTS FOR CONSUMABLES AND SUPPLIES.....	56

List of Acronyms

ACCWP	Alameda Countywide Clean Water Program
ALS	ALS Environmental Laboratory
BASMAA	Bay Area Stormwater Management Agencies Association
BSM	Bioretention Soil Media
CCCWP	Contra Costa Clean Water Program
CCV	continuing calibration verification
CEDEN	California Environmental Data Exchange Network
CEH	Center for Environmental Health
COC	Chain of Custody
Consultant-PM	Consultant Team Project Manager
CRM	Certified Reference Material
CSE	Confined Space Entry
ECD	Electron capture detection
EDD	Electronic Data Deliverable
EOA	Eisenberg, Olivieri & Associates, Inc.
EPA	Environmental Protection Agency (U.S.)
FD	Field duplicate
Field PM	Field Contractor Project Manager
FSURMP	Fairfield-Suisun Urban Runoff Management Program
GC-MS	Gas Chromatography-Mass Spectroscopy
IDL	Instrument Detection Limits
ICV	initial calibration verification
KLI	Kinnetic Laboratories Inc.
LCS	Laboratory Control Samples
Lab-PM	Laboratory Project Manager
MS/MSD	Matrix Spike/Matrix Spike Duplicate
MDL	Method Detection Limit
MQO	Measurement Quality Objective
MRL	Method Reporting Limit
MRP	Municipal Regional Permit
NPDES	National Pollutant Discharge Elimination System
OWP-CSUS	Office of Water Programs at California State University Sacramento
PCB	Polychlorinated Biphenyl
PM	Project Manager
PMT	Project Management Team
POC	Pollutants of Concern
QA	Quality Assurance
QA Officer	Quality Assurance Officer
QAPP	Quality Assurance Project Plan
QC	Quality Control
ROW	Right-of-way
RPD	Relative Percent Difference
RMC	Regional Monitoring Coalition
RMP	Regional Monitoring Program for Water Quality in the San Francisco Estuary
SFRWQCB	San Francisco Regional Water Quality Control Board (Regional Water Board)
SAP	Sampling and Analysis Plan
SCCVURPP	Santa Clara Valley Urban Runoff Pollution Prevention Program
SCVWD	Santa Clara Valley Water Department
SFEI	San Francisco Estuary Institute

SMCWPPP	San Mateo County Water Pollution Prevention Program
SOP	Standard Operating Procedure
SWAMP	California Surface Water Ambient Monitoring Program
TOC	Total Organic Carbon
TMDL	Total Maximum Daily Load
VSFCD	Vallejo Sanitation and Flood Control District

1. Problem Definition/Background

The Bay Area Stormwater Management Agencies Association (BASMAA) member agencies will implement a regional monitoring program for Pollutants of Concern (POC) Monitoring for Source Identification and Management Action Effectiveness (Monitoring Program). The Monitoring Program is intended to fulfill components of the Municipal Regional Stormwater NPDES Permit (MRP; Order No. R2-2015-0049), which implements the polychlorinated biphenyls (PCBs) and Mercury Total Maximum Daily Loads (TMDLs) for the San Francisco Bay Area. Monitoring for Source Identification and Management Action Effectiveness are two of five monitoring priorities for POCs identified in the MRP. Source identification monitoring is conducted to identify the sources or watershed source areas that provide the greatest opportunities for reductions of POCs in urban stormwater runoff. Management action effectiveness monitoring is conducted to provide support for planning future management actions or to evaluate the effectiveness or impacts of existing management actions.

BASMAA developed two study designs to implement each component of the Monitoring Program. The *Evaluation of PCBs Presence in Public Roadway and Storm Drain Infrastructure Caulk and Sealants Study Design* (BASMAA 2017a) addresses the source identification monitoring requirements of Provision C.8.f, as well as requirements of Provision C.12.e to investigate PCBs in infrastructure caulk and sealants. The *POC Monitoring for Management Action Effectiveness Study Design* (BASMAA 2017b) addresses the management action effectiveness monitoring requirements of Provision C.8.f. The results of the Monitoring Program will contribute to ongoing efforts by MRP Permittees to identify PCB sources and improve the PCBs and mercury treatment effectiveness of stormwater control measures in the Phase I permittee area of the Bay Area. This Sampling and Analysis Plan and Quality Assurance Project Plan (SAP/QAPP) was developed to guide implementation of both components of the Monitoring Program.

1.1. Problem Statement

Fish tissue monitoring in San Francisco Bay (Bay) has revealed bioaccumulation of PCBs and mercury. The measured fish tissue concentrations are thought to pose a health risk to people consuming fish caught in the Bay. As a result of these findings, California has issued an interim advisory on the consumption of fish from the Bay. The advisory led to the Bay being designated as an impaired water body on the Clean Water Act "Section 303(d) list" due to PCBs and mercury. In response, the California Regional Water Quality Control Board, San Francisco Bay Region (Regional Water Board) has developed TMDL water quality restoration programs targeting PCBs and mercury in the Bay. The general goals of the TMDLs are to identify sources of PCBs and mercury to the Bay and implement actions to control the sources and restore water quality.

Since the TMDLs were adopted, Permittees have conducted a number of projects to provide information that supports implementation of management actions designed to achieve the wasteload allocations described in the Mercury and PCBs TMDL, as required by Provisions of the MRP. The Clean Watersheds for a Clean Bay project (CW4CB) was a collaboration among BASMAA member agencies that pilot tested various stormwater control measures and provided estimates of the PCBs and mercury load reduction effectiveness of these controls (BASMAA, 2017c). However, the results of the CW4CB project identified a number of remaining data gaps on the load reduction effectiveness of the control measures

that were tested. In addition, MRP Provisions C.8.f. and C.12.e require Permittees to conduct further source identification and management action effectiveness monitoring during the current permit term.

1.2. Outcomes

The Monitoring Program will allow Permittees to satisfy MRP monitoring requirements for source identification and management action effectiveness, while also addressing some of the data gaps identified by the CW4CB project (BASMAA, 2017c). Specifically, the Monitoring Program is intended to provide the following outcomes:

1. Satisfy MRP Provision C.8.f. requirements for POC monitoring for source identification; and Satisfy MRP Provision C.12.e.ii requirements to evaluate PCBs presence in caulks/sealants used in storm drain or roadway infrastructure in public ROWs;
 - a. Report the range of PCB concentrations observed in 20 composite samples of caulk/sealant collected from structures installed or rehabilitated during the 1970's;
2. Satisfy MRP Provision C.8.f. requirements for POC monitoring for management action effectiveness;
 - a. Quantify the annual mass of mercury and PCBs captured in HDS Unit sumps during maintenance; and
 - b. Identify bioretention soil media (BSM) mixtures for future field testing that provide the most effective mercury and PCBs treatment in laboratory column tests.

The information generated from the Monitoring Program will be used by MRP Permittees and the Regional Water Board to better understand potential PCB sources and better estimate the load reduction effectiveness of current and future stormwater control measures.

2. Distribution List and Contact Information

The distribution list for this BASMAA SAP/QAPP is provided in Table 2-1.

Table 2-1. BASMAA SAP/QAPP Distribution List.

Project Group	Title	Name and Affiliation	Telephone No.
BASMAA Project Management Team	BASMAA Project Manager, Stormwater Program Specialist	Reid Bogert, SMCWPPP	650-599-1433
	Program Manager	Jim Scanlin, ACCWP	510-670-6548
	Watershed Management Planning Specialist	Lucile Paquette, CCCWP	925-313-2373
	Program Manager	Rachel Kraai, CCCWP	925-313-2042
	Technical Consultant to ACCWP and CCCWP	Lisa Austin, Geosyntec Inc. CCCWP	510-285-2757
	Supervising Environmental Services Specialist	James Downing, City of San Jose	408-535-3500
	Senior Environmental Engineer	Kevin Cullen, FSURMP	707-428-9129
	Pollution Control Supervisor	Doug Scott, VSFCO	707-644-8949 x269
Consultant Team	Project Manager	Bonnie de Berry, EOA Inc.	510-832-2852 x123
	Assistant Project Manager SAP/QAPP Author and Report Preparer	Lisa Sabin, EOA Inc.	510-832-2852 x108
	Technical Advisor	Chris Sommers, EOA Inc.	510-832-2852 x109
	Study Design Lead and Report Preparer	Brian Currier, OWP-CSUS	916-278-8109
	Study Design Lead and Report Preparer	Dipen Patel, OWP-CSUS	
	Technical Advisor	Lester McKee, SFEI	415-847-5095
	Quality Assurance Officer	Don Yee, SFEI	510-746-7369
	Data Manager	Amy Franz, SFEI	510-746-7394
Project Laboratories	Field Contractor Project Manager	Jonathan Toal, KLI	831-457-3950
	Laboratory Project Manager	Howard Borse, ALS	360-430-7733
	XRF Laboratory Project Manager	Matt Nevins, CEH	510-655-3900 x318

3. Program Organization

3.1. Involved Parties and Roles

BASMAA is a 501(c)(3) non-profit organization that coordinates and facilitates regional activities of municipal stormwater programs in the San Francisco Bay Area. BASMAA programs support implementation of the MRP (Order No. R2-2015-0049), which implements the PCBs and Mercury TMDLs for the San Francisco Bay Area. BASMAA is comprised of all 76 identified MRP municipalities and special districts, the Alameda Countywide Clean Water Program (ACCWP), Contra Costa Clean

Water Program (CCCWP), the Santa Clara Valley Urban Runoff Pollution Prevention Program (SCVURPPP), the San Mateo Countywide Water Pollution Prevention Program (SMCWPPP), the Fairfield-Suisun Urban Runoff Management Program (FSURMP), the City of Vallejo and the Vallejo Sanitation and Flood Control District (VSFCD) (Table 3-1).

MRP Permittees have agreed to collectively implement this Monitoring Program via BASMAA. The Program will be facilitated through the BASMAA Monitoring and Pollutants of Concern Committee (MPC). BASMAA selected a consultant team to develop and implement the Monitoring Program with oversight and guidance from a BASMAA Project Management Team (PMT), consisting of representatives from BASMAA stormwater programs and municipalities (Table 3-1).

Table 3-1. San Francisco Bay Area Stormwater Programs and Associated MRP Permittees Participating in the BASMAA Monitoring Program.

Stormwater Programs	MRP Permittees
Santa Clara Valley Urban Runoff Pollution Prevention Program (SCVURPPP)	Cities of Campbell, Cupertino, Los Altos, Milpitas, Monte Sereno, Mountain View, Palo Alto, San Jose, Santa Clara, Saratoga, Sunnyvale, Los Altos Hills, and Los Gatos; Santa Clara Valley Water District; and, Santa Clara County
Alameda Countywide Clean Water Program (ACCWP)	Cities of Alameda, Albany, Berkeley, Dublin, Emeryville, Fremont, Hayward, Livermore, Newark, Oakland, Piedmont, Pleasanton, San Leandro, and Union City; Alameda County; Alameda County Flood Control and Water Conservation District; and, Zone 7 Water District
Contra Costa Clean Water Program (CCCWP)	Cities of, Clayton, Concord, El Cerrito, Hercules, Lafayette, Martinez, , Orinda, Pinole, Pittsburg, Pleasant Hill, Richmond, San Pablo, San Ramon, Walnut Creek, Danville, and Moraga; Contra Costa County; and, Contra Costa County Flood Control and Water Conservation District
San Mateo County Wide Water Pollution Prevention Program (SMCWPPP)	Cities of Belmont, Brisbane, Burlingame, Daly City, East Palo Alto, Foster City, Half Moon Bay, Menlo Park, Millbrae, Pacifica, Redwood City, San Bruno, San Carlos, San Mateo, South San Francisco, Atherton, Colma, Hillsborough, Portola Valley, and Woodside; San Mateo County Flood Control District; and, San Mateo County
Fairfield-Suisun Urban Runoff Management Program (FSURMP)	Cities of Fairfield and Suisun City
Vallejo Permittees (VSFCD)	City of Vallejo and Vallejo Sanitation and Flood Control District

3.2. BASMAA Project Manager (BASMAA-PM)

The BASMAA Project Manager (BASMAA-PM) will be responsible for directing the activities of the below-described PMT, and will provide oversight and managerial level activities, including reporting status updates to the PMT and BASMAA, and acting as the liaison between the PMT and the Consultant Team. The BASMAA PM will oversee preparation, review, and approval of project deliverables, including the required reports to the Regional Water Board.

3.3. BASMAA Project Management Team (PMT)

The BASMAA PMT will assist the BASMAA-PM and the below described Consultant Team with the design and implementation of all project activities. PMT members will assist the BASMAA-PM and Consultant Team to complete project activities within scope, on-time, and within budget by having specific responsibility for planning and oversight of project activities within the jurisdiction of the BASMAA agency that they represent. In addition, the PMT will coordinate with the municipal project partners and key regional agencies, including the Regional Water Board. The PMT is also responsible for reviewing and approving project deliverables (e.g., draft and final project reports).

3.4. Consultant Team Project Manager (Consultant-PM)

The Consultant Team Project Manager (Consultant-PM) will be responsible for ensuring all work performed during the Monitoring Program is consistent with project goals, and provide oversight of all day-to-day operations associated with implementing all components of the Monitoring Program, including scheduling, budgeting, reporting, and oversight of subcontractors. The Consultant-PM will ensure that data generated and reported through implementation of the Monitoring Program meet measurement quality objectives (MQOs) described in this SAP/QAPP. The Consultant -PM will work with the Quality Assurance Officer as required to resolve any uncertainties or discrepancies. The Consultant -PM will also be responsible for overseeing development of draft and final reports for the Monitoring Program, as described in this SAP/QAPP.

3.5. Quality Assurance Officer (QA Officer)

The role of the Quality Assurance Officer (QA Officer) is to provide independent oversight and review of the quality of the data being generated. In this role, the QA Officer has the responsibility to require data that is of insufficient quality to be flagged, or not used, or for work to be redone as necessary so that the data meets specified quality measurements. The QA Officer will oversee the technical conduct of the field related components of the Monitoring Program, including ensuring field program compliance with the SAP/QAPP for tasks overseen at the programmatic level.

3.6. Data Manager (DM)

The Data Manager will be responsible for receipt and review of all project related documentation and reporting associated with both field efforts and laboratory analysis. The Data Manager will also be responsible for storage and safekeeping of these records for the duration of the project.

3.7. Field Contractor Project Manager (Field-PM)

The Field Contractor Project Manager (Field-PM) will be responsible for conduct and oversight of all field monitoring- and reporting-related activities, including completion of field datasheets, chain of custodies, and collection of field measurements and field samples, consistent with the monitoring methods and procedures in the SAP/QAPP. The Field-PM will also be responsible for ensuring that personnel conducting monitoring are qualified to perform their responsibilities and have received appropriate training. The Field-PM will be responsible for initial receipt and review of all project related documentation and reporting associated with both field efforts and laboratory analysis.

The Field-PM will also be responsible for receiving all samples collected opportunistically by participating municipalities, including all caulk/sealant samples, initial review of sample IDs to ensure there are no duplicate sample IDs, and shipping the samples under COC to the appropriate laboratory (CEH for the caulk/sealant samples; ALS for all other samples). Participating municipalities should ship all samples they collect to the Field PM at the following address:

Jon Toal
Kinnetic Laboratories, Inc.
307 Washington Street
Santa Cruz, CA 95060
Reference: BASMAA POC Monitoring Project
(831)457-3950

3.8. Laboratory Project Manager (Lab-PM)

The Laboratory Project Manager (Lab-PM) and chemists at each analytical laboratory will be responsible for ensuring that the laboratory's quality assurance program and standard operating procedures (SOPs) are consistent with this SAP/QAPP, and that laboratory analyses meet all applicable requirements or explain any deviations. Each Lab-PM will also be responsible for coordinating with the Field-PM and other staff (e.g., Consultant -PM, Data Manager, QA Officer) and facilitating communication between the Field-PM, the Consultant -PM, and analytical laboratory personnel, as required for the project.

The Center for Environmental Health (CEH) will provide chlorine content screening of all caulk/sealant samples collected using X-Ray Fluorescence (XRF) technology to assist in selection of samples for further laboratory analysis of PCBs. This XRF-screening will also provide additional information on the utility of XRF in prioritizing samples for chemical PCBs analyses.

All other laboratory analyses will be provided by ALS Environmental.

3.1. Report Preparer

The Report Preparer (RP) will be responsible for developing draft and final reports for each of the following components of the Monitoring Program: (1) Source identification; and (2) Management action effectiveness. All draft reports will be submitted to the PMT for review and input prior to submission for approval by the BASMAA Board of Directors (BOD).

4. Monitoring Program Description

4.1. Work Statement and Program Overview

The Monitoring Program consists of the following three major tasks, each of which has a field sampling component:

- **Task 1. Evaluate presence and possible concentrations of PCBs in roadway and storm drain infrastructure caulk and sealants.** This task involves analysis of 20 composite samples of caulk/sealant collected from public roadway and storm drain infrastructure throughout the permit

area to investigate PCB concentrations. The goal of this task is to evaluate, at a limited screening level, whether and in what concentrations PCBs are present in public roadway and storm drain infrastructure caulk and sealants in the portions of the Bay Area under the jurisdiction of the Phase I Permittees identified in Table 3-1 (Bay Area).

- **Task 2. Evaluate Annual mass of PCBs and mercury captured in Hydrodynamic Separator (HDS) Unit sumps during maintenance.** This task involves collecting sediment samples from the sumps of public HDS unit during maintenance cleanouts to evaluate the mass of PCBs and mercury captured by these devices. The goal of this task is to provide data to better characterize the concentrations of POCs in HDS Unit sump sediment and improve estimates of the mass captured and removed from these units during current maintenance practices for appropriate TMDL load reduction crediting purposes.
- **Task 3. Bench-scale testing of the mercury and PCBs removal effectiveness of selected BSM mixtures enhanced with biochar.** This task involves collecting stormwater from the Bay Area that will then be used to conduct laboratory column tests designed to evaluate the mercury and PCBs treatment effectiveness of various biochar-amended BSM mixtures. Real stormwater will be used for the column tests to account for the effect of influent water quality on load removal. The goal of this task is to identify BSM mixtures amended with biochar that meet operational infiltration requirements and are effective for PCBs and mercury removal for future field testing.

All monitoring results and interpretations will be documented in BASMAA reports for submission to the Regional Water Board according to the schedule in the MRP.

4.2. Sampling Detail

The Monitoring Program includes three separate sampling tasks that involve collection and analysis of the following types of samples: caulk/sealants (Task 1); sediment from HDS units (Task 2); and stormwater collected and used for column tests in the lab (Task 3). Additional details specific to the sampling design for each task are provided below.

4.2.1. Task 1 - Caulk/Sealant samples

The PMT will recruit municipal partners from within each stormwater program to participate in this task. All caulk/sealant samples will be collected from locations within public roadway or storm drain infrastructure in the participating municipalities. Exact sample sites will be identified based on available information for each municipal partner, including: age of public infrastructure; records of infrastructure repair or rehabilitation (aiming for the late 1960s through the 1970s); and current municipal staff knowledge about locations that meet the site selection criteria identified in the study design (BASMAA, 2017a). Field crews led by the Field-PM and/or municipal staff will conduct field reconnaissance to further identify specific sampling locations and if feasible, will collect caulk/sealant samples during these initial field visits. Follow-up sampling events will be conducted for any sites that require additional planning or equipment for sample collection (e.g., confined space entry, parking controls, etc.). Sample locations will include any of the following public infrastructure where caulk/sealant are present: roadway or sidewalk surfaces, between expansion joints for roadways, parking garages, bridges, dams, or storm drain pipes, and/or in pavement joints (e.g., curb and gutter). Sampling will only occur during periods of dry weather when urban runoff flows through any structures that will be sampled are minimal, and do not

present any safety hazards or other logistical issues during sample collection. Sample collection methods are described further in Section 9.

As opportunities arise, municipal staff will also collect samples following the methods and procedures described in this SAP/QAPP during ongoing capital projects that provide access to public infrastructure locations with caulk/sealant that meet the sample site criteria. All samples collected by participating municipal staff will be delivered to the Field PM under COC. The Field-PM will be responsible for storing all caulk/sealant samples and shipping the samples under COC to CEH for XRF screening analysis.

All caulk/sealant samples collected will be screened for chlorine content using XRF technology described in Section 9. Samples will be grouped for compositing purposes as described in the study design (BASMAA, 2017a). Up to three samples will be included per composite and a total of 20 composite caulk/sealant samples will be analyzed for the RMP 40 PCB congeners¹. All compositing and PCBs analysis will be conducted blind to the location where each sample was collected. Laboratory analysis methods must be able to detect a minimum PCBs concentration of 200 parts per billion (ppb, or $\mu\text{g}/\text{Kg}$). Laboratory analytical methods are described further in Section 12. The range of PCB concentrations found in caulk based on this documented sampling design will be reported to the Regional Water Board within the Permittees' 2018 Annual Reports.

4.2.2.Task 2 - Sediment samples from HDS Units

The PMT will recruit municipal partners that maintain public HDS units to participate in this task. All sediment samples will be collected from the sump of selected HDS units during scheduled cleaning and maintenance. Selection of the HDS units for sampling will be opportunistic, based on the units that are scheduled for maintenance by participating municipalities during the project period. Field crews led by the Field-PM and municipal maintenance staff will coordinate sampling with scheduled maintenance events. As needed, municipal staff will dewater the HDS unit sumps prior to sample collection, and provide assistance to field crews with access to the sump sediment as needed (e.g., confined space entry, parking controls, etc.). All sump sediment samples will be collected following the methods and procedures described in this SAP/QAPP. Sampling will only occur during periods of dry weather when urban runoff flows into the HDS unit sumps are minimal, and do not present any safety hazards or other logistical issues during sample collection. Sample collection methods are described further in Section 9.

All sediment samples collected will be analyzed for the RMP 40 PCB congeners, total mercury, total organic carbon (TOC), particle size distribution (PSD), and bulk density. Laboratory analytical methods are described further in Section 12. The range of PCB and mercury concentrations observed in HDS Unit sump sediments and the annual pollutant masses removed during cleanouts will be reported to the Regional Water Board in March 2019.

4.2.3.Task 3 - Storm Water and Column Test Samples

This task will collect stormwater from Bay Area locations that will then be used as the influent for column tests of biochar-amended BSM. Bay Area stormwater samples will be collected from locations

¹ The 40 individual congeners routinely quantified by the Regional Monitoring Program (RMP) for Water Quality in the San Francisco Estuary include: PCBs 8, 18, 28, 31, 33, 44, 49, 52, 56, 60, 66, 70, 74, 87, 95, 97, 99, 101, 105, 110, 118, 128, 132, 138, 141, 149, 151, 153, 156, 158, 170, 174, 177, 180, 183, 187, 194, 195, 201, and 203

within public roadway or storm drain infrastructure in participating municipalities. Field personnel lead by the Field PM will collect stormwater samples during three qualifying storm events and ensure all samples are delivered to the lab of OWP at CSUS within 24-hours of collection. Stormwater will be collected from one watershed that has a range of PCB concentrations and is considered representative of Bay Area watersheds (e.g. the West Oakland Ettie Street Pump Station watershed). Storms from the representative watershed should be targeted randomly without bias, thereby accounting for the effects of storm intensity and ensuring variability in contaminant concentration, proportion of dissolved contaminants, particle size, particle size distribution, and particle density. To achieve this, minimal mobilization criteria should be used to ensure predicted storm intensity and runoff volume are likely to yield the desired volume. Sample collection methods are described further in Section 9.

The stormwater collected will be used as the influent for column tests of various BSM mixtures amended with biochar. These tests will be implemented in three phases. First, hydraulic screening tests will be performed to ensure all amended BSM mixtures meet the MRP infiltration rate requirements of 12 in/h initial maximum infiltration or minimum 5 in/h long-term infiltration rate. Second, column tests will be performed using Bay Area stormwater to evaluate pollutant removal. Third, additional column tests will be performed using lower concentration (e.g., diluted) Bay Area stormwater to evaluate relative pollutant removal performance at lower concentrations. Further details about the column testing are provided in Section 9.3.

All influent and effluent water samples collected will be analyzed for the RMP 40 PCB congeners, total mercury, suspended sediment concentrations (SSC), TOC, and turbidity. Laboratory analytical methods are described further in Section 12. The range of PCB and mercury concentrations observed in influent and effluent water samples and the associated pollutant mass removal efficiencies for each BSM mixture tested will be reported to the Regional Water Board in March 2019.

4.3. Schedule

Caulk/sealant sampling (Task 1) will be conducted between July 2017 and December 2017. HDS Unit sampling (Task 2) will be conducted between July 2017 and May 2018. Stormwater sample collection and BSM column tests (Task 3) will occur between October 2017 – April 2018.

4.4. Geographical Setting

Field operations will be conducted across multiple Phase I cities in the San Francisco Bay region within the counties of San Mateo, Santa Clara, Alameda, and Contra Costa, and the City of Vallejo.

4.5. Constraints

Caulk/sealant sampling and HDS unit sampling will only be conducted during dry weather, when urban runoff flows through the sampled structures are minimal and do not present safety hazards or other logistical concerns. Caulk/sealant sampling will be limited to the caulk/sealant available and accessible at sites that meet the project site criteria (described in the Study Design, BASMAA 2017a). HDS unit sampling will be limited by the number of public HDS units that are available for maintenance during the project period. Extreme wet weather may pose a safety hazard to sampling personnel and may therefore impact wet season sampling.

5. Measurement Quality Objectives (MQO)

The quantitative measurements that estimate the true value or concentration of a physical or chemical property always involve some level of uncertainty. The uncertainty associated with a measurement generally results from one or more of several areas: (1) natural variability of a sample; (2) sample handling conditions and operations; (3) spatial and temporal variation; and (4) variations in collection or analytical procedures. Stringent Quality Assurance (QA) and Quality Control (QC) procedures are essential for obtaining unbiased, precise, and representative measurements and for maintaining the integrity of the sample during collection, handling, and analysis, as well as for measuring elements of variability that cannot be controlled. Stringent procedures also must be applied to data management to assure that accuracy of the data is maintained.

MQOs are established to ensure that data collected are sufficient and of adequate quality for the intended use. MQOs include both quantitative and qualitative assessment of the acceptability of data. The qualitative goals include representativeness and comparability, and the quantitative goals include completeness, sensitivity (detection and quantization limits), precision, accuracy, and contamination.

MQOs associated with representativeness, comparability, completeness, sensitivity, precision, accuracy, and contamination are presented below in narrative form.

5.1. Representativeness and Comparability

The representativeness of data is the ability of the sampling locations and the sampling procedures to adequately represent the true condition of the sample sites. The comparability of data is the degree to which the data can be compared directly between all samples collected under this SAP/QAPP. Field personnel, including municipal personnel that collect samples, will strictly adhere to the field sampling protocols identified in this SAP/QAPP to ensure the collection of representative, uncontaminated, comparable samples. The most important aspects of quality control associated with chemistry sample collection are as follows:

- Field personnel will be thoroughly trained in the proper use of sample collection equipment and will be able to distinguish acceptable versus unacceptable samples in accordance with pre-established criteria.
- Field personnel are trained to recognize and avoid potential sources of sample contamination (e.g., dirty hands, insufficient field cleaning).
- Samplers and utensils that come in direct contact with the sample will be made of non-contaminating materials, and will be thoroughly cleaned between sampling stations.
- Sample containers will be pre-cleaned and of the recommended type.
- All sampling sites will be selected according to the criteria identified in the project study design (BASMAA, 2017a)

Further, the methods for collecting and analyzing PCBs in infrastructure caulk and sealants will be comparable to other studies of PCBs in building material and infrastructure caulk (e.g., Klosterhaus et al., 2014). This SAP/QAPP was also developed to be comparable with the California Surface Water Ambient Monitoring Program (SWAMP) Quality Assurance Program Plan (QAPrP, SWAMP 2013). All sediment

and water quality data collected during the Monitoring Program will be performed in a manner so that data are SWAMP comparable².

5.2. Completeness

Completeness is defined as the percentage of valid data collected and analyzed compared to the total expected to be obtained under normal operating conditions. Overall completeness accounts for both sampling (in the field) and analysis (in the laboratory). Valid samples include those for analytes in which the concentration is determined to be below detection limits.

Under ideal circumstances, the objective is to collect 100 percent of all field samples desired, with successful laboratory analyses on 100% of measurements (including QC samples). However, circumstances surrounding sample collections and subsequent laboratory analysis are influenced by numerous factors, including availability of infrastructure meeting the required sampling criteria (applies to both infrastructure caulk sampling and HDS Unit sampling), flow conditions, weather, shipping damage or delays, sampling crew or lab analyst error, and QC samples failing MQOs. An overall completeness of greater than 90% is considered acceptable for the Monitoring Program.

5.3. Sensitivity

Different indicators of the sensitivity of an analytical method to measure a target parameter are often used including instrument detection limits (IDLs), method detection limits (MDLs), and method reporting limits (MRLs). For the Monitoring Program, MRL is the measurement of primary interest, consistent with SWAMP Quality Assurance Project Plan (SWAMP 2013). Target MRLs for all analytes by analytical method provided in Section 13.

5.4. Precision

Precision is used to measure the degree of mutual agreement among individual measurements of the same property under prescribed similar conditions. Overall precision usually refers to the degree of agreement for the entire sampling, operational, and analysis system. It is derived from reanalysis of individual samples (laboratory replicates) or multiple collocated samples (field replicates) analyzed on equivalent instruments and expressed as the relative percent difference (RPD) or relative standard deviation (RSD). Analytical precision can be determined from duplicate analyses of field samples, laboratory matrix spikes/matrix spike duplicates (MS/MSD), laboratory control samples (LCS) and/or reference material samples. Analytical precision is expressed as the RPD for duplicate measurements:

$$RPD = \text{ABS} ([X1 - X2] / [(X1 + X2) / 2])$$

Where: X1 = the first sample result
X2 = the duplicate sample result.

² SWAMP data templates and documentation are available online at
http://waterboards.ca.gov/water_issues/programs/swamp/data_management_resources/templates_docs.shtml

Precision will be assessed during the Monitoring Program by calculating the RPD of laboratory replicate samples and/or MS/MSD samples, which will be run at a frequency of 1 per analytical batch for each analyte. Target RPDs for the Monitoring Program are identified in Section 13.

5.5. Accuracy

Accuracy describes the degree of agreement between a measurement (or the average of measurements of the same quantity) and its true environmental value, or an acceptable reference value. The “true” values of the POCs in the Monitoring Program are unknown and therefore “absolute” accuracy (and representativeness) cannot be assessed. However, the analytical accuracy can be assessed through the use of laboratory MS samples, and/or LCS. For MS samples, recovery is calculated from the original sample result, the expected value (EV = native + spike concentration), and the measured value with the spike (MV):

$$\% \text{ Recovery} = (MV - N) \times 100\% / (EV - N)$$

Where: MV = the measured value
EV = the true expected (reference) value
N = the native, unspiked result

For LCS, recovery is calculated from the concentration of the analyte recovered and the true value of the amount spiked:

$$\% \text{ Recovery} = (X / TV) \times 100\%$$

Where: X = concentration of the analyte recovered
TV = concentration of the true value of the amount spiked

Surrogate standards are also spiked into samples for some analytical methods (i.e., PCBs) and used to evaluate method and instrument performance. Although recoveries on surrogates are to be reported, control limits for surrogates are method and laboratory specific, and no project specific recovery targets for surrogates are specified, so long as overall recovery targets for accuracy (with matrix spikes) are achieved. Where surrogate recoveries are applicable, data will not be reported as surrogate-corrected values.

Analytical accuracy will be assessed during the Monitoring Program based on recovery of the compound of interest in matrix spike and matrix spike duplicates compared with the laboratory’s expected value, at a frequency of 1 per analytical batch for each analyte. Recovery targets for the Monitoring Program are identified in Section 13.

5.6. Contamination

Collected samples may inadvertently be contaminated with target analytes at many points in the sampling and analytical process, from the materials shipped for field sampling, to the air supply in the analytical laboratory. When appropriate, blank samples evaluated at multiple points in the process chain help assure that compound of interest measured in samples actually originated from the target matrix in the sampled environment and are not artifacts of the collection or analytical process.

Method blanks (also called laboratory reagent blanks, extraction blanks, procedural blanks, or preparation blanks) are used by laboratory personnel to assess laboratory contamination during all stages of sample preparation and analysis. The method blank is processed through the entire analytical procedure in a manner identical to the samples. A method blank concentration should be less than the RL or should not exceed a concentration of 10% of the lowest reported sample concentration. A method blank concentration greater than 10% of the lowest reported sample concentration will require corrective action to identify and eliminate the source(s) of contamination before proceeding with sample analysis. If eliminating the blank contamination is not possible, all impacted analytes in the analytical batch shall be flagged. In addition, a detailed description of the likely contamination source(s) and the steps taken to eliminate/minimize the contaminants shall be included in narrative of the data report. If supporting data is presented demonstrating sufficient precision in blank measurement that the 99% confidence interval around the average blank value is less than the MDL or 10% of the lowest measured sample concentration, then the average blank value may be subtracted.

A field blank is collected to assess potential sample contamination levels that occur during field sampling activities. Field blanks are taken to the field, transferred to the appropriate container, preserved (if required by the method), and treated the same as the corresponding sample type during the course of a sampling event. The inclusion of field blanks is dependent on the requirements specified in the relevant MQO tables or in the sampling method.

6. Special Training Needs / Certification

All fieldwork will be performed by contractor staff that has appropriate levels of experience and expertise to conduct the work, and/or by municipal staff that have received the appropriate instruction on sample collection, as determined by the Field PM and/or the PMT. The Field-PM will ensure that all members of the field crew (including participating municipal staff) have received appropriate instructions based on methods described in this document (Section 9) for collecting and transporting samples. As appropriate, sampling personnel may be required to undergo or have undergone OSHA training / certification for confined space entry in order to undertake particular aspects of sampling within areas deemed as such.

Analytical laboratories are to be certified for the analyses conducted at each laboratory by ELAP, NELAP, or an equivalent accreditation program as approved by the PMT. All laboratory personal will follow methods described in Section 13 for analyzing samples.

7. Program Documentation and Reporting

The Consultant Team in consultation with the PMT will prepare draft and final reports of all monitoring data, including statistical analysis and interpretation of the data, as appropriate, which will be submitted to the BASMAA BOD for approval. Following approval by the BASMAA BOD, Final project reports will be available for submission with each stormwater program's Annual Report in 2018 (Task 1) or in the March 31, 2019 report to the Regional Water Board (Tasks 2 and 3). Procedures for overall management of project documents and records and report preparation are summarized below.

7.1. Field Documentation

All field data gathered for the project are to be recorded in field datasheets, and scanned or transcribed to electronic documents as needed to permit easy access by the PMT, the consultant team, and other appropriate parties.

7.1.1. Sampling Plans, COCs, and Sampling Reports

The Field-PM will be responsible for development and submission of field sampling reports to the Data Manager and Consultant-PM. Field crews will collect records for sample collection, and will be responsible for maintaining these records in an accessible manner. Samples sent to analytical laboratories will include standard Chain of Custody (COC) procedures and forms; field crews will maintain a copy of originating COCs at their individual headquarters. Analytical laboratories will collect records for sample receipt and storage, analyses, and reporting. All records, except lab records, generated by the Monitoring Program will be stored at the office of the Data Manager for the duration of the project, and provided to BASMAA at the end of the project.

7.1.2. Data Sheets

All field data gathered by the Monitoring Program will be recorded on standardized field data entry forms. The field data sheets that will be used for each sampling task are provided in Appendix A.

7.1.3. Photographic Documentation

Photographic documentation is an important part of sampling procedures. An associated photo log will be maintained documenting sites and subjects associated with photos. If an option, the date function on the camera shall be turned on. Field Personnel will be instructed to take care to avoid any land marks when taking photographs, such as street signs, names of buildings, road mile markers, etc. that could be used later to identify a specific location. A copy of all photographs should be provided at the conclusion of sampling efforts and maintained for project duration.

7.2. Laboratory Documentation

The Monitoring Program requires specific actions to be taken by contract laboratories, including requirements for data deliverables, quality control, and on-site archival of project-specific information. Each of these aspects is described below.

7.2.1. Data Reporting Format

Each laboratory will deliver data in electronic formats to the Field-PM, who will transfer the records to the Data Manager, who is responsible for storage and safekeeping of these records for the duration of the project. In addition, each laboratory will deliver narrative information to the QA Officer for use in data QA and for long-term storage.

The analytical laboratory will report the analytical data to the Field-PM via an analytical report consisting of, at a minimum:

1. Letter of transmittal
2. Chain of custody information
3. Analytical results for field and quality control samples (Electronic Data Deliverable, EDD)
4. Case narrative

5. Copies of all raw data.

The Field-PM will review the data deliverables provided by the laboratory for completeness and errors. The QA Officer will review the data deliverables provided by the laboratory for review of QA/QC. In addition to the laboratory's standard reporting format, all results meeting MQOs and results having satisfactory explanations for deviations from objectives shall be reported in tabular format on electronic media. SWAMP-formatted electronic data deliverable (EDD) templates are to be agreed upon by the Data Manager, QA Officer, and the Lab-PM prior to onset of any sampling activities related to that laboratory.

Documentation for analytical data is kept on file at the laboratories, or may be submitted with analytical results. These may be reviewed during external audits of the Monitoring Program, as needed. These records include the analyst's comments on the condition of the sample and progress of the analysis, raw data, and QC checks. Paper or electronic copies of all analytical data, field data forms and field notebooks, raw and condensed data for analysis performed on-site, and field instrument calibration notebooks are kept as part of the Monitoring Program archives for a minimum period of eight years.

7.2.2. Other Laboratory QA/QC Documentation

All laboratories will have the latest version of this Monitoring Program SAP/QAPP in electronic format. In addition, the following documents and information from the laboratories will be current, and they will be available to all laboratory personnel participating in the processing of samples:

1. Laboratory QA plan: Clearly defines policies and protocols specific to a particular laboratory, including personnel responsibilities, laboratory acceptance criteria, and corrective actions to be applied to the affected analytical batches, qualification of data, and procedures for determining the acceptability of results.
2. Laboratory Standard Operation Procedures (SOPs): Contain instructions for performing routine laboratory procedures, describing exactly how a method is implemented in the laboratory for a particular analytical procedure. Where published standard methods allow alternatives at various steps in the process, those approaches chosen by the laboratory in their implementation (either in general or in specific analytical batches) are to be noted in the data report, and any deviations from the standard method are to be noted and described.
3. Instrument performance information: Contains information on instrument baseline noise, calibration standard response, analytical precision and bias data, detection limits, scheduled maintenance, etc.
4. Control charts: Control charts are developed and maintained throughout the Program for all appropriate analyses and measurements for purposes of determining sources of an analytical problem or in monitoring an unstable process subject to drift. Control charts serve as internal evaluations of laboratory procedures and methodology and are helpful in identifying and correcting systematic error sources. Control limits for the laboratory quality control samples are ± 3 standard deviations from the certified or theoretical concentration for any given analyte.

Records of all quality control data, maintained in a bound notebook at each workstation, are signed and dated by the analyst. Quality control data include documentation of standard calibrations, instrument

maintenance and tests. Control charts of the data are generated by the analysts monthly or for analyses done infrequently, with each analysis batch. The laboratory quality assurance specialist will review all QA/QC records with each data submission, and will provide QA/QC reports to the Field-PM with each batch of submitted field sample data.

7.3. Program Management Documentation

The BASMAA-PM and Consultant-PM are responsible for managing key parts of the Monitoring Program’s information management systems. These efforts are described below.

7.3.1.SAP/QAPP

All original SAP/QAPPs will be held by the Consultant-PM. This SAP/QAPP and its revisions will be distributed to all parties involved with the Monitoring Program. Copies will also be sent to the each participating analytical laboratory's contact for internal distribution, preferably via electronic distribution from a secure location.

Associated with each update to the SAP/QAPP, the Consultant-PM will notify the BASMAA-PM and the PMT of the updated SAP/QAPP, with a cover memo compiling changes made. After appropriate distributions are made to affected parties, these approved updates will be filed and maintained by the SAP/QAPP Preparers for the Monitoring Program. Upon revision, the replaced SAP/QAPPs will be discarded/deleted.

7.3.2.Program Information Archival

The Data Manager and Consultant-PM will oversee the actions of all personnel with records retention responsibilities, and will arbitrate any issues relative to records retention and any decisions to discard records. Each analytical laboratory will archive all analytical records generated for this Program. The Consultant-PM will be responsible for archiving all management-level records.

Persons responsible for maintaining records for this Program are shown in Table 7-1.

Table 7-1. Document and Record Retention, Archival, and Disposition

Type	Retention (years)	Archival	Disposition
Field Datasheets	8	Data Manager	Maintain indefinitely
Chain of Custody Forms	8	Data Manager	Maintain indefinitely
Raw Analytical Data	8	Laboratory	Recycling
Lab QC Records	8	Laboratory	Recycling
Electronic data deliverables	8	Data Manager	Maintain indefinitely
Reports	8	Consultant-PM	Maintain indefinitely

As discussed previously, the analytical laboratory will archive all analytical records generated for this Program. The Consultant-PM will be responsible for archiving all other records associated with implementation of the Monitoring Program.

All field operation records will be entered into electronic formats and maintained in a dedicated directory managed by the BASMAA-PM.

7.4. Reporting

The Consultant team will prepare draft and final reports for each component of the Monitoring Program. The PMT will provide review and input on draft reports and submit to the BASMAA BOD for approval. Once approved by the BASMAA BOD, the Monitoring Program reports will be available to each individual stormwater program for submission to the Regional Water Board according to the schedule outlined in the MRP and summarized in Table 7.2.

Table 7-2. Monitoring Program Final Reporting Due Dates.

Monitoring Program Component	Task	MRP Reporting Due Date
Source Identification	Task 1 - Evaluation of PCB concentrations in roadway and storm drain infrastructure caulk and sealants	September 30, 2018
Management Action Effectiveness	Task 2 - Evaluation of the annual mass of PCBs and mercury captured in HDS Unit sump sediment	March 31, 2019
	Task 3 - Bench-scale testing of the mercury and PCBs removal effectiveness of selected BSM mixtures.	

8. Sampling Process Design

All information generated through conduct of the Monitoring Program will be used to inform TMDL implementation efforts for mercury and PCBs in the San Francisco Bay region. The Monitoring Program will implement the following tasks: (1) evaluate the presence and concentrations of PCB in caulk and sealants from public roadway and stormdrain infrastructure; (2) evaluate mass of PCBs and mercury removed during HDS Unit maintenance; and (3) evaluate the mercury and PCBs treatment effectiveness of various BSM mixtures in laboratory column tests using stormwater collected from Bay Area locations. Sample locations and the timing of sample collection will be selected using the directed sampling design principle. This is a deterministic approach in which points are selected deliberately based on knowledge of their attributes of interest as related to the environmental site being monitored. This principle is also known as "judgmental," "authoritative," "targeted," or "knowledge-based." Individual monitoring aspects are summarized further under Field Methods (Section 9) and in the task-specific study designs (BASMAA 2017a,b).

8.1. Caulk/Sealant Sampling

Caulk/sealant sampling will support the Monitoring Program's Task 1 to evaluate PCBs in roadway and stormdrain infrastructure caulk/sealant, as described previously (see Section 4). Further detail on caulk/sealant sampling methods and procedures are provided under Field Methods (Section 9).

8.2. Sediment Quality Sampling

Sediment sampling will support the Monitoring Program's Task 2 to evaluate the mass of mercury and PCBs removed during HDS unit maintenance, as described previously (see Section 4). Further detail on

sediment sampling methods and procedures are provided under Field Methods (Section 9).

8.3. Water Quality Sampling

Water sampling will support the Monitoring Program's Task 3 to evaluate the mercury and PCBs treatment effectiveness of various BSM mixtures, as described previously (see Section 4). Further detail on water sampling methods and procedures are provided under Field Methods (Section 9).

8.4. Sampling Uncertainty

There are multiple sources of potential sampling uncertainty associated with the Monitoring Program, including: (1) measurement error; (2) natural (inherent) variability; (3) undersampling (or poor representativeness); and (4) sampling bias (statistical meaning). Measures incorporated to address these areas of uncertainty are discussed below:

(1) Measurement error combines all sources of error related to the entire sampling and analysis process (i.e., to the measurement system). All aspects of dealing with uncertainty due to measurement error have been described elsewhere within this document.

(2) Natural (inherent) variability occurs in any environment monitored, and is often much wider than the measurement error. Prior work conducted by others in the field of stormwater management have demonstrated the high degree of variability in environmental media, which will be taken into consideration when interpreting results of the various lines of inquiry.

(3) Under- or unrepresentative sampling happens at the level of an individual sample or field measurement where an individual sample collected is a poor representative for overall conditions encountered given typical sources of variation. To address this situation, the Monitoring Program will be implementing a number of QA-related measures described elsewhere within this document, including methods refined through implementation of prior, related investigations.

(4) Sampling bias relates to the sampling design employed and whether the appropriate statistical design is employed to allow for appropriate understanding of environmental conditions. To a large degree, the sampling design required by the Monitoring Program is judgmental, which will therefore incorporate an unknown degree of sampling bias into the Project. There are small measures that have been built into the sampling design to combat this effect (e.g., homogenization of sediments for chemistry analyses), but overall this bias is a desired outcome designed to meet the goals of this Monitoring Program, and will be taken into consideration when interpreting results of the various investigations.

Further detail on measures implemented to reduce uncertainty through mobilization, sampling, sample handling, analysis, and reporting phases are provided throughout this document.

9. Sampling Methods

The Monitoring Program involves the collection of three types of samples: Caulk/sealants; sediment from HDS unit sumps; and water quality samples. Field collection will be conducted by field contractors or municipal staff using a variety of sampling protocols, depending on the media and parameter monitored. These methods are presented below. In addition, the Monitoring Program will utilize several field

sampling SOPs previously developed by the BASMAA Regional Monitoring Coalition identified in Table 9-3 (RMC, BASMAA, 2016).

9.1. Caulk/Sealant Sampling (Task 1)

Procedures for collecting caulk and sealant samples are not well established. Minimal details on caulk or sealant sample collection methodologies are available in peer-reviewed publications. The caulk/sealant sampling procedures described here were adapted from a previous study examining PCBs in building materials conducted in the Bay Area (Klosterhaus et al., 2014). The methods described by Klosterhaus et al. (2014) were developed through consultation with many of the previous authors of caulk literature references therein, in addition to field experience gained during the Bay Area study. It is anticipated that lessons will also be learned during the current study.

9.1.1. Sample Site Selection

Once a structure has been identified as meeting the selection criteria and permission is granted to perform the testing or collection of sealant samples, an on-site survey of the structure will be used to identify sealant types and locations on the structure to be sampled. It is expected that sealants from a number of different locations on each structure may be sampled; however, inconspicuous locations on the structure will be targeted.

9.1.2. Initial Equipment Cleaning

The sampling equipment that is pre-cleaned includes:

- Glass sample jars
- Utility knife, extra blades
- Stainless-steel forceps

Prior to sampling, all equipment will be thoroughly cleaned. Glass sample containers will be factory pre-cleaned (Quality Certified™, ESS Vial, Oakland, CA) and delivered to field team at least one week prior to the start of sample collection. Sample containers will be pre-labeled and kept in their original boxes, which will be transported in coolers. Utility knife blades, forceps, stainless steel spoons, and chisels will be pre-cleaned with Alconox, Liquinox, or similar detergent, and then rinsed with deionized water and methanol. The cleaned equipment will then be wrapped in methanol-rinsed aluminum foil and stored in clean Ziploc bags until used in the field.

9.1.3. Field Cleaning Protocol

Between each use the tool used (utility knife blade, spoon or chisel) and forceps will be rinsed with methanol and then deionized water, and inspected to ensure all visible sign of the previous sample have been removed. The clean tools, extra blades, and forceps will be kept in methanol-rinsed aluminum foil and stored in clean Ziploc bags when not in use.

9.1.4. Blind Sampling Procedures

The intention of this sampling is to better determine whether sealants in road and storm drain infrastructure contain PCBs at concentrations of concern, and to understand the relative importance of PCBs in this infrastructure among the other known sources of PCBs that can affect San Francisco Bay. At this phase of the project, we are not seeking to identify specific facilities requiring mitigation (if PCBs are

identified, this could be a future phase). Therefore, in this initial round of sampling, we are not identifying sample locations, but instead implementing a blind sampling protocol, as follows:

- All samples will be collected without retaining any information that would identify structure locations. The information provided to the contractor on sampling locations will not be retained. Structure location information will not be recorded on any data sheets or in any data spreadsheets or other electronic computer files created for the Project. Physical sealant samples collected will be identified only by a sample identification (ID) designation (Section 4). Physical sealant sample labels will contain only the sample ID (see Section 4 and example label in Appendix A). Samples will be identified only by their sample ID on the COC forms.
- As an added precaution and if resources allow, oversampling will occur such that more samples will be collected than will be sent to the laboratory for compositing and analysis. In this case, the Project team would select a subset of samples for PCB analysis based on factors such as application type and/or chlorine content, but blind to the specific location where each sample was collected.
- Up to three individual sealant samples will be composited by the laboratory prior to analysis for PCBs, following instructions from the Consultant PM. This further ensures a blind sampling approach because samples collected at different locations will be analyzed together.

9.1.5.Caulk/Sealant Collection Procedures

At each sample location, the Field-PM, and/or municipal staff, will make a final selection of the most accessible sampling points at the time of sampling. From each point sampled, a one inch strip (aiming for about 10 g of material) of caulk or sealant will be removed from the structure using one of the following solvent-rinsed tools: a utility knife with a stainless-steel blade, stainless steel spoon to scrape off the material, or a stainless steel chisel. The Field-PM or municipal staff at the site will select the appropriate tool based on the conditions of the caulk/sealant at each sample point. Field personnel will wear nitrile gloves during sample collection to reduce potential sample contamination. The sample will then be placed in a labeled, factory-cleaned glass jar. For each caulk sample collected, field personnel will fill out a field data sheet at the time of sample collection, which includes the following information:

- Date and time of sample collection,
- sample identification designation,
- qualitative descriptions of relevant structure or caulk/sealant features, including use profile, color and consistency of material collected, surface coating (paint, oily film, masonry residues etc.)
- crack dimensions, the length and/or width of the caulk bead sampled, spacing of expansion joints in a particular type of application, and
- a description of any unusual occurrences associated with the sampling event (especially those that could affect sample or data quality).

Appendix A contains an example field data sheet. All samples will be kept in a chilled cooler in the field (i.e., at $4\text{ }^{\circ}\text{C} \pm 2\text{ }^{\circ}\text{C}$), and kept refrigerated pending delivery under COC to the Field PM at KLI. Further, the field data sheets will remain with the samples when they are shipped to KLI, and will then be maintained by the Field PM at KLI.

As needed, the procedure for replacement of the caulk/sealant will be coordinated with the appropriate municipal staff to help ensure that the sampling does not result in damage to the structure.

9.1.6. Sample ID Designation

Every sample must have a unique sample ID to ensure analytical results from each sample can be differentiated from every other sample. This information should follow the sample through the COC, analytical, and interpretation and reporting processes. For the infrastructure caulk/sealant samples, the sample ID must not contain information that can be used to identify where the sample was collected. The following 2-step process will be followed to assign sample IDs to the caulk/sealant samples.

1. Upon collection, the sample will be labeled according to the following naming convention:

MMDDYYYY-TTTT-##

Where:

MM	2 digit month of collection
DD	2 digit date of collection
YYYY	4 digit year of collection
TTTT	4 digit time of collection (military time)
##	Sequential 2-digit sample number (i.e., 01, 02, 03...etc.)

For example, a sample collected on September 20, 2017 at 9 AM could be assigned the following sample ID: 09202017-0900-01.

2. This second step was added to avoid issues that could arise due to duplicate sample IDs, while maintaining the blind sampling approach. While the sample naming system identified above is unlikely to produce duplicate sample IDs, there is a chance that different groups may collect samples simultaneously. This second step will be implemented by the Field PM at KLI upon receipt of caulk/sealant samples from participating municipalities. The Field PM at KLI will review the sample IDs on the COC forms for all samples and compare the sample IDs to all caulk samples for this project already in storage at KLI. If any two samples have the same sample IDs, the Field PM will add a one-digit number to the end of one of the sample IDs, selected at random. This extra number will be added to the sample container label, the field data sheet, and the COC form for that sample.

9.2. HDS Unit Sampling Procedures (Task 2)

9.2.1. Sample Site Selection

Sample site selection will be opportunistic, based on the public HDS units that participating municipalities schedule for cleaning during the project. The project team will coordinate with participating municipalities to schedule sampling during HDS unit cleanouts.

9.2.2. Field Equipment and Cleaning

A list of potential sampling equipment for soil/sediment is presented in Table 5. The equipment list should be reviewed and tailored by field contractors to meet the needs of each individual sampling site. Appropriate sampling equipment is prepared in the laboratory a minimum of four days prior to sampling. Prior to sampling, all equipment will be thoroughly cleaned. Equipment is soaked (fully immersed) for three days in a solution of Alconox, Liquinox, or similar phosphate-free detergent and deionized water. Equipment is then rinsed three times with deionized water. Equipment is next rinsed with a dilute solution

(1-2%) of hydrochloric acid, followed by a rinse with reagent grade methanol, followed by another set of three rinses with deionized water. All equipment is then allowed to dry in a clean place. The cleaned equipment is then wrapped in aluminum foil or stored in clean Ziploc bags until used in the field.

Table 9-1 Field Equipment for HDS Unit Sampling.

Description of Equipment	Material (if applicable)
Sample scoops	Stainless steel or Kynar coated
Sample trowels	Stainless steel or Kynar coated
Compositing bucket	Stainless steel or Kynar coated
Ekman Dredge (as needed)	Stainless steel
Sample containers (with labels)	As coordinated with lab(s)
Methanol, Reagent grade (Teflon squeeze bottle with refill)	
Hydrochloric acid, 1-2%, Reagent grade (Teflon squeeze bottle)	
Liquinox detergent (diluted in DI within Teflon squeeze bottle)	
Deionized / reverse osmosis water	
Plastic scrub brushes	
Container for storage of sampling derived waste, dry	
Container for storage of sampling derived waste, wet	
Wet ice	
Coolers, as required	
Aluminum foil (heavy duty recommended)	
Protective packaging materials	Bubble / foam bags
Splash proof eye protection	
PPE for sampling personnel, including traffic mgmt as required	
Gloves for dry ice handling	Cotton, leather, etc.
Gloves for sample collection, reagent handling	Nitrile
Field datasheets	
COC forms	
Custody tape (as required)	
Shipping materials (as required)	
GPS	

9.2.3. Soil / Sediment Sample Collection

Field sampling personnel will collect sediment samples from HDS unit sumps using methods that minimize contamination, losses, and changes to the chemical form of the analytes of interest. The samples will be collected in the field into pre-cleaned sample containers of a material appropriate to the analysis to be conducted. Pre-cleaned sampling equipment is used for each site, whenever possible and/or when necessary. Appropriate sampling technique and measuring equipment may vary depending on the location, sample type, sampling objective, and weather. Additional safety measures may be necessary in some cases; for example, if traffic control or confined space entry is required to conduct the sampling.

Ideally and where a sufficient volume of soil/sediment allows, samples are collected into a composite container, where they are thoroughly homogenized, and then aliquoted into separate jars for chemical analysis. Sediment samples for metals and organics are submitted to the analytical laboratories in separate jars, which have been pre-cleaned according to laboratory protocol. It is anticipated that soil / solid media will be collected for laboratory analysis using one of two techniques: (1) Remote grab of submerged sediments within HDS unit sumps using Ekman dredge or similar; or (2) direct grab sampling of

sediments after dewatering HDS unit sumps using individual scoops, push core sampling, or similar. Each of these techniques is described briefly below.

- **Soil and Sediment Samples, Submerged.** Wet soil and sediment samples may be collected from within HDS unit sumps. Sample crews must exercise judgment on whether submerged samples can be collected in a manner that does not substantially change the character of the soil/sediment collected for analysis (e.g., loss of fine materials). It is anticipated that presence of trash within the sumps may interfere with sample collection by preventing complete grab closure and loss of significant portion of the sample. Field crews will have the responsibility to determine the best method for collection of samples within each HDS Unit sump. If sampling personnel determine that sample integrity cannot be maintained throughout collection process, it is preferable to cancel sampling operations rather than collect samples with questionable integrity. This decision making process is more fully described in Section 11, Field Variances.
- **Soil and Sediment Samples, Dry.** Soils / sediments may be collected from within the HDS unit sump after dewatering. Field crews will have the responsibility to identify areas of sediment accumulation within areas targeted for sampling and analysis, and determine the best method for collection of samples with minimal disturbance to the sampling media.

After collection, all soil/sediment samples for PCBs and mercury analyses will be homogenized and transferred from the sample-dedicated homogenization pail into factory-supplied wide-mouth glass jars using a clean trowel or scoop. The samples will be transferred to coolers containing double-bagged wet ice and chilled to 6°C immediately upon collection.

For each sample collected, field personnel will fill out a field data sheet at the time of sample collection. Appendix A contains an example field data sheet. All samples will be kept in a chilled cooler in the field, and kept refrigerated pending delivery under COC to the field-PM. The Field PM will be responsible for sending the samples in a single batch to CEH for XRF analysis under COC. Following XRF analysis, CEH will deliver the samples under COC to the Consultant-PM. The Consultant-PM will be responsible for working with the project team to group samples for compositing, and sending those samples to the analytical laboratory under COC.

9.2.4. Sample ID Designation

Every sample must have a unique sample ID so that the analytical results from each sample can be differentiated from every other sample. This information should follow the sample through the COC, analytical, and interpretation and reporting processes. Each sediment/soil sample collected from HDS units will be labeled according to the following naming convention:

MMM-UUU-##

where:

MMM	Municipal Abbreviation (i.e., SJC=San Jose; OAK=Oakland; SUN=Sunnyvale).
UUU	HDS Unit Catchment ID; this is the number provided by the municipality for a specific HDS unit.
##	Sequential Sample Number (i.e., 01, 02, 03...etc.)

9.3. Water Quality Sampling and Column Testing Procedures (Task 3)

For this task, monitoring will be conducted during three storm events. The stormwater collected during these events will then be used as the influent for the laboratory column tests of amended BSM mixtures. Four influent samples (i.e., one sample of Bay Area stormwater from each of the three monitored storm events plus one diluted stormwater sample) and 20 effluent samples from the column tests that includes 3 tests for each of the six columns, plus one test with the diluted stormwater in two columns (one test column and one control column) will be collected and analyzed for pollutant concentrations.

9.3.1. Sample Site Selection

Two stormwater collection sites have been selected based on influent PCB concentrations measured during CW4CB (BASMAA, 2017c). Both sites are near tree wells located on Ettie Street in West Oakland. The first site is the influent to tree well #6 (station code = TW6). During CW4CB, influent stormwater concentrations at this location were average to high, ranging from 30 ng/L to 286 ng/L. Stormwater collected from this site will be used as the influent for one of the main column tests and some water will be reserved for the dilution series column tests. The amount of dilution will be determined after results are received from the lab from the first run. The second site is the influent to tree well #2 (station code=TW2). During CW4CB, influent stormwater concentrations at this location were low to average, ranging from 6 ng/L to 39 ng/L. Stormwater collected from this site will be used for the remaining two main column tests..

9.3.2. Field Equipment and Cleaning

Field sampling equipment includes:

1. Borosilicate glass carboys
2. Glass sample jars
3. Peristaltic pump tubing

Prior to sampling, all equipment will be thoroughly cleaned. Glass sample containers and peristaltic pump tubing will be factory pre-cleaned. Prior to first use and after each use, glass carboys (field carboys and effluent collection carboys) will be washed using phosphate-free laboratory detergent and scrubbed with a plastic brush. After washing the carboy will be rinsed with methylene chloride, then de-ionized water, then 2N nitric acid, then again with de-ionized water. Glass carboys will be cleaned after each sample run before they are returned to the Field PM for reuse in the field.

9.3.3. Water Sampling Procedures

During each storm event, stormwater will be collected in six, five-gallon glass carboys. To fill the carboys, the Field PM will create a backwater condition in the gutter before the drain inlet at each site and use a peristaltic pump to pump the water into glass carboys. Field personnel will wear nitrile gloves during sample collection to prevent contamination. Carboys will be stored and transported in coolers with either wet ice or blue ice, and will be delivered to OWP within 24 hours of collection.

9.3.4. Hydraulic Testing

Based on the literature review and availability, the best five biochars will be mixed with the standard BSM to create biochar amended BSMs. Initially, each biochar will be mixed with standard BSM at a rate of 25% biochar by volume (the same as that at the CW4CB Richmond PG&E Substation 1st and Cutting

site). Hydraulic conductivity can be determined using the method stated in the BASMAA soil specification, method ASTM D2434.

1. Follow the directions for permeability testing in ASTM D2434 for the BSM.
2. Sieve enough of the sample biochar to collect at least 15 in³ on a no. 200 sieve.
3. Mix the sieved biochar with standard BSM at a 1 to 4 ratio.
4. Thoroughly mix the soil.
5. Follow the directions for permeability testing in ASTM D2434.
6. If the soil mix is more than 1 in/hr different from the BSM, repeat steps 1-4 but on step 3, adjust the ratio as estimated to achieve the same permeability as the BSM.
7. Repeat steps 2-6 for each biochar.

9.3.5. Column Testing Procedures

Column Setup: Up to five biochar amended BSMs and one standard BSM will be tested (based on performance and availability of biochars). Six glass columns with a diameter of eight inches and a height of three feet will be mounted to the wall with sufficient height between the bottom of the columns and the floor to allow for effluent sample collection. Each column will be capped at the bottom and fitted with a spigot to facilitate sampling. Soil depth for all columns will be 18” after compaction, which is a standard depth used in bay area bioretention installations (see Figure 9-1 below). To retain soil the bottom of the soil layer will be contained by a layer of filter fabric on top of structural backing. Behind each column, a yardstick will be mounted to the wall so that the depth of water in the column can be monitored.

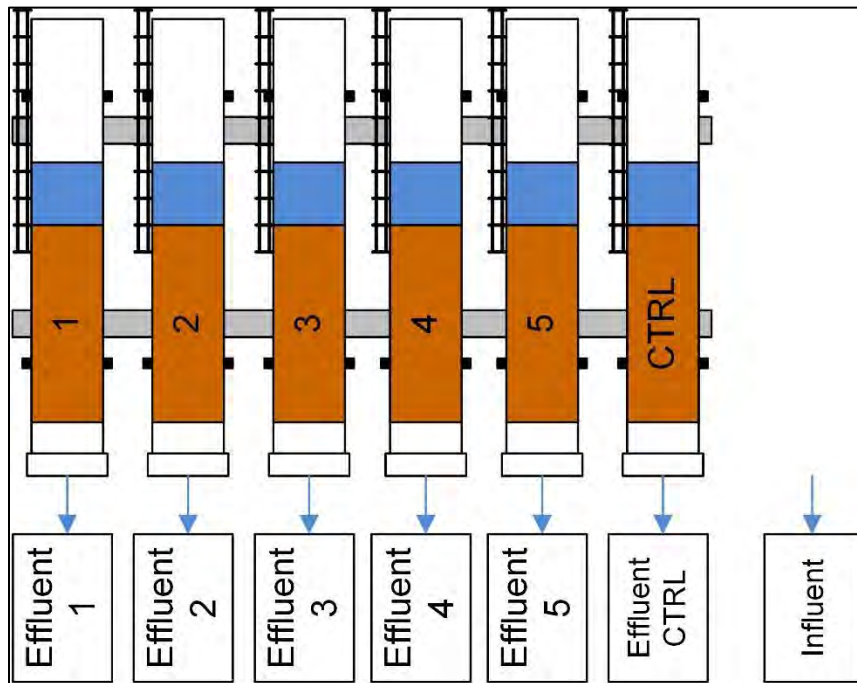

Figure 9-1. Column Test Setup

Dilution Run Column Setup: One of the existing biochar-amended BSM column and the standard BSM will be tested using diluted stormwater.

Testing procedure pre run setup: Before a sampling run begins a clean glass carboy will be placed under each soil column and labeled to match, this carboy will be sized to collect the full effluent volume

of the sample run. A glass beaker will also be assigned and labeled for each column of sufficient volume to accurately measure a single influent dose equivalent to 1 inch of depth in the column. An additional beaker will be prepared and labeled influent.

Media conditioning: Within 24 to 72 hours prior to the first column test run, pre-wet each column with a stormwater matrix collected from the CSUS campus by filling each column from the invert until water ponds above the media. Drain the water after 3 hours.

Sampling run: When the six glass carboys are delivered:

1. Inspect each carboy and fill out the Sample Receiving worksheet.
2. The runs will begin within 72 hours of delivery.
3. Select one carboy at random and fully mix it using a portable lab mixer for five minutes.
4. Turn off and remove the mixer, allow the sample to rest for one minute to allow the largest particles to settle to the bottom.
5. Fill each of the six dosing beakers and the one influent sample jar.
6. Pour each aliquot beaker into its respective column; record the time and height of water in each column.
7. Repeat steps 3-6 for each of the remaining carboys until a total of 18 inches of water is applied to each column. Before pouring an aliquot record the height of water in each column and the time. Pour each successive aliquot from the carboy when all columns have less than three inches of water above the soil surface. The water level should never be above 6 inches in any column at any time (6 inches is a standard ponding depth used in the bay area). Pour all aliquots from a single carboy into the columns at the same time.
8. Collect turbidity samples from the effluent of each column at the beginning, middle, and end of the sampling run. Fill the cuvettes for turbidity measurement directly from the effluent stream of each column and dispose of them after testing.
9. Collect mercury samples from the effluent of each column at the middle of the sample run using pre-labeled sample containers provided by the lab for that purpose.
10. Fill a pre-labeled sample jar from each columns effluent. The jar will be obtained from the laboratory performing the PCB analysis.
11. Pack each jar in ice and complete the lab COCs.
12. Ship the samples to the lab for analysis.

9.3.6. Sample ID Designations

Every sample must have a unique sample identification to ensure analytical results from each sample can be differentiated from every other sample. This information should follow the sample through the COC, analytical, and interpretation and reporting processes. Each influent and effluent water quality sample will be labeled according to the following naming convention:

SSS-TT-MMDDYYYY-##

Where:

SSS	Station code (see Table 9-2 for station codes)
TT	Sample Type (IN=influent; EF=Effluent)
MM	2 digit month of collection
DD	2 digit date of collection
YYYY	4 digit year of collection
##	Sequential 2-digit sample number (i.e., 01, 02, 03...etc.)

For example, a sample collected at the West Oakland Tree Well #2 site on October 20, 2017 and used for the influent sample for run #3 could be assigned the following sample ID: TW2-IN-09202017-03.

Table 9-2 Station Codes for Stormwater Influent Samples and Column Tests.

Station Code	Station Description
TW2	Stormwater sample collected from the West Oakland Tree Well #2
TW6	Stormwater sample collected from the West Oakland Tree Well #6
CO1	Effluent sample collected from column number 1
CO2	Effluent sample collected from column number 2
CO3	Effluent sample collected from column number 3
CO4	Effluent sample collected from column number 4
CO5	Effluent sample collected from column number 5
CO6	Effluent sample collected from column number 6

9.4. Collection of Samples for Archiving

Archive samples will not be collected for this Monitoring Program. The sample size collected will be enough to support additional analyses if QA/QC issues arise. Once quality assurance is certified by the QA Officer, the laboratory will be instructed to dispose of any leftover sample materials.

9.5. Waste Disposal

Proper disposal of all waste is an important component of field activities. At no time will any waste be disposed of improperly. The proper methods of waste disposal are outlined below:

9.5.1. Routine Garbage

Regular garbage (paper towels, paper cups, etc.) is collected by sampling personnel in garbage bags or similar. It can then be disposed of properly at appropriate intervals.

9.5.2. Detergent Washes

Any detergents used or detergent wash water should be collected in the field in a water-tight container and disposed of appropriately.

9.5.3. Chemicals

Methanol, if used, should be disposed of by following all appropriate regulations. It should always be collected when sampling and never be disposed in the field.

9.1. Responsibility and Corrective Actions

If monitoring equipment fails, sampling personnel will report the problem in the comments section of their field notes and will not record data values for the variables in question. Actions will be taken to replace or repair broken equipment prior to the next field use.

9.2. Standard Operating Procedures

SOPs associated with sampling and sample handling expected to be used as part of implementation of The Monitoring Program are identified in Table 9-3. Additional details on sample container information, required preservation, holding times, and sample volumes for all Monitoring Program analytes are listed

in Table 10-1 of Section 10.

Table 9-3. List of BASMAA RMC SOPs Utilized by the Monitoring Program.

RMC SOP #	RMC SOP	Source
FS-2	Water Quality Sampling for Chemical Analysis, Pathogen Indicators, and Toxicity	BASMAA 2016
FS-3	Field Measurements, Manual	BASMAA 2016
FS-4	Field Measurements, Continuous General Water Quality	BASMAA 2016
FS-5	Temperature, Automated, Digital Logger	BASMAA 2016
FS-6	Collection of Bedded Sediment Samples for Chemical Analysis and Toxicity	BASMAA 2016
FS-7	Field Equipment Cleaning Procedures	BASMAA 2016
FS-8	Field Equipment Decontamination Procedures	BASMAA 2016
FS-9	Sample Container, Handling, and Chain of Custody Procedures	BASMAA 2016
FS-10	Completion and Processing of Field Datasheets	BASMAA 2016
FS-11	Site and Sample Naming Convention	BASMAA 2016

In addition, contractor-specific plans and procedures may be required for specific aspects of the Monitoring Program implementation (e.g., health and safety plans, dry ice shipping procedures).

10. Sample Handling and Custody

Sample handling and chain of custody procedures are described in detail in RMC SOP FS-9 (Table 9-3) (BASMAA 2016). The Field-PM or designated municipal staff on site during sample collection will be responsible for overall collection and custody of samples during field sampling. Field crews will keep a field log, which will consist of sampling forms for each sampling event. Sample collection methods described in this document and the study designs (BASMAA 2017a, b) will be followed for each sampling task. Field data sheets will be filled out for each sample collected during the project. Example field data sheets are provided in Appendix A, and described further in Section 9.

The field crews will have custody of samples during field sampling, and COC forms will accompany all samples from field collection until delivery to the analyzing laboratory. COC procedures require that possession of samples be traceable from the time the samples are collected until completion and submittal of analytical results. Each laboratory will follow sample custody procedures as outlined in its QA plans.

Information on sampling containers, preservation techniques, packaging and shipping, and hold times is described below and summarized in Table 10.1.

10.1. Sampling Containers

Collection of all sample types require the use of clean containers. Factory pre-cleaned sample containers of the appropriate type will be provided by the contracted laboratory and delivered to field team at least one week prior to the start of sample collection. Individual laboratories will be responsible for the integrity of containers provided. The number and type of sample containers required for all analytes by media type for each sampling task are provided in Table 10.1.

10.2. Sample Preservation

Field Crews will collect samples in the field in a way that neither contaminates, loses, or changes the chemical form of the analytes of interest. The samples will be collected in the field into pre-cleaned sample containers of a material appropriate to the analysis to be conducted. Pre-cleaned sampling equipment is used for each site, whenever possible and/or when necessary. Appropriate sampling technique and measurement equipment may vary depending on the location, sample type, sampling objective, and weather.

In general, all samples will be packed in sufficient wet ice or frozen ice packs during shipment, so that they will be kept between 2 and 4° C (Table 10.1). When used, wet ice will be double bagged in Zip-top bags to prevent contamination via melt water. Where appropriate, samples may be frozen to prevent degradation. If samples are to be shipped frozen on dry ice, then appropriate handling procedures will be followed, including ensuring use of appropriate packaging materials and appropriate training for shipping personnel.

10.3. Packaging and Shipping

All samples will be handled, prepared, transported, and stored in a manner so as to minimize bulk loss, analyte loss, contamination, or biological degradation. Sample containers will be clearly labeled with an indelible marker. All caps and lids will be checked for tightness prior to shipping. Ice chests will be sealed with packing tape before shipping. Samples will be placed in the ice chest with enough ice or frozen ice packs to maintain between 2 and 4° C. Additional packing material will be added as needed. COC forms will be placed in a zip-top bag and placed inside of the ice chest.

10.4. Commercial Vehicle Transport

If transport of samples to the contracted laboratories is to be by commercial carriers, pickup will be pre-arranged with the carrier and all required shipping forms will be completed prior to sample pickup by the commercial carrier.

10.5. Sample Hold Times

Sample hold times for each analyte by media type are presented in Table 10-1.

Table 10-1 Sample Handling for the Monitoring Program Analytes by media type.

Analyte	Sample Media	Sample Container	Minimum Sample / Container Size ^a	Preservative	Hold Time (at 6° C)
PCBs (40-RMP Congeners)	Caulk or sealant	Pre-cleaned 250-mL glass sample container (e.g., Quality Certified™, ESS Vial, Oakland, CA)	10 g	Cool to 6° C within 24 hours, then freeze to ≤-20° C	1 year at -20° C; Samples must be analyzed within 14 days of collection or thawing.
	Sediment	Pre-cleaned 250-mL I-Chem 200 Series amber glass jar with Teflon lid liner	500 mL (two jars)	Cool to 6° C within 24 hours, then freeze to ≤-20° C	1 year at -20° C; Samples must be analyzed within 14 days of collection or thawing.
	Water	1000-mL I-Chem 200-Series amber glass bottle, with Teflon lid-liner	1000 mL/per individual analyses	Cool to 6° C in the dark.	1 year until extraction, 1 year after extraction
Total Mercury	Sediment	Pre-cleaned 250-mL I-Chem 200 Series amber glass jar with Teflon lid liner	100 g	Cool to 6° C and in the dark	1 year at -20° C; Samples must be analyzed within 14 days of collection or thawing.
	Water	250-mL glass or acid-cleaned Teflon bottle	250 mL	Cool to 6° C in the dark and acidify to 0.5% with pre-tested HCl within 48 hours	6 months at room temperature following acidification
Bulk Density	Sediment	250-mL clear glass jar; pre-cleaned	250 mL	Cool to 6° C	7 days
Grain Size and TOC	Sediment	250-mL clear glass jar; pre-cleaned	250 mL	Cool to 6° C, in the dark up to 28 days ²	28 days at ≤6 °C; 1 year at ≤-20 °C
SSC	Water	125-mL amber glass jar or Polyethylene Bottles	125 mL	Cool to 6° C and store in the dark	7 days
Turbidity	Water				
Total Solids	Water	1 L HDPE	1 L	Cool to ≤6 °C	7 days
TOC	Water	40-mL glass vial	40 mL	Cool to 6° C and store in the dark. If analysis is to occur more than two hours after sampling, acidify (pH < 2) with HCl or H ₂ SO ₄ .	28 days
Particle Size Distribution	Water	1 L HDPE	2 L	Cool to 6° C and store in the dark	7 days

^aQC samples or other analytes require additional sample bottles.

11. Field Health and Safety Procedures

All field crews will be expected to abide by their employer's (i.e., the field contractor's) health and safety programs. Additionally, prior to the fieldwork, field contractors are required to develop site-specific Health and Safety plans that include the locations of the nearest emergency medical services.

Implementation of the Monitoring Program activities may require confined space entry (CSE) to accomplish sampling goals. Sampling personnel conducting any confined space entry activities will be expected to be certified for CSE and to abide by relevant regulations.

12. Laboratory Analytical Methods

12.1. Caulk/Sealant Samples (Task 1)

12.1.1. XRF Chlorine analysis

XRF technology will be used in a laboratory setting to rank samples for chlorine content before sending the samples to the project laboratory for chemical analysis. Procedures for testing caulk or sealants using X-Ray fluorescence (XRF) and collecting caulk and sealant samples are not well described, and minimal detail on caulk or sealant sample collection is available in peer-reviewed publications. Sealant sampling procedures were adapted from the previous study examining PCBs in building materials (Klosterhaus et al., 2014).

An XRF analyzer will be used at the Center for Environmental Health (CEH) as a screening tool to estimate the concentration of chlorine (Cl) in collected caulk and sealant samples from various structures. Settings for the analyzer will be 'standardized' using procedures developed/ recommended by CEH each time the instrument is turned on and prior to any measurement. European plastic pellet reference materials (EC680 and EC681) will be used as 'check' standards upon first use to verify analyzer performance. A 30 second measurement in 'soil' mode will be used. CEH personnel will inspect the caulk/sealant surfaces and use a stainless steel blade to scrape off any paint, concrete chips, or other visible surface residue. The caulk/sealant surface to be sampled will then be wiped with a laboratory tissue to remove any remaining debris that may potentially interfere with the XRF analysis. At least two XRF readings will be collected from each sample switching the orientation or position of the sample between readings. If Cl is detected, a minimum of four additional readings will be collected on the same material to determine analytical variability. Each individual Cl reading and its detection limit will be recorded on the data sheet. After XRF analysis, all samples will be returned to their original sample container. Results of the XRF analysis will be provided to the project team as a table of ranked Cl screening results for possible selection for chemical (PCBs) analysis.

12.1.2. Selection of Samples for PCB analysis and Compositing

Once samples have been ranked for their chlorine content, primarily samples with the highest Cl will preferentially be selected for chemical analysis. About 75% of samples to be analyzed should be selected from samples with the top quartile Cl content. The remaining 25% should be selected from samples with medium (25 to 75th percentile) Cl, as the previous study using XRF screening showed inconsistent correlation between total Cl and PCB. Although samples with very low Cl seldom had much PCBs, samples with medium Cl on occasion had higher PCBs than samples with high Cl, and within the high Cl group, Cl content was not a good predictor of their ranks of PCB concentration.

In addition to Cl content, other factors about each sample that were recorded on the field data sheets at the time of sample collection, including the color or consistency of the sample, the type and/or age of the structure that was sampled, or the type of caulk or sealant application will be considered in selecting the samples that will be sent to the laboratory for PCBs analysis, as well as how the samples will be grouped for compositing purposes. Those factors are described in more detail in the study design (BASMAA, 2017a).

The Consultant PM will work with the project team to identify up to three samples for inclusion in each composite. A common composite ID will then be assigned to each sample that will be composited together (i.e., all samples the lab should composite together will be identified by the common composite ID). The composite ID will consist of a single letter designation and will be identical for all samples (up to 3 total) that will be composited together. The Consultant PM will add the composite ID to each sample container label, to each sample ID on all COC forms, and to each field data sheet for all samples prior to sending the samples to the laboratory for PCBs analysis.

12.1.3. Sample Preparation

The project laboratory will composite the samples prior to extraction and PCBs analysis according to the groupings identified by the common composite ID. Sample preparation will include removal of any paint, concrete chips, or other surface debris, followed by homogenization of the caulk/sealant material and compositing up to three samples per composite. Each sample will have a composite ID that will be used to identify which samples should be composited together. Samples with the same composite ID will be combined into a single composite sample. For example, all samples with composite ID = “A” will be composited together; all samples with composite ID = “B” will be composited together, etc. Sample preparation and compositing will follow the procedures outlined in the laboratory SOPs (Appendix B). After compositing, each composite sample will be assigned a new sample ID using the following naming convention:

X-MMDDYYYY

Where:

- X the single letter Composite ID that is common to all samples included in a given composite.
- MM 2 digit month of composite preparation
- DD 2 digit date of composite preparation
- YYYY 4 digit year of composite preparation

For example, if three samples with the composite ID= “A” are combined into a single composite sample on December 12, 2017, the new (composite) sample ID would be the following: A-12122017.

12.1.4. PCBs Analysis

All composite caulk/sealant samples will be extracted by Method 3540C, and analyzed for the RMP-40 PCB congeners³ using a modified EPA Method 8270C (GC/MS-SIM), in order to obtain positive

³ The 40 individual congeners routinely quantified by the Regional Monitoring Program (RMP) for Water Quality in the San Francisco Estuary include: PCBs 8, 18, 28, 31, 33, 44, 49, 52, 56, 60, 66, 70, 74, 87, 95, 97, 99, 101, 105, 110, 118, 128, 132, 138, 141, 149, 151, 153, 156, 158, 170, 174, 177, 180, 183, 187, 194, 195, 201, and 203

identification and quantitation of PCBs. PCB content of these material covers an extremely wide range, so the subsampling of material should include sufficient material for quantification assuming that the concentration is likely to be around the median of previous results. There may be samples with much higher concentrations, which can be reanalyzed on dilution as needed. Method Reporting Limits (MRLs) for each of the RMP-40 PCB Congeners are 0.5 µg/Kg.

12.2. Sediment Samples Collected from HDS Units (Task 2)

All sediment samples collected from HDS units under Task 2 will be analyzed for TOC, grain size, bulk density, total mercury, and PCBs (RMP 40 Congeners) by the methods identified in Table 12-1. All sediment samples (with the exception of grain size) will be sieved by the laboratory at 2 mm prior to analysis.

Table 12-1. Laboratory Analytical Methods for Analytes in Sediment

Analyte	Sampling Method	Recommended Analytical Method	Reporting Units
Total Organic Carbon (TOC)	Grab	EPA 415.1, 440.0, 9060, or ASTM D4129M	%
Grain Size	Grab	ASTM D422M/PSEP	%
Bulk Density	Grab	ASTM E1109-86	g/cm ³
Mercury	Grab	EPA 7471A, 7473, or 1631	µg/kg
PCBs (RMP 40 Congeners)	Grab	EPA 1668	µg/kg

12.3. Water Samples – Stormwater and Column Tests (Task 3)

All water samples submitted to the laboratory will be analyzed for SSC, TOC, total mercury and PCBs (RMP-40 congeners) according to the methods identified in Table 12-2.

Table 12-2. Laboratory Analytical Methods for Analytes in Water

Analyte	Sampling Method	Recommended Analytical Method	Reporting Units
Suspended Sediment Concentration (SSC)	Grab	ASTM D3977-97 (Method C)	mg/L
Total Organic Carbon (TOC)	Grab	EPA 415.1 or SM 5310B	%
Mercury (Total)	Grab	EPA 1631	µg/L
PCBs (RMP 40 Congeners)	Grab	EPA 1668	ng/L

12.4. Method Failures

The QA Officer will be responsible for overseeing the laboratory implementing any corrective actions that may be needed in the event that methods fail to produce acceptable data. If a method fails to provide acceptable data for any reason, including analyte or matrix interferences, instrument failures, etc., then the involved samples will be analyzed again if possible. The laboratory in question's SOP for handling these types of problems will be followed. When a method fails to provide acceptable data, then the laboratory's

SOP for documenting method failures will be used to document the problem and what was done to rectify it.

Corrective actions for chemical data are taken when an analysis is deemed suspect for some reason. These reasons include exceeding accuracy or precision ranges and/or problems with sorting and identification. The corrective action will vary on a case-by-case basis, but at a minimum involves the following:

- A check of procedures.
- A review of documents and calculations to identify possible errors.
- Correction of errors based on discussions among analysts.
- A complete re-identification of the sample.

The field and laboratory coordinators shall have systems in place to document problems and make corrective actions. All corrective actions will be documented to the FTL and the QA Officer.

12.5. Sample Disposal

After analysis of the Monitoring Program samples has been completed by the laboratory and results have been accepted by QA Officer and the Field-PM, they will be disposed by laboratory staff in compliance with all federal, state, and local regulations. The laboratory has standard procedures for disposing of its waste, including left over sample materials

12.6. Laboratory Sample Processing

Field samples sent to the laboratories will be processed within their recommended hold time using methods agreed upon method between the Lab-PM and Field-PM. Each sample may be assigned unique laboratory sample ID numbers for tracking processing and analyses of samples within the laboratory. This laboratory sample ID (if differing from the field team sample ID) must be included in the data submission, within a lookup table linking the field sample ID to that assigned by the lab.

Samples arriving at the laboratory are to be stored under conditions appropriate for the planned analytical procedure(s), unless they are processed for analysis immediately upon receipt. Samples to be analyzed should only be removed from storage when laboratory staff are ready to proceed.

13. Quality Control

Each step in the field collection and analytical process is a potential source of contamination and must be consistently monitored to ensure that the final measurement is not adversely affected by any processing steps. Various aspects of the quality control procedures required by the Monitoring Program are summarized below.

13.1. Field Quality Control

Field QC results must meet the MQOs and frequency requirements specified in Tables 13-1 – 13-4 below.

13.1.1. Field Blanks

A field blank is collected to assess potential sample contamination levels that occur during field sampling activities. Field blanks are taken to the field, transferred to the appropriate container, preserved (if required by the method), and treated the same as the corresponding sample type during the course of a sampling event. The inclusion of field blanks is dependent on the requirements specified in the relevant MQO tables or in the sampling method or SOP.

Collection of caulk or sealant field blank samples has been deemed unnecessary due to the difficulty in collection and interpretation of representative blank samples and the use of precautions that minimize contamination of the samples. Additionally, PCBs have been reported to be present in percent concentrations when used in sealants; therefore any low level contamination (at ppb or even ppm level) due to sampling equipment and procedures is not expected to affect data quality because it would be many orders of magnitude lower than the concentrations deemed to be a positive PCB signal.

For stormwater samples, field blanks will be generated using lab supplied containers and clean matrices. Sampling containers will be opened as though actual samples were to be collected, and clean lab-supplied matrix (if any) will be transferred to sample containers for analysis.

13.1.2. Field Duplicates

Field samples collected in duplicate provide precision information as it pertains to the sampling process. The duplicate sample must be collected in the same manner and as close in time as possible to the original sample. This effort is to attempt to examine field homogeneity as well as sample handling, within the limits and constraints of the situation. These data are evaluated in the data analysis/assessment process for small-scale spatial variability.

Field duplicates will not be collected for caulk/sealant samples (Task 1), as assessment of within-structure variability of PCB concentrations in sealants is not a primary objective of the Project. Due to budget limitations, PCBs analysis of only one caulk/sealant sample per application will be targeted to maximize the number of Bay Area structures and structure types that may be analyzed in the Project. The selected laboratory will conduct a number of quality assurance analyses (see Section 13), including a limited number of sample duplicates, to evaluate laboratory and method performance as well as variability of PCB content within a sample.

For all sediment and water samples, 5% of field duplicates and/or column influent/effluent duplicates will be collected along with primary samples in order to evaluate small scale spatial or temporal variability in sample collection without specifically targeting any apparent or likely bias (e.g. different sides of a seemingly symmetrical unit, or offset locations in making a composite, or immediately following collection of a primary water sample would be acceptable, whereas collecting one composite near an inlet and another near the outlet, or intentionally collecting times with vastly different flow rates, would not be desirable).

13.1.3. Field Corrective Action

The Field PM is responsible for responding to failures in their sampling and field measurement systems. If monitoring equipment fails, personnel are to record the problem according to their documentation protocols. Failing equipment must be replaced or repaired prior to subsequent sampling events. It is the combined responsibility of all members of the field organization to determine if the performance

requirements of the specific sampling method have been met, and to collect additional samples if necessary. Associated data is to be flagged accordingly. Specific field corrective actions are detailed in Table 13-8.

13.2. Laboratory Quality Control

Laboratories providing analytical support to the Monitoring Program will have the appropriate facilities to store, prepare, and process samples in an ultra-clean environment, and will have appropriate instrumentation and staff to perform analyses and provide data of the required quality within the time period dictated by the Monitoring Program. The laboratories are expected to satisfy the following:

1. Demonstrate capability through pertinent certification and satisfactory performance in inter-laboratory comparison exercises.
2. Provide qualification statements regarding their facility and personnel.
3. Maintain a program of scheduled maintenance of analytical balances, laboratory equipment and instrumentation.
4. Conduct routine checking of analytical balances using a set of standard reference weights (American Society of Testing and Materials Class 3, NIST Class S-1, or equivalents). Analytical balances are serviced at six-month intervals or when test weight values are not within the manufacturer's instrument specifications, whichever occurs first.
5. Conduct routine checking and recording the composition of fresh calibration standards against the previous lot. Acceptable comparisons are within 2% of the precious value.
6. Record all analytical data in bound (where possible) logbooks, with all entries in ink, or electronically.
7. Monitor and document the temperatures of cold storage areas and freezer units on a continuous basis.
8. Verify the efficiency of fume/exhaust hoods.
9. Have a source of reagent water meeting specifications described in Section 8.0 available in sufficient quantity to support analytical operations.
10. Label all containers used in the laboratory with date prepared, contents, initials of the individual who prepared the contents, and other information as appropriate.
11. Date and safely store all chemicals upon receipt. Proper disposal of chemicals when the expiration date has passed.
12. Have QAPP, SOPs, analytical methods manuals, and safety plans readily available to staff.
13. Have raw analytical data readily accessible so that they are available upon request.

In addition, laboratories involved in the Monitoring Program are required to demonstrate capability continuously through the following protocols:

1. Strict adherence to routine QA/QC procedures.
2. Regular participation in annual certification programs.
3. Satisfactory performance at least annually in the analysis of blind Performance Evaluation Samples and/or participation in inter-laboratory comparison exercises.

Laboratory QC samples must satisfy MQOs and frequency requirements. MQOs and frequency requirements are listed in Tables 13-1 – 13-3. Frequency requirements are provided on an analytical batch

level. The Monitoring Program defines an analytical batch as 20 or fewer samples and associated quality control that are processed by the same instrument within a 24-hour period (unless otherwise specified by method). Target Method Reporting Limits are provided in Tables 13.4 – 13.8. Details regarding sample preparation are method- or laboratory SOP-specific, and may consist of extraction, digestion, or other techniques.

13.2.1. Calibration and Working Standards

All calibration standards must be traceable to a certified standard obtained from a recognized organization. If traceable standards are not available, procedures must be implemented to standardize the utilized calibration solutions (*e.g.*, comparison to a CRM – see below). Standardization of calibration solutions must be thoroughly documented, and is only acceptable when pre-certified standard solutions are not available. Working standards are dilutions of stock standards prepared for daily use in the laboratory. Working standards are used to calibrate instruments or prepare matrix spikes, and may be prepared at several different dilutions from a common stock standard. Working standards are diluted with solutions that ensure the stability of the target analyte. Preparation of the working standard must be thoroughly documented such that each working standard is traceable back to its original stock standard. Finally, the concentration of all working standards must be verified by analysis prior to use in the laboratory.

13.2.2. Instrument Calibration

Prior to sample analysis, utilized instruments must be calibrated following the procedures outlined in the relevant analytical method or laboratory SOP. Each method or SOP must specify acceptance criteria that demonstrate instrument stability and an acceptable calibration. If instrument calibration does not meet the specified acceptance criteria, the analytical process is not in control and must be halted. The instrument must be successfully recalibrated before samples may be analyzed.

Calibration curves will be established for each analyte covering the range of expected sample concentrations. Only data that result from quantification within the demonstrated working calibration range may be reported unflagged by the laboratory. Quantification based upon extrapolation is not acceptable; sample extracts above the calibration range should be diluted and rerun if possible. Data reported below the calibration range must be flagged as estimated values that are Detected not Quantified.

13.2.3. Initial Calibration Verification

The initial calibration verification (ICV) is a mid-level standard analyzed immediately following the calibration curve. The source of the standards used to calibrate the instrument and the source of the standard used to perform the ICV must be independent of one another. This is usually achieved by the purchase of standards from separate vendors. Since the standards are obtained from independent sources and both are traceable, analyses of the ICV functions as a check on the accuracy of the standards used to calibrate the instrument. The ICV is not a requirement of all SOPs or methods, particularly if other checks on analytical accuracy are present in the sample batch.

13.2.4. Continuing Calibration Verification

Continuing calibration verification (CCV) standards are mid-level standards analyzed at specified intervals during the course of the analytical run. CCVs are used to monitor sensitivity changes in the instrument during analysis. In order to properly assess these sensitivity changes, the standards used to perform CCVs must be from the same set of working standards used to calibrate the instrument. Use of a

second source standard is not necessary for CCV standards, since other QC samples are designed to assess the accuracy of the calibration standards. Analysis of CCVs using the calibration standards limits this QC sample to assessing only instrument sensitivity changes. The acceptance criteria and required frequency for CCVs are detailed in Tables 13-1 through 13-3. If a CCV falls outside the acceptance limits, the analytical system is not in control, and immediate corrective action must be taken.

Data obtained while the instrument is out of control is not reportable, and all samples analyzed during this period must be reanalyzed. If reanalysis is not an option, the original data must be flagged with the appropriate qualifier and reported. A narrative must be submitted listing the results that were generated while the instrument was out of control, in addition to corrective actions that were applied.

13.2.5. Laboratory Blanks

Laboratory blanks (also called extraction blanks, procedural blanks, or method blanks) are used to assess the background level of a target analyte resulting from sample preparation and analysis. Laboratory blanks are carried through precisely the same procedures as the field samples. For both organic and inorganic analyses, a minimum of at least one laboratory blank must be prepared and analyzed in every analytical batch or per 20 samples, whichever is more frequent. Some methods may require more than one laboratory blank with each analytical run. Acceptance criteria for laboratory blanks are detailed in Tables 13-1 through 13-3. Blanks that are too high require corrective action to bring the concentrations down to acceptable levels. This may involve changing reagents, cleaning equipment, or even modifying the utilized methods or SOPs. Although acceptable laboratory blanks are important for obtaining results for low-level samples, improvements in analytical sensitivity have pushed detection limits down to the point where some amount of analyte will be detected in even the cleanest laboratory blanks. The magnitude of the blanks must be evaluated against the concentrations of the samples being analyzed and against project objectives.

13.2.6. Reference Materials and Demonstration of Laboratory Accuracy

Evaluation of the accuracy of laboratory procedures is achieved through the preparation and analysis of reference materials with each analytical batch. Ideally, the reference materials selected are similar in matrix and concentration range to the samples being prepared and analyzed. The acceptance criteria for reference materials are listed in Tables 13-1 – 13-3. The accuracy of an analytical method can be assessed using CRMs only when certified values are provided for the target analytes. When possible, reference materials that have certified values for the target analytes should be used. This is not always possible, and often times certified reference values are not available for all target analytes. Many reference materials have both certified and non-certified (or reference) values listed on the certificate of analysis. Certified reference values are clearly distinguished from the non-certified reference values on the certificate of analysis.

13.2.7. Reference Materials vs. Certified Reference Materials

The distinction between a reference material and a certified reference material does not involve how the two are prepared, rather with the way that the reference values were established. Certified values are determined through replicate analyses using two independent measurement techniques for verification. The certifying agency may also provide “non-certified or “reference” values for other target analytes. Such values are determined using a single measurement technique that may introduce bias. When available, it is preferable to use reference materials that have certified values for all target analytes. This is not always an option, and therefore it is acceptable to use materials that have reference values for these

analytes. Note: Standard Reference Materials (SRMs) are essentially the same as CRMs. The term “Standard Reference Material” has been trademarked by the National Institute of Standards and Technology (NIST), and is therefore used only for reference materials distributed by NIST.

13.2.8. Laboratory Control Samples

While reference materials are not available for all analytes, a way of assessing the accuracy of an analytical method is still required. LCSs provide an alternate method of assessing accuracy. An LCS is a specimen of known composition prepared using contaminant-free reagent water or an inert solid spiked with the target analyte at the midpoint of the calibration curve or at the level of concern. The LCS must be analyzed using the same preparation, reagents, and analytical methods employed for regular samples. If an LCS needs to be substituted for a reference material, the acceptance criteria are the same as those for the analysis of reference materials..

13.2.9. Prioritizing Certified Reference Materials, Reference Materials, and Laboratory Control Samples

Certified reference materials, reference materials, and laboratory control samples all provide a method to assess the accuracy at the mid-range of the analytical process. However, this does not mean that they can be used interchangeably in all situations. When available, analysis of one certified reference material per analytical batch should be conducted. Certified values are not always available for all target analytes. If no certified reference material exists, reference values may be used. If no reference material exists for the target analyte, an LCS must be prepared and analyzed with the sample batch as a means of assessing accuracy. The hierarchy is as follows: analysis of a CRM is favored over the analysis of a reference material, and analysis of a reference material is preferable to the analysis of an LCS. Substitution of an LCS is not acceptable if a certified reference material or reference material is available, contact the Project Manager and QAO for approval before relying exclusively on an LCS as a measure of accuracy.

13.2.10. Matrix Spikes

A MS is prepared by adding a known concentration of the target analyte to a field sample, which is then subjected to the entire analytical procedure. The MS is analyzed in order to assess the magnitude of matrix interference and bias present. Because these spikes are often analyzed in pairs, the second spike is called the MSD. The MSD provides information regarding the precision of measurement and consistency of the matrix effects. Both the MS and MSD are split from the same original field sample. In order to properly assess the degree of matrix interference and potential bias, the spiking level should be approximately 2-5x the ambient concentration of the spiked sample. To establish spiking levels prior to sample analysis, if possible, laboratories should review any relevant historical data. In many instances, the laboratory will be spiking samples blind and will not meet a spiking level of 2-5x the ambient concentration. In addition to the recoveries, the relative percent difference (RPD) between the MS and MSD is calculated to evaluate how matrix affects precision. The MQO for the RPD between the MS and MSD is the same regardless of the method of calculation. These are detailed in Tables 13-1 – 13-3. Recovery data for matrix spikes provides a basis for determining the prevalence of matrix effects in the samples collected and analyzed. If the percent recovery for any analyte in the MS or MSD is outside of the limits specified in Tables 13-1 – 13-3, the chromatograms (in the case of trace organic analyses) and raw data quantitation reports should be reviewed. Data should be scrutinized for evidence of sensitivity shifts (indicated by the results of the CCVs) or other potential problems with the analytical process. If associated QC samples (reference materials or LCSs) are in control, matrix effects may be the source of

the problem. If the standard used to spike the samples is different from the standard used to calibrate the instrument, it must be checked for accuracy prior to attributing poor recoveries to matrix effects.

13.2.11.Laboratory Duplicates

In order to evaluate the precision of an analytical process, a field sample is selected and prepared in duplicate. Specific requirements pertaining to the analysis of laboratory duplicates vary depending on the type of analysis. The acceptance criteria for laboratory duplicates are specified in Tables 13-1 – 13-3.

13.2.12.Laboratory Duplicates vs. Matrix Spike Duplicates

Although the laboratory duplicate and matrix spike duplicate both provide information regarding precision, they are unique measurements. Laboratory duplicates provide information regarding the precision of laboratory procedures at actual ambient concentrations. The matrix spike duplicate provides information regarding how the matrix of the sample affects both the precision and bias associated with the results. It also determines whether or not the matrix affects the results in a reproducible manner. MS/MSDs are often spiked at levels well above ambient concentrations, so thus are not representative of typical sample precision. Because the two concepts cannot be used interchangeably, it is unacceptable to analyze only an MS/MSD when a laboratory duplicate is required.

13.2.13.Replicate Analyses

The Monitoring Program will adopt the same terminology as SWAMP in defining replicate samples, wherein replicate analyses are distinguished from duplicate analyses based simply on the number of involved analyses. Duplicate analyses refer to two sample preparations, while replicate analyses refer to three or more. Analysis of replicate samples is not explicitly required.

13.2.14.Surrogates

Surrogate compounds accompany organic measurements in order to estimate target analyte losses or matrix effects during sample extraction and analysis. The selected surrogate compounds behave similarly to the target analytes, and therefore any loss of the surrogate compound during preparation and analysis is presumed to coincide with a similar loss of the target analyte. Surrogate compounds must be added to field and QC samples prior to extraction, or according to the utilized method or SOP. Surrogate recovery data are to be carefully monitored. If possible, isotopically labeled analogs of the analytes are to be used as surrogates.

13.2.15.Internal Standards

To optimize gas chromatography mass spectrometry (GC-MS) analysis, internal standards (also referred to as “injection internal standards”) may be added to field and QC sample extracts prior to injection. Use of internal standards is particularly important for analysis of complex extracts subject to retention time shifts relative to the analysis of standards. The internal standards can also be used to detect and correct for problems in the GC injection port or other parts of the instrument. The analyst must monitor internal standard retention times and recoveries to determine if instrument maintenance or repair or changes in analytical procedures are indicated. Corrective action is initiated based on the judgment of the analyst. Instrument problems that affect the data or result in reanalysis must be documented properly in logbooks and internal data reports, and used by the laboratory personnel to take appropriate corrective action. Performance criteria for internal standards are established by the method or laboratory SOP.

13.2.16. Dual-Column Confirmation

Due to the high probability of false positives from single-column analyses, dual column confirmation should be applied to all gas chromatography and liquid chromatography methods that do not provide definitive identifications. It should not be restricted to instruments with electron capture detection (ECD).

13.2.17. Dilution of Samples

Final reported results must be corrected for dilution carried out during the process of analysis. In order to evaluate the QC analyses associated with an analytical batch, corresponding batch QC samples must be analyzed at the same dilution factor. For example, the results used to calculate the results of matrix spikes must be derived from results for the native sample, matrix spike, and matrix spike duplicate analyzed at the same dilution. Results derived from samples analyzed at different dilution factors must not be used to calculate QC results.

13.2.18. Laboratory Corrective Action

Failures in laboratory measurement systems include, but are not limited to: instrument malfunction, calibration failure, sample container breakage, contamination, and QC sample failure. If the failure can be corrected, the analyst must document it and its associated corrective actions in the laboratory record and complete the analysis. If the failure is not resolved, it is conveyed to the respective supervisor who should determine if the analytical failure compromised associated results. The nature and disposition of the problem must be documented in the data report that is sent to the Consultant-PM. Suggested corrective actions are detailed in Table 13-9.

Table 13-1. Measurement Quality Objectives - PCBs.

Laboratory Quality Control	Frequency of Analysis	Measurement Quality Objective
Tuning²	Per analytical method	Per analytical method
Calibration	Initial method setup or when the calibration verification fails	<ul style="list-style-type: none"> • Correlation coefficient ($r^2 > 0.990$) for linear and non-linear curves • If $RSD < 15\%$, average RF may be used to quantitate; otherwise use equation of the curve • First- or second-order curves only (not forced through the origin) • Refer to SW-846 methods for SPCC and CCC criteria² • Minimum of 5 points per curve (one of them at or below the RL)
Calibration Verification	Per 12 hours	<ul style="list-style-type: none"> • Expected response or expected concentration $\pm 20\%$ • RF for SPCCs=initial calibration⁴
Laboratory Blank	Per 20 samples or per analytical batch, whichever is more frequent	<RL for target analytes
Reference Material	Per 20 samples or per analytical batch	70-130% recovery if certified; otherwise, 50-150% recovery
Matrix Spike	Per 20 samples or per analytical batch, whichever is more frequent	50-150% or based on historical laboratory control limits (average $\pm 3SD$)
Matrix Spike Duplicate	Per 20 samples or per analytical batch, whichever is more frequent	50-150% or based on historical laboratory control limits (average $\pm 3SD$); $RPD < 25\%$
Surrogate	Included in all samples and all QC samples	Based on historical laboratory control limits (50-150% or better)
Internal Standard	Included in all samples and all QC samples (as available)	Per laboratory procedure
Field Quality Control	Frequency of Analysis	Measurement Quality Objective
Field Duplicate	5% of total Project sample count (sediment and water samples only)	$RPD < 25\%$ (n/a if concentration of either sample < RL)
Field Blank	Not required for the Monitoring Program	<RL for target analytes

Table 13-2. Measurement Quality Objectives – Inorganic Analytes.

Laboratory Quality Control	Frequency of Analysis	Measurement Quality Objective
Calibration Standard	Per analytical method or manufacturer's specifications	Per analytical method or manufacturer's specifications
Continuing Calibration Verification	Per 10 analytical runs	80-120% recovery
Laboratory Blank	Per 20 samples or per analytical batch, whichever is more frequent	<RL for target analyte
Reference Material	Per 20 samples or per analytical batch, whichever is more frequent	75-125% recovery
Matrix Spike	Per 20 samples or per analytical batch, whichever is more frequent	75-125% recovery
Matrix Spike Duplicate	Per 20 samples or per analytical batch, whichever is more frequent	75-125% recovery ; RPD<25%
Laboratory Duplicate	Per 20 samples or per analytical batch, whichever is more frequent	RPD<25% (n/a if concentration of either sample<RL)
Internal Standard	Accompanying every analytical run when method appropriate	60-125% recovery
Field Quality Control	Frequency of Analysis	Measurement Quality Objective
Field Duplicate	5% of total Project sample count	RPD<25% (n/a if concentration of either sample<RL), unless otherwise specified by method
Field Blank, Equipment Field, Eqpt Blanks	Not required for the Monitoring Program	Blanks<RL for target analyte

Table 13-3. Measurement Quality Objectives – Conventional Analytes.

Laboratory Quality Control	Frequency of Analysis	Measurement Quality Objective
Calibration Standard	Per analytical method or manufacturer's specifications	Per analytical method or manufacturer's specifications
Laboratory Blank	Total organic carbon only: one per 20 samples or per analytical batch, whichever is more frequent (n/a for other parameters)	80-120% recovery
Reference Material	One per analytical batch	RPD<25% (n/a if native concentration of either sample<RL)
Laboratory Duplicate	(TOC only) one per 20 samples or per analytical batch, whichever is more frequent (n/a for other parameters)	80-120% recovery
Field Quality Control	Frequency of Analysis	Measurement Quality Objective
Field Duplicate	5% of total Project sample count	RPD<25% (n/a if concentration of either sample<RL)
Field Blank, Travel Blank, Field Blanks	Not required for the Monitoring Program analytes	NA

Consistent with SWAMP QAPP and as applicable, percent moisture should be reported with each batch of sediment samples. Sediment data must be reported on a dry weight basis.

Table 13-4. Target MRLs for Sediment Quality Parameters.

Analyte	MRL
Sediment Total Organic Carbon	0.01% OC
Bulk Density	n/a
%Moisture	n/a
%Lipids	n/a
Mercury	30 µg/kg

Table 13-5. Target MRLs for PCBs in Water, Sediment and Caulk

Congener	Water MRL (µg/L)	Sediment MRL (µg/kg)	Caulk/Sealant MRL (µg/kg)
PCB 8	0.002	0.2	0.5
PCB 18	0.002	0.2	0.5
PCB 28	0.002	0.2	0.5
PCB 31	0.002	0.2	0.5
PCB 33	0.002	0.2	0.5
PCB 44	0.002	0.2	0.5
PCB 49	0.002	0.2	0.5
PCB 52	0.002	0.2	0.5
PCB 56	0.002	0.2	0.5
PCB 60	0.002	0.2	0.5
PCB 66	0.002	0.2	0.5
PCB 70	0.002	0.2	0.5
PCB 74	0.002	0.2	0.5
PCB 87	0.002	0.2	0.5
PCB 95	0.002	0.2	0.5
PCB 97	0.002	0.2	0.5
PCB 99	0.002	0.2	0.5
PCB 101	0.002	0.2	0.5
PCB 105	0.002	0.2	0.5
PCB 110	0.002	0.2	0.5
PCB 118	0.002	0.2	0.5
PCB 128	0.002	0.2	0.5
PCB 132	0.002	0.2	0.5
PCB 138	0.002	0.2	0.5
PCB 141	0.002	0.2	0.5
PCB 149	0.002	0.2	0.5
PCB 151	0.002	0.2	0.5
PCB 153	0.002	0.2	0.5
PCB 156	0.002	0.2	0.5
PCB 158	0.002	0.2	0.5
PCB 170	0.002	0.2	0.5
PCB 174	0.002	0.2	0.5
PCB 177	0.002	0.2	0.5
PCB 180	0.002	0.2	0.5
PCB 183	0.002	0.2	0.5
PCB 187	0.002	0.2	0.5
PCB 194	0.002	0.2	0.5
PCB 195	0.002	0.2	0.5
PCB 201	0.002	0.2	0.5
PCB 203	0.002	0.2	0.5

Table 13-6. Size Distribution Categories for Grain Size in Sediment

Wentworth Size Category	Size	MRL
Clay	<0.0039 mm	1%
Silt	0.0039 mm to <0.0625 mm	1%
Sand, very fine	0.0625 mm to <0.125 mm	1%
Sand, fine	0.125 mm to <0.250 mm	1%
Sand, medium	0.250 mm to <0.5 mm	1%
Sand, coarse	0.5 mm to < 1.0 mm	1%
Sand, very coarse	1.0 mm to < 2 mm	1%
Gravel	2 mm and larger	1%

Table 13-7. Target MRLs for TOC, SSC, and Mercury in Water

Analyte	MRL
Total Organic Carbon	0.6 mg/L
Suspended Sediment Concentration	0.5 mg/L
Mercury	0.0002 µg/L

Table 13-8. Corrective Action – Laboratory and Field Quality Control

Laboratory Quality Control	Recommended Corrective Action
Calibration	Recalibrate the instrument. Affected samples and associated quality control must be reanalyzed following successful instrument recalibration.
Calibration Verification	Reanalyze the calibration verification to confirm the result. If the problem continues, halt analysis and investigate the source of the instrument drift. The analyst should determine if the instrument must be recalibrated before the analysis can continue. All of the samples not bracketed by acceptable calibration verification must be reanalyzed.
Laboratory Blank	Reanalyze the blank to confirm the result. Investigate the source of contamination. If the source of the contamination is isolated to the sample preparation, the entire batch of samples, along with the new laboratory blanks and associated QC samples, should be prepared and/or re-extracted and analyzed. If the source of contamination is isolated to the analysis procedures, reanalyze the entire batch of samples. If reanalysis is not possible, the associated sample results must be flagged to indicate the potential presence of the contamination.
Reference Material	Reanalyze the reference material to confirm the result. Compare this to the matrix spike/matrix spike duplicate recovery data. If adverse trends are noted, reprocess all of the samples associated with the batch.
Matrix Spike	The spiking level should be near the midrange of the calibration curve or at a level that does not require sample dilution. Reanalyze the matrix spike to confirm the result. Review the recovery obtained for the matrix spike duplicate. Review the results of the other QC samples (such as reference materials) to determine if other analytical problems are a potential source of the poor spike recovery.
Matrix Spike Duplicate	The spiking level should be near the midrange of the calibration curve or at a level that does not require sample dilution. Reanalyze the matrix spike duplicate to confirm the result. Review the recovery obtained for the matrix spike. Review the results of the other QC samples (such as reference materials) to determine if other analytical problems are a potential source of the poor spike recovery.
Internal Standard	Check the response of the internal standards. If the instrument continues to generate poor results, terminate the analytical run and investigate the cause of the instrument drift.
Surrogate	Analyze as appropriate for the utilized method. Troubleshoot as needed. If no instrument problem is found, samples should be re-extracted and reanalyzed if possible.
Field Quality Control	Recommended Corrective Action
Field Duplicate	Visually inspect the samples to determine if a high RPD between results could be attributed to sample heterogeneity. For duplicate results due to matrix heterogeneity, or where ambient concentrations are below the reporting limit, qualify the results and document the heterogeneity. All failures should be communicated to the project coordinator, who in turn will follow the process detailed in the method.
Field Blank	Investigate the source of contamination. Potential sources of contamination include sampling equipment, protocols, and handling. The laboratory should report evidence of field contamination as soon as possible so corrective actions can be implemented. Samples collected in the presence of field contamination should be flagged.

14. Inspection/Acceptance for Supplies and Consumables

Each sampling event conducted for the Monitoring Program will require use of appropriate consumables to reduce likelihood of sample contamination. The Field-PM will be responsible for ensuring that all supplies are appropriate prior to their use. Inspection requirements for sampling consumables and supplies are summarized in Table 14-1.

Table 14-1. Inspection / Acceptance Testing Requirements for Consumables and Supplies

Project-related Supplies	Inspection / Testing Specifications	Acceptance Criteria	Frequency	Responsible Person Sampling Containers
Sampling supplies	Visual	Appropriateness; no evident contamination or damage; within expiration date	Each purchase	Field Crew Leader

15. Non Direct Measurements, Existing Data

No data from external sources are planned to be used with this project.

16. Data Management

As previously discussed, the Monitoring Program data management will conform to protocols dictated by the study designs (BASMAA 2017a, b). A summary of specific data management aspects is provided below.

16.1. Field Data Management

All field data will be reviewed for legibility and errors as soon as possible after the conclusion of sampling. All field data that is entered electronically will be hand-checked at a rate of 10% of entries as a check on data entry. Any corrective actions required will be documented in correspondence to the QA Officer.

16.2. Laboratory Data Management

Record keeping of laboratory analytical data for the proposed project will employ standard record-keeping and tracking practices. All laboratory analytical data will be entered into electronic files by the instrumentation being used or, if data is manually recorded, then it will be entered by the analyst in charge of the analyses, per laboratory standard procedures.

Following the completion of internal laboratory quality control checks, analytical results will be forwarded electronically to the Field-PM. The analytical laboratories will provide data in electronic format, encompassing both a narrative and electronic data deliverable (EDD).

17. Assessments and Response Actions

17.1. Readiness Reviews

The Field-PM will review all field equipment, instruments, containers, and paperwork to ensure that everything is ready prior to each sampling event. All sampling personnel will be given a brief review of the goals and objectives of the sampling event and the sampling procedures and equipment that will be used to achieve them. It is important that all field equipment be clean and ready to use when it is needed. Therefore, prior to using all sampling and/or field measurement equipment, each piece of equipment will be checked to make sure that it is in proper working order. Equipment maintenance records will be checked to ensure that all field instruments have been properly maintained and that they are ready for use. Adequate supplies of all preservatives, bottles, labels, waterproof pens, etc. will be checked before each field event to make sure that there are sufficient supplies to successfully support each sampling event, and, as applicable, are within their expiration dates. It is important to make sure that all field activities and measurements are properly recorded in the field. Therefore, prior to starting each field event, necessary paperwork such as logbooks, chain of custody record forms, etc. will be checked to ensure that sufficient amounts are available during the field event. In the event that a problem is discovered during a readiness review it will be noted in the field log book and corrected before the field crew is deployed. The actions taken to correct the problem will also be documented with the problem in the field log book. This information will be communicated by the Field-PM prior to conducting relevant sampling. The Field-PM will track corrective actions taken.

17.2. Post Sampling Event Reviews

The Field-PM will be responsible for post sampling event reviews. Any problems that are noted will be documented along with recommendations for correcting the problem. Post sampling event reviews will be conducted following each sampling event in order to ensure that all information is complete and any deviations from planned methodologies are documented. Post sampling event reviews will include field sampling activities and field measurement documentation in order to help ensure that all information is complete. The reports for each post sampling event will be used to identify areas that may be improved prior to the next sampling event.

17.3. Laboratory Data Reviews

The Field-PM will be responsible for reviewing the laboratory's data for completeness and accuracy. The data will also be checked to make sure that the appropriate methods were used and that all required QC data was provided with the sample analytical results. Any laboratory data that is discovered to be incorrect or missing will immediately be reported to the both the laboratory and Consultant-PM. The laboratory's QA manual details the procedures that will be followed by laboratory personnel to correct any invalid or missing data. The Consultant-PM has the authority to request re-testing if a review of any of the laboratory data is found to be invalid or if it would compromise the quality of the data and resulting conclusions from the proposed project.

18. Instrument/Equipment Testing, Inspection and Maintenance

18.1. Field Equipment

Field measurement equipment will be checked for operation in accordance with manufacturer's specifications. All equipment will be inspected for damage when first employed and again when returned from use. Maintenance logs will be kept and each applicable piece of equipment will have its own log that documents the dates and description of any problems, the action(s) taken to correct problem(s), maintenance procedures, system checks, follow-up maintenance dates, and the person responsible for maintaining the equipment.

18.2. Laboratory Equipment

All laboratories providing analytical support for chemical or biological analyses will have the appropriate facilities to store, prepare, and process samples. Moreover, appropriate instrumentation and staff to provide data of the required quality within the schedule required by the program are also required. Laboratory operations must include the following procedures:

- A program of scheduled maintenance of analytical balances, microscopes, laboratory equipment, and instrumentation.
- Routine checking of analytical balances using a set of standard reference weights (American Society of Testing and Materials (ASTM) Class 3, NIST Class S-1, or equivalents).
- Checking and recording the composition of fresh calibration standards against the previous lot, wherever possible. Acceptable comparisons are < 2% of the previous value.
- Recording all analytical data in bound (where possible) logbooks, with all entries in ink, or electronic format.
- Monitoring and documenting the temperatures of cold storage areas and freezer units once per week.
- Verifying the efficiency of fume hoods.
- Having a source of reagent water meeting ASTM Type I specifications (ASTM, 1984) available in sufficient quantity to support analytical operations. The conductivity of the reagent water will not exceed 18 megaohms at 25°C. Alternately, the resistivity of the reagent water will exceed 10 mmhos/cm.
- Labeling all containers used in the laboratory with date prepared, contents, initials of the individual who prepared the contents, and other information, as appropriate.
- Dating and safely storing all chemicals upon receipt. Proper disposal of chemicals when the expiration date has passed.
- Having QAPP, SOPs, analytical methods manuals, and safety plans readily available to staff.
- Having raw analytical data, such as chromatograms, accessible so that they are available upon request.

Laboratories will maintain appropriate equipment per the requirements of individual laboratory SOPs and will be able to provide information documenting their ability to conduct the analyses with the required level of data quality. Such information might include results from interlaboratory comparison studies, control charts and summary data of internal QA/QC checks, and results from certified reference material analyses.

19. Instrument/Equipment Calibration and Frequency

19.1. Field Measurements

Any equipment used should be visually inspected during mobilization to identify problems that would result in loss of data. As appropriate, equipment-specific SOPs should be consulted for equipment calibration.

19.2. Laboratory Analyses

19.2.1. In-house Analysis – XRF Screening

A portable XRF analyzer will be used as a screening tool to estimate the chlorine concentration in each caulk sample. Since caulk often contains in excess of 1% PCBs and detection limits of portable XRF may be in the ppm range, the portable XRF may be able to detect chlorine within caulk containing PCBs down to about 0.1%. The analysis will be performed on the field samples using a test stand. The analyzer will be calibrated for chlorine using plastic pellet European reference materials (EC680 and EC681) upon first use, and standardized each time the instrument is turned on and prior to any caulk Cl analysis. The standardization procedure will entail a calibration analysis of the materials provided/recommended with the XRF analyzer. Analyses will be conducted in duplicate on each sample and notes kept. The mean will be used for comparison to GC–MS results.

19.2.2. Contract Laboratory Analyses

The procedures for and frequency of calibration will vary depending on the chemical parameters being determined. Equipment is maintained and checked according to the standard procedures specified in each laboratory's instrument operation instruction manual.

Upon initiation of an analytical run, after each major equipment disruption, and whenever on-going calibration checks do not meet recommended DQOs (see Section 13), analytical systems will be calibrated with a full range of analytical standards. Immediately after this procedure, the initial calibration must be verified through the analysis of a standard obtained from a different source than the standards used to calibrate the instrumentation and prepared in an independent manner and ideally having certified concentrations of target analytes of a CRM or certified solution. Frequently, calibration standards are included as part of an analytical run, interspersed with actual samples.

Calibration curves will be established for each analyte and batch analysis from a calibration blank and a minimum of three analytical standards of increasing concentration, covering the range of expected sample concentrations. Only those data resulting from quantification within the demonstrated working calibration range may be reported by the laboratory.

The calibration standards will be prepared from reference materials available from the EPA repository, or from available commercial sources. The source, lot number, identification, and purity of each reference material will be recorded. Neat compounds will be prepared weight/volume using a calibrated analytical balance and Class A volumetric flasks. Reference solutions will be diluted using Class A volumetric glassware. Individual stock standards for each analyte will be prepared. Combination working standards will be prepared by volumetric dilution of the stock standards. The calibration standards will be stored at -20° C. Newly prepared standards will be compared with existing standards prior to their use. All solvents

used will be commercially available, distilled in glass, and judged suitable for analysis of selected chemicals. Stock standards and intermediate standards are prepared on an annual basis and working standards are prepared every three months.

Sampling and analytical logbooks will be kept to record inspections, calibrations, standard identification numbers, the results of calibrations, and corrective action taken. Equipment logs will document instrument usage, maintenance, repair and performance checks. Daily calibration data will be stored with the raw sample data

20. Data Review, Verification, and Validation

Defining data review, verification, and validation procedures helps to ensure that Monitoring Plan data will be reviewed in an objective and consistent manner. Data review is the in-house examination to ensure that the data have been recorded, transmitted, and processed correctly. The Field-PM will be responsible for initial data review for field forms and field measurements; QA Officer will be responsible for doing so for data reported by analytical laboratories. This includes checking that all technical criteria have been met, documenting any problems that are observed and, if possible, ensuring that deficiencies noted in the data are corrected.

In-house examination of the data produced from the proposed Monitoring Program will be conducted to check for typical types of errors. This includes checking to make sure that the data have been recorded, transmitted, and processed correctly. The kinds of checks that will be made will include checking for data entry errors, transcription errors, transformation errors, calculation errors, and errors of data omission.

Data generated by Program activities will be reviewed against MQOs that were developed and documented in Section 13. This will ensure that the data will be of acceptable quality and that it will be SWAMP-comparable with respect to minimum expected MQOs.

QA/QC requirements were developed and documented in Sections 13.1 and 13.2, and the data will be checked against this information. Checks will include evaluation of field and laboratory duplicate results, field and laboratory blank data, matrix spike recovery data, and laboratory control sample data pertinent to each method and analytical data set. This will ensure that the data will be SWAMP-comparable with respect to quality assurance and quality control procedures.

Field data consists of all information obtained during sample collection and field measurements, including that documented in field log books and/or recording equipment, photographs, and chain of custody forms. Checks of field data will be made to ensure that it is complete, consistent, and meets the data management requirements that were developed and documented in Section 13.1.

Lab data consists of all information obtained during sample analysis. Initial review of laboratory data will be performed by the laboratory QA/QC Officer in accordance with the lab's internal data review procedures. However, upon receipt of laboratory data, the Lab-PM will perform independent checks to ensure that it is complete, consistent, and meets the data management requirements that were developed and documented in Section 13.2. This review will include evaluation of field and laboratory QC data and also making sure that the data are reported in compliance with procedures developed and documented in Section 7.

Data verification is the process of evaluating the completeness, correctness, and conformance / compliance of a specific data set against the method, procedural, or contractual specifications. The Lab-PM and Data Manager will conduct data verification, as described in Section 13 on Quality Control, in order to ensure that it is SWAMP-comparable with respect to completeness, correctness, and conformance with minimum requirements.

Data will be separated into three categories for use with making decisions based upon it. These categories are: (1) data that meets all acceptance requirements, (2) data that has been determined to be unacceptable for use, and (3) data that may be conditionally used and that is flagged as per US EPA specifications.

21. Verification and Validation Methods

Defining the methods for data verification and validation helps to ensure that Program data are evaluated objectively and consistently. For the proposed Program many of these methods have been described in Section 20. Additional information is provided below.

All data records for the Monitoring Program will be checked visually and will be recorded as checked by the checker's initials as well as with the dates on which the records were checked. Consultant Team staff will perform an independent re-check of at least 10% of these records as the validation methodology.

All of the laboratory's data will be checked as part of the verification methodology process. Each contract laboratory's Project Analyst will conduct reviews of all laboratory data for verification of their accuracy.

Any data that is discovered to be incorrect or missing during the verification or validation process will immediately be reported to the Consultant-PM. If errors involve laboratory data then this information will also be reported to the laboratory's QA Officer. Each laboratory's QA manual details the procedures that will be followed by laboratory personnel to correct any invalid or missing data. The laboratory's QA Officer will be responsible for reporting and correcting any errors that are found in the data during the verification and validation process.

If there are any data quality problems identified, the QA Officer will try to identify whether the problem is a result of project design issues, sampling issues, analytical methodology issues, or QA/QC issues (from laboratory or non-laboratory sources). If the source of the problems can be traced to one or more of these basic activities then the person or people in charge of the areas where the issues lie will be contacted and efforts will be made to immediately resolve the problem. If the issues are too broad or severe to be easily corrected then the appropriate people involved will be assembled to discuss and try to resolve the issue(s) as a group. The QA Officer has the final authority to resolve any issues that may be identified during the verification and validation process.

22. Reconciliation with User Requirements

The purpose of the Monitoring Program is to comply with Provisions of the MRP and provide data that can be used to identify sources of PCBs to urban runoff, and to evaluate management action effectiveness in removing POCs from urban runoff in the Bay Area. The objectives of the Monitoring Program are to provide the following outcomes:

1. Satisfy MRP Provision C.8.f. requirements for POC monitoring for source identification;

2. Satisfy MRP Provision C.12.e.ii requirements to evaluate PCBs presence in caulks/sealants used in storm drain or roadway infrastructure in public ROWs;
3. Report the range of PCB concentrations observed in 20 composite samples of caulk/sealant collected from structures installed or rehabilitated during the 1970's;
4. Satisfy MRP Provision C.8.f. requirements for POC monitoring for management action effectiveness;
5. Quantify the annual mass of mercury and PCBs captured in HDS Unit sumps during maintenance; and
6. Identify BSM mixtures for future field testing that provide the most effective mercury and PCBs treatment in laboratory column tests.

Information from field data reports (including field activities, post sampling events, and corrective actions), laboratory data reviews (including errors involving data entry, transcriptions, omissions, and calculations and laboratory audit reports), reviews of data versus MQOs, reviews against QA/QC requirements, data verification reports, data validation reports, independent data checking reports, and error handling reports will be used to determine whether or not the Monitoring Program's objectives have been met. Descriptions of the data will be made with no extrapolation to more general cases.

Data from all monitoring measurements will be summarized in tables. Additional data may also be represented graphically when it is deemed helpful for interpretation purposes.

The above evaluations will provide a comprehensive assessment of how well the Program meets its objectives. The final project reports will reconcile results with project MQOs.

23. References

California Regional Water Quality Control Board, San Francisco Bay Region. *Municipal Regional Stormwater NPDES Permit Order R2-2015-0049 NPDES Permit No. CAS612008*. November 19, 2015.

BASMAA. 2016. *BASMAA Regional Monitoring Coalition Creek Status and Toxicity and Pesticide Monitoring Standard Operating Procedures*. Prepared for Bay Area Stormwater Management Agencies Association. Version 3, March 2016.

BASMAA 2017a. *The Evaluation of PCBs Presence in Public Roadway and Storm Drain Infrastructure Caulk and Sealants Study Design*. Prepared by EOA Inc. and the San Francisco Estuary Institute (SFEI). June 2017.

BASMAA 2017b. *POC Monitoring for Management Action Effectiveness Study Design*. Prepared by the Office of Water Programs, Sacramento State, CA, EOA Inc., and the San Francisco Estuary Institute (SFEI). July 2017.

BASMAA, 2017c. *Clean Watershed for a Clean Bay (CW4CB) Final Report*. Prepared for Bay Area Stormwater Management Agencies Association. Prepared by Geosyntec and EOA, Inc., May 2017.

Klosterhaus, S. McKee, L.J. Yee, D., Kass, J.M., and Wong, A. 2014. Polychlorinated Biphenyls in the Exterior Caulk of San Francisco Bay Area Buildings, California, USA. *Environment International* 66, 38-43.

Surface Water Ambient Monitoring Program Quality Assurance Team, 2013. *SWAMP Quality Assurance Project Plan*. Prepared for the California State Water Quality Control Board. 2013.

24. Appendix A: Field Documentation

Caulk/Sealant Sampling Field Data Sheet			Composite ID:			Contractor:			Pg of Pgs				
Sample ID:			Date (mm/dd/yyyy):				Personnel:			Failure Reason			
Photos (Y / N)			ArrivalTime:		DepartureTime:								
Photo Log Identifier			Land-Use at the Sample Location:			Commercial (pre-1980; post 1980)			Open Space				
			Industrial (pre-1980; post-1980)			Residential (pre 1980; post 1980)			Other:				
Description of Structure: (Do not include any information on the location of the structure)						Diagram of Structure (if needed) to identify where caulk/sealants were located in/on structure							
Structure Type:		Storm Drain Catch Basin	Roadway Surface		Sidewalk	Curb/Gutter		Bridge					
		Other:											
Structure Material:		Concrete	Asphalt		Other:								
Condition of Structure:		Good	Fair		Poor	Other:							
Year of Strucutre Construction													
Year of Repair													
Description of Caulk or Sealant Sample Collected:													
Application or Usage		Caulk	caulk between adjoining surfaces of same material (e.g., concrete-concrete); Describe:										
			caulk between adjoining surfaces of different types of material (e.g., concrete-asphalt); Describe:										
			Other:										
		Sealant	Crack Repair (describe):										
Other:													
Color													
Texture		Hard/brittle	Soft/pliable		Other:								
Condition		Good (intact/whole)		Poor (crumbling/disintegrating)			Other:						
Location		Surface	Between Joints		Submerged	Exposed	At street level	Below street level		Other:			
Amount of Caulk/Sealant observed on structure		Crack dimensions:					Spacing of expansion joints						
		Length&width of caulk bead sampled:					Other:						
Samples Taken													
COLLECTION DEVICE:						Equipment type used:							
SITE/SAMPLING DESCRIPTION AND COMMENTS:													

HDS Unit Sampling Field Data Sheet (Sediment Chemistry)				Contractor:		Pg		of		Pgs	
City:		Date (mm/dd/yyyy):		/ /		*Contractor:					
HDS Catchment ID:		ArrivalTime:		DepartureTime:		*SampleTime (1st sample):			Failure Reason		
		Personnel:									
Photos (Y / N)		*GPS/DGPS	Lat (dd.ddddd)	Long (ddd.ddddd)	Address, Location, and Sketches (if needed)						
Photo Log Identifier		Target (if known):									
		*Actual:									
		GPS Device:									
		Estimate of Volume of Sediment in the HDS unit sump prior to cleanout:									
Estimate of Volume of Sediment REMOVED from the HDS unit sump during the cleanout:											
Env. Conditions		WIND DIRECTION (from):									
SITE ODOR:	None, Sulfides, Sew age, Petroleum, Smoke, Other _____										
SKY CODE:	Clear, Partly Cloudy, Overcast, Fog, Smoky, Hazy										
PRECIP:	None, Fog, Drizzle, Rain										
PRECIP (last 24 hrs):	Unknow n, <1", >1", None										
SOILODOR:	None, Sulfides, Sew age, Petroleum, Mixed, Other _____										
SOILCOLOR:	Colorless, Green, Yellow, Brown										
SOILCOMPOSITION:	Silt/Clay, Sand, Gravel, Cobble, Mixed, Debris										
SOILPOSITION	Submerged, Exposed										
Samples Taken (3 digit ID nos. of containers filled)				Field Dup at Site? YES / NO: (create separate datasheet for FDs, with unique IDs (i.e., blind samples))							
COLLECTION DEVICE:		Equipment type used: Scoop (SS / PC / PE), Core (SS / PC / PE), Grab (Van Veen / Eckman / Petite Ponar), Broom (nylon, natural fiber)									
Sample ID (City-Catchment ID-Sample)	Depth Collec (cm)	Composite / Grab (C / G)	Grain Size	PCBs	Hg	Bulk Density	TOC	OTHER			
SITE/SAMPLING DESCRIPTION AND COMMENTS:											

Stormwater Influent Samples – Office of Water Programs

Sample Receiving					
Date (mm/dd/yy):			Time (24 hr):	Team Member's Initial:	
Carboy	Temperature	pH	Observations		
1					
2					
3					
4					
5					
6					
7					

Stormwater Column Tests – Office of Water Programs

Sampling Run			
Date (mm/dd/yy):	Time (24 hr) :	Team Member's Initials:	Column ID:

During Test - Timed Measurements

Time	Water Depth	Media Condition	Other Observations

Grab Sample - Beginning of Run

Time	Water Depth	Turbidity (NTU)	Temp	pH	Other Observations

Grab Sample - Middle of Run

Time	Water Depth	Turbidity (NTU)	Temp	pH	Other Observations

Grab Sample - End of Run

Time	Water Depth	Turbidity (NTU)	Temp	pH	Other Observations

Grab Sample - Mercury

Time	Water Depth	Turbidity (NTU)	Temp	pH	Other Observations

25. Appendix B: Laboratory Standard Operating Procedures (SOPs)

APPENDIX C: PROPOSED BIOCHAR SELECTION FACTORS

The primary goal of this study is to select a biochar and bioretention soil mix (BSM) for field testing which will be conducted to assess improved removal of PCBs and mercury. The selection for field tests will be informed by column tests performed by this study. This memorandum contains a review of known biochar available in the Western United States. Five biochars are needed for column tests; nine biochars will be obtained and mixed with BSM at a ratio of 75 percent BSM and 25 percent biochar. These mixes will be tested hydraulically according to the alternative BSM specification to see which mixes pass the hydraulic requirement of an infiltration rate of 5-12 inches per hour. If more than five biochar mixes pass the hydraulic test then five will be chosen based on probable treatment efficiency and cost. Factors that will be used to determine probable treatment efficiency are pH, surface area, source material, pyrolysis method, and hydrophobicity.

Feasibility Criteria

Three criteria were chosen to screen potential biochars for sample gathering. All nine of the biochars selected for initial hydraulic testing have met reasonable expectations of cost, availability, and consistency.

Cost

Generally, biochar is a byproduct of the lumber industry or more recently household yard waste and tree trimmings. This byproduct is cheap and plentiful in certain regions especially when compared to more costly adsorbents commonly used to treat stormwater such as zeolite, activated alumina, activated carbon, or proprietary engineered media. Because even a relatively expensive biochar can be considered inexpensive when compared to other soil additives, biochars will not be excluded based solely on cost.

Availability

The selection process for the different biochars ensures that local soil suppliers have consistent access to the tested biochar in commercial quantities. To ensure availability, producers that are well established and offer biochar in commercial quantities in stock year round were prioritized.

Consistency

Biochar can be made from a variety of feedstocks and processed at various temperatures, which will produce biochars with varying properties and treatment capacities. To ensure that the biochars tested in this study will be available with the same properties, only suppliers who use a consistent feedstock and process will be considered.

Performance Criteria

Hydraulic Conductivity

A current requirement of alternative BSM is to have an infiltration rate between 5 and 12 inches per hour with a long-term infiltration rate of at least 5 inches per hour. In a previous study, the hydraulic conductivity of a biochar was studied before and after having the fines removed by sieving. The sample with fines removed had a hydraulic conductivity nearly four times higher than the one with fines (Yargicoglu et al., 2015). Any biochar amended BSM that does not achieve 5 to 12 inches per hour infiltration rate will be removed from the study.

Soil pH

There is a correlation between increased pyrolysis temperatures and increased pH, though there is a large variation between feedstocks (Cantrell et al., 2012). If the pH is raised enough it could affect plant health as several key nutrients required by plants can be immobilized in high pH soils. Ideally the biochars chosen should have a pH as close to seven as possible.

Surface Area

Surface area is arguably the most important characteristic for treatment performance. Adsorption capacity is directly related to available surface area of the adsorbent. Some biochars have been lab tested to measure surface area via N₂ adsorption but not many. From literature, a correlation between pyrolysis temperature and surface area is established, pyrolysis temperatures of 600-700 C show much higher surface areas than those produced at 500 C or less (Ahmad et al., 2014).

Hydrophobicity

Hydrophobicity is important to our study because hydrophobic substances, like PCBs, in a water solution are attracted to hydrophobic surfaces like biochar where they are adsorbed and removed from the water. Hydrophobicity is a difficult characteristic to measure, requiring either specialized equipment or lengthy experimentation. However, it has been well documented that hydrophobicity in biochar decreases as pyrolysis temperature increases (Zimmerman, 2010). The hydrophobicity in biochar is likely due to hydrophobic substances that are not completely volatilized at lower temperatures (Gray et al., 2014). Hydrophobicity in biochar will decline over time as these hydrophobic substances are consumed by microbes or oxidized, eventually making the biochar hydrophilic (Zimmerman, 2010). This is a concern for long-term treatment effectiveness if treatment depends on hydrophobicity.

Source Material and Pyrolysis Method

Many studies have compared the physical and chemical properties of biochar produced using different feedstocks and different methods of pyrolysis. However, because we have chosen to only study biochars that meet our availability requirements we do not have the option to make source material a primary selection criteria. Most of the biochars that meet our selection requirements are produced from woodchips and other industrial forestry residues. Consequently, biochars will be ordered by pyrolysis temperature. A range of pyrolysis temperatures are recommended since low temperatures tend to produce more hydrophobic biochars and higher temperatures produce biochars with more surface area (Zimmerman, 2010).

Probable Treatment Efficiency

From literature there are many factors that will affect overall treatment efficiency in a biochar. To simplify the selection process, pyrolysis temperature was chosen as the factor to represent treatment efficiency. Because pyrolysis temperature affects both surface area and hydrophobicity directly, biochars will be chosen that are produced at a wide range of temperatures. This will ensure biochars with the greatest surface area, the greatest hydrophobicity, and combinations of the two will be tested.

Table 1. Biochar Selection Table

Biochar Name	Cost (\$/yd ³)	Pyrolysis Temp (Degrees C)
1. Pacific	\$ 90.00	700
2. Sonoma Biochar	\$ 240.00	1315
3. Rogue Biochar	\$ 249.50	700
4. BioChar Now - Medium	\$ 350.00	600
5. Sunriver High Porosity Biochar	\$ 500.00	500
6. Biochar Solutions (CW4CB)	\$ 225.00	700
7. Agrosorb	\$ 250.00	900
8. BlackSorb	\$ 250.00	900
9. Cool Terra CF-11	\$ 700.00	600
10. Phoenix	\$ 254.00	700

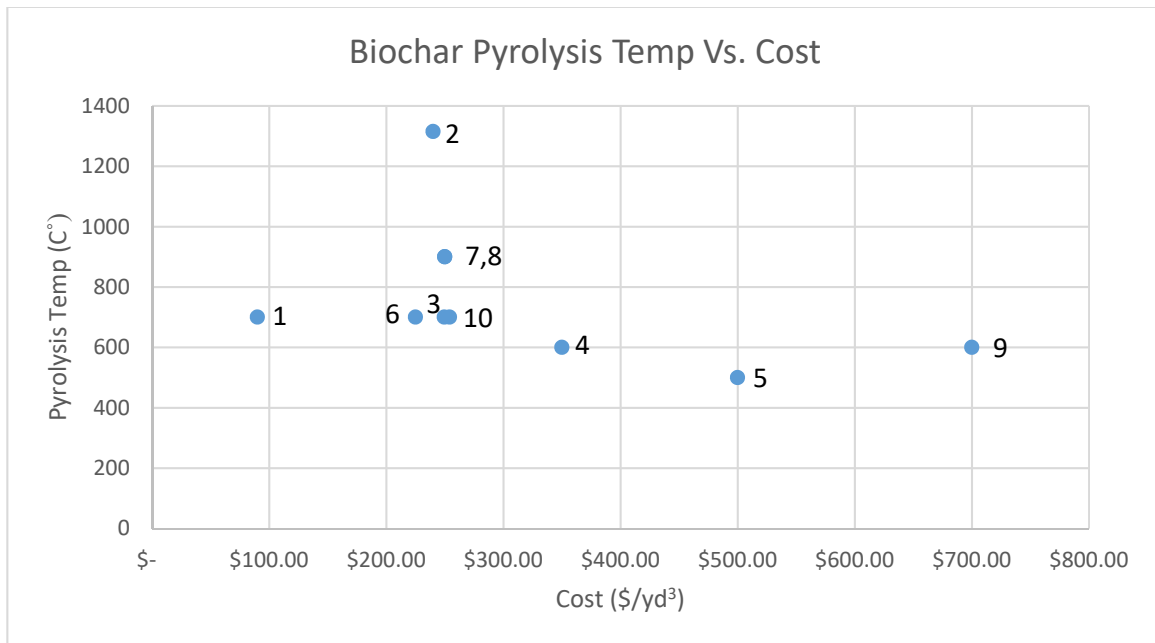

Figure 1. Biochar Pyrolysis Temperature Vs. Cost

References

- Yargicoglu, E.N., Sadasivam, B.Y., Reddy, K.R., Spokas, K., Physical and Chemical Characterization of Waste Wood Derived Biochars, *Waste Management*, Volume 36, February 2015, Pages 256-268, ISSN 0956-053X, <https://doi.org/10.1016/j.wasman.2014.10.029>.
- Ahmad, M., Rajapaksha, A.U., Lim, J.E., Zhang M., Bolan N., Mohan D., Vithanage M., Lee S.S., Ok Y.S., Biochar as a Sorbent for Contaminant Management in Soil and Water: a Review, in *Chemosphere*, Volume 99, 2014, Pages 19-33, ISSN 0045-6535, <https://doi.org/10.1016/j.chemosphere.2013.10.071>.
- Cantrell, K.B., Hunt, P.G., Uchimiya, M., Novak, J.M., Ro, K.S., Impact of Pyrolysis Temperature and Manure Source on Physicochemical Characteristics of Biochar, in *Bioresource Technology*, Volume 107, 2012, Pages 419-428, ISSN 0960-8524, <https://doi.org/10.1016/j.biortech.2011.11.084>.
- Zimmerman, A.R, Abiotic and Microbial Oxidation of Laboratory-Produced Black Carbon (Biochar), *Environmental Science & Technology*, Volume 44, January 2010, Pages 1295-1301, <http://pubs.acs.org/doi/abs/10.1021/es903140c>.
- Gray, M., Johnson, M.G., Dragila, M.I., Kleber, M., Water Uptake in Biochars: The Roles of Porosity and Hydrophobicity, In *Biomass and Bioenergy*, Volume 61, 2014, Pages 196-205, ISSN 0961-9534, <https://doi.org/10.1016/j.biombioe.2013.12.010>.

APPENDIX D: HYDRAULIC TEST RESULTS

Appendix D: Hydraulic Test Results

Blacksorb biochar-amended BSM Compacted to 85% MDD of Standard Proctor

Length	15.2	cm
Area	182.3222	cm ²

Manometers										
H1	H2	head	Q	t	Q/At	h/L	Temp	k cm/s	k corrected	k in/hr
43.7	35.1	8.6	46	240	0.001051	0.565789	19.9	0.001858	0.00186303	2.640514
42.75	27.6	15.15	49.5	150	0.00181	0.996711	19.9	0.001816	0.00182084	2.580724
42.3	24.7	17.6	49.5	135	0.002011	1.157895	19.9	0.001737	0.00174153	2.468306
									Average K	2.563181

Appendix D: Hydraulic Test Results

Sonoma biochar-amended BSM Compacted to 85% MDD of Standard Proctor

Length	15.2	cm
Area	182.3222	cm ²

Manometers										
H1	H2	head	Q	t	Q/At	h/L	Temp	k cm/s	k corrected	k in/hr
43.98	37.1	6.88	48.8	165	0.001622	0.452632	20	0.003584	0.00358473	5.080723
43.25	32.3	10.95	48	100	0.002633	0.720395	20	0.003655	0.00365541	5.1809
42.65	28.05	14.6	47	75	0.003437	0.960526	20	0.003578	0.00357926	5.072965
									Average K	5.111529

Appendix D: Hydraulic Test Results

Pacific biochar-amended BSM Compacted to 85% MDD of Standard Proctor

Length	15.2	cm
Area	182.3222	cm ²

Manometers										
H1	H2	head	Q	t	Q/At	h/L	Temp	k cm/s	k corrected	k in/hr
42.2	38.1	4.1	43.5	225	0.00106	0.269737	20.5	0.003931	0.0038846	5.505762
42.1	38	4.1	43	225	0.001048	0.269737	20.5	0.003886	0.00384	5.442478
40.4	34.2	6.2	43	150	0.001572	0.407895	20.5	0.003855	0.003809	5.398587
35.2	24.15	11.05	45	90	0.002742	0.726974	20.5	0.003772	0.0037276	5.283264
									Average K	5.407523

Appendix D: Hydraulic Test Results

Sunriver biochar-amended BSM Compacted to 85% MDD of Standard Proctor

Length	15.2	cm
Area	182.3222	cm ²

Manometers										
H1	H2	head	Q	t	Q/At	h/L	Temp	k cm/s	k corrected	k in/hr
43.2	40.7	2.5	47	280	0.000921	0.164474	21.5	0.005598	0.005399934	7.65345
42.8	39.6	3.2	47.5	210	0.001241	0.210526	21.5	0.005893	0.005684771	8.057156
41.7	36.6	5.1	46	128	0.001971	0.335526	21.5	0.005875	0.005667171	8.032211
39.85	32.2	7.65	48	90	0.002925	0.503289	21.5	0.005812	0.00560694	7.946844
39.4	31.8	7.6	46.5	90	0.002834	0.5	21.5	0.005668	0.005467458	7.749154
34.5	22.5	12	200	255	0.004302	0.789474	21.5	0.005449	0.005256507	7.450167
33.4	22.3	11.1	200	255	0.004302	0.730263	21.5	0.005891	0.00568271	8.054234
33.1	22.2	10.9	200	305	0.003597	0.717105	21.5	0.005015	0.004838294	6.857425
32.5	22.15	10.35	200	305	0.003597	0.680921	21.5	0.005282	0.005095402	7.221829
									Average K	7.669163

Appendix D: Hydraulic Test Results

Rogue biochar-amended BSM Compacted to 85% MDD of Standard Proctor

Length	15.2	cm		viscosity at 20	1.0034
Area	182.3222	cm ²		viscosity at 22	0.955
				Ratio	0.951764

Manometers										
H1	H2	head	Q	t	Q/At	h/L	Temp	k cm/s	k corrected	k in/hr
44.65	42.5	2.15	40	270	0.000813	0.141447	22	0.005745	0.005476319	7.761713
43.5	35.75	7.75	48.5	90	0.002956	0.509868	22	0.005797	0.005526225	7.832444
43.3	34.75	8.55	45	75	0.003291	0.5625	22	0.00585	0.005577199	7.904691
42.6	31.5	11.1	46.5	60	0.004251	0.730263	22	0.005821	0.005548936	7.864634
42	28.75	13.25	41.7	45	0.005083	0.871711	22	0.005831	0.005558258	7.877845
43	34.95	8.05	50.5	90	0.003078	0.529605	22	0.005811	0.005539671	7.851503
									Average K	7.848805

Appendix D: Hydraulic Test Results

Phoenix biochar-amended BSM Compacted to 85% MDD of Standard Proctor

Length	15.2	cm
Area	182.3222	cm ²

Manometers										
H1	H2	head	Q	t	Q/At	h/L	Temp	k cm/s	k corrected	k in/hr
42.58	39.9	2.68	49	210	0.00128	0.176316	19.5	0.007258	0.007349893	10.41717
40.3	34.9	5.4	47.5	100	0.002605	0.355263	19.5	0.007333	0.007425726	10.52465
38.9	31.65	7.25	49.2	80	0.003373	0.476974	19.5	0.007072	0.007161041	10.14951
									Average K	10.36378

Appendix D: Hydraulic Test Results

Voss Compacted to 85% MDD of Standard Proctor

Length	15.2	cm		viscosity at 20	1.0034
Area	182.3222	cm ²		viscosity at 21	0.979
				Ratio	0.975683

Manometers										
H1	H2	head	Q	t	Q/At	h/L	Temp	k cm/s	k corrected	k in/hr
40.2	37.35	2.85	44.5	165	0.001479	0.1875	21	0.007889	0.007702247	10.91657
39.81	33.45	6.36	43	75	0.003145	0.418421	21	0.007515	0.007337301	10.39932
39.55	30.8	8.75	46	58	0.00435	0.575658	21	0.007557	0.00737748	10.45627
39	27.5	11.5	203	176	0.006326	0.756579	21	0.008362	0.008163413	11.57019
									Average K	10.83559

Appendix D: Hydraulic Test Results

BioChar Solutions biochar-amended BSM Compacted to 85% MDD of Standard Proctor

Length	15.2	cm
Area	182.3222	cm ²

Manometers										
H1	H2	head	Q	t	Q/At	h/L	Temp	k cm/s	k corrected	k in/hr
44.2	41.7	2.5	49.5	220	0.001234	0.164474	20	0.007503	0.00750502	10.63704
43.5	39.05	4.45	49.5	120	0.002262	0.292763	20	0.007728	0.00772989	10.95575
42.7	36.48	6.22	49.5	85	0.003194	0.409211	20	0.007805	0.00780738	11.06558
42.3	35.4	6.9	46.5	70	0.003643	0.453947	20	0.008026	0.00802814	11.37847
41.45	32.7	8.75	47.8	58	0.00452	0.575658	20	0.007852	0.00785419	11.13192
									Average K	11.03375

Appendix D: Hydraulic Test Results

Agrosorb biochar-amended BSM Compacted to 85% MDD of Standard Proctor

Length	15.2	cm		viscosity at 20	1.0034
Area	182.3222	cm ²		viscosity at 22	0.955
				Ratio	0.951764

Manometers										
H1	H2	head	Q	t	Q/At	h/L	Temp	k cm/s	k corrected	k in/hr
44.23	40.58	3.65	47	100	0.002578	0.240132	20.4	0.010735	0.0106337	15.07137
43.09	36.4	6.69	45.2	50	0.004958	0.440132	20.4	0.011265	0.0111589	15.81576
43.05	36.3	6.75	45.4	50	0.00498	0.444079	20.4	0.011215	0.0111086	15.74453
41.82	32.2	9.62	51.2	40	0.007021	0.632895	20.4	0.011093	0.0109879	15.57337
41.82	32.09	9.73	38	30	0.006947	0.640132	20.4	0.010853	0.0107505	15.23692
40.85	28.58	12.27	39.1	25	0.008578	0.807237	20.4	0.010627	0.0105262	14.91901
40.85	28.5	12.35	39	25	0.008556	0.8125	20.4	0.010531	0.0104313	14.78446
44	39.9	4.1	41.8	85	0.002697	0.269737	20.4	0.009999	0.009905	14.03852
									Average K	15.14799

Appendix D: Hydraulic Test Results

Biochar Now biochar-amended BSM Compacted to 85% MDD of Standard Proctor

Length	15.2	cm
Area	182.3222	cm ²

Manometers										
H1	H2	head	Q	t	Q/At	h/L	Temp	k cm/s	k corrected	k in/hr
44.3	40.8	3.5	48	90	0.002925	0.230263	21	0.012704	0.01240272	17.57866
44	39.3	4.7	49	70	0.003839	0.309211	21	0.012417	0.01212234	17.18127
43.5	36.85	6.65	49.5	50	0.00543	0.4375	21	0.012411	0.01211713	17.17389
42.85	34.25	8.6	45.1	35	0.007068	0.565789	21	0.012491	0.01219541	17.28483
42.15	31.35	10.8	200	128	0.00857	0.710526	21	0.012061	0.01177559	16.68981
									Average K	17.18169

APPENDIX E: BIOCHAR PARTICLE SIZE DISTRIBUTION

Sieve Analysis Data Sheet

ASTM D422-63(2007)

Project Name: _____ Tested By: RH & JB Date: 7/10/2018
 Location: _____ Checked By: _____ Date: _____
 Boring No: _____ Test Number: _____
 Sample Depth: _____ Gnd Elev.: _____

Biochar Type: BioChar Solutions

Weight of Container (g): 52.4 Weight of Container & Soil (g): 97.0
 Weight of Dry Sample (g): 44.6

Sieve Number	Diameter (mm)	Mass of Container (g)	Mass of Container & Soil (g)	Soil Retained (g)	Soil Retained (%)	Soil Passing (%)
0.5	12.70	13.9837	15.1551	1.2	2.6	97.4
4	4.75	13.9837	35.5409	21.6	47.4	50.0
30	0.60	13.9837	33.8176	19.8	43.6	6.4
50	0.30	13.9837	14.4764	0.5	1.1	5.3
100	0.15	13.9837	14.4401	0.5	1.0	4.3
200	0.075	0.7018	1.2622	0.6	1.2	3.0
Pan		0.7018	2.0797	1.4	3.0	0.0
TOTAL:				45.4	100.0	

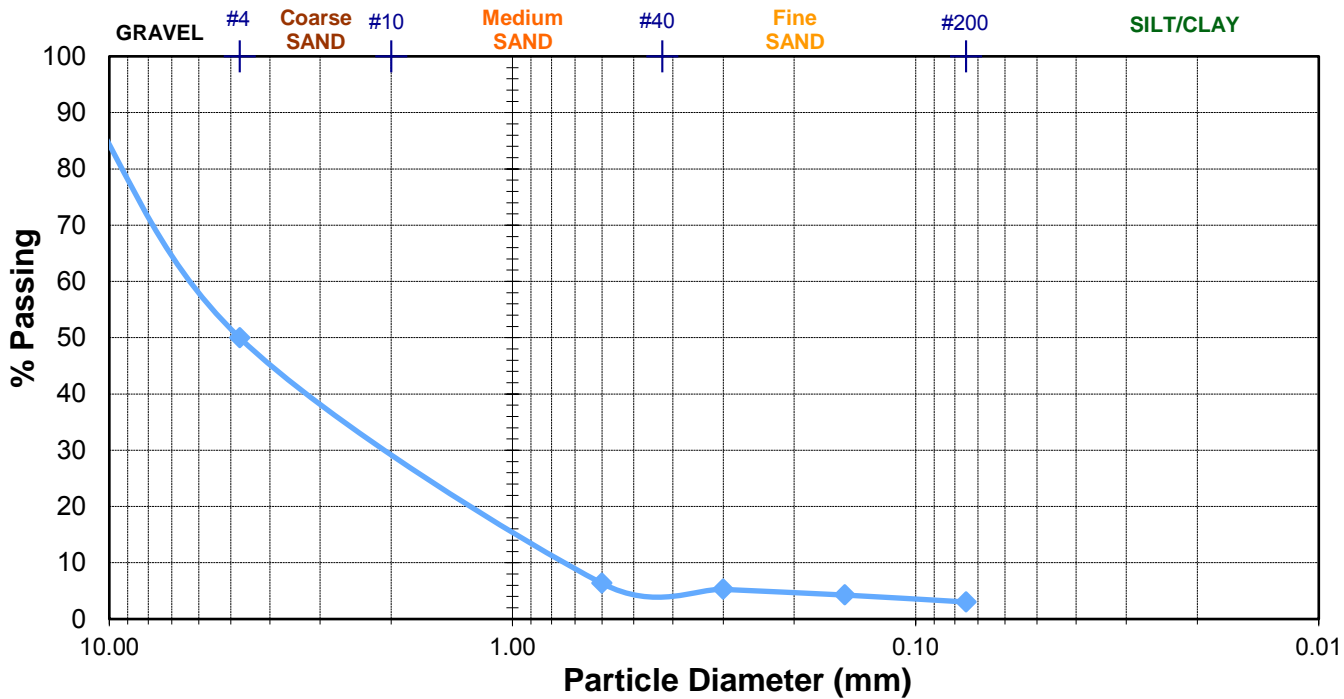

Grain Size Distribution Curve Results:

% Gravel:	<u>2.6</u>	D ₁₀ :	<u>0.72</u>	C _u :	<u>8.61</u>
% Sand:	<u>94.4</u>	D ₃₀ :	<u>2.05</u>	C _c :	<u>0.94</u>
% Fines:	<u>3</u>	D ₆₀ :	<u>6.2</u>		

Sieve Analysis Data Sheet

ASTM D422-63(2007)

Project Name: _____ Tested By: RH & JB Date: 7/10/2018
 Location: _____ Checked By: _____ Date: _____
 Boring No: _____ Test Number: _____
 Sample Depth: _____ Gnd Elev.: _____

Biochar Type: Agrosorb

Weight of Container (g): 3.2 Weight of Container & Soil (g): 175.3
 Weight of Dry Sample (g): 172.1

Sieve Number	Diameter (mm)	Mass of Container (g)	Mass of Container & Soil (g)	Soil Retained (g)	Soil Retained (%)	Soil Passing (%)
0.5	12.70	1.5896	3.1261	1.5	0.9	99.1
4	4.75	1.5896	6.1437	4.6	2.7	96.4
30	0.60	3.1792	104.6093	101.4	59.6	36.9
50	0.30	1.5896	24.1144	22.5	13.2	23.6
100	0.15	1.5896	20.3184	18.7	11.0	12.7
200	0.075	1.5896	13.1978	11.6	6.8	5.8
Pan		1.5896	11.5284	9.9	5.8	0.0
TOTAL:				170.3	100.0	

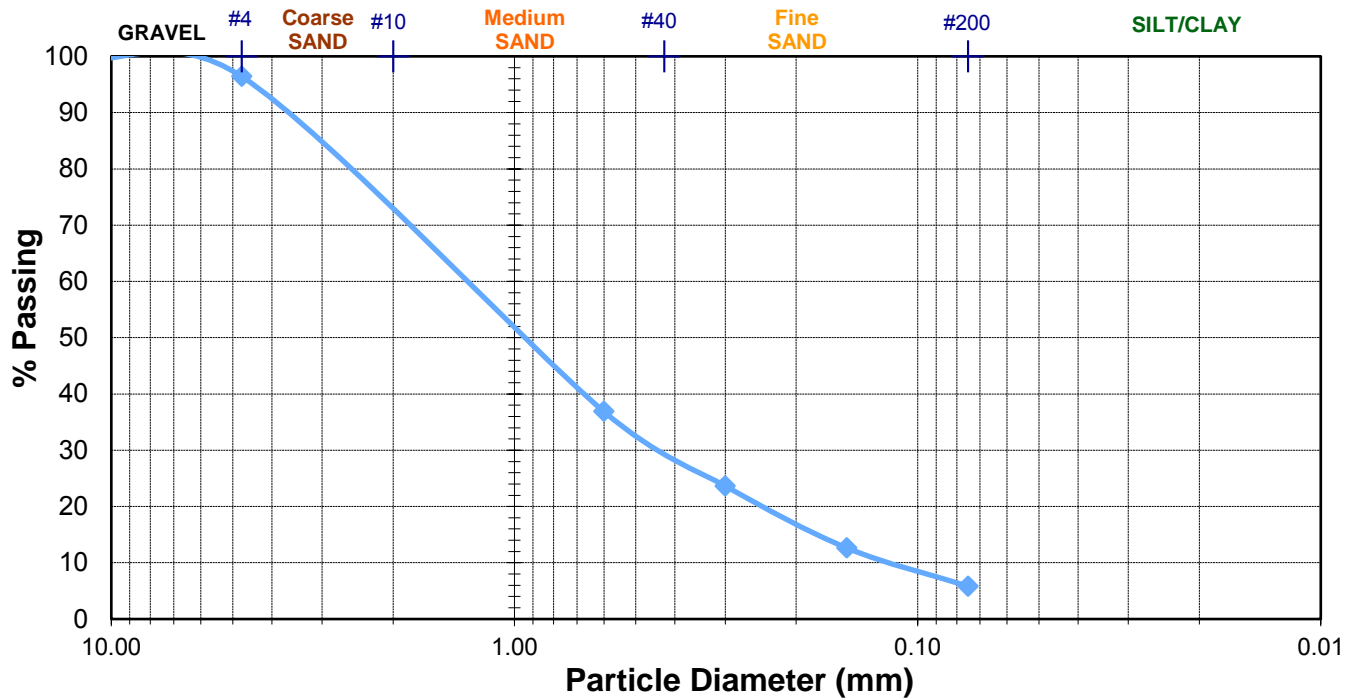

Grain Size Distribution Curve Results:

% Gravel: 0.9 D₁₀: 0.11 C_u: 10.9
 % Sand: 93.3 D₃₀: 0.43 C_c: 1.40
 % Fines: 5.8 D₆₀: 1.2

Sieve Analysis Data Sheet

ASTM D422-63(2007)

Project Name: _____ Tested By: RH & JB Date: 7/10/2018
 Location: _____ Checked By: _____ Date: _____
 Boring No: _____ Test Number: _____
 Sample Depth: _____ Gnd Elev.: _____

Biochar Type: Phoenix

Weight of Container (g): 2.8 Weight of Container & Soil (g): 241.2
 Weight of Dry Sample (g): 238.4

Sieve Number	Diameter (mm)	Mass of Container (g)	Mass of Container & Soil (g)	Soil Retained (g)	Soil Retained (%)	Soil Passing (%)
0.5	12.70	0.7018	0.7018	0.0	0.0	100.0
4	4.75	0.7018	23.5505	22.8	9.0	91.0
30	0.60	13.9837	122.8911	108.9	43.0	48.0
50	0.30	1.5896	33.2888	31.7	12.5	35.5
100	0.15	1.5896	32.0522	30.5	12.0	23.5
200	0.075	1.5896	28.2517	26.7	10.5	13.0
Pan		1.5896	34.4933	32.9	13.0	0.0
TOTAL:				253.5	100.0	

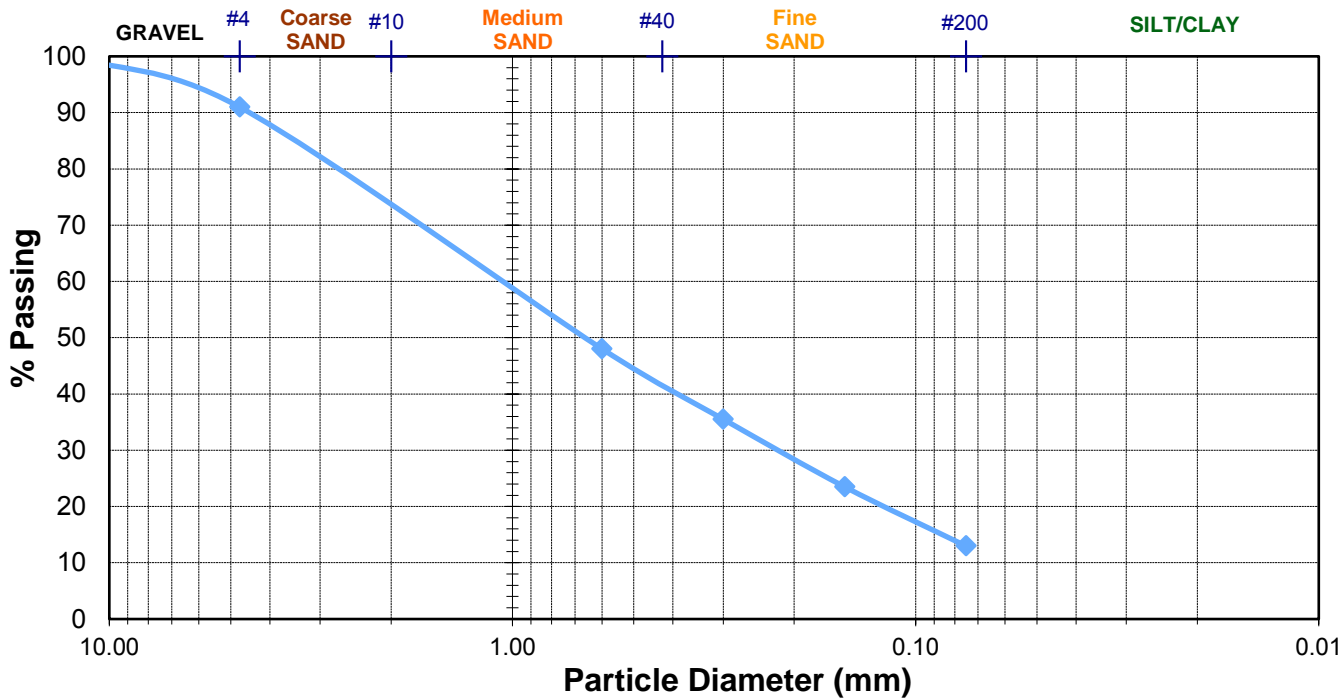

Grain Size Distribution Curve Results:

% Gravel: 0 D₁₀: _____ C_u: _____
 % Sand: 87 D₃₀: 0.21 C_c: _____
 % Fines: 13 D₆₀: 1.03

Sieve Analysis Data Sheet

ASTM D422-63(2007)

Project Name: _____ Tested By: RH & JB Date: 7/10/2018
 Location: _____ Checked By: _____ Date: _____
 Boring No: _____ Test Number: _____
 Sample Depth: _____ Gnd Elev.: _____

Biochar Type: Rogue

Weight of Container (g): 52.3 Weight of Container & Soil (g): 173.8
 Weight of Dry Sample (g): 121.5

Sieve Number	Diameter (mm)	Mass of Container (g)	Mass of Container & Soil (g)	Soil Retained (g)	Soil Retained (%)	Soil Passing (%)
0.5	12.70	1.5896	1.5896	0.00	0.00	100.00
4	4.75	1.5896	1.9089	0.32	0.27	99.73
30	0.60	3.1792	119.5292	116.35	97.79	1.94
50	0.30	1.5896	3.8304	2.24	1.88	0.05
100	0.15	1.5896	1.6583	0.07	0.06	0.00
200	0.075	1.5896	1.6115	0.02	0.02	-0.02
Pan		1.5896	1.5635	-0.03	-0.02	0.00
TOTAL:				119.0	100.0	

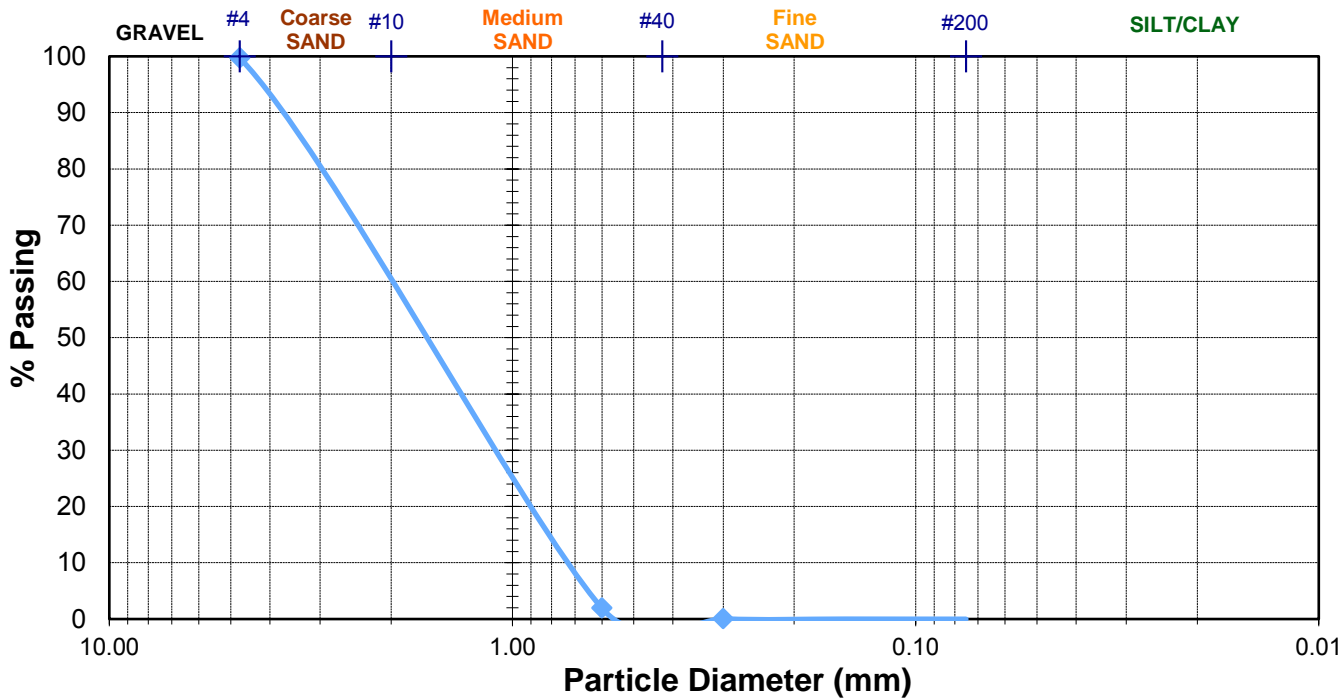

Grain Size Distribution Curve Results:

% Gravel: _____ D₁₀: _____ C_u: _____
 % Sand: _____ D₃₀: _____ C_c: _____
 % Fines: _____ D₆₀: _____

Sieve Analysis Data Sheet

ASTM D422-63(2007)

Project Name: _____ Tested By: RH & JB Date: 7/10/2018
 Location: _____ Checked By: _____ Date: _____
 Boring No: _____ Test Number: _____
 Sample Depth: _____ Gnd Elev.: _____

Biochar Type: Sun River

Weight of Container (g): 52.3 Weight of Container & Soil (g): 153.2
 Weight of Dry Sample (g): 100.9

Sieve Number	Diameter (mm)	Mass of Container (g)	Mass of Container & Soil (g)	Soil Retained (g)	Soil Retained (%)	Soil Passing (%)
0.5	12.70	1.5896	2.4228	0.8	0.8	99.2
4	4.75	1.5896	10.6182	9.0	9.0	90.2
30	0.60	1.5896	70.5872	69.0	68.7	21.5
50	0.30	1.5896	9.8777	8.3	8.2	13.3
100	0.15	1.5896	8.2566	6.7	6.6	6.6
200	0.075	1.5896	5.3083	3.7	3.7	2.9
Pan		1.5896	4.5286	2.9	2.9	0.0
TOTAL:				100.5	100.0	

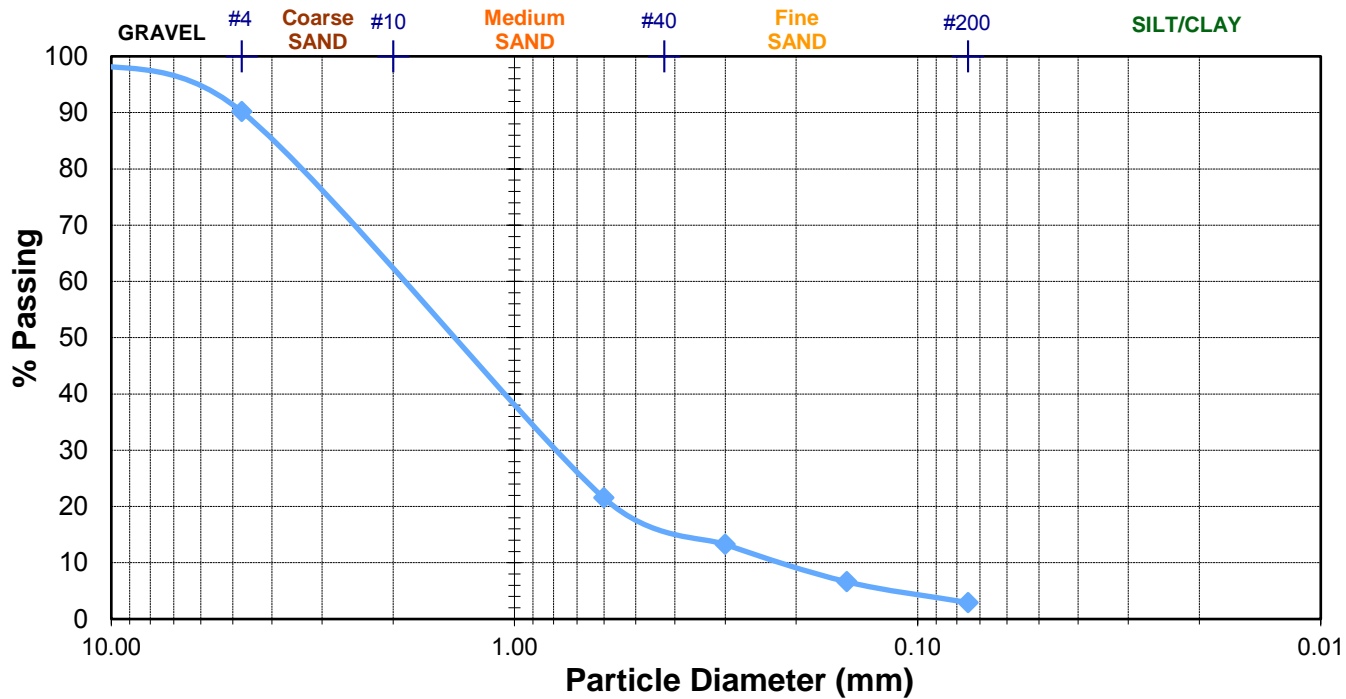

Grain Size Distribution Curve Results:

% Gravel:	<u>0.8</u>	D ₁₀ :	<u>0.22</u>	C _u :	<u>8.18</u>
% Sand:	<u>96.3</u>	D ₃₀ :	<u>0.78</u>	C _c :	<u>1.54</u>
% Fines:	<u>2.9</u>	D ₆₀ :	<u>1.8</u>		

Appendix E: Biochar Particle Size Distribution

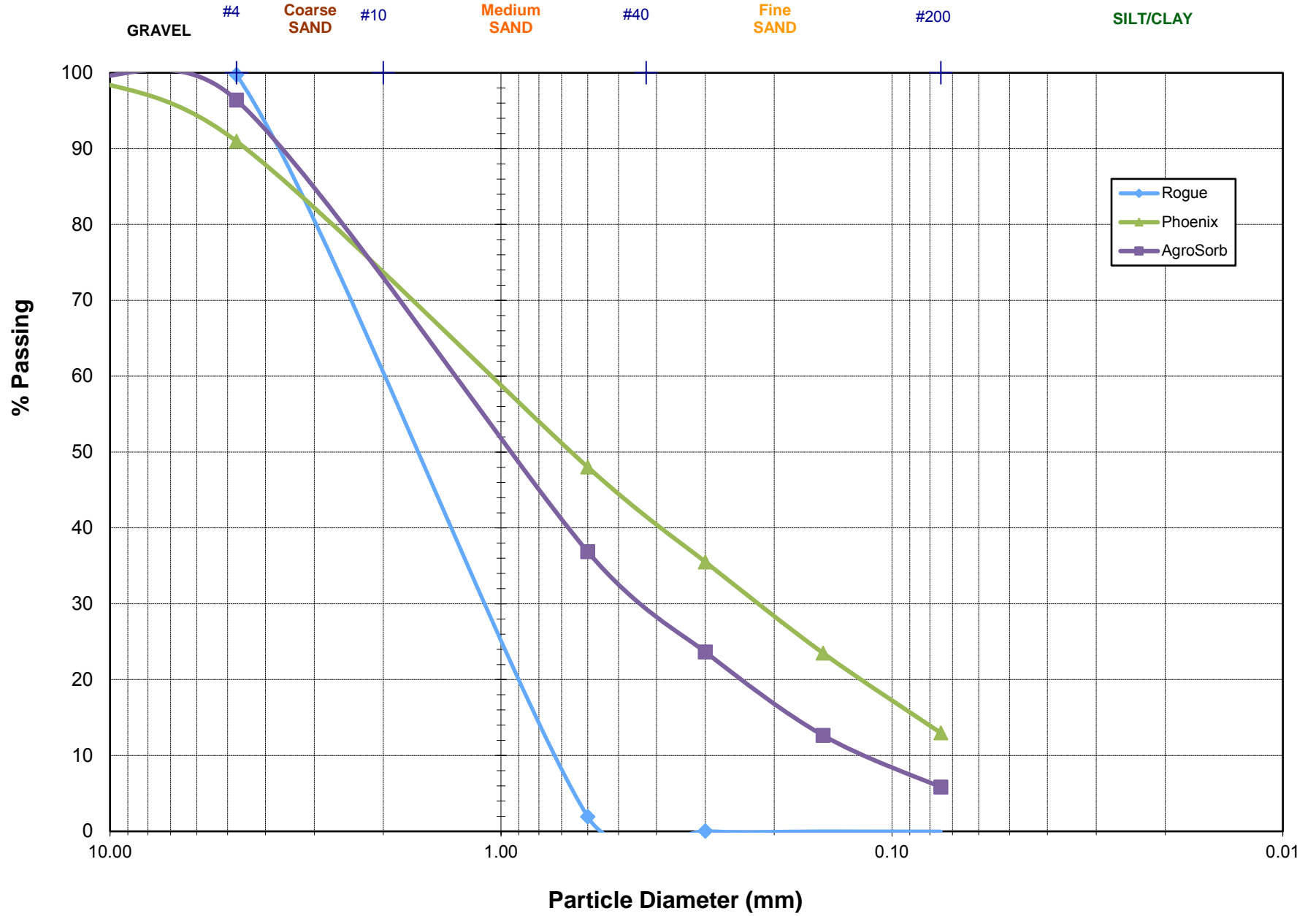

Appendix E: Biochar Particle Size Distribution

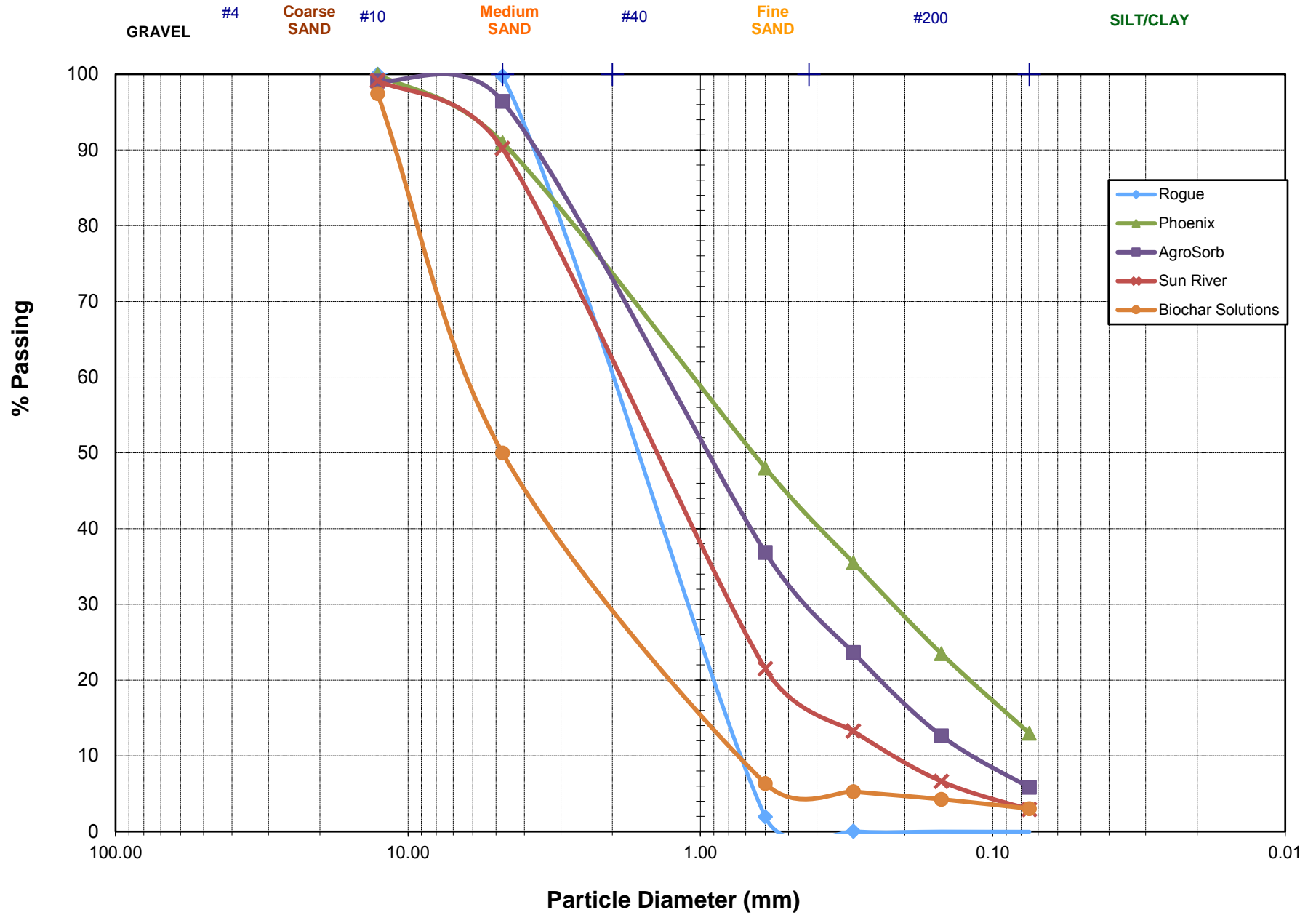

APPENDIX F: COLUMN TEST OBSERVATION FORMS

4/10/18 First Run

Stormwater Column Tests – Office of Water Programs

Sampling Run			
Date (mm/dd/yy):	Time (24 hr) :	Team Member's Initials:	Column ID: CO

During Test - Timed Measurements

Time	Water Depth	Media Condition	Other Observations

Grab Sample - Beginning of Run

Time	Water Depth	Turbidity (NTU)	Temp	pH	Other Observations
4:25	1"	20.6			

Grab Sample - Middle of Run

Time	Water Depth	Turbidity (NTU)	Temp	pH	Other Observations
5:49	1"	18.7			

Grab Sample - End of Run

Time	Water Depth	Turbidity (NTU)	Temp	pH	Other Observations

Grab Sample - Mercury

Time	Water Depth	Turbidity (NTU)	Temp	pH	Other Observations

Stormwater Column Tests – Office of Water Programs

Sampling Run			
Date (mm/dd/yy):	Time (24 hr) :	Team Member's Initials:	Column ID: <i>CO2</i>

During Test - Timed Measurements

Time	Water Depth	Media Condition	Other Observations

Grab Sample - Beginning of Run

Time	Water Depth	Turbidity (NTU)	Temp	pH	Other Observations
<i>4:28</i>	<i>1'</i>	<i>210</i>			

Grab Sample - Middle of Run

Time	Water Depth	Turbidity (NTU)	Temp	pH	Other Observations
<i>5:49</i>	<i>1'</i>	<i>206</i>			

Grab Sample - End of Run

Time	Water Depth	Turbidity (NTU)	Temp	pH	Other Observations

Grab Sample - Mercury

Time	Water Depth	Turbidity (NTU)	Temp	pH	Other Observations

Stormwater Column Tests – Office of Water Programs

Sampling Run			
Date (mm/dd/yy):	Time (24 hr) :	Team Member's Initials:	Column ID: <i>COS</i>

During Test - Timed Measurements

Time	Water Depth	Media Condition	Other Observations

Grab Sample - Beginning of Run

Time	Water Depth	Turbidity (NTU)	Temp	pH	Other Observations
<i>4:26</i>	<i>11"</i>	<i>138</i>			

Grab Sample - Middle of Run

Time	Water Depth	Turbidity (NTU)	Temp	pH	Other Observations
<i>5:01</i>	<i>4"</i>	<i>181</i>			

Grab Sample - End of Run

Time	Water Depth	Turbidity (NTU)	Temp	pH	Other Observations

Grab Sample - Mercury

Time	Water Depth	Turbidity (NTU)	Temp	pH	Other Observations

Stormwater Column Tests – Office of Water Programs

Sampling Run			
Date (mm/dd/yy):	Time (24 hr) :	Team Member's Initials:	Column ID: <i>CAF</i>

During Test - Timed Measurements

Time	Water Depth	Media Condition	Other Observations

Grab Sample - Beginning of Run

Time	Water Depth	Turbidity (NTU)	Temp	pH	Other Observations
<i>4:21</i>	<i>0"</i>	<i>289</i>			

Grab Sample - Middle of Run

Time	Water Depth	Turbidity (NTU)	Temp	pH	Other Observations
<i>5:42</i>	<i>1"</i>	<i>212</i>			

Grab Sample - End of Run

Time	Water Depth	Turbidity (NTU)	Temp	pH	Other Observations

Grab Sample - Mercury

Time	Water Depth	Turbidity (NTU)	Temp	pH	Other Observations

Stormwater Column Tests – Office of Water Programs

Sampling Run			
Date (mm/dd/yy):	Time (24 hr) :	Team Member's Initials:	Column ID: <i>cos</i>

During Test - Timed Measurements

Time	Water Depth	Media Condition	Other Observations

Grab Sample - Beginning of Run

Time	Water Depth	Turbidity (NTU)	Temp	pH	Other Observations
<i>4:31</i>	<i>2"</i>	<i>283</i>			

Grab Sample - Middle of Run

Time	Water Depth	Turbidity (NTU)	Temp	pH	Other Observations
<i>5:02</i>	<i>2"</i>	<i>234</i>			

Grab Sample - End of Run

Time	Water Depth	Turbidity (NTU)	Temp	pH	Other Observations

Grab Sample - Mercury

Time	Water Depth	Turbidity (NTU)	Temp	pH	Other Observations

Stormwater Column Tests – Office of Water Programs

Sampling Run			
Date (mm/dd/yy):	Time (24 hr) :	Team Member's Initials:	Column ID: <i>CO6</i>

During Test - Timed Measurements

Time	Water Depth	Media Condition	Other Observations

Grab Sample - Beginning of Run

Time	Water Depth	Turbidity (NTU)	Temp	pH	Other Observations
<i>12:45</i>	<i>1"</i>	<i>212</i>			

Grab Sample - Middle of Run

Time	Water Depth	Turbidity (NTU)	Temp	pH	Other Observations
<i>5:55</i>	<i>3"</i>	<i>335</i>			

Grab Sample - End of Run

Time	Water Depth	Turbidity (NTU)	Temp	pH	Other Observations

Grab Sample - Mercury

Time	Water Depth	Turbidity (NTU)	Temp	pH	Other Observations

Stormwater Column Tests – Office of Water Programs

Sampling Run			
Date (mm/dd/yy):	Time (24 hr) :	Team Member's Initials:	Column ID: <i>EN Flow 7</i>

During Test - Timed Measurements

Time	Water Depth	Media Condition	Other Observations

Grab Sample - Beginning of Run

Time	Water Depth	Turbidity (NTU)	Temp	pH	Other Observations
<i>4:18</i>	<i>-</i>	<i>29.</i>			

Grab Sample - Middle of Run

Time	Water Depth	Turbidity (NTU)	Temp	pH	Other Observations
<i>5:56</i>	<i>-</i>	<i>26.4</i>			

Grab Sample - End of Run

Time	Water Depth	Turbidity (NTU)	Temp	pH	Other Observations

Grab Sample - Mercury

Time	Water Depth	Turbidity (NTU)	Temp	pH	Other Observations

Column Description Influent

Sample Run 1

Water 2-2

Dose	Time	Height of water (in)	Temp (C)	Turbidity (NTU)
1	X			
2	X			
3	X	→ Start of Sampling		
4	X			
5	X			
6	X			
7	X			
8	3:46			
9	3:58			
10	4:18	turb		
11	4:46			
12	5:08			
13	6:09			
14	X			
15	5:36			
16	5:00			
17	5:46			
18	5:55			

Observations:

Technician _____

Column ID: CO2 Date: 4/10/18

Column Description Rogue

Dose	Time	Height of water (in)	Temp (C)	Turbidity (NTU)
1	3:45			
2	3:48			
3	3:20			
4	3:21			
5	3:30			
6	3:34			
7	3:41			
8	3:44			
9	3:48			
10	4:15			
11	4:20	Turb		
12	4:42			
13	4:50	Mercury		
14	5:21			
15	5:31			
16	5:31	.5?		
17	5:41			
18	5:51			

Observations:

Column Description

Sun River

Dose	Time	Height of water (in)	Temp (C)	Turbidity (NTU)
1	2:45			
2	2:48			
3	3:19			
4	3:26	Stop 4 hrs starting		
5	3:30	4" → dry before next hour		
6	3:33	2 1/4"		
7	3:40	3 1/2"		
8	3:46	5 1/2"		
9	3:47	2 1/2" → dry before next hour		
10	4:15			
11	4:19	90%h		
12	4:41			
13	4:48	Mercury grab		
14	5:20			
15	5:30			
16	5:36	1 1/2"		
17	5:40			
18	5:50			

Observations:

Technician _____

Column ID: C03

Date: 4/10/18

Column Description Phoenix

Dose	Time	Height of water (in)	Temp (C)	Turbidity (NTU)
1	2:45			
2	2:49			
3	3:20	Ponding		
4	3:27			
5	3:30	1.5"		
6	2:34	2.0"		
7	3:41	2.0"		
8	3:45	2.5"		
9	3:49	2.75"		
10	4:15	1"		
11	4:20	1.5"	Turb	
12	4:43	1"		
13	4:52	Mercury		
14	5:25	1"		
15	5:32	1"		
16	5:38	1"		
17	5:41	1.5"		
18	5:51			

Observations:

Column Description Biochar Solutions

Dose	Time	Height of water (in)	Temp (C)	Turbidity (NTU)
1	3:45			
2	3:49			
3	3:21			
4	3:28			
5	3:31	1"		
6	3:34	1.5"		
7	3:42	1"		
8	3:45	1.5"		
9	3:50	2"		
10	4:16	2.5"		
11	4:21	turb		
12	4:44	5"		
13	4:58	increasing		
14	5:26	1"		
15	5:33	1.5"		
16	6:30			
17	5:42	2"		
18	5:57			

Observations:

Column Description Black Sorb

Dose	Time	Height of water (in)	Temp (C)	Turbidity (NTU)
1	2:45			
2	2:50			
3	3:22	Knocking		
4	3:28	1"		
5	3:31	1.25		
6	3:34	2.75"		
7	3:42	1.5		
8	3:46	2"		
9	3:50	2.75		
10	4:17	1"		
11	4:22	1.5"	Turb	
12	4:44	1"		
13	5:02	1"		
14	5:26	.75"		
15	5:34	1.5"		
16	5:39			
17	5:43	3"		
18	5:53	1.5"		

Observations:

Column Description Control

Dose	Time	Height of water (in)	Temp (C)	Turbidity (NTU)
1	2:45			
2	2:51			
3	3:20	Yanked		
4	3:28			
5	3:32	1.75"		
6	3:35	2.5"		
7	3:43	2.75"		
8	3:46	3.5"		
9	3:50	1"		
10	4:18	1.75"		
11	4:22	2"	Turb → dropped	for 0" before next sample
12	4:45	1"		
13	5:03	1"		
14	5:29	1"		
15	5:34	1.5"		
16	5:40			
17	5:44	2.5"		
18	5:50	3.5"		

Observations:

Column Description

media flushing w/ 2-2 & 2-1

Dose	Time	Height of water (in)	Temp (C)	Turbidity (NTU)
1	1:06	1		
2	/	1		
3	/	1		
4	/	2		
5	/	2.5		
6	/	2		88.5
7	2:02	1		
8	/	2		
9	/	2.5		
10	/	3		
11	/	4		
12	/	5		
13	/	3.5		
14	3:08	1		
15	/	2		
16	/	2.5		
17	3:31	2.5		
18	3:40	2		155

site 2 storm 1

Break @ 2:35

Mix of 2-1 & 2-2 half dose

Observations:

Column Description

Media Flushing w/ 2-2

Dose	Time	Height of water (in)	Temp (C)	Turbidity (NTU)
1	1:05	0		
2	/	1		
3	/	1		
4	/	1.5		
5	/	2		
6	/	2		91.1
7	2:01	1		
8	/	2		
9	/	2.5		
10	/	3		
11	/	4		
12	/	4.5		
13	/	3		
14	3:07	0		
15	/	1		
16	/	2		
17	3:29	1		
18	3:39	0		160

Site 2 Storm 1

Break @ 2:35

Mix of 2-1 & 2-2 half dose

19
 Observations: ~~X~~

Technician Michelle

Column ID: 4

Date: 4/11/18

Column Description

Media Flushing w/ 2-2

Dose	Time	Height of water (in)	Temp (C)	Turbidity (NTU)
1	1:04	0		
2	/	1		
3	/	1		
4	/	1		
5	/	1		
6	/	1		105
7	2:00	1		
8	/	1.5		
9	/	2.5		
10	/	3		
11	/	4		
12	/	5		
13	/	5		
14	3:00	1		
15	/	1.5		
16	/	2		
17	3:28	1		
18	3:38	0.5		122

site 2 storm 1

Break @ 2:35

Mix of 2-1 & 2-2
half dose

Observations: X

Technician Michelle

Column Description

Media Filling v/2-2

Dose	Time	Height of water (in)	Temp (C)	Turbidity (NTU)
1	12:56	0		
2	/	1		
3	/	1		
4	/	1.5		
5	/	1.5		
6	/	1		25.4
7	2:00	1		
8	/	1.5		
9	/	2.5		
10	/	3		
11	/	4		
12	/	5		
13	/	5		
14	3:05	1		
15	/	1.5		
16	/	2.5		
17	3:27	2		
18	3:38	1.5		96.1

Site 2 storm 1

Break @ 2:35

Mix of 2-1 & 2-2 half dose

Observations: ~~✓~~

Technician Michelle

Column Description

2-2 Flushing w/ 2-2

Dose	Time	Height of water (in)	Temp (C)	Turbidity (NTU)
1	12:35	0		
2	/	1		
3	/	1		
4	/	1		
5	/	1		
6	/	1		105
7	1:59	1		
8	/	1		
9	/	2		
10	/	2.5		
11	/	3		
12	/	4		
13	/	4		
14	3:05	1		
15	/	1		
16	/	1		
17	3:27	1		
18	3:37	0		143

Site 2 storm 1

Break @ 2:35

Mix of 2-1 & 2-2
half dose

Observations: X

Technician Michelle

Column ID: 1

Date: 9/11/18

Column Description

Media Flushing w/ 2-2 Site 2 Storm 2

Dose	Time	Height of water (in)	Temp (C)	Turbidity (NTU)
1	12:54	0		
2	/	0		
3	/	0		
4	/	0		
5	/	0		
6	/	0		87.5
7	1:58	0		
8	/	0		
9	/	0		
10	/	0		
11	/	0		
12	/	0		
13	/	0		
14	2:05	0		
15	/	0		
16	/	0		
17	2:25	0		
18	2:34	0		98.5 102

Site 2 Storm 1

Break @ 2:35

Mix of 2-1 & 2-2 half dose

Observations:

Column Description Media Flushing

Dose	Time	Height of water (in)	Temp (C)	Turbidity (NTU)
1	12:45			
2	12:45			
3	/	1		
4	/	2		
5	/	2.2		
6	1:14	2.8		16.5
7	1:33	1.9		
8	/	2.8		
9	/	3		
10	/	4		
11	/	4.4		21.6
12	2:31	2		
13	-	1		
14	-	1		
15	-	2		
16	-	2.4		
17	-	2.4		
18	3:14	4		47.7

USDA

Observations:

Technician Jessica/Audrey

Column ID: 002 Date: 4/8/18

Column Description

Dose	Time	Height of water (in)	Temp (C)	Turbidity (NTU)
1	12:45			
2	/	1		
3	/	1.5		
4	/	2.2		
5	/	2.5		
6	1:15	3		15.4
7	1:34	2		
8	/	2.2		
9	/	1.5		
10	/	4		
11	/	4.3		28.3
12	2:31			
13	-	1.75		
14	-	2.5		
15	-	3.4		
16	-	4.0		
17	-	4.9		
18	3:14	4		45.6

BREAK

Observations:

Technician Jessica Aubrey

Column ID: C03

Date: 9/11/18

Column Description

Dose	Time	Height of water (in)	Temp (C)	Turbidity (NTU)
1	12:45			
2	/	1		
3	/	1		
4	/	1		
5	/	1.5		
6	1:15	1.6		34.4
7	1:34	1		
8	/	1.8		
9	/	1.5		
10	/	1.8		
11	/	2.2		61.1
12	2:31	1		
13	-	1.5		
14	-	2		
15	-	3		
16	-	3.4		
17	-	3.4		
18	3:14	1.7		63.7

BREAK

Observations:

Technician Jessica/Andrew

Column Description

Dose	Time	Height of water (in)	Temp (C)	Turbidity (NTU)
1	12:45			
2	/			
3	/	1		
4	/	1.2		
5	/	1.7		
6	1:16	2		33.1
7	1:36	2		
8	/	1.2		
9	/	2		
10	/	2.5		
11	/	2.9		48.0
12	2:32	-		
13	-	1		
14	-	1.3		
15	-	2		
16	-	2.8		
17	-	2.8		
18	3:14	1		67.2

BREAK

Observations:

Technician Jessica Andrey

Column ID: C05

Date: 9/10/18

Column Description

Dose	Time	Height of water (in)	Temp (C)	Turbidity (NTU)
1	12:45			
2	/			
3	/	1.5		
4	/	2		
5	/	2.0		
6	1:10	3.3		32.4
7	1:36	2		
8	/	2.5		
9	/	3		
10	/	3.3		
11	/	4.2		40.3
12	2:32	←		
13	—	1.2		
14	—	1.0		
15	—	2.3		
16	—	2.5		
17	—	3		
18	3:15	1		80.5

BRITN

Observations:

Technician Jessica/Audrey

Column ID: 106 Date: 4/11/18

Column Description

Dose	Time	Height of water (in)	Temp (C)	Turbidity (NTU)
1	12:45			
2	/	1		
3	/	1.5		
4	/	1.75		
5	/	2		
6	1:17	2.75		29.3
7	1:37	1		
8	/	1.5		
9	/	2.1		
10	/	3		
11	1:53	3.6		76.5
12	2:32	1		
13	-	1.75		
14	-	2		
15	-	3		
16	-	3.5		
17	-	4		
18	-	2.8		102

- BR. EPK

Observations:

Technician Joe L

Sampling Sheet
Appendix F: Column Test Observation Forms

Column ID: Inf Date: 4/13/18

Column Description

Sample Run 2

Dose	Time	Height of water (in)	Temp (C)	Turbidity (NTU)
1	9:05			
2	9:10			✓
3	9:30			
4	9:40		21	
5	9:48			
6	9:57			
7	10:30			
8	10:37			
9	10:42			✓
10	10:56			
11	11:58			
12	11:49			
13	11:53			
14	11:57			
15	12:01			
16	12:03			
17	12:09			
18	12:12		20°C	

→ pending

Observations: pH: 6.80 Temp: 20.2°C

Technician J. J. 1

Column Description

Dose	Time	Height of water (in)	Temp (C)	Turbidity (NTU)
1	9:03			
2	9:08			✓
3	9:21			
4	9:38			
5	9:46			
6	9:49	.5-1		
7	10:20			
8	10:31			
9	10:40			✓
10	10:46			
11	11:15			
12	11:42			
13	11:50			
14	11:55			
15	12:00			
16	12:59			
17	1:04			
18	1:11	1.25		

no pumping

Observations: 19.20C & pH=7.66

Technician Zep

Column Description

Dose	Time	Height of water (in)	Temp (C)	Turbidity (NTU)
1	9:05			
2	9:09	1"		Stopped draining, no Turb Sample
3	9:27	1.25"		✓
4	9:38	2"		
5	9:46	2.75"		
6	9:49	3.25"		
7	10:29	1.1"		
8	10:35	1.75"		
9	10:40	2.5"		✓
10	10:49	2.75"		
11	11:30	-		
12	11:42			
13	11:50			
14	11:55			
15	12:00			
16	1:00			
17	1:05	1.5"		
18	1:17	2.25"		

Stopped draining, no Turb Sample

→ removed 3 screws → flow started again

→ pending

Observations: Very slow 145 rpm, Very clear effluent

pH=7.97 Temp=19.20C

Technician JDP

Appendix F: Column Test Observation Forms

Sampling Sheet

Column ID: 03

Date: 4/13/18

Co3

Column Description

Dose	Time	Height of water (in)	Temp (C)	Turbidity (NTU)
1	9:04			
2	9:09			✓
3	9:28			
4	9:39	1.11		
5	9:47	1.25"		
6	9:49	1.75		
7	10:31			
8	10:35	?		
9	10:41	1.75		↙
10	10:50	2.1		
11	11:31			
12	11:43			
13	11:51			
14	11:55			
15	12:00			
16	1:09			
17	1:04	1.25"		
18	1:13	1.75"		

→ pending

Observations:

pH = 7.65

Temp: 19.2°C

Technician J. P. 1

Column Description

Dose	Time	Height of water (in)	Temp (C)	Turbidity (NTU)
1	9:01			
2	9:09			✓
3	9:28			
4	9:39	0.75		
5	9:48	-?		
6	9:49	1.5		
7	10:31			
8	10:52			
9	10:41	1		✓
10	10:53	1.1		
11	11:32			
12	11:43			
13	11:51			
14	11:56			
15	12:02			
16	1:01			
17	1:06			
18	1:11	1.25		

→ ponding

Observations: pH = ~~7.78~~ 7.78 temp: 19.2°C

Technician Joe

Column Description

Dose	Time	Height of water (in)	Temp (C)	Turbidity (NTU)
1	9:00			
2	9:10			✓
3	9:28			
4	9:40			
5	9:48	2"		
6	9:50	1.75		
7	10:31			
8	10:36	1"		
9	10:48	1.75		✓
10	10:55	1.75		
11	11:35			
12	11:44			
13	11:52			
14	11:56			
15	12:04			
16	1:02			
17	1:07	1"		
18	1:15	2"		

→ remove 3 screws

→ Ponding

Observations: pH = 7.77 Temp = 19.5°C

Technician Jre-l

Column Description

Dose	Time	Height of water (in)	Temp (C)	Turbidity (NTU)
1	9:14			
2	9:10			✓
3	9:29			
4	9:40	0.75"		
5	9:48	1.5"		
6	9:50	2"		
7	10:32			
8	10:36	1"		
9	10:42	1.5"		✓
10	10:56	1.5"		
11	11:36			
12	11:49			
13	11:53			
14	11:57			
15	12:03			
16	1:03			
17	1:08	1"		
18	1:16	1.5"		

Observations: pH: 7.94 Temp: 19.5°C

Technician Joel

Column ID: COL

Date: 4/17/18

Column Description

Sample Run 3

Dose	Time	Height of water (in)	Temp (C)	Turbidity (NTU)
1	10:14			
2	10:16			
3	10:20	0.50		10.5
4	10:36			
5	10:45			
6	11:27			
7	11:32	0.50		
8	11:35	1.25		
9	11:40	1.75	✓	✓
10	12:18			
11	12:25	0.75		
12	12:35	1.25		
13	12:39	2.25		
14	12:47	2.75		
15	12:58	3.50		
16	1:03	4.25		
17	1:02	4.00		
18	1:06	4.50		

12

20

Observations:

Technician Juel

Column ID: CO2 Date: 4/17/18

Column Description

Dose	Time	Height of water (in)	Temp (C)	Turbidity (NTU)
1	10:14	0.25		
2	10:16	0.75		
3	10:20	1.5		
4	10:36	1.75		
5	10:45	2.50		2.27
6	11:27	0.75		
7	11:32	1.5		
8	11:35	2.25		
9	11:41	2.75	✓	✓
10	12:10	1.50		
11	12:25	2.00		
12	12:36	2.50		
13	12:39	3.25		
14	12:47	3.75		
15	12:50	4.00		
16	12:54	5.25		
17	1:02	5.25		
18	1:06	5.75		

4

21

Observations:

Technician Joel

Column ID: C03 Date: 4/17/18

Column Description

Dose	Time	Height of water (in)	Temp (C)	Turbidity (NTU)
1	10:14			
2	10:17			
3	10:20	0.25		14.5
4	10:42			
5	10:45			
6	11:27			
7	11:33	0.50		
8	11:35	1.00		
9	11:42	1.25		/
10	12:18			
11	12:25	0.25		
12	12:36	0.50		
13	12:40	1.50		
14	12:47	2.50		
15	12:50	3.50		
16	12:54	4.00		
17	1:03	3.75		
18	1:06	4.50		

27

57

Observations:

Technician Seel

Column ID C04 Date: 4/17/18

Column Description

Dose	Time	Height of water (in)	Temp (C)	Turbidity (NTU)
1	10:15			
2	10:17	0.25		
3	10:20	0.50		8.02
4	10:42			
5	10:46	0.50		
6	11:28	0.25		
7	11:33	0.75		
8	11:36	1.75		
9	11:40	2.00	✓	✓
10	12:19	0.25		
11	12:26	0.50		
12	12:37	0.75		
13	12:40	1.75		
14	12:48	2.25		
15	12:50	3.00		
16	12:54	3.75		
17	1:03	4.00		
18	1:07	4.75		

14

36

Observations:

Technician Joel

Column Description

Dose	Time	Height of water (in)	Temp (C)	Turbidity (NTU)
1	10:15			
2	10:18	0.5		
3	10:21	1		6.27
4	10:42			
5	10:46	0.50		
6	11:28			
7	11:33	0.25		
8	11:36	0.75		
9	11:44	0.75	✓	✓
10	12:19	0.25		
11	12:26	0.50		
12	12:37	1.00		
13	12:40	1.75		
14	12:48	2.25		
15	12:50	3.00		
16	12:55	4.00		
17	1:03	4.00		
18	1:07	4.50		

22

22

Observations:

Technician Joel

Column ID: 06

Date: 9/17/18

Column Description

Dose	Time	Height of water (in)	Temp (C)	Turbidity (NTU)
1	10:15			
2	10:18	0.25		
3	10:21	0.25		11.7
4	10:43			
5	10:46	0.50		
6	11:29	0.50		
7	11:34	1.00		
8	11:37	1.75		
9	11:45	2.00	✓	✓
10	12:19	0.50		
11	12:27	0.50		
12	12:38	0.75		
13	12:40	1.75		
14	12:48	2.25		
15	12:52	3.00		
16	12:55	4.00		
17	1:04	4.00		
18	1:07	4.75		

280

60

Observations:

Technician Jed

Column ID: INF TW6

Date: 4/17/18

Column Description

Storm 2

Dose	Time	Height of water (in)	Temp (C)	Turbidity (NTU)
1	10:15			
2	10:18			
3	10:22			5.51
4	10:43			
5	10:46			
6	10:28			
7	11:34			
8	11:37			
9	11:41		✓	✓
10	12:20			
11	12:38			
12	12:40			
13	12:48			
14	12:52			
15	12:55			
16	1:04			
17	1:08			
18				

12:27 →
Shift down

Observations: Missed 12:27 time record
shift Dose 11 through Dose 17 down
one cell & insert 12:27 for Dose 11

Technician Joel

Column ID: TW2

Date: 4/19/18

Column Description

Dose	Time	Height of water (in)	Temp (C)	Turbidity (NTU)
1	9:41			
2	9:42			
3	9:46			
4	9:55			
5	9:56		✓	✓
6	10:15			
7	10:17			
8	10:19			
9	10:22			
10	10:24			
11	10:26		✓	✓
12	11:04			
13	11:05			
14	11:06			
15	11:07			
16	11:08			
17	11:10			
18	11:16			

J. Watson Run

Gage Run

Observations:

Technician Joel

Column ID: CO6

Date: 4/19/18

Column Description

Dose	Time	Height of water (in)	Temp (C)	Turbidity (NTU)
1	9:41			
2	9:43	0.5		
3	9:46	0.5		
4	9:54	0 0		
5	9:56	1.5	✓	✓
6	10:15	1.5		
7	10:16	1.5		
8	10:18	2.25		
9	10:22	3 0.03		
10	10:23	4		
11	10:26	5	✓	✓
12	11:04	1		
13	11:05	2		
14	11:06	2.5		
15	11:07	3.75		
16	11:08	4.85		
17	11:10	5.5		
18	11:16	5.8		

→ Start effluent collection

Grab Merc

Observations:

Technician Joel

Column ID: CO4

Date: 4/19/18

Column Description

Dose	Time	Height of water (in)	Temp (C)	Turbidity (NTU)
1	9:40			
2	9:42	1		
3	9:45	1.75		
4	9:54	2.0		
5	9:56	2.75	✓	✓
6	10:14	1		
7	10:15	2		
8	10:18	2.75		
9	10:21	3.5		
10	10:23	4.25		
11	10:25	5	✓	✓
12	11:04			
13	11:05	2		
14	11:06	2.75		
15	11:07	3.75		
16	11:08	4.75		
17	11:10	5.5		
18	11:16	5.9		

Start
→ Effluent Collection

Grab Sample

Observations:

4/19/18

FOC Columns

Sample ID	Turb	Time	pH	Temp
CO3 COC	13.6	10:02	6.99	18.7
CO4	6.46	10:03	7.09	19.3
CO6	7.75	10:06	6.96	18.9
Influent	2.02	10:10	7.63	19.1
CO1	9.75	10:29	6.89	19.4
CO6	13.8	10:34	7.08	19.2
Influent	1.93	10:36	7.77	19.3
CO6	21.8	11:18	6.55	19.1°C
CO4	21.7	11:22	6.93	19.2°C
Influent	2.08	11:24	7.68	18.8°C

Technician Joel S.

Appendix F: Column Test Observation Forms

Sampling Sheet

Column ID: JWF Date: 5/9/18

Column Description

TW2 influent

Retest

Dose	Time	Height of water (in)	Temp (C)	Turbidity (NTU)
1	10:02a			
2	10:03a			
3	10:04a			
4	10:05a			
5	10:17a			
6	10:18a			
7	10:19a			
8	10:20a			
9	10:29a			
10	10:30a			
11	10:31a			
12	10:32a			
13	10:41a			
14	10:42a			
15	10:43a			
16	10:45a			
17	10:46a			
18	10:50a			

replacement storm.
 2-1 used for majority of influent,
 2-2 mixed in for last part

→ Turb
 → Mercury Grab
 → Grab taken
 → Grab taken

Observations:

Column Description

Dose	Time	Height of water (in)	Temp (C)	Turbidity (NTU)
1	10:02a			
2	10:03a			
3	10:04a			
4	10:05a			✓
5	10:17a			
6	10:18a			
7	10:19a			
8	10:19a	3"		
9	10:29a			
10	10:29a			
11	10:31a	3.5		
12	10:32a			✓
13	10:41a			
14	10:42a			
15	10:43a			
16	10:45a			
17	10:46a			
18	10:50a	6"		

→ grab taken

→ Mercury grab

→ Grab taken

Observations:

4/13/18

OC

Influent

Sample	Turb / POC Column	Time
CO1	13.6	9:11
CO3	17.1	9:13
CO4	27.0	9:14
CO5	69.5	9:15
CO6	48.9	9:17
Influent	55.3	9:17
CO1	46.0	9:20
CO2	63.3	9:36

Round 2

CO1	59.8	10:44am
CO2	22.5	10:44am
CO3	52.3	10:46am
CO4	47.8	10:47am
CO5	54.0	10:51am
CO6	82.8	10:54am
Influent	13.2	10:55am

Round 3

CO1	56.9	1:14pm
CO2	74.3	1:20pm
CO3	84.2	1:21pm
CO4	82.4	1:22pm
CO5	81.9	1:23pm
CO6	122	1:24pm
Influent	18.0	

4/17/18

PCC Columns

Sample ID	Turb	Time	pH	temp
00C	13.6	9:47		
Turb	5.51	10:23am	6.10	19°C
C06	11.7	10:24am	6.86	19.2°C
C03	14.5	10:27am	7.01	19.1°C
C04	8.02	10:28am	6.83	19.3°C
C05	6.27	10:30am	7.05	18.9°C
C01	10.5	10:36am	6.95	19.2°C
C02 (Dose 5)	2.27	10:57am	7.26	18.1°C
<u>Round 2</u> (Dose 4)				
Turb	7.95	11:46am	6.04	20.1°C
C01	13.0	11:56am	6.88	19.4°C
C02	4.05	12:04pm	7.23	19.3°C
C03	27.6	11:58am	6.98	19.1°C
C04	14.9	12:01pm	7.16	19.2°C
C05	22.8	12:11pm	7.02	19.1°C
C06	26.1	12:15pm	7.03	19.4°C
<u>Round 3</u>				
Turb	6.60	1:27pm	6.40	20.2°C
C01	20.0	1:42pm	7.13	19.2°C
C02	21.5	1:38pm	7.30	19.3°C
C03	57.7	1:32	7.06	19.6°C
C04	36.4	1:35	7.19	19.5°C
C05	22.2	1:28	6.90	19.5°C
C06	61.4	1:25pm	6.90	19.4°C

4/19/18

Pore Columns

Sample ID	Turb	Time	pl _t	Temp
CO2 COC	13.6	10:02	6.99	18.7
CO4	6.46	10:03	7.09	19.3
CO6	7.75	10:06	6.96	18.9
Influent	2.02	10:10	7.63	19.1
CO1	9.75	10:29	6.89	19.4
CO6	13.8	10:34	7.08	19.2
Influent	1.93	10:36	7.77	19.3
CO6	21.8	11:18	6.55	19.1°C
CO4	21.7	11:22	6.93	19.2°C
Influent	2.08	11:24	7.68	18.8°C

5/9/18

Column (Case) Influent Col	Turb	Time	pH	Temp
①	14.5	10:09	7.54	22.8 °C
Col	14.0	10:15	7.54	
Influent	16.8	10:10	6.59	22.0 °C

②

Col	22.0	10:35a	6.84	22.7 °C
Influent	16.0	10:34a	6.08	22 °C

Col	24.3	10:54a	6.59	22.3 °C
Influent	18.4	10:54a	6.28	22 °C

APPENDIX G: WATER QUALITY Data

Appendix G: Water Quality Data

Sample ID	Analyte Name	Unit Name	Result	MDL	RL	QA Code
CO2-EF-04102018-01	PCB 008	pg/L	76.2	18.3	48	NBC,VIL,VJ
CO2-EF-04102018-01	PCB 018/30	pg/L	69.5	28.6	48	NBC
CO2-EF-04102018-01	PCB 020/28	pg/L	90	42.2	48	JA,NBC
CO2-EF-04102018-01	PCB 021/33	pg/L	69.1	44.7	48	NBC
CO2-EF-04102018-01	PCB 031	pg/L	87.8	40.1	48	NBC
CO2-EF-04102018-01	PCB 044/47/65	pg/L	206	38.5	97	NBC,VIU
CO2-EF-04102018-01	PCB 049/69	pg/L	167	35.9	97	NBC,VIU
CO2-EF-04102018-01	PCB 052	pg/L	370	36.1	48	NBC,VIL,VIU
CO2-EF-04102018-01	PCB 056	pg/L		35.5	48	NBC
CO2-EF-04102018-01	PCB 060	pg/L		34.6	48	NBC
CO2-EF-04102018-01	PCB 066	pg/L	67.3	30.5	48	NBC,VIU
CO2-EF-04102018-01	PCB 070/61/74/76	pg/L	131	32.9	193	J,NBC,VIL,VIU,VJ
CO2-EF-04102018-01	PCB 083/99	pg/L	519	23.3	97	NBC,VIL,VJ,VIU
CO2-EF-04102018-01	PCB 086/87/97/109/119/125	pg/L	209	20.3	193	NBC,VIL,VIU
CO2-EF-04102018-01	PCB 090/101/113	pg/L	424	20.3	193	NBC,VIL,VIU
CO2-EF-04102018-01	PCB 093/95/100	pg/L	362	23.2	193	NBC,VIL,VIU
CO2-EF-04102018-01	PCB 105	pg/L	63.6	27.7	28	NBC,VIU
CO2-EF-04102018-01	PCB 110/115	pg/L	162	18.4	97	NBC
CO2-EF-04102018-01	PCB 118	pg/L	191	25.8	26	NBC,VIL
CO2-EF-04102018-01	PCB 128/166	pg/L	113	14.4	97	JA,NBC,VIL,VJ,VIU
CO2-EF-04102018-01	PCB 129/138/163	pg/L	1440	19.6	193	NBC,VIL,VJ,VIU
CO2-EF-04102018-01	PCB 132	pg/L	116	17.8	48	NBC,VIL,VIU
CO2-EF-04102018-01	PCB 135/151/154	pg/L	1050	10.6	97	VRIU,NBC,VIL,VJ
CO2-EF-04102018-01	PCB 141	pg/L	116	15.1	48	VRIU,NBC,VIL,VJ
CO2-EF-04102018-01	PCB 147/149	pg/L	670	15.1	97	NBC,VIL,VJ,VIU
CO2-EF-04102018-01	PCB 153/168	pg/L	5360	12.9	97	VIP,NBC,VIL,VJ,VIU
CO2-EF-04102018-01	PCB 156/157	pg/L	62	18	39	NBC,VIU
CO2-EF-04102018-01	PCB 158	pg/L	78.2	11.2	48	VRIU,NBC,VIL,VJ
CO2-EF-04102018-01	PCB 170	pg/L	525	29.1	48	NBC,VIL,VJ,VIU
CO2-EF-04102018-01	PCB 174	pg/L	163	23.8	48	NBC,VIL,VJ,VIU
CO2-EF-04102018-01	PCB 177	pg/L	262	25.6	48	NBC,VIL,VJ,VIU
CO2-EF-04102018-01	PCB 180/193	pg/L	1960	22.8	97	NBC,VIL,VJ,VIU
CO2-EF-04102018-01	PCB 183/185	pg/L	626	24.3	97	NBC,VIL,VJ,VIU
CO2-EF-04102018-01	PCB 187	pg/L	2270	14.1	48	NBC,VIL,VJ,VIU
CO2-EF-04102018-01	PCB 194	pg/L	734	28.4	48	NBC,VIL,VJ
CO2-EF-04102018-01	PCB 195	pg/L	172	25.9	48	NBC,VIL,VJ,VIU
CO2-EF-04102018-01	PCB 201	pg/L	79.1	14.9	48	VRIU,NBC,VIL,VJ
CO2-EF-04102018-01	PCB 203	pg/L	317	22.3	48	NBC,VIL,VJ,VIU
CO2-EF-04102018-01	Total DiCB	pg/L	76.2	18.3	19	NBC,VIL,VJ
CO2-EF-04102018-01	Total HeptaCB	pg/L	5170	14.1	19	NBC,VIL,VJ
CO2-EF-04102018-01	Total HexaCB	pg/L	9000	10.6	19	VIP,NBC,VIL,VJ
CO2-EF-04102018-01	Total MonoCB	pg/L		19.3	19	NBC
CO2-EF-04102018-01	Total NonaCB	pg/L		19.3	19	NBC
CO2-EF-04102018-01	Total OctaCB	pg/L	1300	14.9	19	NBC,VIL,VJ
CO2-EF-04102018-01	Total PCBs	pg/L	19400	10.6	193	VIP,NBC,VIL,VJ
CO2-EF-04102018-01	Total PentaCB	pg/L	1930	18.4	193	NBC,VIL

Appendix G: Water Quality Data

Sample ID	Analyte Name	Unit Name	Result	MDL	RL	QA Code
CO2-EF-04102018-01	Total TetraCB	pg/L	941	30.5	193	NBC,VIL
CO2-EF-04102018-01	Total TriCB	pg/L	316	28.6	48	NBC,VIL
CO3-EF-04102018-01	PCB 008	pg/L	76.3	2.87	49	NBC,VIL,VJ
CO3-EF-04102018-01	PCB 018/30	pg/L	62.3	6.37	49	NBC
CO3-EF-04102018-01	PCB 020/28	pg/L	114	7.02	49	NBC
CO3-EF-04102018-01	PCB 021/33	pg/L	56.1	7	49	NBC
CO3-EF-04102018-01	PCB 031	pg/L	91.5	6.49	49	NBC
CO3-EF-04102018-01	PCB 044/47/65	pg/L	78.7	6.23	98	J,NBC,VIU
CO3-EF-04102018-01	PCB 049/69	pg/L	41.8	5.86	98	J,NBC,VIU
CO3-EF-04102018-01	PCB 052	pg/L	107	6.17	49	NBC,VIL,VIU
CO3-EF-04102018-01	PCB 056	pg/L	23.8	7.96	49	J,JA,NBC
CO3-EF-04102018-01	PCB 060	pg/L	16.8	7.8	49	J,NBC
CO3-EF-04102018-01	PCB 066	pg/L	47.5	4.83	49	J,NBC,VIU
CO3-EF-04102018-01	PCB 070/61/74/76	pg/L	108	5.19	197	J,NBC,VIL,VIU,VJ
CO3-EF-04102018-01	PCB 083/99	pg/L	50.1	4.37	98	J,NBC,VIL,VJ,VIU
CO3-EF-04102018-01	PCB 086/87/97/109/119/125	pg/L	63.1	3.83	197	J,NBC,VIL,VIU
CO3-EF-04102018-01	PCB 090/101/113	pg/L	91.5	3.78	197	J,NBC,VIL,VIU
CO3-EF-04102018-01	PCB 093/95/100	pg/L	66.3	3	197	J,NBC,VIL,VIU
CO3-EF-04102018-01	PCB 105	pg/L	37.2	3.04	20	NBC,VIU
CO3-EF-04102018-01	PCB 110/115	pg/L	102	3.49	98	NBC
CO3-EF-04102018-01	PCB 118	pg/L	68.4	2.83	20	NBC,VIL
CO3-EF-04102018-01	PCB 128/166	pg/L	14.6	2.84	98	J,JA,NBC,VIL,VJ,VIU
CO3-EF-04102018-01	PCB 129/138/163	pg/L	133	3.7	197	J,NBC,VIL,VJ,VIU
CO3-EF-04102018-01	PCB 132	pg/L	29.6	3.38	49	J,NBC,VIL,VIU
CO3-EF-04102018-01	PCB 135/151/154	pg/L	28.9	2.59	98	VRIU,J,NBC,VIL,VJ
CO3-EF-04102018-01	PCB 141	pg/L	18.5	2.85	49	VRIU,J,NBC,VIL,VJ
CO3-EF-04102018-01	PCB 147/149	pg/L	60.1	2.8	98	J,NBC,VIL,VJ,VIU
CO3-EF-04102018-01	PCB 153/168	pg/L	92.8	2.44	98	VIP,J,NBC,VIL,VJ,VIU
CO3-EF-04102018-01	PCB 156/157	pg/L	11.1	8.04	39	J,JA,NBC,VIU
CO3-EF-04102018-01	PCB 158	pg/L	10.3	2.14	49	VRIU,J,NBC,VIL,VJ
CO3-EF-04102018-01	PCB 170	pg/L	28.8	5.59	49	J,JA,NBC,VIL,VJ,VIU
CO3-EF-04102018-01	PCB 174	pg/L	25.8	4.2	49	J,NBC,VIL,VJ,VIU
CO3-EF-04102018-01	PCB 177	pg/L	16.3	4.54	49	J,NBC,VIL,VJ,VIU
CO3-EF-04102018-01	PCB 180/193	pg/L	81	4.19	98	J,NBC,VIL,VJ,VIU
CO3-EF-04102018-01	PCB 183/185	pg/L	21.7	4.11	98	J,NBC,VIL,VJ,VIU
CO3-EF-04102018-01	PCB 187	pg/L	45.1	3.29	49	J,NBC,VIL,VJ,VIU
CO3-EF-04102018-01	PCB 194	pg/L	36	4.35	49	J,NBC,VIL,VJ
CO3-EF-04102018-01	PCB 195	pg/L	11.9	3.71	49	J,NBC,VIL,VJ,VIU
CO3-EF-04102018-01	PCB 201	pg/L	3.28	1.86	49	VRIU,J,JA,NBC,VIL,VJ
CO3-EF-04102018-01	PCB 203	pg/L	28.2	3.07	49	J,NBC,VIL,VJ,VIU
CO3-EF-04102018-01	Total DiCB	pg/L	76.3	2.87	20	NBC,VIL,VJ
CO3-EF-04102018-01	Total HeptaCB	pg/L	197	3.29	20	NBC,VIL,VJ
CO3-EF-04102018-01	Total HexaCB	pg/L	399	2.14	20	VIP,NBC,VIL,VJ
CO3-EF-04102018-01	Total MonoCB	pg/L		19.7	20	NBC
CO3-EF-04102018-01	Total NonaCB	pg/L		19.7	20	NBC
CO3-EF-04102018-01	Total OctaCB	pg/L	79.4	1.86	20	NBC,VIL,VJ

Appendix G: Water Quality Data

Sample ID	Analyte Name	Unit Name	Result	MDL	RL	QA Code
CO3-EF-04102018-01	Total PCBs	pg/L	2000	1.86	197	VIP,NBC,VIL,VJ
CO3-EF-04102018-01	Total PentaCB	pg/L	479	2.83	197	NBC,VIL
CO3-EF-04102018-01	Total TetraCB	pg/L	424	4.83	197	NBC,VIL
CO3-EF-04102018-01	Total TriCB	pg/L	324	6.37	49	NBC,VIL
CO4-EF-04102018-01	PCB 008	pg/L	104	4.41	48	NBC,VIL,VJ
CO4-EF-04102018-01	PCB 018/30	pg/L	105	8.46	48	NBC
CO4-EF-04102018-01	PCB 020/28	pg/L	162	10.8	48	NBC
CO4-EF-04102018-01	PCB 021/33	pg/L	98.2	10.8	48	NBC
CO4-EF-04102018-01	PCB 031	pg/L	130	9.97	48	NBC
CO4-EF-04102018-01	PCB 044/47/65	pg/L	127	6.12	96	NBC,VIU
CO4-EF-04102018-01	PCB 049/69	pg/L	75.6	5.75	96	J,NBC,VIU
CO4-EF-04102018-01	PCB 052	pg/L	161	6.05	48	NBC,VIL,VIU
CO4-EF-04102018-01	PCB 056	pg/L	44.7	8.87	48	J,JA,NBC
CO4-EF-04102018-01	PCB 060	pg/L	29.9	8.69	48	J,NBC
CO4-EF-04102018-01	PCB 066	pg/L	80.2	4.74	48	NBC,VIU
CO4-EF-04102018-01	PCB 070/61/74/76	pg/L	185	5.09	192	J,NBC,VIL,VIU,VJ
CO4-EF-04102018-01	PCB 083/99	pg/L	84.1	5.33	96	J,NBC,VIL,VJ,VIU
CO4-EF-04102018-01	PCB 086/87/97/109/119/125	pg/L	130	4.67	192	J,NBC,VIL,VIU
CO4-EF-04102018-01	PCB 090/101/113	pg/L	146	4.61	192	J,NBC,VIL,VIU
CO4-EF-04102018-01	PCB 093/95/100	pg/L	112	5.15	192	J,NBC,VIL,VIU
CO4-EF-04102018-01	PCB 105	pg/L	64.5	8.66	19	NBC,VIU
CO4-EF-04102018-01	PCB 110/115	pg/L	186	4.26	96	NBC
CO4-EF-04102018-01	PCB 118	pg/L	114	8.16	19	NBC,VIL
CO4-EF-04102018-01	PCB 128/166	pg/L	34.1	4.91	96	J,NBC,VIL,VJ,VIU
CO4-EF-04102018-01	PCB 129/138/163	pg/L	226	6.41	192	NBC,VIL,VJ,VIU
CO4-EF-04102018-01	PCB 132	pg/L	54.8	5.85	48	NBC,VIL,VIU
CO4-EF-04102018-01	PCB 135/151/154	pg/L	50.3	3.6	96	VRIU,J,NBC,VIL,VJ
CO4-EF-04102018-01	PCB 141	pg/L	31.8	4.94	48	VRIU,J,NBC,VIL,VJ
CO4-EF-04102018-01	PCB 147/149	pg/L	104	4.85	96	NBC,VIL,VJ,VIU
CO4-EF-04102018-01	PCB 153/168	pg/L	138	4.22	96	VIP,NBC,VIL,VJ,VIU
CO4-EF-04102018-01	PCB 156/157	pg/L	28.1	9.81	38	J,NBC,VIU
CO4-EF-04102018-01	PCB 158	pg/L	20.2	3.7	48	VRIU,J,NBC,VIL,VJ
CO4-EF-04102018-01	PCB 170	pg/L	45	8.2	48	J,NBC,VIL,VJ,VIU
CO4-EF-04102018-01	PCB 174	pg/L	45.6	6.17	48	J,NBC,VIL,VJ,VIU
CO4-EF-04102018-01	PCB 177	pg/L	24.3	6.65	48	J,NBC,VIL,VJ,VIU
CO4-EF-04102018-01	PCB 180/193	pg/L	118	6.15	96	NBC,VIL,VJ,VIU
CO4-EF-04102018-01	PCB 183/185	pg/L	38.6	6.03	96	J,NBC,VIL,VJ,VIU
CO4-EF-04102018-01	PCB 187	pg/L	65.4	3.19	48	NBC,VIL,VJ,VIU
CO4-EF-04102018-01	PCB 194	pg/L	49.5	6.04	48	NBC,VIL,VJ
CO4-EF-04102018-01	PCB 195	pg/L	16.3	5.15	48	J,JA,NBC,VIL,VJ,VIU
CO4-EF-04102018-01	PCB 201	pg/L	9.17	2.59	48	VRIU,J,NBC,VIL,VJ
CO4-EF-04102018-01	PCB 203	pg/L	34.6	4.26	48	J,NBC,VIL,VJ,VIU
CO4-EF-04102018-01	Total DiCB	pg/L	104	4.41	19	NBC,VIL,VJ
CO4-EF-04102018-01	Total HeptaCB	pg/L	298	3.19	19	NBC,VIL,VJ
CO4-EF-04102018-01	Total HexaCB	pg/L	687	3.6	19	VIP,NBC,VIL,VJ
CO4-EF-04102018-01	Total MonoCB	pg/L		19.2	19	NBC

Appendix G: Water Quality Data

Sample ID	Analyte Name	Unit Name	Result	MDL	RL	QA Code
CO4-EF-04102018-01	Total NonaCB	pg/L		19.2	19	NBC
CO4-EF-04102018-01	Total OctaCB	pg/L	110	2.59	19	NBC,VIL,VJ
CO4-EF-04102018-01	Total PCBs	pg/L	3270	2.59	192	VIP,NBC,VIL,VJ
CO4-EF-04102018-01	Total PentaCB	pg/L	837	4.26	192	NBC,VIL
CO4-EF-04102018-01	Total TetraCB	pg/L	704	4.74	192	NBC,VIL
CO4-EF-04102018-01	Total TriCB	pg/L	496	8.46	48	NBC,VIL
CO5-EF-04102018-01	PCB 008	pg/L	135	48	48	NBC,VIL,VJ
CO5-EF-04102018-01	PCB 018/30	pg/L	117	97.6	98	JA,NBC
CO5-EF-04102018-01	PCB 020/28	pg/L	206	116	116	NBC
CO5-EF-04102018-01	PCB 021/33	pg/L		116	116	NBC
CO5-EF-04102018-01	PCB 031	pg/L	149	107	107	JA,NBC
CO5-EF-04102018-01	PCB 044/47/65	pg/L	137	80.3	96	NBC,VIU
CO5-EF-04102018-01	PCB 049/69	pg/L	129	75.4	96	NBC,VIU
CO5-EF-04102018-01	PCB 052	pg/L	306	79.4	79	NBC,VIL,VIU
CO5-EF-04102018-01	PCB 056	pg/L		89.9	90	NBC
CO5-EF-04102018-01	PCB 060	pg/L		88	88	NBC
CO5-EF-04102018-01	PCB 066	pg/L		62.2	62	NBC,VIU
CO5-EF-04102018-01	PCB 070/61/74/76	pg/L	139	66.8	191	J,NBC,VIL,VIU,VJ
CO5-EF-04102018-01	PCB 083/99	pg/L		70.6	96	NBC,VIL,VJ,VIU
CO5-EF-04102018-01	PCB 086/87/97/109/119/125	pg/L		61.8	191	NBC,VIL,VIU
CO5-EF-04102018-01	PCB 090/101/113	pg/L		61	191	NBC,VIL,VIU
CO5-EF-04102018-01	PCB 093/95/100	pg/L		87.1	191	NBC,VIL,VIU
CO5-EF-04102018-01	PCB 105	pg/L		57.5	58	NBC,VIU
CO5-EF-04102018-01	PCB 110/115	pg/L	121	56.4	96	NBC
CO5-EF-04102018-01	PCB 118	pg/L	78.3	53.8	54	NBC,VIL
CO5-EF-04102018-01	PCB 128/166	pg/L		44	96	NBC,VIL,VJ,VIU
CO5-EF-04102018-01	PCB 129/138/163	pg/L	182	57.4	191	J,NBC,VIL,VJ,VIU
CO5-EF-04102018-01	PCB 132	pg/L		52.4	52	NBC,VIL,VIU
CO5-EF-04102018-01	PCB 135/151/154	pg/L		48.9	96	VRIU,NBC,VIL,VJ
CO5-EF-04102018-01	PCB 141	pg/L		44.2	48	VRIU,NBC,VIL,VJ
CO5-EF-04102018-01	PCB 147/149	pg/L	76.7	43.4	96	J,NBC,VIL,VJ,VIU
CO5-EF-04102018-01	PCB 153/168	pg/L	219	37.7	96	VIP,NBC,VIL,VJ,VIU
CO5-EF-04102018-01	PCB 156/157	pg/L		78.7	79	NBC,VIU
CO5-EF-04102018-01	PCB 158	pg/L		33.1	48	VRIU,NBC,VIL,VJ
CO5-EF-04102018-01	PCB 170	pg/L		129	129	NBC,VIL,VJ,VIU
CO5-EF-04102018-01	PCB 174	pg/L		96.7	97	NBC,VIL,VJ,VIU
CO5-EF-04102018-01	PCB 177	pg/L		105	105	NBC,VIL,VJ,VIU
CO5-EF-04102018-01	PCB 180/193	pg/L	103	96.4	96	NBC,VIL,VJ,VIU
CO5-EF-04102018-01	PCB 183/185	pg/L		94.5	96	NBC,VIL,VJ,VIU
CO5-EF-04102018-01	PCB 187	pg/L	61.8	46	48	NBC,VIL,VJ,VIU
CO5-EF-04102018-01	PCB 194	pg/L		106	106	NBC,VIL,VJ
CO5-EF-04102018-01	PCB 195	pg/L		89.9	90	NBC,VIL,VJ,VIU
CO5-EF-04102018-01	PCB 201	pg/L		45.1	48	VRIU,NBC,VIL,VJ
CO5-EF-04102018-01	PCB 203	pg/L		74.4	74	NBC,VIL,VJ,VIU
CO5-EF-04102018-01	Total DiCB	pg/L	135	48	48	NBC,VIL,VJ
CO5-EF-04102018-01	Total HeptaCB	pg/L	165	46	46	NBC,VIL,VJ

Appendix G: Water Quality Data

Sample ID	Analyte Name	Unit Name	Result	MDL	RL	QA Code
CO5-EF-04102018-01	Total HexaCB	pg/L	478	33.1	33	VIP,NBC,VIL,VJ
CO5-EF-04102018-01	Total MonoCB	pg/L		19.1	19	NBC
CO5-EF-04102018-01	Total NonaCB	pg/L		19.1	19	NBC
CO5-EF-04102018-01	Total OctaCB	pg/L		45.1	45	NBC,VIL,VJ
CO5-EF-04102018-01	Total PCBs	pg/L	2160	33.1	191	VIP,NBC,VIL,VJ
CO5-EF-04102018-01	Total PentaCB	pg/L	199	53.8	191	NBC,VIL
CO5-EF-04102018-01	Total TetraCB	pg/L	711	62.2	191	NBC,VIL
CO5-EF-04102018-01	Total TriCB	pg/L	473	97.6	98	NBC,VIL
CO6-EF-04102018-01	PCB 008	pg/L	99.7	1.26	48	NBC,VIL,VJ
CO6-EF-04102018-01	PCB 018/30	pg/L	125	5.01	48	NBC
CO6-EF-04102018-01	PCB 020/28	pg/L	164	7.93	48	NBC
CO6-EF-04102018-01	PCB 021/33	pg/L	86.3	7.9	48	NBC
CO6-EF-04102018-01	PCB 031	pg/L	130	7.33	48	NBC
CO6-EF-04102018-01	PCB 044/47/65	pg/L	133	3.68	96	NBC,VIU
CO6-EF-04102018-01	PCB 049/69	pg/L	70.8	3.46	96	J,NBC,VIU
CO6-EF-04102018-01	PCB 052	pg/L	169	3.64	48	NBC,VIL,VIU
CO6-EF-04102018-01	PCB 056	pg/L	40.8	7.08	48	J,NBC
CO6-EF-04102018-01	PCB 060	pg/L	24.5	6.93	48	J,NBC
CO6-EF-04102018-01	PCB 066	pg/L	74.2	2.85	48	NBC,VIU
CO6-EF-04102018-01	PCB 070/61/74/76	pg/L	167	3.07	192	J,NBC,VIL,VIU,VJ
CO6-EF-04102018-01	PCB 083/99	pg/L	67.3	2.9	96	J,NBC,VIL,VJ,VIU
CO6-EF-04102018-01	PCB 086/87/97/109/119/125	pg/L	102	2.54	192	J,NBC,VIL,VIU
CO6-EF-04102018-01	PCB 090/101/113	pg/L	135	2.51	192	J,NBC,VIL,VIU
CO6-EF-04102018-01	PCB 093/95/100	pg/L	113	2.35	192	J,NBC,VIL,VIU
CO6-EF-04102018-01	PCB 105	pg/L	49.3	4.61	19	NBC,VIU
CO6-EF-04102018-01	PCB 110/115	pg/L	159	2.32	96	NBC
CO6-EF-04102018-01	PCB 118	pg/L	106	4.17	19	NBC,VIL
CO6-EF-04102018-01	PCB 128/166	pg/L	23.3	2.94	96	J,NBC,VIL,VJ,VIU
CO6-EF-04102018-01	PCB 129/138/163	pg/L	187	3.84	192	J,NBC,VIL,VJ,VIU
CO6-EF-04102018-01	PCB 132	pg/L	45.1	3.5	48	J,NBC,VIL,VIU
CO6-EF-04102018-01	PCB 135/151/154	pg/L	42	2.57	96	VRIU,J,NBC,VIL,VJ
CO6-EF-04102018-01	PCB 141	pg/L	24.2	2.96	48	VRIU,J,NBC,VIL,VJ
CO6-EF-04102018-01	PCB 147/149	pg/L	96.5	2.91	96	NBC,VIL,VJ,VIU
CO6-EF-04102018-01	PCB 153/168	pg/L	115	2.52	96	VIP,NBC,VIL,VJ,VIU
CO6-EF-04102018-01	PCB 156/157	pg/L	16.9	5.34	39	J,NBC,VIU
CO6-EF-04102018-01	PCB 158	pg/L	15.3	2.22	48	VRIU,J,NBC,VIL,VJ
CO6-EF-04102018-01	PCB 170	pg/L	35.9	5.28	48	J,NBC,VIL,VJ,VIU
CO6-EF-04102018-01	PCB 174	pg/L	33.8	3.97	48	J,NBC,VIL,VJ,VIU
CO6-EF-04102018-01	PCB 177	pg/L	21.2	4.29	48	J,NBC,VIL,VJ,VIU
CO6-EF-04102018-01	PCB 180/193	pg/L	84.8	3.96	96	J,NBC,VIL,VJ,VIU
CO6-EF-04102018-01	PCB 183/185	pg/L	27.2	3.88	96	J,NBC,VIL,VJ,VIU
CO6-EF-04102018-01	PCB 187	pg/L	51.6	2.29	48	NBC,VIL,VJ,VIU
CO6-EF-04102018-01	PCB 194	pg/L	35.8	4.57	48	J,NBC,VIL,VJ
CO6-EF-04102018-01	PCB 195	pg/L	14.6	3.9	48	J,NBC,VIL,VJ,VIU
CO6-EF-04102018-01	PCB 201	pg/L	5.85	1.96	48	VRIU,J,NBC,VIL,VJ
CO6-EF-04102018-01	PCB 203	pg/L	27.3	3.23	48	J,JA,NBC,VIL,VJ,VIU

Appendix G: Water Quality Data

Sample ID	Analyte Name	Unit Name	Result	MDL	RL	QA Code
CO6-EF-04102018-01	Total DiCB	pg/L	99.7	1.26	19	NBC,VIL,VJ
CO6-EF-04102018-01	Total HeptaCB	pg/L	227	2.29	19	NBC,VIL,VJ
CO6-EF-04102018-01	Total HexaCB	pg/L	565	2.22	19	VIP,NBC,VIL,VJ
CO6-EF-04102018-01	Total MonoCB	pg/L		19.2	19	NBC
CO6-EF-04102018-01	Total NonaCB	pg/L		19.2	19	NBC
CO6-EF-04102018-01	Total OctaCB	pg/L	83.6	1.96	19	NBC,VIL,VJ
CO6-EF-04102018-01	Total PCBs	pg/L	2920	1.26	192	VIP,NBC,VIL,VJ
CO6-EF-04102018-01	Total PentaCB	pg/L	732	2.32	192	NBC,VIL
CO6-EF-04102018-01	Total TetraCB	pg/L	680	2.85	192	NBC,VIL
CO6-EF-04102018-01	Total TriCB	pg/L	506	5.01	48	NBC,VIL
TW2-IN-04102018-01	PCB 008	pg/L	130	10.7	49	NBC,VIL,VJ
TW2-IN-04102018-01	PCB 018/30	pg/L	218	37.4	49	NBC
TW2-IN-04102018-01	PCB 020/28	pg/L	489	44.4	49	NBC
TW2-IN-04102018-01	PCB 021/33	pg/L	337	47	49	NBC
TW2-IN-04102018-01	PCB 031	pg/L	397	42.2	49	NBC
TW2-IN-04102018-01	PCB 044/47/65	pg/L	545	52.3	98	NBC,VIU
TW2-IN-04102018-01	PCB 049/69	pg/L	275	48.7	98	NBC,VIU
TW2-IN-04102018-01	PCB 052	pg/L	508	49	49	NBC,VIL,VIU
TW2-IN-04102018-01	PCB 056	pg/L	223	32.4	49	NBC
TW2-IN-04102018-01	PCB 060	pg/L	128	31.6	49	NBC
TW2-IN-04102018-01	PCB 066	pg/L	322	41.4	49	NBC,VIU
TW2-IN-04102018-01	PCB 070/61/74/76	pg/L	717	44.7	195	NBC,VIL,VIU,VJ
TW2-IN-04102018-01	PCB 083/99	pg/L	367	27.3	98	NBC,VIL,VJ,VIU
TW2-IN-04102018-01	PCB 086/87/97/109/119/125	pg/L	443	23.8	195	NBC,VIL,VIU
TW2-IN-04102018-01	PCB 090/101/113	pg/L	527	23.8	195	JA,NBC,VIL,VIU
TW2-IN-04102018-01	PCB 093/95/100	pg/L	470	31.8	195	NBC,VIL,VIU
TW2-IN-04102018-01	PCB 105	pg/L	325	21.3	21	NBC,VIU
TW2-IN-04102018-01	PCB 110/115	pg/L	822	21.5	98	NBC
TW2-IN-04102018-01	PCB 118	pg/L	554	19.5	20	NBC,VIL
TW2-IN-04102018-01	PCB 128/166	pg/L	186	23.9	98	NBC,VIL,VJ,VIU
TW2-IN-04102018-01	PCB 129/138/163	pg/L	1690	32.5	195	NBC,VIL,VJ,VIU
TW2-IN-04102018-01	PCB 132	pg/L	368	29.6	49	NBC,VIL,VIU
TW2-IN-04102018-01	PCB 135/151/154	pg/L	584	16.6	98	VRIU,NBC,VIL,VJ
TW2-IN-04102018-01	PCB 141	pg/L	213	25	49	VRIU,NBC,VIL,VJ
TW2-IN-04102018-01	PCB 147/149	pg/L	963	25.1	98	NBC,VIL,VJ,VIU
TW2-IN-04102018-01	PCB 153/168	pg/L	1710	21.3	98	VIP,NBC,VIL,VJ,VIU
TW2-IN-04102018-01	PCB 156/157	pg/L	145	44.6	45	NBC,VIU
TW2-IN-04102018-01	PCB 158	pg/L	110	18.6	49	VRIU,NBC,VIL,VJ
TW2-IN-04102018-01	PCB 170	pg/L	540	36.4	49	NBC,VIL,VJ,VIU
TW2-IN-04102018-01	PCB 174	pg/L	608	29.8	49	NBC,VIL,VJ,VIU
TW2-IN-04102018-01	PCB 177	pg/L	361	32	49	NBC,VIL,VJ,VIU
TW2-IN-04102018-01	PCB 180/193	pg/L	1550	28.6	98	NBC,VIL,VJ,VIU
TW2-IN-04102018-01	PCB 183/185	pg/L	529	30.4	98	NBC,VIL,VJ,VIU
TW2-IN-04102018-01	PCB 187	pg/L	1100	17.1	49	NBC,VIL,VJ,VIU
TW2-IN-04102018-01	PCB 194	pg/L	560	35.7	49	NBC,VIL,VJ
TW2-IN-04102018-01	PCB 195	pg/L	192	32.6	49	JA,NBC,VIL,VJ,VIU

Appendix G: Water Quality Data

Sample ID	Analyte Name	Unit Name	Result	MDL	RL	QA Code
TW2-IN-04102018-01	PCB 201	pg/L	69.4	18.8	49	VRIU,NBC,VIL,VJ
TW2-IN-04102018-01	PCB 203	pg/L	365	28	49	NBC,VIL,VJ,VIU
TW2-IN-04102018-01	Total DiCB	pg/L	130	10.7	20	NBC,VIL,VJ
TW2-IN-04102018-01	Total HeptaCB	pg/L	4160	17.1	20	NBC,VIL,VJ
TW2-IN-04102018-01	Total HexaCB	pg/L	5970	16.6	20	VIP,NBC,VIL,VJ
TW2-IN-04102018-01	Total MonoCB	pg/L		19.5	20	NBC
TW2-IN-04102018-01	Total NonaCB	pg/L		19.5	20	NBC
TW2-IN-04102018-01	Total OctaCB	pg/L	1190	18.8	20	NBC,VIL,VJ
TW2-IN-04102018-01	Total PCBs	pg/L	19600	10.7	195	VIP,NBC,VIL,VJ
TW2-IN-04102018-01	Total PentaCB	pg/L	3510	19.5	195	NBC,VIL
TW2-IN-04102018-01	Total TetraCB	pg/L	2720	31.6	195	NBC,VIL
TW2-IN-04102018-01	Total TriCB	pg/L	1440	37.4	49	NBC,VIL
CO1-EF-04132018-01	PCB 008	pg/L	74.8	2.31	48	NBC,VIL,VJ
CO1-EF-04132018-01	PCB 018/30	pg/L	60.3	5.02	48	NBC
CO1-EF-04132018-01	PCB 020/28	pg/L	84.8	12	48	NBC
CO1-EF-04132018-01	PCB 021/33	pg/L	50.6	12	48	NBC
CO1-EF-04132018-01	PCB 031	pg/L	65.8	11.1	48	NBC
CO1-EF-04132018-01	PCB 044/47/65	pg/L	105	5.15	96	NBC,VIU
CO1-EF-04132018-01	PCB 049/69	pg/L	74.9	4.84	96	J,NBC,VIU
CO1-EF-04132018-01	PCB 052	pg/L	160	5.09	48	NBC,VIL,VIU
CO1-EF-04132018-01	PCB 056	pg/L	38.2	27.4	48	J,NBC
CO1-EF-04132018-01	PCB 060	pg/L		26.8	48	NBC
CO1-EF-04132018-01	PCB 066	pg/L	52.8	3.99	48	NBC,VIU
CO1-EF-04132018-01	PCB 070/61/74/76	pg/L	111	4.28	192	J,NBC,VIL,VIU,VJ
CO1-EF-04132018-01	PCB 083/99	pg/L	531	4.87	96	NBC,VIL,VJ,VIU
CO1-EF-04132018-01	PCB 086/87/97/109/119/125	pg/L	184	4.26	192	J,NBC,VIL,VIU
CO1-EF-04132018-01	PCB 090/101/113	pg/L	405	4.21	192	NBC,VIL,VIU
CO1-EF-04132018-01	PCB 093/95/100	pg/L	211	3.39	192	NBC,VIL,VIU
CO1-EF-04132018-01	PCB 105	pg/L	82.7	12	19	NBC,VIU
CO1-EF-04132018-01	PCB 110/115	pg/L	147	3.89	96	NBC
CO1-EF-04132018-01	PCB 118	pg/L	277	10.9	19	NBC,VIL
CO1-EF-04132018-01	PCB 128/166	pg/L	224	5.47	96	NBC,VIL,VJ,VIU
CO1-EF-04132018-01	PCB 129/138/163	pg/L	2450	7.14	192	NBC,VIL,VJ,VIU
CO1-EF-04132018-01	PCB 132	pg/L	142	6.51	48	NBC,VIL,VIU
CO1-EF-04132018-01	PCB 135/151/154	pg/L	1360	3.39	96	VRIU,NBC,VIL,VJ
CO1-EF-04132018-01	PCB 141	pg/L	176	5.5	48	VRIU,NBC,VIL,VJ
CO1-EF-04132018-01	PCB 147/149	pg/L	980	5.4	96	NBC,VIL,VJ,VIU
CO1-EF-04132018-01	PCB 153/168	pg/L	9440	4.69	96	VIP,NBC,VIL,VJ,VIU
CO1-EF-04132018-01	PCB 156/157	pg/L	115	14.9	38	NBC,VIU
CO1-EF-04132018-01	PCB 158	pg/L	125	4.12	48	VRIU,NBC,VIL,VJ
CO1-EF-04132018-01	PCB 170	pg/L	1160	8.02	48	NBC,VIL,VJ,VIU
CO1-EF-04132018-01	PCB 174	pg/L	308	6.03	48	NBC,VIL,VJ,VIU
CO1-EF-04132018-01	PCB 177	pg/L	520	6.5	48	NBC,VIL,VJ,VIU
CO1-EF-04132018-01	PCB 180/193	pg/L	4090	6.01	96	NBC,VIL,VJ,VIU
CO1-EF-04132018-01	PCB 183/185	pg/L	1250	5.89	96	NBC,VIL,VJ,VIU
CO1-EF-04132018-01	PCB 187	pg/L	4380	3.23	48	NBC,VIL,VJ,VIU

Appendix G: Water Quality Data

Sample ID	Analyte Name	Unit Name	Result	MDL	RL	QA Code
CO1-EF-04132018-01	PCB 194	pg/L	1480	6.25	48	NBC,VIL,VJ
CO1-EF-04132018-01	PCB 195	pg/L	348	5.33	48	NBC,VIL,VJ,VIU
CO1-EF-04132018-01	PCB 201	pg/L	152	2.68	48	VRIU,NBC,VIL,VJ
CO1-EF-04132018-01	PCB 203	pg/L	622	4.41	48	NBC,VIL,VJ,VIU
CO1-EF-04132018-01	Total DiCB	pg/L	74.8	2.31	19	NBC,VIL,VJ
CO1-EF-04132018-01	Total HeptaCB	pg/L	10500	3.23	19	NBC,VIL,VJ
CO1-EF-04132018-01	Total HexaCB	pg/L	15000	3.39	19	VIP,NBC,VIL,VJ
CO1-EF-04132018-01	Total MonoCB	pg/L		19.2	19	NBC
CO1-EF-04132018-01	Total NonaCB	pg/L		19.2	19	NBC
CO1-EF-04132018-01	Total OctaCB	pg/L	2610	2.68	19	NBC,VIL,VJ
CO1-EF-04132018-01	Total PCBs	pg/L	32000	2.31	192	VIP,NBC,VIL,VJ
CO1-EF-04132018-01	Total PentaCB	pg/L	1840	3.39	192	NBC,VIL
CO1-EF-04132018-01	Total TetraCB	pg/L	542	3.99	192	NBC,VIL
CO1-EF-04132018-01	Total TriCB	pg/L	261	5.02	48	NBC,VIL
CO2-EF-04132018-01	PCB 008	pg/L	19.4	1.28	48	J,NBC,VIL,VJ
CO2-EF-04132018-01	PCB 018/30	pg/L	21.6	3.12	48	J,NBC
CO2-EF-04132018-01	PCB 020/28	pg/L	33.3	3.86	48	J,NBC
CO2-EF-04132018-01	PCB 021/33	pg/L	21.6	3.94	48	J,NBC
CO2-EF-04132018-01	PCB 031	pg/L	28.7	3.6	48	J,NBC
CO2-EF-04132018-01	PCB 044/47/65	pg/L	46.5	2.79	96	J,NBC,VIU
CO2-EF-04132018-01	PCB 049/69	pg/L	24.9	2.65	96	J,NBC,VIU
CO2-EF-04132018-01	PCB 052	pg/L	73.3	2.72	48	NBC,VIL,VIU
CO2-EF-04132018-01	PCB 056	pg/L	8.37	4.63	48	J,NBC
CO2-EF-04132018-01	PCB 060	pg/L	5.01	4.55	48	J,NBC
CO2-EF-04132018-01	PCB 066	pg/L	15	2.26	48	J,NBC,VIU
CO2-EF-04132018-01	PCB 070/61/74/76	pg/L	37.5	2.42	191	J,NBC,VIL,VIU,VJ
CO2-EF-04132018-01	PCB 083/99	pg/L	19.8	2.74	96	J,NBC,VIL,VJ,VIU
CO2-EF-04132018-01	PCB 086/87/97/109/119/125	pg/L	28.1	2.39	191	J,NBC,VIL,VIU
CO2-EF-04132018-01	PCB 090/101/113	pg/L	39.5	2.36	191	J,NBC,VIL,VIU
CO2-EF-04132018-01	PCB 093/95/100	pg/L	39.8	1.83	191	J,NBC,VIL,VIU
CO2-EF-04132018-01	PCB 105	pg/L	11.3	3.41	19	J,JA,NBC,VIU
CO2-EF-04132018-01	PCB 110/115	pg/L	39.6	2.17	96	J,NBC
CO2-EF-04132018-01	PCB 118	pg/L	23.1	3.13	19	NBC,VIL
CO2-EF-04132018-01	PCB 128/166	pg/L	8.08	2.45	96	J,NBC,VIL,VJ,VIU
CO2-EF-04132018-01	PCB 129/138/163	pg/L	69.7	3.24	191	J,NBC,VIL,VJ,VIU
CO2-EF-04132018-01	PCB 132	pg/L	14.9	2.83	48	J,NBC,VIL,VIU
CO2-EF-04132018-01	PCB 135/151/154	pg/L	19.9	1.26	96	VRIU,J,NBC,VIL,VJ
CO2-EF-04132018-01	PCB 141	pg/L	8.4	2.45	48	VRIU,J,NBC,VIL,VJ
CO2-EF-04132018-01	PCB 147/149	pg/L	31.7	2.33	96	J,NBC,VIL,VJ,VIU
CO2-EF-04132018-01	PCB 153/168	pg/L	60.6	2.07	96	VIP,J,NBC,VIL,VJ,VIU
CO2-EF-04132018-01	PCB 156/157	pg/L	9.15	5.15	38	J,JA,NBC,VIU
CO2-EF-04132018-01	PCB 158	pg/L	5.91	1.83	48	VRIU,J,NBC,VIL,VJ
CO2-EF-04132018-01	PCB 170	pg/L	18.2	4.4	48	J,JA,NBC,VIL,VJ,VIU
CO2-EF-04132018-01	PCB 174	pg/L	12.8	3.11	48	J,NBC,VIL,VJ,VIU
CO2-EF-04132018-01	PCB 177	pg/L	9.24	3.44	48	J,NBC,VIL,VJ,VIU
CO2-EF-04132018-01	PCB 180/193	pg/L	42.4	3.33	96	J,NBC,VIL,VJ,VIU

Appendix G: Water Quality Data

Sample ID	Analyte Name	Unit Name	Result	MDL	RL	QA Code
CO2-EF-04132018-01	PCB 183/185	pg/L	16.2	3.24	96	J,NBC,VIL,VJ,VIU
CO2-EF-04132018-01	PCB 187	pg/L	26.9	1.6	48	J,NBC,VIL,VJ,VIU
CO2-EF-04132018-01	PCB 194	pg/L	17.5	2.9	48	J,NBC,VIL,VJ
CO2-EF-04132018-01	PCB 195	pg/L	6.09	2.5	48	J,NBC,VIL,VJ,VIU
CO2-EF-04132018-01	PCB 201	pg/L	2.47	1.28	48	VRIU,J,JA,NBC,VIL,VJ
CO2-EF-04132018-01	PCB 203	pg/L	9.22	2.1	48	J,JA,NBC,VIL,VJ,VIU
CO2-EF-04132018-01	Total DiCB	pg/L	19.4	1.28	19	NBC,VIL,VJ
CO2-EF-04132018-01	Total HeptaCB	pg/L	109	1.6	19	NBC,VIL,VJ
CO2-EF-04132018-01	Total HexaCB	pg/L	228	1.26	19	VIP,NBC,VIL,VJ
CO2-EF-04132018-01	Total MonoCB	pg/L		19.1	19	NBC
CO2-EF-04132018-01	Total NonaCB	pg/L		19.1	19	NBC
CO2-EF-04132018-01	Total OctaCB	pg/L	35.3	1.28	19	NBC,VIL,VJ
CO2-EF-04132018-01	Total PCBs	pg/L	926	1.26	191	VIP,NBC,VIL,VJ
CO2-EF-04132018-01	Total PentaCB	pg/L	201	1.83	191	NBC,VIL
CO2-EF-04132018-01	Total TetraCB	pg/L	211	2.26	191	NBC,VIL
CO2-EF-04132018-01	Total TriCB	pg/L	105	3.12	48	NBC,VIL
CO3-EF-04132018-01	PCB 008	pg/L	40.9	0.85	48	J,NBC,VIL,VJ
CO3-EF-04132018-01	PCB 018/30	pg/L	45.7	3.09	48	J,NBC
CO3-EF-04132018-01	PCB 020/28	pg/L	52.3	5.23	48	NBC
CO3-EF-04132018-01	PCB 021/33	pg/L	30.9	5.34	48	J,NBC
CO3-EF-04132018-01	PCB 031	pg/L	46.2	4.88	48	J,NBC
CO3-EF-04132018-01	PCB 044/47/65	pg/L	68	2.8	96	J,NBC,VIU
CO3-EF-04132018-01	PCB 049/69	pg/L	39.8	2.66	96	J,NBC,VIU
CO3-EF-04132018-01	PCB 052	pg/L	108	2.73	48	NBC,VIL,VIU
CO3-EF-04132018-01	PCB 056	pg/L	12.4	4.81	48	J,NBC
CO3-EF-04132018-01	PCB 060	pg/L	8.03	4.72	48	J,NBC
CO3-EF-04132018-01	PCB 066	pg/L	24.9	2.27	48	J,NBC,VIU
CO3-EF-04132018-01	PCB 070/61/74/76	pg/L	56.7	2.43	191	J,NBC,VIL,VIU,VJ
CO3-EF-04132018-01	PCB 083/99	pg/L	62.8	1.89	96	J,NBC,VIL,VJ,VIU
CO3-EF-04132018-01	PCB 086/87/97/109/119/125	pg/L	41.9	1.65	191	J,NBC,VIL,VIU
CO3-EF-04132018-01	PCB 090/101/113	pg/L	70.9	1.63	191	J,NBC,VIL,VIU
CO3-EF-04132018-01	PCB 093/95/100	pg/L	65.8	2.54	191	J,NBC,VIL,VIU
CO3-EF-04132018-01	PCB 105	pg/L	17.5	3.94	19	J,JA,NBC,VIU
CO3-EF-04132018-01	PCB 110/115	pg/L	53.2	1.5	96	J,NBC
CO3-EF-04132018-01	PCB 118	pg/L	46.1	3.55	19	NBC,VIL
CO3-EF-04132018-01	PCB 128/166	pg/L	15.2	3.6	96	J,NBC,VIL,VJ,VIU
CO3-EF-04132018-01	PCB 129/138/163	pg/L	169	4.77	191	J,NBC,VIL,VJ,VIU
CO3-EF-04132018-01	PCB 132	pg/L	20.8	4.16	48	J,NBC,VIL,VIU
CO3-EF-04132018-01	PCB 135/151/154	pg/L	69.5	1.6	96	VRIU,J,NBC,VIL,VJ
CO3-EF-04132018-01	PCB 141	pg/L	17.7	3.6	48	VRIU,J,NBC,VIL,VJ
CO3-EF-04132018-01	PCB 147/149	pg/L	59.4	3.43	96	J,NBC,VIL,VJ,VIU
CO3-EF-04132018-01	PCB 153/168	pg/L	427	3.05	96	VIP,NBC,VIL,VJ,VIU
CO3-EF-04132018-01	PCB 156/157	pg/L	11	5.5	38	J,JA,NBC,VIU
CO3-EF-04132018-01	PCB 158	pg/L	9.79	2.69	48	VRIU,J,NBC,VIL,VJ
CO3-EF-04132018-01	PCB 170	pg/L	51.1	3.92	48	JA,NBC,VIL,VJ,VIU
CO3-EF-04132018-01	PCB 174	pg/L	24.7	2.77	48	J,NBC,VIL,VJ,VIU

Appendix G: Water Quality Data

Sample ID	Analyte Name	Unit Name	Result	MDL	RL	QA Code
CO3-EF-04132018-01	PCB 177	pg/L	24.4	3.07	48	J,NBC,VIL,VJ,VIU
CO3-EF-04132018-01	PCB 180/193	pg/L	166	2.96	96	NBC,VIL,VJ,VIU
CO3-EF-04132018-01	PCB 183/185	pg/L	53.5	2.88	96	J,NBC,VIL,VJ,VIU
CO3-EF-04132018-01	PCB 187	pg/L	166	2.02	48	NBC,VIL,VJ,VIU
CO3-EF-04132018-01	PCB 194	pg/L	48.3	5	48	NBC,VIL,VJ
CO3-EF-04132018-01	PCB 195	pg/L	15.8	4.31	48	J,NBC,VIL,VJ,VIU
CO3-EF-04132018-01	PCB 201	pg/L	6.08	2.21	48	VRIU,J,NBC,VIL,VJ
CO3-EF-04132018-01	PCB 203	pg/L	22.3	3.63	48	J,JA,NBC,VIL,VJ,VIU
CO3-EF-04132018-01	Total DiCB	pg/L	40.9	0.85	19	NBC,VIL,VJ
CO3-EF-04132018-01	Total HeptaCB	pg/L	432	2.02	19	NBC,VIL,VJ
CO3-EF-04132018-01	Total HexaCB	pg/L	799	1.6	19	VIP,NBC,VIL,VJ
CO3-EF-04132018-01	Total MonoCB	pg/L		19.1	19	NBC
CO3-EF-04132018-01	Total NonaCB	pg/L		19.1	19	NBC
CO3-EF-04132018-01	Total OctaCB	pg/L	92.4	2.21	19	NBC,VIL,VJ
CO3-EF-04132018-01	Total PCBs	pg/L	2270	0.85	191	VIP,NBC,VIL,VJ
CO3-EF-04132018-01	Total PentaCB	pg/L	358	1.5	191	NBC,VIL
CO3-EF-04132018-01	Total TetraCB	pg/L	318	2.27	191	NBC,VIL
CO3-EF-04132018-01	Total TriCB	pg/L	175	3.09	48	NBC,VIL
CO4-EF-04132018-01	PCB 008	pg/L	47.3	1.41	50	J,NBC,VIL,VJ
CO4-EF-04132018-01	PCB 018/30	pg/L	65.4	3.95	50	NBC
CO4-EF-04132018-01	PCB 020/28	pg/L	75	4.57	50	NBC
CO4-EF-04132018-01	PCB 021/33	pg/L	42.4	4.67	50	J,NBC
CO4-EF-04132018-01	PCB 031	pg/L	59.7	4.27	50	NBC
CO4-EF-04132018-01	PCB 044/47/65	pg/L	82.9	2.72	101	J,NBC,VIU
CO4-EF-04132018-01	PCB 049/69	pg/L	40.7	2.57	101	J,NBC,VIU
CO4-EF-04132018-01	PCB 052	pg/L	108	2.64	50	NBC,VIL,VIU
CO4-EF-04132018-01	PCB 056	pg/L	18.8	7.34	50	J,NBC
CO4-EF-04132018-01	PCB 060	pg/L	11.4	7.21	50	J,NBC
CO4-EF-04132018-01	PCB 066	pg/L	38	2.2	50	J,NBC,VIU
CO4-EF-04132018-01	PCB 070/61/74/76	pg/L	79.6	2.36	201	J,NBC,VIL,VIU,VJ
CO4-EF-04132018-01	PCB 083/99	pg/L	36.2	4.47	101	J,NBC,VIL,VJ,VIU
CO4-EF-04132018-01	PCB 086/87/97/109/119/125	pg/L	58.2	3.91	201	J,NBC,VIL,VIU
CO4-EF-04132018-01	PCB 090/101/113	pg/L	78.9	3.86	201	J,JA,NBC,VIL,VIU
CO4-EF-04132018-01	PCB 093/95/100	pg/L	76.2	2.89	201	J,NBC,VIL,VIU
CO4-EF-04132018-01	PCB 105	pg/L	25.4	8.33	20	JA,NBC,VIU
CO4-EF-04132018-01	PCB 110/115	pg/L	88.3	3.55	101	J,NBC
CO4-EF-04132018-01	PCB 118	pg/L	52.6	7.21	20	NBC,VIL
CO4-EF-04132018-01	PCB 128/166	pg/L	15.3	3.12	101	J,JA,NBC,VIL,VJ,VIU
CO4-EF-04132018-01	PCB 129/138/163	pg/L	202	4.13	201	NBC,VIL,VJ,VIU
CO4-EF-04132018-01	PCB 132	pg/L	43.2	3.6	50	J,NBC,VIL,VIU
CO4-EF-04132018-01	PCB 135/151/154	pg/L	57	2.64	101	VRIU,J,NBC,VIL,VJ
CO4-EF-04132018-01	PCB 141	pg/L	36	3.12	50	VRIU,J,NBC,VIL,VJ
CO4-EF-04132018-01	PCB 147/149	pg/L	126	2.97	101	NBC,VIL,VJ,VIU
CO4-EF-04132018-01	PCB 153/168	pg/L	151	2.64	101	VIP,NBC,VIL,VJ,VIU
CO4-EF-04132018-01	PCB 156/157	pg/L	17.2	6.85	40	J,NBC,VIU
CO4-EF-04132018-01	PCB 158	pg/L	15.7	2.33	50	VRIU,J,NBC,VIL,VJ

Appendix G: Water Quality Data

Sample ID	Analyte Name	Unit Name	Result	MDL	RL	QA Code
CO4-EF-04132018-01	PCB 170	pg/L	66.3	5.84	50	NBC,VIL,VJ,VIU
CO4-EF-04132018-01	PCB 174	pg/L	65.4	4.13	50	NBC,VIL,VJ,VIU
CO4-EF-04132018-01	PCB 177	pg/L	39	4.57	50	J,NBC,VIL,VJ,VIU
CO4-EF-04132018-01	PCB 180/193	pg/L	166	4.41	101	NBC,VIL,VJ,VIU
CO4-EF-04132018-01	PCB 183/185	pg/L	51.6	4.29	101	J,NBC,VIL,VJ,VIU
CO4-EF-04132018-01	PCB 187	pg/L	80.7	2.88	50	NBC,VIL,VJ,VIU
CO4-EF-04132018-01	PCB 194	pg/L	41.1	8.32	50	J,JA,NBC,VIL,VJ
CO4-EF-04132018-01	PCB 195	pg/L	19.2	7.16	50	J,JA,NBC,VIL,VJ,VIU
CO4-EF-04132018-01	PCB 201	pg/L	5.22	3.67	50	VRIU,J,JA,NBC,VIL,VJ
CO4-EF-04132018-01	PCB 203	pg/L	32.6	6.03	50	J,NBC,VIL,VJ,VIU
CO4-EF-04132018-01	Total DiCB	pg/L	47.3	1.41	20	NBC,VIL,VJ
CO4-EF-04132018-01	Total HeptaCB	pg/L	417	2.88	20	NBC,VIL,VJ
CO4-EF-04132018-01	Total HexaCB	pg/L	663	2.33	20	VIP,NBC,VIL,VJ
CO4-EF-04132018-01	Total MonoCB	pg/L		20.1	20	NBC
CO4-EF-04132018-01	Total NonaCB	pg/L		20.1	20	NBC
CO4-EF-04132018-01	Total OctaCB	pg/L	98.1	3.67	20	NBC,VIL,VJ
CO4-EF-04132018-01	Total PCBs	pg/L	2310	1.41	201	VIP,NBC,VIL,VJ
CO4-EF-04132018-01	Total PentaCB	pg/L	416	2.89	201	NBC,VIL
CO4-EF-04132018-01	Total TetraCB	pg/L	379	2.2	201	NBC,VIL
CO4-EF-04132018-01	Total TriCB	pg/L	243	3.95	50	NBC,VIL
CO5-EF-04132018-01	PCB 008	pg/L	32.3	0.6	49	J,NBC,VIL,VJ
CO5-EF-04132018-01	PCB 018/30	pg/L	53.6	2.72	49	NBC
CO5-EF-04132018-01	PCB 020/28	pg/L	75.2	2.82	49	NBC
CO5-EF-04132018-01	PCB 021/33	pg/L	38	2.88	49	J,NBC
CO5-EF-04132018-01	PCB 031	pg/L	60.8	2.63	49	NBC
CO5-EF-04132018-01	PCB 044/47/65	pg/L	71.9	1.68	98	J,NBC,VIU
CO5-EF-04132018-01	PCB 049/69	pg/L	39.3	1.59	98	J,NBC,VIU
CO5-EF-04132018-01	PCB 052	pg/L	98	1.63	49	NBC,VIL,VIU
CO5-EF-04132018-01	PCB 056	pg/L	15.5	4.5	49	J,JA,NBC
CO5-EF-04132018-01	PCB 060	pg/L	12.6	4.42	49	J,NBC
CO5-EF-04132018-01	PCB 066	pg/L	37	1.36	49	J,NBC,VIU
CO5-EF-04132018-01	PCB 070/61/74/76	pg/L	82.3	1.45	196	J,NBC,VIL,VIU,VJ
CO5-EF-04132018-01	PCB 083/99	pg/L	58.8	2.74	98	J,NBC,VIL,VJ,VIU
CO5-EF-04132018-01	PCB 086/87/97/109/119/125	pg/L	55.3	2.39	196	J,NBC,VIL,VIU
CO5-EF-04132018-01	PCB 090/101/113	pg/L	82.6	2.36	196	J,NBC,VIL,VIU
CO5-EF-04132018-01	PCB 093/95/100	pg/L	69.7	1.64	196	J,NBC,VIL,VIU
CO5-EF-04132018-01	PCB 105	pg/L	27.8	3.43	20	NBC,VIU
CO5-EF-04132018-01	PCB 110/115	pg/L	80.2	2.17	98	J,NBC
CO5-EF-04132018-01	PCB 118	pg/L	61	3.07	20	NBC,VIL
CO5-EF-04132018-01	PCB 128/166	pg/L	22.6	1.78	98	J,NBC,VIL,VJ,VIU
CO5-EF-04132018-01	PCB 129/138/163	pg/L	215	2.36	196	NBC,VIL,VJ,VIU
CO5-EF-04132018-01	PCB 132	pg/L	28.4	2.06	49	J,NBC,VIL,VIU
CO5-EF-04132018-01	PCB 135/151/154	pg/L	84.6	1.64	98	VRIU,J,NBC,VIL,VJ
CO5-EF-04132018-01	PCB 141	pg/L	21.7	1.78	49	VRIU,J,NBC,VIL,VJ
CO5-EF-04132018-01	PCB 147/149	pg/L	93.2	1.7	98	J,NBC,VIL,VJ,VIU
CO5-EF-04132018-01	PCB 153/168	pg/L	507	1.51	98	VIP,NBC,VIL,VJ,VIU

Appendix G: Water Quality Data

Sample ID	Analyte Name	Unit Name	Result	MDL	RL	QA Code
CO5-EF-04132018-01	PCB 156/157	pg/L	13.5	5.87	39	J,NBC,VIU
CO5-EF-04132018-01	PCB 158	pg/L	12.6	1.33	49	VRIU,J,NBC,VIL,VJ
CO5-EF-04132018-01	PCB 170	pg/L	80.7	4.59	49	NBC,VIL,VJ,VIU
CO5-EF-04132018-01	PCB 174	pg/L	31.4	3.25	49	J,NBC,VIL,VJ,VIU
CO5-EF-04132018-01	PCB 177	pg/L	33.7	3.59	49	J,NBC,VIL,VJ,VIU
CO5-EF-04132018-01	PCB 180/193	pg/L	252	3.47	98	NBC,VIL,VJ,VIU
CO5-EF-04132018-01	PCB 183/185	pg/L	73.2	3.38	98	J,NBC,VIL,VJ,VIU
CO5-EF-04132018-01	PCB 187	pg/L	221	1.71	49	NBC,VIL,VJ,VIU
CO5-EF-04132018-01	PCB 194	pg/L	98.8	6.97	49	NBC,VIL,VJ
CO5-EF-04132018-01	PCB 195	pg/L	24.7	6	49	J,JA,NBC,VIL,VJ,VIU
CO5-EF-04132018-01	PCB 201	pg/L	8.22	3.08	49	VRIU,J,NBC,VIL,VJ
CO5-EF-04132018-01	PCB 203	pg/L	45	5.06	49	J,NBC,VIL,VJ,VIU
CO5-EF-04132018-01	Total DiCB	pg/L	32.3	0.6	20	NBC,VIL,VJ
CO5-EF-04132018-01	Total HeptaCB	pg/L	618	1.71	20	NBC,VIL,VJ
CO5-EF-04132018-01	Total HexaCB	pg/L	999	1.33	20	VIP,NBC,VIL,VJ
CO5-EF-04132018-01	Total MonoCB	pg/L		19.6	20	NBC
CO5-EF-04132018-01	Total NonaCB	pg/L		19.6	20	NBC
CO5-EF-04132018-01	Total OctaCB	pg/L	177	3.08	20	NBC,VIL,VJ
CO5-EF-04132018-01	Total PCBs	pg/L	2920	0.6	196	VIP,NBC,VIL,VJ
CO5-EF-04132018-01	Total PentaCB	pg/L	435	1.64	196	NBC,VIL
CO5-EF-04132018-01	Total TetraCB	pg/L	357	1.36	196	NBC,VIL
CO5-EF-04132018-01	Total TriCB	pg/L	228	2.63	49	NBC,VIL
CO6-EF-04132018-01	PCB 008	pg/L	52.5	1.12	48	NBC,VIL,VJ
CO6-EF-04132018-01	PCB 018/30	pg/L	82.9	3.3	48	NBC
CO6-EF-04132018-01	PCB 020/28	pg/L	105	5.3	48	NBC
CO6-EF-04132018-01	PCB 021/33	pg/L	54.1	5.41	48	NBC
CO6-EF-04132018-01	PCB 031	pg/L	80.7	4.94	48	NBC
CO6-EF-04132018-01	PCB 044/47/65	pg/L	145	3.11	97	NBC,VIU
CO6-EF-04132018-01	PCB 049/69	pg/L	96.4	2.95	97	J,NBC,VIU
CO6-EF-04132018-01	PCB 052	pg/L	264	3.03	48	NBC,VIL,VIU
CO6-EF-04132018-01	PCB 056	pg/L	22.8	4.1	48	J,NBC
CO6-EF-04132018-01	PCB 060	pg/L	14	4.03	48	J,NBC
CO6-EF-04132018-01	PCB 066	pg/L	43.1	2.52	48	J,NBC,VIU
CO6-EF-04132018-01	PCB 070/61/74/76	pg/L	94	2.7	193	J,NBC,VIL,VIU,VJ
CO6-EF-04132018-01	PCB 083/99	pg/L	146	2.94	97	NBC,VIL,VJ,VIU
CO6-EF-04132018-01	PCB 086/87/97/109/119/125	pg/L	74.2	2.57	193	J,NBC,VIL,VIU
CO6-EF-04132018-01	PCB 090/101/113	pg/L	157	2.54	193	J,NBC,VIL,VIU
CO6-EF-04132018-01	PCB 093/95/100	pg/L	175	2.24	193	J,NBC,VIL,VIU
CO6-EF-04132018-01	PCB 105	pg/L	30.1	5.13	19	NBC,VIU
CO6-EF-04132018-01	PCB 110/115	pg/L	87.3	2.33	97	J,NBC
CO6-EF-04132018-01	PCB 118	pg/L	72.4	4.41	19	NBC,VIL
CO6-EF-04132018-01	PCB 128/166	pg/L	26.6	3.31	97	J,NBC,VIL,VJ,VIU
CO6-EF-04132018-01	PCB 129/138/163	pg/L	284	4.39	193	NBC,VIL,VJ,VIU
CO6-EF-04132018-01	PCB 132	pg/L	33.2	3.82	48	J,NBC,VIL,VIU
CO6-EF-04132018-01	PCB 135/151/154	pg/L	221	1.5	97	VRIU,NBC,VIL,VJ
CO6-EF-04132018-01	PCB 141	pg/L	28.2	3.32	48	VRIU,J,NBC,VIL,VJ

Appendix G: Water Quality Data

Sample ID	Analyte Name	Unit Name	Result	MDL	RL	QA Code
CO6-EF-04132018-01	PCB 147/149	pg/L	157	3.15	97	NBC,VIL,VJ,VIU
CO6-EF-04132018-01	PCB 153/168	pg/L	926	2.81	97	VIP,NBC,VIL,VJ,VIU
CO6-EF-04132018-01	PCB 156/157	pg/L	17.7	5.92	39	J,NBC,VIU
CO6-EF-04132018-01	PCB 158	pg/L	16.6	2.48	48	VRIU,J,NBC,VIL,VJ
CO6-EF-04132018-01	PCB 170	pg/L	93	4.17	48	NBC,VIL,VJ,VIU
CO6-EF-04132018-01	PCB 174	pg/L	36.3	2.95	48	J,NBC,VIL,VJ,VIU
CO6-EF-04132018-01	PCB 177	pg/L	45.7	3.26	48	J,NBC,VIL,VJ,VIU
CO6-EF-04132018-01	PCB 180/193	pg/L	328	3.15	97	NBC,VIL,VJ,VIU
CO6-EF-04132018-01	PCB 183/185	pg/L	104	3.06	97	NBC,VIL,VJ,VIU
CO6-EF-04132018-01	PCB 187	pg/L	357	1.75	48	NBC,VIL,VJ,VIU
CO6-EF-04132018-01	PCB 194	pg/L	113	5.23	48	NBC,VIL,VJ
CO6-EF-04132018-01	PCB 195	pg/L	28.4	4.5	48	J,NBC,VIL,VJ,VIU
CO6-EF-04132018-01	PCB 201	pg/L	13.9	2.31	48	VRIU,J,NBC,VIL,VJ
CO6-EF-04132018-01	PCB 203	pg/L	51.9	3.79	48	NBC,VIL,VJ,VIU
CO6-EF-04132018-01	Total DiCB	pg/L	52.5	1.12	19	NBC,VIL,VJ
CO6-EF-04132018-01	Total HeptaCB	pg/L	859	1.75	19	NBC,VIL,VJ
CO6-EF-04132018-01	Total HexaCB	pg/L	1710	1.5	19	VIP,NBC,VIL,VJ
CO6-EF-04132018-01	Total MonoCB	pg/L		19.3	19	NBC
CO6-EF-04132018-01	Total NonaCB	pg/L		19.3	19	NBC
CO6-EF-04132018-01	Total OctaCB	pg/L	207	2.31	19	NBC,VIL,VJ
CO6-EF-04132018-01	Total PCBs	pg/L	4680	1.12	193	VIP,NBC,VIL,VJ
CO6-EF-04132018-01	Total PentaCB	pg/L	742	2.24	193	NBC,VIL
CO6-EF-04132018-01	Total TetraCB	pg/L	680	2.52	193	NBC,VIL
CO6-EF-04132018-01	Total TriCB	pg/L	323	3.3	48	NBC,VIL
TW2-IN-04132018-01	PCB 008	pg/L	81.6	1.5	48	NBC,VIL,VJ
TW2-IN-04132018-01	PCB 018/30	pg/L	111	3.77	48	NBC
TW2-IN-04132018-01	PCB 020/28	pg/L	311	7.05	48	NBC
TW2-IN-04132018-01	PCB 021/33	pg/L	214	7.23	48	NBC
TW2-IN-04132018-01	PCB 031	pg/L	252	6.63	48	NBC
TW2-IN-04132018-01	PCB 044/47/65	pg/L	340	9.11	96	NBC,VIU
TW2-IN-04132018-01	PCB 049/69	pg/L	173	8.61	96	NBC,VIU
TW2-IN-04132018-01	PCB 052	pg/L	330	8.88	48	NBC,VIL,VIU
TW2-IN-04132018-01	PCB 056	pg/L	167	3.54	48	NBC
TW2-IN-04132018-01	PCB 060	pg/L	92.1	3.37	48	NBC
TW2-IN-04132018-01	PCB 066	pg/L	302	7.66	48	NBC,VIU
TW2-IN-04132018-01	PCB 070/61/74/76	pg/L	664	8.02	192	NBC,VIL,VIU,VJ
TW2-IN-04132018-01	PCB 083/99	pg/L	351	4.32	96	NBC,VIL,VJ,VIU
TW2-IN-04132018-01	PCB 086/87/97/109/119/125	pg/L	529	3.77	192	NBC,VIL,VIU
TW2-IN-04132018-01	PCB 090/101/113	pg/L	641	3.75	192	NBC,VIL,VIU
TW2-IN-04132018-01	PCB 093/95/100	pg/L	401	4.01	192	NBC,VIL,VIU
TW2-IN-04132018-01	PCB 105	pg/L	356	3.83	19	NBC,VIU
TW2-IN-04132018-01	PCB 110/115	pg/L	906	3.42	96	NBC
TW2-IN-04132018-01	PCB 118	pg/L	728	3.52	19	NBC,VIL
TW2-IN-04132018-01	PCB 128/166	pg/L	219	2.04	96	NBC,VIL,VJ,VIU
TW2-IN-04132018-01	PCB 129/138/163	pg/L	2070	2.81	192	VIP,NBC,VIL,VJ,VIU
TW2-IN-04132018-01	PCB 132	pg/L	388	2.49	48	NBC,VIL,VIU

Appendix G: Water Quality Data

Sample ID	Analyte Name	Unit Name	Result	MDL	RL	QA Code
TW2-IN-04132018-01	PCB 135/151/154	pg/L	445	1.95	96	VRIU,NBC,VIL,VJ
TW2-IN-04132018-01	PCB 141	pg/L	256	2.15	48	VRIU,NBC,VIL,VJ
TW2-IN-04132018-01	PCB 147/149	pg/L	860	2.12	96	NBC,VIL,VJ,VIU
TW2-IN-04132018-01	PCB 153/168	pg/L	2170	1.82	96	VIP,NBC,VIL,VJ,VIU
TW2-IN-04132018-01	PCB 156/157	pg/L	175	6.64	38	NBC,VIU
TW2-IN-04132018-01	PCB 158	pg/L	142	1.57	48	VRIU,NBC,VIL,VJ
TW2-IN-04132018-01	PCB 170	pg/L	548	3.84	48	NBC,VIL,VJ,VIU
TW2-IN-04132018-01	PCB 174	pg/L	380	3.19	48	NBC,VIL,VJ,VIU
TW2-IN-04132018-01	PCB 177	pg/L	271	3.44	48	NBC,VIL,VJ,VIU
TW2-IN-04132018-01	PCB 180/193	pg/L	1490	3.02	96	NBC,VIL,VJ,VIU
TW2-IN-04132018-01	PCB 183/185	pg/L	434	3.3	96	NBC,VIL,VJ,VIU
TW2-IN-04132018-01	PCB 187	pg/L	1030	1.76	48	NBC,VIL,VJ,VIU
TW2-IN-04132018-01	PCB 194	pg/L	367	3.01	48	VIP,NBC,VIL,VJ
TW2-IN-04132018-01	PCB 195	pg/L	107	3.16	48	NBC,VIL,VJ,VIU
TW2-IN-04132018-01	PCB 201	pg/L	46.2	2.03	48	VRIU,J,NBC,VIL,VJ
TW2-IN-04132018-01	PCB 203	pg/L	227	2.87	48	NBC,VIL,VJ,VIU
TW2-IN-04132018-01	Total DiCB	pg/L	81.6	1.5	19	NBC,VIL,VJ
TW2-IN-04132018-01	Total HeptaCB	pg/L	3720	1.76	19	NBC,VIL,VJ
TW2-IN-04132018-01	Total HexaCB	pg/L	6720	1.57	19	VIP,NBC,VIL,VJ
TW2-IN-04132018-01	Total MonoCB	pg/L		19.2	19	NBC
TW2-IN-04132018-01	Total NonaCB	pg/L		19.2	19	NBC
TW2-IN-04132018-01	Total OctaCB	pg/L	747	2.03	19	VIP,NBC,VIL,VJ
TW2-IN-04132018-01	Total PCBs	pg/L	18600	1.5	192	VIP,NBC,VIL,VJ
TW2-IN-04132018-01	Total PentaCB	pg/L	3910	3.42	192	NBC,VIL
TW2-IN-04132018-01	Total TetraCB	pg/L	2070	3.37	192	NBC,VIL
TW2-IN-04132018-01	Total TriCB	pg/L	889	3.77	48	NBC,VIL
BLNK-EF-04172018-01	PCB 008	pg/L	13.7	1.82	48	J,NBC,VIL,VJ
BLNK-EF-04172018-01	PCB 018/30	pg/L	10.7	5.11	48	J,JA,NBC
BLNK-EF-04172018-01	PCB 020/28	pg/L	17.4	6.17	48	J,NBC
BLNK-EF-04172018-01	PCB 021/33	pg/L	12.8	6.3	48	J,NBC
BLNK-EF-04172018-01	PCB 031	pg/L	14.9	5.76	48	J,NBC
BLNK-EF-04172018-01	PCB 044/47/65	pg/L	37.3	4.52	95	J,NBC,VIU
BLNK-EF-04172018-01	PCB 049/69	pg/L	14.7	4.28	95	J,NBC,VIU
BLNK-EF-04172018-01	PCB 052	pg/L	52.6	4.39	48	NBC,VIL,VIU
BLNK-EF-04172018-01	PCB 056	pg/L		4.76	48	NBC
BLNK-EF-04172018-01	PCB 060	pg/L		4.68	48	NBC
BLNK-EF-04172018-01	PCB 066	pg/L	5.97	3.65	48	J,JA,NBC,VIU
BLNK-EF-04172018-01	PCB 070/61/74/76	pg/L	14.9	3.92	190	J,NBC,VIL,VIU,VJ
BLNK-EF-04172018-01	PCB 083/99	pg/L	10.9	6.88	95	J,JA,NBC,VIL,VJ,VIU
BLNK-EF-04172018-01	PCB 086/87/97/109/119/125	pg/L		6.01	190	NBC,VIL,VIU
BLNK-EF-04172018-01	PCB 090/101/113	pg/L	22.7	5.93	190	J,NBC,VIL,VIU
BLNK-EF-04172018-01	PCB 093/95/100	pg/L	26.9	5.98	190	J,NBC,VIL,VIU
BLNK-EF-04172018-01	PCB 105	pg/L		5.78	19	NBC,VIU
BLNK-EF-04172018-01	PCB 110/115	pg/L	13.8	5.45	95	J,JA,NBC
BLNK-EF-04172018-01	PCB 118	pg/L		5.31	19	NBC,VIL
BLNK-EF-04172018-01	PCB 128/166	pg/L		5.28	95	NBC,VIL,VJ,VIU

Appendix G: Water Quality Data

Sample ID	Analyte Name	Unit Name	Result	MDL	RL	QA Code
BLNK-EF-04172018-01	PCB 129/138/163	pg/L	17.1	6.99	190	J,NBC,VIL,VJ,VIU
BLNK-EF-04172018-01	PCB 132	pg/L		6.08	48	NBC,VIL,VIU
BLNK-EF-04172018-01	PCB 135/151/154	pg/L	10.1	3.04	95	VRIU,J,JA,NBC,VIL,VJ
BLNK-EF-04172018-01	PCB 141	pg/L		5.28	48	VRIU,NBC,VIL,VJ
BLNK-EF-04172018-01	PCB 147/149	pg/L	13.6	5.02	95	J,NBC,VIL,VJ,VIU
BLNK-EF-04172018-01	PCB 153/168	pg/L	20.6	4.47	95	IP,J,JA,NBC,VIL,VJ,VIU
BLNK-EF-04172018-01	PCB 156/157	pg/L		6.97	38	NBC,VIU
BLNK-EF-04172018-01	PCB 158	pg/L		3.94	48	VRIU,NBC,VIL,VJ
BLNK-EF-04172018-01	PCB 170	pg/L		8.48	48	NBC,VIL,VJ,VIU
BLNK-EF-04172018-01	PCB 174	pg/L		5.99	48	NBC,VIL,VJ,VIU
BLNK-EF-04172018-01	PCB 177	pg/L		6.63	48	NBC,VIL,VJ,VIU
BLNK-EF-04172018-01	PCB 180/193	pg/L	13.7	6.41	95	J,NBC,VIL,VJ,VIU
BLNK-EF-04172018-01	PCB 183/185	pg/L		6.23	95	NBC,VIL,VJ,VIU
BLNK-EF-04172018-01	PCB 187	pg/L	8.14	4.81	48	J,NBC,VIL,VJ,VIU
BLNK-EF-04172018-01	PCB 194	pg/L		8.64	48	NBC,VIL,VJ
BLNK-EF-04172018-01	PCB 195	pg/L		7.44	48	NBC,VIL,VJ,VIU
BLNK-EF-04172018-01	PCB 201	pg/L		3.81	48	VRIU,NBC,VIL,VJ
BLNK-EF-04172018-01	PCB 203	pg/L		6.26	48	NBC,VIL,VJ,VIU
BLNK-EF-04172018-01	Total DiCB	pg/L	13.7	1.82	19	J,NBC,VIL,VJ
BLNK-EF-04172018-01	Total HeptaCB	pg/L	21.9	4.81	19	NBC,VIL,VJ
BLNK-EF-04172018-01	Total HexaCB	pg/L	61.4	3.04	19	VIP,NBC,VIL,VJ
BLNK-EF-04172018-01	Total MonoCB	pg/L		19	19	NBC
BLNK-EF-04172018-01	Total NonaCB	pg/L		19	19	NBC
BLNK-EF-04172018-01	Total OctaCB	pg/L		3.81	19	NBC,VIL,VJ
BLNK-EF-04172018-01	Total PCBs	pg/L	353	1.82	190	VIP,NBC,VIL,VJ
BLNK-EF-04172018-01	Total PentaCB	pg/L	74.4	5.31	190	J,NBC,VIL
BLNK-EF-04172018-01	Total TetraCB	pg/L	126	3.65	190	J,NBC,VIL
BLNK-EF-04172018-01	Total TriCB	pg/L	55.7	5.11	48	NBC,VIL
CO1-EF-04172018-01	PCB 008	pg/L		61.9	62	NBC,VIL,VJ
CO1-EF-04172018-01	PCB 018/30	pg/L		84.4	84	NBC
CO1-EF-04172018-01	PCB 020/28	pg/L		103	103	NBC
CO1-EF-04172018-01	PCB 021/33	pg/L		106	106	NBC
CO1-EF-04172018-01	PCB 031	pg/L		96.5	97	NBC
CO1-EF-04172018-01	PCB 044/47/65	pg/L		96.1	99	NBC,VIU
CO1-EF-04172018-01	PCB 049/69	pg/L		90.9	99	NBC,VIU
CO1-EF-04172018-01	PCB 052	pg/L		93.7	94	NBC,VIL,VIU
CO1-EF-04172018-01	PCB 056	pg/L		44.9	50	NBC
CO1-EF-04172018-01	PCB 060	pg/L		42.7	50	NBC
CO1-EF-04172018-01	PCB 066	pg/L		80.8	81	NBC,VIU
CO1-EF-04172018-01	PCB 070/61/74/76	pg/L		84.6	199	NBC,VIL,VIU,VJ
CO1-EF-04172018-01	PCB 083/99	pg/L		32.4	99	NBC,VIL,VJ,VIU
CO1-EF-04172018-01	PCB 086/87/97/109/119/125	pg/L		28.3	199	NBC,VIL,VIU
CO1-EF-04172018-01	PCB 090/101/113	pg/L	47.8	28.1	199	J,NBC,VIL,VIU
CO1-EF-04172018-01	PCB 093/95/100	pg/L		40.1	199	NBC,VIL,VIU
CO1-EF-04172018-01	PCB 105	pg/L		23	23	NBC,VIU
CO1-EF-04172018-01	PCB 110/115	pg/L	49.6	25.7	99	J,NBC

Appendix G: Water Quality Data

Sample ID	Analyte Name	Unit Name	Result	MDL	RL	QA Code
CO1-EF-04172018-01	PCB 118	pg/L		24.1	24	NBC,VIL
CO1-EF-04172018-01	PCB 128/166	pg/L		14.8	99	NBC,VIL,VJ,VIU
CO1-EF-04172018-01	PCB 129/138/163	pg/L	95.2	20.3	199	IP,J,NBC,VIL,VJ,VIU
CO1-EF-04172018-01	PCB 132	pg/L		18	50	NBC,VIL,VIU
CO1-EF-04172018-01	PCB 135/151/154	pg/L		15.2	99	VRIU,NBC,VIL,VJ
CO1-EF-04172018-01	PCB 141	pg/L		15.5	50	VRIU,NBC,VIL,VJ
CO1-EF-04172018-01	PCB 147/149	pg/L		15.3	99	NBC,VIL,VJ,VIU
CO1-EF-04172018-01	PCB 153/168	pg/L	92	13.2	99	IP,J,NBC,VIL,VJ,VIU
CO1-EF-04172018-01	PCB 156/157	pg/L		26.3	40	NBC,VIU
CO1-EF-04172018-01	PCB 158	pg/L		11.4	50	VRIU,NBC,VIL,VJ
CO1-EF-04172018-01	PCB 170	pg/L		38.5	50	NBC,VIL,VJ,VIU
CO1-EF-04172018-01	PCB 174	pg/L		31.9	50	NBC,VIL,VJ,VIU
CO1-EF-04172018-01	PCB 177	pg/L		34.5	50	NBC,VIL,VJ,VIU
CO1-EF-04172018-01	PCB 180/193	pg/L	61.2	30.3	99	J,JA,NBC,VIL,VJ,VIU
CO1-EF-04172018-01	PCB 183/185	pg/L		33	99	NBC,VIL,VJ,VIU
CO1-EF-04172018-01	PCB 187	pg/L	36.9	16.1	50	J,NBC,VIL,VJ,VIU
CO1-EF-04172018-01	PCB 194	pg/L		22.2	50	VRIP,NBC,VIL,VJ
CO1-EF-04172018-01	PCB 195	pg/L		23.4	50	NBC,VIL,VJ,VIU
CO1-EF-04172018-01	PCB 201	pg/L		15	50	VRIU,NBC,VIL,VJ
CO1-EF-04172018-01	PCB 203	pg/L		21.2	50	NBC,VIL,VJ,VIU
CO1-EF-04172018-01	Total DiCB	pg/L		61.9	62	NBC,VIL,VJ
CO1-EF-04172018-01	Total HeptaCB	pg/L	98.1	16.1	20	NBC,VIL,VJ
CO1-EF-04172018-01	Total HexaCB	pg/L	187	11.4	20	VIP,NBC,VIL,VJ
CO1-EF-04172018-01	Total MonoCB	pg/L		19.9	20	NBC
CO1-EF-04172018-01	Total NonaCB	pg/L		19.9	20	NBC
CO1-EF-04172018-01	Total OctaCB	pg/L		15	20	VRIP,NBC,VIL,VJ
CO1-EF-04172018-01	Total PCBs	pg/L	383	11.4	199	VIP,NBC,VIL,VJ
CO1-EF-04172018-01	Total PentaCB	pg/L	97.4	23	199	J,NBC,VIL
CO1-EF-04172018-01	Total TetraCB	pg/L		42.7	199	NBC,VIL
CO1-EF-04172018-01	Total TriCB	pg/L		84.4	84	NBC,VIL
CO2-EF-04172018-01	PCB 008	pg/L	35.5	3.22	48	J,NBC,VIL,VJ
CO2-EF-04172018-D	PCB 008	pg/L	10.9	1.78	49	J,NBC,VIL,VJ
CO2-EF-04172018-01	PCB 018/30	pg/L	14.9	5.25	48	J,NBC
CO2-EF-04172018-D	PCB 018/30	pg/L	9.84	5.62	49	J,NBC
CO2-EF-04172018-01	PCB 020/28	pg/L	20	13.2	48	J,JA,NBC
CO2-EF-04172018-D	PCB 020/28	pg/L	15.6	8.61	49	J,NBC
CO2-EF-04172018-01	PCB 021/33	pg/L		13.5	48	NBC
CO2-EF-04172018-D	PCB 021/33	pg/L		8.54	49	NBC
CO2-EF-04172018-01	PCB 031	pg/L	14.4	12.4	48	J,NBC
CO2-EF-04172018-D	PCB 031	pg/L		8.22	49	NBC
CO2-EF-04172018-01	PCB 044/47/65	pg/L	34.6	8.19	96	J,NBC,VIU
CO2-EF-04172018-D	PCB 044/47/65	pg/L	27.7	6.27	98	J,NBC,VIU
CO2-EF-04172018-01	PCB 049/69	pg/L	20.2	7.75	96	J,JA,NBC,VIU
CO2-EF-04172018-D	PCB 049/69	pg/L	9.7	6.09	98	J,NBC,VIU
CO2-EF-04172018-01	PCB 052	pg/L	38.7	7.98	48	J,NBC,VIL,VIU
CO2-EF-04172018-D	PCB 052	pg/L	20	6.72	49	J,NBC,VIL,VIU

Appendix G: Water Quality Data

Sample ID	Analyte Name	Unit Name	Result	MDL	RL	QA Code
CO2-EF-04172018-01	PCB 056	pg/L		17.3	48	NBC
CO2-EF-04172018-D	PCB 056	pg/L		4.36	49	NBC
CO2-EF-04172018-01	PCB 060	pg/L		16.5	48	NBC
CO2-EF-04172018-D	PCB 060	pg/L		4.03	49	NBC
CO2-EF-04172018-01	PCB 066	pg/L	15.4	6.89	48	J,NBC,VIU
CO2-EF-04172018-D	PCB 066	pg/L	7.41	4.39	49	J,NBC,VIU
CO2-EF-04172018-01	PCB 070/61/74/76	pg/L	32.3	7.21	192	J,NBC,VIL,VIU,VJ
CO2-EF-04172018-D	PCB 070/61/74/76	pg/L	18.2	4.76	195	J,JA,NBC,VIL,VIU,VJ
CO2-EF-04172018-01	PCB 083/99	pg/L	73.6	4.1	96	J,NBC,VIL,VJ,VIU
CO2-EF-04172018-D	PCB 083/99	pg/L	11.3	3.35	98	J,JA,NBC,VIL,VJ,VIU
CO2-EF-04172018-01	PCB 086/87/97/109/119/125	pg/L	38.1	3.58	192	J,NBC,VIL,VIU
CO2-EF-04172018-D	PCB 086/87/97/109/119/125	pg/L	22.2	2.87	195	J,NBC,VIL,VIU
CO2-EF-04172018-01	PCB 090/101/113	pg/L	60.7	3.56	192	J,NBC,VIL,VIU
CO2-EF-04172018-D	PCB 090/101/113	pg/L	22.1	2.95	195	J,NBC,VIL,VIU
CO2-EF-04172018-01	PCB 093/95/100	pg/L	44.5	3.08	192	J,NBC,VIL,VIU
CO2-EF-04172018-D	PCB 093/95/100	pg/L	15.9	3.61	195	J,NBC,VIL,VIU
CO2-EF-04172018-01	PCB 105	pg/L		12.7	19	NBC,VIU
CO2-EF-04172018-D	PCB 105	pg/L	7.29	4.52	20	J,JA,NBC,VIU
CO2-EF-04172018-01	PCB 110/115	pg/L	34	3.25	96	J,NBC
CO2-EF-04172018-D	PCB 110/115	pg/L	25.8	2.55	98	J,NBC
CO2-EF-04172018-01	PCB 118	pg/L	42.7	12	19	NBC,VIL
CO2-EF-04172018-D	PCB 118	pg/L	14.8	4.15	20	J,NBC,VIL
CO2-EF-04172018-01	PCB 128/166	pg/L	33	2.49	96	J,NBC,VIL,VJ,VIU
CO2-EF-04172018-D	PCB 128/166	pg/L	5.12	1.81	98	J,JA,NBC,VIL,VJ,VIU
CO2-EF-04172018-01	PCB 129/138/163	pg/L	367	3.43	192	VIP,NBC,VIL,VJ,VIU
CO2-EF-04172018-D	PCB 129/138/163	pg/L	36.1	2.6	195	IP,J,NBC,VIL,VJ,VIU
CO2-EF-04172018-01	PCB 132	pg/L	22.5	3.04	48	J,NBC,VIL,VIU
CO2-EF-04172018-D	PCB 132	pg/L	10.2	2.43	49	J,NBC,VIL,VIU
CO2-EF-04172018-01	PCB 135/151/154	pg/L	149	2.25	96	VRIU,NBC,VIL,VJ
CO2-EF-04172018-D	PCB 135/151/154	pg/L	11.8	2.28	98	VRIU,J,NBC,VIL,VJ
CO2-EF-04172018-01	PCB 141	pg/L	30.6	2.62	48	VRIU,J,NBC,VIL,VJ
CO2-EF-04172018-D	PCB 141	pg/L	5.88	1.98	49	VRIU,J,NBC,VIL,VJ
CO2-EF-04172018-01	PCB 147/149	pg/L	120	2.59	96	NBC,VIL,VJ,VIU
CO2-EF-04172018-D	PCB 147/149	pg/L	20.5	2.13	98	J,NBC,VIL,VJ,VIU
CO2-EF-04172018-01	PCB 153/168	pg/L	1190	2.22	96	VIP,NBC,VIL,VJ,VIU
CO2-EF-04172018-D	PCB 153/168	pg/L	24	1.71	98	VRIP,IP,J,NBC,VIL,VJ,VIU
CO2-EF-04172018-01	PCB 156/157	pg/L	19.1	8.29	38	J,NBC,VIU
CO2-EF-04172018-D	PCB 156/157	pg/L	5.08	3.9	39	J,JA,NBC,VIU
CO2-EF-04172018-01	PCB 158	pg/L	19.8	1.92	48	VRIU,J,NBC,VIL,VJ
CO2-EF-04172018-D	PCB 158	pg/L	3.24	1.4	49	VRIU,J,NBC,VIL,VJ
CO2-EF-04172018-01	PCB 170	pg/L	185	3.98	48	NBC,VIL,VJ,VIU
CO2-EF-04172018-D	PCB 170	pg/L	6.79	3.44	49	J,NBC,VIL,VJ,VIU
CO2-EF-04172018-01	PCB 174	pg/L	48.3	3.3	48	NBC,VIL,VJ,VIU
CO2-EF-04172018-D	PCB 174	pg/L	7.59	3.29	49	J,NBC,VIL,VJ,VIU
CO2-EF-04172018-01	PCB 177	pg/L	78	3.57	48	NBC,VIL,VJ,VIU
CO2-EF-04172018-D	PCB 177	pg/L	4.44	3.32	49	J,NBC,VIL,VJ,VIU

Appendix G: Water Quality Data

Sample ID	Analyte Name	Unit Name	Result	MDL	RL	QA Code
CO2-EF-04172018-01	PCB 180/193	pg/L	608	3.13	96	NBC,VIL,VJ,VIU
CO2-EF-04172018-D	PCB 180/193	pg/L	17.2	2.84	98	J,NBC,VIL,VJ,VIU
CO2-EF-04172018-01	PCB 183/185	pg/L	174	3.42	96	NBC,VIL,VJ,VIU
CO2-EF-04172018-D	PCB 183/185	pg/L	7.22	3.3	98	J,NBC,VIL,VJ,VIU
CO2-EF-04172018-01	PCB 187	pg/L	585	2.28	48	NBC,VIL,VJ,VIU
CO2-EF-04172018-D	PCB 187	pg/L	9.87	2.25	49	J,NBC,VIL,VJ,VIU
CO2-EF-04172018-01	PCB 194	pg/L	203	2.9	48	VIP,NBC,VIL,VJ
CO2-EF-04172018-D	PCB 194	pg/L	5.75	2.75	49	VRIP,IP,J,JA,NBC,VIL,VJ
CO2-EF-04172018-01	PCB 195	pg/L	51.3	3.04	48	NBC,VIL,VJ,VIU
CO2-EF-04172018-D	PCB 195	pg/L	3.92	2.79	49	J,NBC,VIL,VJ,VIU
CO2-EF-04172018-01	PCB 201	pg/L	20.8	1.95	48	VRIU,J,NBC,VIL,VJ
CO2-EF-04172018-D	PCB 201	pg/L		1.99	49	VRIU,NBC,VIL,VJ
CO2-EF-04172018-01	PCB 203	pg/L	87.7	2.76	48	NBC,VIL,VJ,VIU
CO2-EF-04172018-D	PCB 203	pg/L	5.23	2.57	49	J,NBC,VIL,VJ,VIU
CO2-EF-04172018-01	Total DiCB	pg/L	35.5	3.22	19	NBC,VIL,VJ
CO2-EF-04172018-D	Total DiCB	pg/L	10.9	1.78	20	J,NBC,VIL,VJ
CO2-EF-04172018-01	Total HeptaCB	pg/L	1500	2.28	19	NBC,VIL,VJ
CO2-EF-04172018-D	Total HeptaCB	pg/L	45.9	2.25	20	NBC,VIL,VJ
CO2-EF-04172018-01	Total HexaCB	pg/L	1950	1.92	19	VIP,NBC,VIL,VJ
CO2-EF-04172018-D	Total HexaCB	pg/L	122	1.4	20	VIP,NBC,VIL,VJ
CO2-EF-04172018-01	Total MonoCB	pg/L		19.2	19	NBC
CO2-EF-04172018-D	Total MonoCB	pg/L		19.5	20	NBC
CO2-EF-04172018-01	Total NonaCB	pg/L		19.2	19	NBC
CO2-EF-04172018-D	Total NonaCB	pg/L		19.5	20	NBC
CO2-EF-04172018-01	Total OctaCB	pg/L	362	1.95	19	VIP,NBC,VIL,VJ
CO2-EF-04172018-D	Total OctaCB	pg/L	14.9	1.99	20	VRIP,J,NBC,VIL,VJ
CO2-EF-04172018-01	Total PCBs	pg/L	4510	1.92	192	VIP,NBC,VIL,VJ
CO2-EF-04172018-D	Total PCBs	pg/L	429	1.4	195	VIP,NBC,VIL,VJ
CO2-EF-04172018-01	Total PentaCB	pg/L	294	3.08	192	NBC,VIL
CO2-EF-04172018-D	Total PentaCB	pg/L	119	2.55	195	J,NBC,VIL
CO2-EF-04172018-01	Total TetraCB	pg/L	141	6.89	192	J,NBC,VIL
CO2-EF-04172018-D	Total TetraCB	pg/L	83	4.03	195	J,NBC,VIL
CO2-EF-04172018-01	Total TriCB	pg/L	49.3	5.25	48	NBC,VIL
CO2-EF-04172018-D	Total TriCB	pg/L	25.4	5.62	49	J,NBC,VIL
CO3-EF-04172018-01	PCB 008	pg/L		25.7	48	NBC,VIL,VJ
CO3-EF-04172018-01	PCB 018/30	pg/L		42.9	48	NBC
CO3-EF-04172018-01	PCB 020/28	pg/L		54.9	55	NBC
CO3-EF-04172018-01	PCB 021/33	pg/L		56.4	56	NBC
CO3-EF-04172018-01	PCB 031	pg/L		51.6	52	NBC
CO3-EF-04172018-01	PCB 044/47/65	pg/L		53.2	97	NBC,VIU
CO3-EF-04172018-01	PCB 049/69	pg/L		50.4	97	NBC,VIU
CO3-EF-04172018-01	PCB 052	pg/L		51.9	52	NBC,VIL,VIU
CO3-EF-04172018-01	PCB 056	pg/L		26.5	48	NBC
CO3-EF-04172018-01	PCB 060	pg/L		25.2	48	NBC
CO3-EF-04172018-01	PCB 066	pg/L		44.8	48	NBC,VIU
CO3-EF-04172018-01	PCB 070/61/74/76	pg/L		46.9	194	NBC,VIL,VIU,VJ

Appendix G: Water Quality Data

Sample ID	Analyte Name	Unit Name	Result	MDL	RL	QA Code
CO3-EF-04172018-01	PCB 083/99	pg/L		15.9	97	NBC,VIL,VJ,VIU
CO3-EF-04172018-01	PCB 086/87/97/109/119/125	pg/L		13.9	194	NBC,VIL,VIU
CO3-EF-04172018-01	PCB 090/101/113	pg/L	37.1	13.8	194	J,JA,NBC,VIL,VIU
CO3-EF-04172018-01	PCB 093/95/100	pg/L		23.4	194	NBC,VIL,VIU
CO3-EF-04172018-01	PCB 105	pg/L		16.9	19	NBC,VIU
CO3-EF-04172018-01	PCB 110/115	pg/L	54.1	12.6	97	J,NBC
CO3-EF-04172018-01	PCB 118	pg/L	38.7	17	19	NBC,VIL
CO3-EF-04172018-01	PCB 128/166	pg/L		8.58	97	NBC,VIL,VJ,VIU
CO3-EF-04172018-01	PCB 129/138/163	pg/L	69.9	11.9	194	IP,J,NBC,VIL,VJ,VIU
CO3-EF-04172018-01	PCB 132	pg/L		10.5	48	NBC,VIL,VIU
CO3-EF-04172018-01	PCB 135/151/154	pg/L	15.1	8.16	97	VRIU,J,JA,NBC,VIL,VJ
CO3-EF-04172018-01	PCB 141	pg/L		9.02	48	VRIU,NBC,VIL,VJ
CO3-EF-04172018-01	PCB 147/149	pg/L	17.9	8.91	97	J,JA,NBC,VIL,VJ,VIU
CO3-EF-04172018-01	PCB 153/168	pg/L	41.4	7.65	97	IP,J,NBC,VIL,VJ,VIU
CO3-EF-04172018-01	PCB 156/157	pg/L		11.9	39	NBC,VIU
CO3-EF-04172018-01	PCB 158	pg/L		6.6	48	VRIU,NBC,VIL,VJ
CO3-EF-04172018-01	PCB 170	pg/L	26	16	48	J,NBC,VIL,VJ,VIU
CO3-EF-04172018-01	PCB 174	pg/L	17.5	13.2	48	J,NBC,VIL,VJ,VIU
CO3-EF-04172018-01	PCB 177	pg/L		14.3	48	NBC,VIL,VJ,VIU
CO3-EF-04172018-01	PCB 180/193	pg/L	48.9	12.6	97	J,NBC,VIL,VJ,VIU
CO3-EF-04172018-01	PCB 183/185	pg/L		13.7	97	NBC,VIL,VJ,VIU
CO3-EF-04172018-01	PCB 187	pg/L	19.4	8.47	48	J,NBC,VIL,VJ,VIU
CO3-EF-04172018-01	PCB 194	pg/L	15.4	7.39	48	VRIP,IP,J,JA,NBC,VIL,VJ
CO3-EF-04172018-01	PCB 195	pg/L		7.77	48	NBC,VIL,VJ,VIU
CO3-EF-04172018-01	PCB 201	pg/L		4.98	48	VRIU,NBC,VIL,VJ
CO3-EF-04172018-01	PCB 203	pg/L	10	7.05	48	J,NBC,VIL,VJ,VIU
CO3-EF-04172018-01	Total DiCB	pg/L		25.7	26	NBC,VIL,VJ
CO3-EF-04172018-01	Total HeptaCB	pg/L	112	8.47	19	NBC,VIL,VJ
CO3-EF-04172018-01	Total HexaCB	pg/L	144	6.6	19	VIP,NBC,VIL,VJ
CO3-EF-04172018-01	Total MonoCB	pg/L		19.4	19	NBC
CO3-EF-04172018-01	Total NonaCB	pg/L		19.4	19	NBC
CO3-EF-04172018-01	Total OctaCB	pg/L	25.4	4.98	19	VRIP,NBC,VIL,VJ
CO3-EF-04172018-01	Total PCBs	pg/L	411	4.98	194	VIP,NBC,VIL,VJ
CO3-EF-04172018-01	Total PentaCB	pg/L	130	12.6	194	J,NBC,VIL
CO3-EF-04172018-01	Total TetraCB	pg/L		25.2	194	NBC,VIL
CO3-EF-04172018-01	Total TriCB	pg/L		42.9	48	NBC,VIL
CO4-EF-04172018-01	PCB 008	pg/L	27.9	2.36	48	J,NBC,VIL,VJ
CO4-EF-04172018-01	PCB 018/30	pg/L	35.8	5.41	48	J,NBC
CO4-EF-04172018-01	PCB 020/28	pg/L	34.3	7.76	48	J,NBC
CO4-EF-04172018-01	PCB 021/33	pg/L	19.5	7.96	48	J,NBC
CO4-EF-04172018-01	PCB 031	pg/L	27.9	7.29	48	J,NBC
CO4-EF-04172018-01	PCB 044/47/65	pg/L	37.8	8.16	97	J,NBC,VIU
CO4-EF-04172018-01	PCB 049/69	pg/L	16.9	7.72	97	J,NBC,VIU
CO4-EF-04172018-01	PCB 052	pg/L	33.8	7.96	48	J,JA,NBC,VIL,VIU
CO4-EF-04172018-01	PCB 056	pg/L	12.1	6.33	48	J,NBC
CO4-EF-04172018-01	PCB 060	pg/L		6.02	48	NBC

Appendix G: Water Quality Data

Sample ID	Analyte Name	Unit Name	Result	MDL	RL	QA Code
CO4-EF-04172018-01	PCB 066	pg/L	19.7	6.86	48	J,NBC,VIU
CO4-EF-04172018-01	PCB 070/61/74/76	pg/L	43.3	7.19	193	J,NBC,VIL,VIU,VJ
CO4-EF-04172018-01	PCB 083/99	pg/L	17.8	2.99	97	J,JA,NBC,VIL,VJ,VIU
CO4-EF-04172018-01	PCB 086/87/97/109/119/125	pg/L	31.6	2.61	193	J,NBC,VIL,VIU
CO4-EF-04172018-01	PCB 090/101/113	pg/L	38.5	2.59	193	J,NBC,VIL,VIU
CO4-EF-04172018-01	PCB 093/95/100	pg/L	29.1	4.92	193	J,NBC,VIL,VIU
CO4-EF-04172018-01	PCB 105	pg/L	16	4.73	19	J,NBC,VIU
CO4-EF-04172018-01	PCB 110/115	pg/L	49.7	2.37	97	J,NBC
CO4-EF-04172018-01	PCB 118	pg/L	29.7	4.35	19	NBC,VIL
CO4-EF-04172018-01	PCB 128/166	pg/L	6.79	3.24	97	J,JA,NBC,VIL,VJ,VIU
CO4-EF-04172018-01	PCB 129/138/163	pg/L	63.2	4.46	193	IP,J,NBC,VIL,VJ,VIU
CO4-EF-04172018-01	PCB 132	pg/L	14	3.95	48	J,NBC,VIL,VIU
CO4-EF-04172018-01	PCB 135/151/154	pg/L	15.2	2.51	97	VRIU,J,NBC,VIL,VJ
CO4-EF-04172018-01	PCB 141	pg/L	8.6	3.4	48	VRIU,J,NBC,VIL,VJ
CO4-EF-04172018-01	PCB 147/149	pg/L	31.1	3.36	97	J,NBC,VIL,VJ,VIU
CO4-EF-04172018-01	PCB 153/168	pg/L	51.6	2.89	97	IP,J,NBC,VIL,VJ,VIU
CO4-EF-04172018-01	PCB 156/157	pg/L	7.15	6.26	39	J,NBC,VIU
CO4-EF-04172018-01	PCB 158	pg/L	4.99	2.49	48	VRIU,J,NBC,VIL,VJ
CO4-EF-04172018-01	PCB 170	pg/L	11.9	4.86	48	J,NBC,VIL,VJ,VIU
CO4-EF-04172018-01	PCB 174	pg/L	10.8	4.03	48	J,NBC,VIL,VJ,VIU
CO4-EF-04172018-01	PCB 177	pg/L	6.01	4.35	48	J,JA,NBC,VIL,VJ,VIU
CO4-EF-04172018-01	PCB 180/193	pg/L	33.1	3.82	97	J,NBC,VIL,VJ,VIU
CO4-EF-04172018-01	PCB 183/185	pg/L	12.6	4.17	97	J,NBC,VIL,VJ,VIU
CO4-EF-04172018-01	PCB 187	pg/L	23.7	3.17	48	J,NBC,VIL,VJ,VIU
CO4-EF-04172018-01	PCB 194	pg/L	10.6	3.59	48	VRIP,IP,J,NBC,VIL,VJ
CO4-EF-04172018-01	PCB 195	pg/L		3.77	48	NBC,VIL,VJ,VIU
CO4-EF-04172018-01	PCB 201	pg/L		2.42	48	VRIU,NBC,VIL,VJ
CO4-EF-04172018-01	PCB 203	pg/L	6.36	3.42	48	J,JA,NBC,VIL,VJ,VIU
CO4-EF-04172018-01	Total DiCB	pg/L	27.9	2.36	19	NBC,VIL,VJ
CO4-EF-04172018-01	Total HeptaCB	pg/L	85.6	3.17	19	NBC,VIL,VJ
CO4-EF-04172018-01	Total HexaCB	pg/L	203	2.49	19	VIP,NBC,VIL,VJ
CO4-EF-04172018-01	Total MonoCB	pg/L		19.3	19	NBC
CO4-EF-04172018-01	Total NonaCB	pg/L		19.3	19	NBC
CO4-EF-04172018-01	Total OctaCB	pg/L	16.9	2.42	19	VRIP,J,NBC,VIL,VJ
CO4-EF-04172018-01	Total PCBs	pg/L	839	2.36	193	VIP,NBC,VIL,VJ
CO4-EF-04172018-01	Total PentaCB	pg/L	212	2.37	193	NBC,VIL
CO4-EF-04172018-01	Total TetraCB	pg/L	164	6.02	193	J,NBC,VIL
CO4-EF-04172018-01	Total TriCB	pg/L	117	5.41	48	NBC,VIL
CO5-EF-04172018-01	PCB 008	pg/L	19.6	1.35	49	J,NBC,VIL,VJ
CO5-EF-04172018-01	PCB 018/30	pg/L	27.1	2.91	49	J,NBC
CO5-EF-04172018-01	PCB 020/28	pg/L	33.9	3.59	49	J,NBC
CO5-EF-04172018-01	PCB 021/33	pg/L	16	3.69	49	J,JA,NBC
CO5-EF-04172018-01	PCB 031	pg/L	24.3	3.38	49	J,NBC
CO5-EF-04172018-01	PCB 044/47/65	pg/L	30.5	5.41	98	J,NBC,VIU
CO5-EF-04172018-01	PCB 049/69	pg/L	14.2	5.12	98	J,NBC,VIU
CO5-EF-04172018-01	PCB 052	pg/L	29.9	5.28	49	J,NBC,VIL,VIU

Appendix G: Water Quality Data

Sample ID	Analyte Name	Unit Name	Result	MDL	RL	QA Code
CO5-EF-04172018-01	PCB 056	pg/L	8.04	5	49	J,NBC
CO5-EF-04172018-01	PCB 060	pg/L		4.76	49	NBC
CO5-EF-04172018-01	PCB 066	pg/L	15.1	4.55	49	J,NBC,VIU
CO5-EF-04172018-01	PCB 070/61/74/76	pg/L	33.1	4.76	197	J,NBC,VIL,VIU,VJ
CO5-EF-04172018-01	PCB 083/99	pg/L	13.6	2.87	98	J,NBC,VIL,VJ,VIU
CO5-EF-04172018-01	PCB 086/87/97/109/119/125	pg/L	23.9	2.51	197	J,NBC,VIL,VIU
CO5-EF-04172018-01	PCB 090/101/113	pg/L	28.1	2.49	197	J,NBC,VIL,VIU
CO5-EF-04172018-01	PCB 093/95/100	pg/L	19.9	2.66	197	J,NBC,VIL,VIU
CO5-EF-04172018-01	PCB 105	pg/L	11.6	4.63	20	J,NBC,VIU
CO5-EF-04172018-01	PCB 110/115	pg/L	30.8	2.28	98	J,NBC
CO5-EF-04172018-01	PCB 118	pg/L	20.6	4.24	20	JA,NBC,VIL
CO5-EF-04172018-01	PCB 128/166	pg/L	5.1	2.12	98	J,NBC,VIL,VJ,VIU
CO5-EF-04172018-01	PCB 129/138/163	pg/L	38.2	2.92	197	IP,J,NBC,VIL,VJ,VIU
CO5-EF-04172018-01	PCB 132	pg/L	8.85	2.58	49	J,JA,NBC,VIL,VIU
CO5-EF-04172018-01	PCB 135/151/154	pg/L	7.19	1.59	98	VRIU,J,NBC,VIL,VJ
CO5-EF-04172018-01	PCB 141	pg/L	4.64	2.23	49	VRIU,J,NBC,VIL,VJ
CO5-EF-04172018-01	PCB 147/149	pg/L	20	2.2	98	J,NBC,VIL,VJ,VIU
CO5-EF-04172018-01	PCB 153/168	pg/L	24.8	1.89	98	VRIP,IP,J,NBC,VIL,VJ,VIU
CO5-EF-04172018-01	PCB 156/157	pg/L	4.32	3.83	39	J,NBC,VIU
CO5-EF-04172018-01	PCB 158	pg/L	2.76	1.63	49	VRIU,J,JA,NBC,VIL,VJ
CO5-EF-04172018-01	PCB 170	pg/L	6.83	2.82	49	J,JA,NBC,VIL,VJ,VIU
CO5-EF-04172018-01	PCB 174	pg/L	7.9	2.34	49	J,NBC,VIL,VJ,VIU
CO5-EF-04172018-01	PCB 177	pg/L	4.04	2.52	49	J,NBC,VIL,VJ,VIU
CO5-EF-04172018-01	PCB 180/193	pg/L	20.6	2.22	98	J,NBC,VIL,VJ,VIU
CO5-EF-04172018-01	PCB 183/185	pg/L	7.29	2.42	98	J,NBC,VIL,VJ,VIU
CO5-EF-04172018-01	PCB 187	pg/L	12	1.63	49	J,NBC,VIL,VJ,VIU
CO5-EF-04172018-01	PCB 194	pg/L	6.34	2.15	49	VRIP,IP,J,NBC,VIL,VJ
CO5-EF-04172018-01	PCB 195	pg/L		2.25	49	NBC,VIL,VJ,VIU
CO5-EF-04172018-01	PCB 201	pg/L		1.45	49	VRIU,NBC,VIL,VJ
CO5-EF-04172018-01	PCB 203	pg/L	5.01	2.05	49	J,NBC,VIL,VJ,VIU
CO5-EF-04172018-01	Total DiCB	pg/L	19.6	1.35	20	J,NBC,VIL,VJ
CO5-EF-04172018-01	Total HeptaCB	pg/L	51.4	1.63	20	NBC,VIL,VJ
CO5-EF-04172018-01	Total HexaCB	pg/L	116	1.59	20	VIP,NBC,VIL,VJ
CO5-EF-04172018-01	Total MonoCB	pg/L		19.7	20	NBC
CO5-EF-04172018-01	Total NonaCB	pg/L		19.7	20	NBC
CO5-EF-04172018-01	Total OctaCB	pg/L	11.3	1.45	20	VRIP,J,NBC,VIL,VJ
CO5-EF-04172018-01	Total PCBs	pg/L	586	1.35	197	VIP,NBC,VIL,VJ
CO5-EF-04172018-01	Total PentaCB	pg/L	149	2.28	197	J,NBC,VIL
CO5-EF-04172018-01	Total TetraCB	pg/L	131	4.55	197	J,NBC,VIL
CO5-EF-04172018-01	Total TriCB	pg/L	101	2.91	49	NBC,VIL
CO6-EF-04172018-01	PCB 008	pg/L	43.7	3.44	48	J,NBC,VIL,VJ
CO6-EF-04172018-01	PCB 018/30	pg/L	49.8	7.74	48	NBC
CO6-EF-04172018-01	PCB 020/28	pg/L	48.2	11.1	48	NBC
CO6-EF-04172018-01	PCB 021/33	pg/L	27.8	11.4	48	J,NBC
CO6-EF-04172018-01	PCB 031	pg/L	37.8	10.5	48	J,NBC
CO6-EF-04172018-01	PCB 044/47/65	pg/L	47.9	13.9	96	J,NBC,VIU

Appendix G: Water Quality Data

Sample ID	Analyte Name	Unit Name	Result	MDL	RL	QA Code
CO6-EF-04172018-01	PCB 049/69	pg/L	20.2	13.2	96	J,JA,NBC,VIU
CO6-EF-04172018-01	PCB 052	pg/L	49.5	13.6	48	NBC,VIL,VIU
CO6-EF-04172018-01	PCB 056	pg/L	14.5	11.4	48	J,NBC
CO6-EF-04172018-01	PCB 060	pg/L		10.9	48	NBC
CO6-EF-04172018-01	PCB 066	pg/L	23.7	11.7	48	J,NBC,VIU
CO6-EF-04172018-01	PCB 070/61/74/76	pg/L	53.5	12.3	192	J,NBC,VIL,VIU,VJ
CO6-EF-04172018-01	PCB 083/99	pg/L	23.4	6.28	96	J,JA,NBC,VIL,VJ,VIU
CO6-EF-04172018-01	PCB 086/87/97/109/119/125	pg/L	37.7	5.49	192	J,NBC,VIL,VIU
CO6-EF-04172018-01	PCB 090/101/113	pg/L	47.3	5.45	192	J,NBC,VIL,VIU
CO6-EF-04172018-01	PCB 093/95/100	pg/L	29.5	8.33	192	J,NBC,VIL,VIU
CO6-EF-04172018-01	PCB 105	pg/L	15	7.25	19	J,NBC,VIU
CO6-EF-04172018-01	PCB 110/115	pg/L	53.5	4.98	96	J,NBC
CO6-EF-04172018-01	PCB 118	pg/L	35	6.82	19	NBC,VIL
CO6-EF-04172018-01	PCB 128/166	pg/L	8.2	3.23	96	J,JA,NBC,VIL,VJ,VIU
CO6-EF-04172018-01	PCB 129/138/163	pg/L	71.8	4.45	192	IP,J,NBC,VIL,VJ,VIU
CO6-EF-04172018-01	PCB 132	pg/L	14	3.94	48	J,JA,NBC,VIL,VIU
CO6-EF-04172018-01	PCB 135/151/154	pg/L	16.5	3.43	96	VRIU,J,NBC,VIL,VJ
CO6-EF-04172018-01	PCB 141	pg/L	10.9	3.4	48	VRIU,J,NBC,VIL,VJ
CO6-EF-04172018-01	PCB 147/149	pg/L	34.4	3.36	96	J,NBC,VIL,VJ,VIU
CO6-EF-04172018-01	PCB 153/168	pg/L	44.2	2.88	96	IP,J,NBC,VIL,VJ,VIU
CO6-EF-04172018-01	PCB 156/157	pg/L		7.1	39	NBC,VIU
CO6-EF-04172018-01	PCB 158	pg/L	5.53	2.49	48	VRIU,J,NBC,VIL,VJ
CO6-EF-04172018-01	PCB 170	pg/L	10.7	7.54	48	J,NBC,VIL,VJ,VIU
CO6-EF-04172018-01	PCB 174	pg/L	11.6	6.25	48	J,NBC,VIL,VJ,VIU
CO6-EF-04172018-01	PCB 177	pg/L	6.75	6.75	48	J,JA,NBC,VIL,VJ,VIU
CO6-EF-04172018-01	PCB 180/193	pg/L	33.5	5.93	96	J,NBC,VIL,VJ,VIU
CO6-EF-04172018-01	PCB 183/185	pg/L	8.35	6.47	96	J,JA,NBC,VIL,VJ,VIU
CO6-EF-04172018-01	PCB 187	pg/L	17	3.17	48	J,NBC,VIL,VJ,VIU
CO6-EF-04172018-01	PCB 194	pg/L	8.43	5.44	48	VRIP,IP,J,JA,NBC,VIL,VJ
CO6-EF-04172018-01	PCB 195	pg/L		5.71	48	NBC,VIL,VJ,VIU
CO6-EF-04172018-01	PCB 201	pg/L		3.66	48	VRIU,NBC,VIL,VJ
CO6-EF-04172018-01	PCB 203	pg/L		5.18	48	NBC,VIL,VJ,VIU
CO6-EF-04172018-01	Total DiCB	pg/L	43.7	3.44	19	NBC,VIL,VJ
CO6-EF-04172018-01	Total HeptaCB	pg/L	79.6	3.17	19	NBC,VIL,VJ
CO6-EF-04172018-01	Total HexaCB	pg/L	206	2.49	19	VIP,NBC,VIL,VJ
CO6-EF-04172018-01	Total MonoCB	pg/L		19.2	19	NBC
CO6-EF-04172018-01	Total NonaCB	pg/L		19.2	19	NBC
CO6-EF-04172018-01	Total OctaCB	pg/L	8.43	3.66	19	VRIP,J,NBC,VIL,VJ
CO6-EF-04172018-01	Total PCBs	pg/L	960	2.49	192	VIP,NBC,VIL,VJ
CO6-EF-04172018-01	Total PentaCB	pg/L	241	4.98	192	NBC,VIL
CO6-EF-04172018-01	Total TetraCB	pg/L	209	10.9	192	NBC,VIL
CO6-EF-04172018-01	Total TriCB	pg/L	164	7.74	48	NBC,VIL
TW6-IN-04172018-01	PCB 008	pg/L	35.9	3.61	55	J,NBC,VIL,VJ
TW6-IN-04172018-01	PCB 018/30	pg/L	47	6.31	55	J,NBC
TW6-IN-04172018-01	PCB 020/28	pg/L	176	8.1	55	NBC
TW6-IN-04172018-01	PCB 021/33	pg/L	71	8.31	55	NBC

Appendix G: Water Quality Data

Sample ID	Analyte Name	Unit Name	Result	MDL	RL	QA Code
TW6-IN-04172018-01	PCB 031	pg/L	107	7.61	55	NBC
TW6-IN-04172018-01	PCB 044/47/65	pg/L	222	10.5	109	NBC,VIU
TW6-IN-04172018-01	PCB 049/69	pg/L	107	9.88	109	J,NBC,VIU
TW6-IN-04172018-01	PCB 052	pg/L	282	10.2	55	NBC,VIL,VIU
TW6-IN-04172018-01	PCB 056	pg/L	91	6.89	55	NBC
TW6-IN-04172018-01	PCB 060	pg/L	43.4	6.56	55	J,NBC
TW6-IN-04172018-01	PCB 066	pg/L	172	8.78	55	NBC,VIU
TW6-IN-04172018-01	PCB 070/61/74/76	pg/L	377	9.19	218	NBC,VIL,VIU,VJ
TW6-IN-04172018-01	PCB 083/99	pg/L	205	5.09	109	NBC,VIL,VJ,VIU
TW6-IN-04172018-01	PCB 086/87/97/109/119/125	pg/L	338	4.44	218	NBC,VIL,VIU
TW6-IN-04172018-01	PCB 090/101/113	pg/L	437	4.42	218	NBC,VIL,VIU
TW6-IN-04172018-01	PCB 093/95/100	pg/L	302	4.61	218	NBC,VIL,VIU
TW6-IN-04172018-01	PCB 105	pg/L	228	2.88	22	NBC,VIU
TW6-IN-04172018-01	PCB 110/115	pg/L	630	4.03	109	NBC
TW6-IN-04172018-01	PCB 118	pg/L	454	2.64	22	NBC,VIL
TW6-IN-04172018-01	PCB 128/166	pg/L	138	2.47	109	NBC,VIL,VJ,VIU
TW6-IN-04172018-01	PCB 129/138/163	pg/L	1180	3.41	218	VIP,NBC,VIL,VJ,VIU
TW6-IN-04172018-01	PCB 132	pg/L	256	3.01	55	NBC,VIL,VIU
TW6-IN-04172018-01	PCB 135/151/154	pg/L	193	2.25	109	VRIU,NBC,VIL,VJ
TW6-IN-04172018-01	PCB 141	pg/L	166	2.6	55	VRIU,NBC,VIL,VJ
TW6-IN-04172018-01	PCB 147/149	pg/L	512	2.57	109	NBC,VIL,VJ,VIU
TW6-IN-04172018-01	PCB 153/168	pg/L	664	2.21	109	VIP,NBC,VIL,VJ,VIU
TW6-IN-04172018-01	PCB 156/157	pg/L	109	6.21	44	NBC,VIU
TW6-IN-04172018-01	PCB 158	pg/L	87.7	1.9	55	VRIU,NBC,VIL,VJ
TW6-IN-04172018-01	PCB 170	pg/L	285	6.02	55	NBC,VIL,VJ,VIU
TW6-IN-04172018-01	PCB 174	pg/L	246	4.99	55	NBC,VIL,VJ,VIU
TW6-IN-04172018-01	PCB 177	pg/L	150	5.39	55	NBC,VIL,VJ,VIU
TW6-IN-04172018-01	PCB 180/193	pg/L	668	4.73	109	NBC,VIL,VJ,VIU
TW6-IN-04172018-01	PCB 183/185	pg/L	188	5.17	109	NBC,VIL,VJ,VIU
TW6-IN-04172018-01	PCB 187	pg/L	321	2.6	55	NBC,VIL,VJ,VIU
TW6-IN-04172018-01	PCB 194	pg/L	160	3.94	55	IP,NBC,VIL,VJ
TW6-IN-04172018-01	PCB 195	pg/L	55.9	4.15	55	NBC,VIL,VJ,VIU
TW6-IN-04172018-01	PCB 201	pg/L	22.9	2.66	55	VRIU,J,NBC,VIL,VJ
TW6-IN-04172018-01	PCB 203	pg/L	134	3.76	55	NBC,VIL,VJ,VIU
TW6-IN-04172018-01	Total DiCB	pg/L	35.9	3.61	22	NBC,VIL,VJ
TW6-IN-04172018-01	Total HeptaCB	pg/L	1670	2.6	22	NBC,VIL,VJ
TW6-IN-04172018-01	Total HexaCB	pg/L	3310	1.9	22	VIP,NBC,VIL,VJ
TW6-IN-04172018-01	Total MonoCB	pg/L		21.8	22	NBC
TW6-IN-04172018-01	Total NonaCB	pg/L		21.8	22	NBC
TW6-IN-04172018-01	Total OctaCB	pg/L	373	2.66	22	VIP,NBC,VIL,VJ
TW6-IN-04172018-01	Total PCBs	pg/L	9860	1.9	218	VIP,NBC,VIL,VJ
TW6-IN-04172018-01	Total PentaCB	pg/L	2590	2.64	218	NBC,VIL
TW6-IN-04172018-01	Total TetraCB	pg/L	1300	6.56	218	NBC,VIL
TW6-IN-04172018-01	Total TriCB	pg/L	401	6.31	55	NBC,VIL
CO4-EF-04192018-01	PCB 008	pg/L	37.8	1.74	48	J,NBC,VIL,VJ
CO4-EF-04192018-01	PCB 018/30	pg/L	38	4.44	48	J,NBC

Appendix G: Water Quality Data

Sample ID	Analyte Name	Unit Name	Result	MDL	RL	QA Code
CO4-EF-04192018-01	PCB 020/28	pg/L	36.1	8.56	48	J,NBC
CO4-EF-04192018-01	PCB 021/33	pg/L	24.1	8.53	48	J,JA,NBC
CO4-EF-04192018-01	PCB 031	pg/L	33.5	7.91	48	J,NBC
CO4-EF-04192018-01	PCB 044/47/65	pg/L	47.2	4.23	96	J,NBC,VIU
CO4-EF-04192018-01	PCB 049/69	pg/L	24.9	3.97	96	J,NBC,VIU
CO4-EF-04192018-01	PCB 052	pg/L	66.1	4.18	48	NBC,VIL,VIU
CO4-EF-04192018-01	PCB 056	pg/L		12.3	48	NBC
CO4-EF-04192018-01	PCB 060	pg/L		12.1	48	NBC
CO4-EF-04192018-01	PCB 066	pg/L	17.7	3.27	48	J,NBC,VIU
CO4-EF-04192018-01	PCB 070/61/74/76	pg/L	45.9	3.52	192	J,NBC,VIL,VIU,VJ
CO4-EF-04192018-01	PCB 083/99	pg/L	21.5	4.34	96	J,JA,NBC,VIL,VJ,VIU
CO4-EF-04192018-01	PCB 086/87/97/109/119/125	pg/L	30.2	3.8	192	J,JA,NBC,VIL,VIU
CO4-EF-04192018-01	PCB 090/101/113	pg/L	43	3.75	192	J,NBC,VIL,VIU
CO4-EF-04192018-01	PCB 093/95/100	pg/L	36.4	3.18	192	J,NBC,VIL,VIU
CO4-EF-04192018-01	PCB 105	pg/L	10	6.39	19	J,NBC,VIU
CO4-EF-04192018-01	PCB 110/115	pg/L	41.8	3.47	96	J,NBC
CO4-EF-04192018-01	PCB 118	pg/L	22.9	5.91	19	JA,NBC,VIL
CO4-EF-04192018-01	PCB 128/166	pg/L	6.91	4.6	96	J,NBC,VIL,VJ,VIU
CO4-EF-04192018-01	PCB 129/138/163	pg/L	47.5	5.99	192	J,NBC,VIL,VJ,VIU
CO4-EF-04192018-01	PCB 132	pg/L	11	5.47	48	J,NBC,VIL,VIU
CO4-EF-04192018-01	PCB 135/151/154	pg/L	15	2.55	96	VRIU,J,NBC,VIL,VJ
CO4-EF-04192018-01	PCB 141	pg/L	5.69	4.62	48	VRIU,J,JA,NBC,VIL,VJ
CO4-EF-04192018-01	PCB 147/149	pg/L	24.5	4.54	96	J,NBC,VIL,VJ,VIU
CO4-EF-04192018-01	PCB 153/168	pg/L	36	3.94	96	IP,J,NBC,VIL,VJ,VIU
CO4-EF-04192018-01	PCB 156/157	pg/L		6.32	38	NBC,VIU
CO4-EF-04192018-01	PCB 158	pg/L		3.46	48	VRIU,NBC,VIL,VJ
CO4-EF-04192018-01	PCB 170	pg/L		5.97	48	NBC,VIL,VJ,VIU
CO4-EF-04192018-01	PCB 174	pg/L	8.3	4.49	48	J,NBC,VIL,VJ,VIU
CO4-EF-04192018-01	PCB 177	pg/L		4.84	48	NBC,VIL,VJ,VIU
CO4-EF-04192018-01	PCB 180/193	pg/L	20.4	4.47	96	J,NBC,VIL,VJ,VIU
CO4-EF-04192018-01	PCB 183/185	pg/L	9.78	4.39	96	J,NBC,VIL,VJ,VIU
CO4-EF-04192018-01	PCB 187	pg/L	11.1	2.53	48	J,JA,NBC,VIL,VJ,VIU
CO4-EF-04192018-01	PCB 194	pg/L	8.43	5.4	48	J,NBC,VIL,VJ
CO4-EF-04192018-01	PCB 195	pg/L		4.61	48	NBC,VIL,VJ,VIU
CO4-EF-04192018-01	PCB 201	pg/L		2.31	48	VRIU,NBC,VIL,VJ
CO4-EF-04192018-01	PCB 203	pg/L		3.81	48	NBC,VIL,VJ,VIU
CO4-EF-04192018-01	Total DiCB	pg/L	37.8	1.74	19	NBC,VIL,VJ
CO4-EF-04192018-01	Total HeptaCB	pg/L	39.8	2.53	19	NBC,VIL,VJ
CO4-EF-04192018-01	Total HexaCB	pg/L	147	2.55	19	VIP,NBC,VIL,VJ
CO4-EF-04192018-01	Total MonoCB	pg/L		19.2	19	NBC
CO4-EF-04192018-01	Total NonaCB	pg/L		19.2	19	NBC
CO4-EF-04192018-01	Total OctaCB	pg/L	8.43	2.31	19	J,NBC,VIL,VJ
CO4-EF-04192018-01	Total PCBs	pg/L	782	1.74	192	VIP,NBC,VIL,VJ
CO4-EF-04192018-01	Total PentaCB	pg/L	206	3.18	192	NBC,VIL
CO4-EF-04192018-01	Total TetraCB	pg/L	202	3.27	192	NBC,VIL
CO4-EF-04192018-01	Total TriCB	pg/L	132	4.44	48	NBC,VIL

Appendix G: Water Quality Data

Sample ID	Analyte Name	Unit Name	Result	MDL	RL	QA Code
TW2-IN-04192018-01	PCB 008	pg/L	19.9	2.59	48	J,NBC,VIL,VJ
TW2-IN-04192018-01	PCB 018/30	pg/L	49.1	7.77	48	NBC
TW2-IN-04192018-01	PCB 020/28	pg/L	91.5	6.35	48	NBC
TW2-IN-04192018-01	PCB 021/33	pg/L	37.1	6.33	48	J,NBC
TW2-IN-04192018-01	PCB 031	pg/L	74.5	5.87	48	NBC
TW2-IN-04192018-01	PCB 044/47/65	pg/L	115	5.83	96	NBC,VIU
TW2-IN-04192018-01	PCB 049/69	pg/L	55.8	5.47	96	J,NBC,VIU
TW2-IN-04192018-01	PCB 052	pg/L	125	5.76	48	NBC,VIL,VIU
TW2-IN-04192018-01	PCB 056	pg/L	39.2	5.48	48	J,NBC
TW2-IN-04192018-01	PCB 060	pg/L	20.6	5.37	48	J,JA,NBC
TW2-IN-04192018-01	PCB 066	pg/L	63.3	4.51	48	NBC,VIU
TW2-IN-04192018-01	PCB 070/61/74/76	pg/L	136	4.85	192	J,NBC,VIL,VIU,VJ
TW2-IN-04192018-01	PCB 083/99	pg/L	50.3	5.21	96	J,NBC,VIL,VJ,VIU
TW2-IN-04192018-01	PCB 086/87/97/109/119/125	pg/L	67.6	4.56	192	J,NBC,VIL,VIU
TW2-IN-04192018-01	PCB 090/101/113	pg/L	74.4	4.51	192	J,NBC,VIL,VIU
TW2-IN-04192018-01	PCB 093/95/100	pg/L	58.4	5.1	192	J,NBC,VIL,VIU
TW2-IN-04192018-01	PCB 105	pg/L	35.6	4.34	19	NBC,VIU
TW2-IN-04192018-01	PCB 110/115	pg/L	105	4.16	96	NBC
TW2-IN-04192018-01	PCB 118	pg/L	66.3	4.03	19	NBC,VIL
TW2-IN-04192018-01	PCB 128/166	pg/L	17.8	4.24	96	J,NBC,VIL,VJ,VIU
TW2-IN-04192018-01	PCB 129/138/163	pg/L	150	5.53	192	J,NBC,VIL,VJ,VIU
TW2-IN-04192018-01	PCB 132	pg/L	29.4	5.05	48	J,NBC,VIL,VIU
TW2-IN-04192018-01	PCB 135/151/154	pg/L	34.3	3.07	96	VRIU,J,NBC,VIL,VJ
TW2-IN-04192018-01	PCB 141	pg/L	15.7	4.26	48	VRIU,J,JA,NBC,VIL,VJ
TW2-IN-04192018-01	PCB 147/149	pg/L	52.2	4.19	96	J,NBC,VIL,VJ,VIU
TW2-IN-04192018-01	PCB 153/168	pg/L	171	3.64	96	VIP,NBC,VIL,VJ,VIU
TW2-IN-04192018-01	PCB 156/157	pg/L	13.9	6.31	38	J,NBC,VIU
TW2-IN-04192018-01	PCB 158	pg/L	8.3	3.2	48	VRIU,J,JA,NBC,VIL,VJ
TW2-IN-04192018-01	PCB 170	pg/L	38	7.21	48	J,NBC,VIL,VJ,VIU
TW2-IN-04192018-01	PCB 174	pg/L	18.1	5.42	48	J,NBC,VIL,VJ,VIU
TW2-IN-04192018-01	PCB 177	pg/L	16.2	5.85	48	J,JA,NBC,VIL,VJ,VIU
TW2-IN-04192018-01	PCB 180/193	pg/L	88.8	5.4	96	J,NBC,VIL,VJ,VIU
TW2-IN-04192018-01	PCB 183/185	pg/L	24.5	5.3	96	J,JA,NBC,VIL,VJ,VIU
TW2-IN-04192018-01	PCB 187	pg/L	73.2	3.48	48	NBC,VIL,VJ,VIU
TW2-IN-04192018-01	PCB 194	pg/L	32.7	6.48	48	J,NBC,VIL,VJ
TW2-IN-04192018-01	PCB 195	pg/L	8.1	5.53	48	J,JA,NBC,VIL,VJ,VIU
TW2-IN-04192018-01	PCB 201	pg/L	3.5	2.78	48	VRIU,J,NBC,VIL,VJ
TW2-IN-04192018-01	PCB 203	pg/L	17.9	4.57	48	J,NBC,VIL,VJ,VIU
TW2-IN-04192018-01	Total DiCB	pg/L	19.9	2.59	19	NBC,VIL,VJ
TW2-IN-04192018-01	Total HeptaCB	pg/L	234	3.48	19	NBC,VIL,VJ
TW2-IN-04192018-01	Total HexaCB	pg/L	493	3.07	19	VIP,NBC,VIL,VJ
TW2-IN-04192018-01	Total MonoCB	pg/L		19.2	19	NBC
TW2-IN-04192018-01	Total NonaCB	pg/L		19.2	19	NBC
TW2-IN-04192018-01	Total OctaCB	pg/L	62.2	2.78	19	NBC,VIL,VJ
TW2-IN-04192018-01	Total PCBs	pg/L	2100	2.59	192	VIP,NBC,VIL,VJ
TW2-IN-04192018-01	Total PentaCB	pg/L	458	4.03	192	NBC,VIL

Appendix G: Water Quality Data

Sample ID	Analyte Name	Unit Name	Result	MDL	RL	QA Code
TW2-IN-04192018-01	Total TetraCB	pg/L	556	4.51	192	NBC,VIL
TW2-IN-04192018-01	Total TriCB	pg/L	252	5.87	48	NBC,VIL
CO1-EF-05092018-01	PCB 008	pg/L	31.9	7.11	48	J,NBC,VIL,VJ
CO1-EF-05092018-01	PCB 018/30	pg/L	18.9	9.26	48	J,NBC
CO1-EF-05092018-01	PCB 020/28	pg/L	23.1	10.9	48	J,JA,NBC
CO1-EF-05092018-01	PCB 021/33	pg/L	27.4	11.1	48	J,NBC
CO1-EF-05092018-01	PCB 031	pg/L		10.2	48	NBC
CO1-EF-05092018-01	PCB 044/47/65	pg/L	23.3	12.4	96	J,JA,NBC,VIU
CO1-EF-05092018-01	PCB 049/69	pg/L		11.7	96	NBC,VIU
CO1-EF-05092018-01	PCB 052	pg/L	21	12.1	48	J,NBC,VIL,VIU
CO1-EF-05092018-01	PCB 056	pg/L		19.4	48	NBC
CO1-EF-05092018-01	PCB 060	pg/L		19.4	48	NBC
CO1-EF-05092018-01	PCB 066	pg/L		10.5	48	NBC,VIU
CO1-EF-05092018-01	PCB 070/61/74/76	pg/L	105	43.6	191	J,NBC,VIL,VIU,VJ
CO1-EF-05092018-01	PCB 083/99	pg/L	13.3	6.37	96	J,JA,NBC,VIL,VJ,VIU
CO1-EF-05092018-01	PCB 086/87/97/109/119/125	pg/L	25.5	5.66	191	J,NBC,VIL,VIU
CO1-EF-05092018-01	PCB 090/101/113	pg/L	27.1	5.52	191	J,NBC,VIL,VIU
CO1-EF-05092018-01	PCB 093/95/100	pg/L	32.6	4.44	191	J,NBC,VIL,VIU
CO1-EF-05092018-01	PCB 105	pg/L		11.8	19	NBC,VIU
CO1-EF-05092018-01	PCB 110/115	pg/L	48.9	5.19	96	J,NBC
CO1-EF-05092018-01	PCB 118	pg/L	12.5	10.8	19	J,NBC,VIL
CO1-EF-05092018-01	PCB 128/166	pg/L	9.24	4.56	96	J,NBC,VIL,VJ,VIU
CO1-EF-05092018-01	PCB 129/138/163	pg/L	50	4.98	191	J,NBC,VIL,VJ,VIU
CO1-EF-05092018-01	PCB 132	pg/L	14.1	5.15	48	J,NBC,VIL,VIU
CO1-EF-05092018-01	PCB 135/151/154	pg/L	14.6	3.33	96	VRIU,J,NBC,VIL,VJ
CO1-EF-05092018-01	PCB 141	pg/L	7.76	4.62	48	VRIU,J,JA,NBC,VIL,VJ
CO1-EF-05092018-01	PCB 147/149	pg/L	26.6	4.19	96	J,NBC,VIL,VJ,VIU
CO1-EF-05092018-01	PCB 153/168	pg/L	32.7	3.92	96	J,NBC,VIL,VJ,VIU
CO1-EF-05092018-01	PCB 156/157	pg/L		7.24	38	NBC,VIU
CO1-EF-05092018-01	PCB 158	pg/L	7.17	3.45	48	VRIU,J,NBC,VIL,VJ
CO1-EF-05092018-01	PCB 170	pg/L	11.9	8.21	48	J,JA,NBC,VIL,VJ,VIU
CO1-EF-05092018-01	PCB 174	pg/L	13.3	6.26	48	J,JA,NBC,VIL,VJ,VIU
CO1-EF-05092018-01	PCB 177	pg/L		6.69	48	NBC,VIL,VJ,VIU
CO1-EF-05092018-01	PCB 180/193	pg/L	34.2	6.4	96	J,NBC,VIL,VJ,VIU
CO1-EF-05092018-01	PCB 183/185	pg/L	12.5	6.13	96	J,NBC,VIL,VJ,VIU
CO1-EF-05092018-01	PCB 187	pg/L	17.6	3.55	48	J,NBC,VIL,VJ,VIU
CO1-EF-05092018-01	PCB 194	pg/L		10.4	48	NBC,VIL,VJ
CO1-EF-05092018-01	PCB 195	pg/L		9.39	48	NBC,VIL,VJ,VIU
CO1-EF-05092018-01	PCB 201	pg/L		5.12	48	VRIU,NBC,VIL,VJ
CO1-EF-05092018-01	PCB 203	pg/L		8.14	48	NBC,VIL,VJ,VIU
CO1-EF-05092018-01	Total DiCB	pg/L	31.9	7.11	19	NBC,VIL,VJ
CO1-EF-05092018-01	Total HeptaCB	pg/L	77	3.55	19	NBC,VIL,VJ
CO1-EF-05092018-01	Total HexaCB	pg/L	162	3.33	19	NBC,VIL,VJ
CO1-EF-05092018-01	Total MonoCB	pg/L		19.1	19	NBC
CO1-EF-05092018-01	Total NonaCB	pg/L		19.1	19	NBC
CO1-EF-05092018-01	Total OctaCB	pg/L		5.12	19	NBC,VIL,VJ

Appendix G: Water Quality Data

Sample ID	Analyte Name	Unit Name	Result	MDL	RL	QA Code
CO1-EF-05092018-01	Total PCBs	pg/L	662	3.33	191	NBC,VIL,VJ
CO1-EF-05092018-01	Total PentaCB	pg/L	160	4.44	191	J,NBC,VIL
CO1-EF-05092018-01	Total TetraCB	pg/L	149	10.5	191	J,NBC,VIL
CO1-EF-05092018-01	Total TriCB	pg/L	69.5	9.26	48	NBC,VIL
TW2-IN-05092018-01	PCB 008	pg/L	37.8	2.15	48	J,NBC,VIL,VJ
TW2-IN-05092018-01	PCB 018/30	pg/L	29.2	4.43	48	J,NBC
TW2-IN-05092018-01	PCB 020/28	pg/L	93.6	4.35	48	NBC
TW2-IN-05092018-01	PCB 021/33	pg/L	44.8	4.45	48	J,NBC
TW2-IN-05092018-01	PCB 031	pg/L	62.1	4.08	48	NBC
TW2-IN-05092018-01	PCB 044/47/65	pg/L	123	5.66	96	NBC,VIU
TW2-IN-05092018-01	PCB 049/69	pg/L	52	5.33	96	J,NBC,VIU
TW2-IN-05092018-01	PCB 052	pg/L	247	5.5	48	NBC,VIL,VIU
TW2-IN-05092018-01	PCB 056	pg/L	26.9	10.1	48	J,JA,NBC
TW2-IN-05092018-01	PCB 060	pg/L	17.3	10.2	48	J,NBC
TW2-IN-05092018-01	PCB 066	pg/L	85.3	4.8	48	NBC,VIU
TW2-IN-05092018-01	PCB 070/61/74/76	pg/L	501	20	192	NBC,VIL,VIU,VJ
TW2-IN-05092018-01	PCB 083/99	pg/L	204	3.25	96	NBC,VIL,VJ,VIU
TW2-IN-05092018-01	PCB 086/87/97/109/119/125	pg/L	310	2.89	192	NBC,VIL,VIU
TW2-IN-05092018-01	PCB 090/101/113	pg/L	414	2.82	192	NBC,VIL,VIU
TW2-IN-05092018-01	PCB 093/95/100	pg/L	410	3.36	192	NBC,VIL,VIU
TW2-IN-05092018-01	PCB 105	pg/L	191	5.48	19	NBC,VIU
TW2-IN-05092018-01	PCB 110/115	pg/L	795	2.65	96	NBC
TW2-IN-05092018-01	PCB 118	pg/L	401	5.03	19	NBC,VIL
TW2-IN-05092018-01	PCB 128/166	pg/L	166	3.43	96	NBC,VIL,VJ,VIU
TW2-IN-05092018-01	PCB 129/138/163	pg/L	914	3.75	192	NBC,VIL,VJ,VIU
TW2-IN-05092018-01	PCB 132	pg/L	270	3.87	48	NBC,VIL,VIU
TW2-IN-05092018-01	PCB 135/151/154	pg/L	159	2.21	96	VRIU,NBC,VIL,VJ
TW2-IN-05092018-01	PCB 141	pg/L	132	3.47	48	VRIU,NBC,VIL,VJ
TW2-IN-05092018-01	PCB 147/149	pg/L	437	3.15	96	NBC,VIL,VJ,VIU
TW2-IN-05092018-01	PCB 153/168	pg/L	520	2.95	96	NBC,VIL,VJ,VIU
TW2-IN-05092018-01	PCB 156/157	pg/L	101	6.26	38	NBC,VIU
TW2-IN-05092018-01	PCB 158	pg/L	87.8	2.6	48	VRIU,NBC,VIL,VJ
TW2-IN-05092018-01	PCB 170	pg/L	178	5.62	48	NBC,VIL,VJ,VIU
TW2-IN-05092018-01	PCB 174	pg/L	142	4.28	48	NBC,VIL,VJ,VIU
TW2-IN-05092018-01	PCB 177	pg/L	84.6	4.58	48	NBC,VIL,VJ,VIU
TW2-IN-05092018-01	PCB 180/193	pg/L	372	4.38	96	NBC,VIL,VJ,VIU
TW2-IN-05092018-01	PCB 183/185	pg/L	107	4.19	96	NBC,VIL,VJ,VIU
TW2-IN-05092018-01	PCB 187	pg/L	185	2.73	48	NBC,VIL,VJ,VIU
TW2-IN-05092018-01	PCB 194	pg/L	110	8.51	48	NBC,VIL,VJ
TW2-IN-05092018-01	PCB 195	pg/L	35.9	7.71	48	J,NBC,VIL,VJ,VIU
TW2-IN-05092018-01	PCB 201	pg/L	18.1	4.2	48	VRIU,J,NBC,VIL,VJ
TW2-IN-05092018-01	PCB 203	pg/L	93.2	6.68	48	NBC,VIL,VJ,VIU
TW2-IN-05092018-01	Total DiCB	pg/L	37.8	2.15	19	NBC,VIL,VJ
TW2-IN-05092018-01	Total HeptaCB	pg/L	962	2.73	19	NBC,VIL,VJ
TW2-IN-05092018-01	Total HexaCB	pg/L	2790	2.21	19	NBC,VIL,VJ
TW2-IN-05092018-01	Total MonoCB	pg/L		19.2	19	NBC

Appendix G: Water Quality Data

Sample ID	Analyte Name	Unit Name	Result	MDL	RL	QA Code
TW2-IN-05092018-01	Total NonaCB	pg/L		19.2	19	NBC
TW2-IN-05092018-01	Total OctaCB	pg/L	257	4.2	19	NBC,VIL,VJ
TW2-IN-05092018-01	Total PCBs	pg/L	8160	2.15	192	NBC,VIL,VJ
TW2-IN-05092018-01	Total PentaCB	pg/L	2730	2.65	192	NBC,VIL
TW2-IN-05092018-01	Total TetraCB	pg/L	1050	4.8	192	NBC,VIL
TW2-IN-05092018-01	Total TriCB	pg/L	230	4.08	48	NBC,VIL
QA Codes	http://www.ceden.org/CEDEN_Checker/Checker/DisplayCEDENLookUp.php?List=QALookUp					

Appendix G: Water Quality Data

Sample ID	Analyte Name	Unit Name	Result	MDL	RL	QA Code
CO1-EF-04102018-01	Mercury	ng/L	24.4	0.06	0.5	VIP,NBC
CO1-EF-04102018-01	Suspended Sediment Concentration	mg/L	116	0.91	0.9	NBC
CO1-EF-04102018-01	Total Organic Carbon	mg/L	26.7	0.3	2	D,NBC
CO2-EF-04102018-01	Mercury	ng/L	16.3	0.06	0.5	VIP,NBC
CO2-EF-04102018-01	Suspended Sediment Concentration	mg/L	104	0.9	0.9	NBC
CO2-EF-04102018-01	Total Organic Carbon	mg/L	11	0.07	0.5	NBC
CO3-EF-04102018-01	Mercury	ng/L	6.77	0.06	0.5	VIP,NBC
CO3-EF-04102018-01	Suspended Sediment Concentration	mg/L	50.3	0.92	0.9	NBC
CO3-EF-04102018-01	Total Organic Carbon	mg/L	42	0.3	2	D,NBC
CO4-EF-04102018-01	Mercury	ng/L	15.2	0.06	0.5	VIP,NBC
CO4-EF-04102018-01	Suspended Sediment Concentration	mg/L	89.1	0.96	1	NBC
CO4-EF-04102018-01	Total Organic Carbon	mg/L	28.9	0.3	2	D,NBC
CO5-EF-04102018-01	Mercury	ng/L	7.57	0.06	0.5	VIP,NBC
CO5-EF-04102018-01	Suspended Sediment Concentration	mg/L	78	0.92	0.9	NBC
CO5-EF-04102018-01	Total Organic Carbon	mg/L	27.7	0.3	2	D,NBC
CO6-EF-04102018-01	Mercury	ng/L	14	0.06	0.5	VIP,NBC
CO6-EF-04102018-01	Suspended Sediment Concentration	mg/L	118	0.91	0.9	NBC
CO6-EF-04102018-01	Total Organic Carbon	mg/L	32.9	0.3	2	D,NBC
TW2-IN-04102018-01	Mercury	ng/L	9.99	0.06	0.5	VIP,NBC
TW2-IN-04102018-01	Suspended Sediment Concentration	mg/L	19.4	0.9	0.9	NBC
TW2-IN-04102018-01	Total Organic Carbon	mg/L	5.39	0.07	0.5	NBC
CO1-EF-04132018-01	Mercury	ng/L	9.68	0.06	0.5	VIP,NBC
CO1-EF-04132018-01	Suspended Sediment Concentration	mg/L	21.9	0.89	0.9	NBC
CO1-EF-04132018-01	Total Organic Carbon	mg/L	12.3	0.3	2	D,NBC
CO2-EF-04132018-01	Mercury	ng/L	8.58	0.06	0.5	VIP,NBC
CO2-EF-04132018-01	Suspended Sediment Concentration	mg/L	13.3	0.9	0.9	NBC
CO2-EF-04132018-01	Total Organic Carbon	mg/L	5.72	0.07	0.5	NBC
CO3-EF-04132018-01	Mercury	ng/L	5.69	0.06	0.5	VIP,NBC
CO3-EF-04132018-01	Suspended Sediment Concentration	mg/L	14.5	0.89	0.9	NBC
CO3-EF-04132018-01	Total Organic Carbon	mg/L	19.1	0.3	2	D,NBC
CO4-EF-04132018-01	Mercury	ng/L	11.2	0.06	0.5	VIP,NBC
CO4-EF-04132018-01	Suspended Sediment Concentration	mg/L	17	0.93	0.9	NBC
CO4-EF-04132018-01	Total Organic Carbon	mg/L	13.8	0.3	2	D,NBC
CO5-EF-04132018-01	Mercury	ng/L	4.53	0.06	0.5	VIP,NBC
CO5-EF-04132018-01	Suspended Sediment Concentration	mg/L	17.3	0.92	0.9	NBC
CO5-EF-04132018-01	Total Organic Carbon	mg/L	12.5	0.3	2	D,NBC
CO6-EF-04132018-01	Mercury	ng/L	13.1	0.06	0.5	VIP,NBC
CO6-EF-04132018-01	Suspended Sediment Concentration	mg/L	35	0.93	0.9	NBC
CO6-EF-04132018-01	Total Organic Carbon	mg/L	15.9	0.3	2	D,NBC
TW2-IN-04132018-01	Mercury	ng/L	10.2	0.06	0.5	VIP,NBC
TW2-IN-04132018-01	Suspended Sediment Concentration	mg/L	40.2	0.89	0.9	NBC
TW2-IN-04132018-01	Total Organic Carbon	mg/L	1.71	0.07	0.5	NBC
BLNK-EF-04172018-01	Mercury	ng/L	1.96	0.06	0.5	VIP,NBC
BLNK-EF-04172018-01	Suspended Sediment Concentration	mg/L	1.4	0.9	0.9	NBC
BLNK-EF-04172018-01	Total Organic Carbon	mg/L	0.19	0.07	0.5	J,NBC

Appendix G: Water Quality Data

Sample ID	Analyte Name	Unit Name	Result	MDL	RL	QA Code
CO1-EF-04172018-01	Mercury	ng/L	9.74	0.06	0.5	VIP,NBC
CO1-EF-04172018-01	Suspended Sediment Concentration	mg/L	12.5	0.93	0.9	NBC
CO1-EF-04172018-01	Total Organic Carbon	mg/L	12.1	0.07	0.5	NBC
CO2-EF-04172018-01	Mercury	ng/L	2.17	0.06	0.5	VIP,NBC
CO2-EF-04172018-01	Suspended Sediment Concentration	mg/L	8.4	0.91	0.9	NBC
CO2-EF-04172018-01	Total Organic Carbon	mg/L	5.12	0.07	0.5	NBC
CO2-EF-04172018-D	Suspended Sediment Concentration	mg/L	9.1	0.92	0.9	NBC
CO2-EF-04172018-D	Total Organic Carbon	mg/L	5.15	0.07	0.5	NBC
CO3-EF-04172018-01	Mercury	ng/L	6.02	0.06	0.5	VIP,NBC
CO3-EF-04172018-01	Suspended Sediment Concentration	mg/L	19.3	0.96	1	NBC
CO3-EF-04172018-01	Total Organic Carbon	mg/L	21.6	0.3	2	D,NBC
CO4-EF-04172018-01	Mercury	ng/L	7.58	0.06	0.5	VIP,NBC
CO4-EF-04172018-01	Suspended Sediment Concentration	mg/L	16.5	0.94	0.9	NBC
CO4-EF-04172018-01	Total Organic Carbon	mg/L	14.4	0.3	2	D,NBC
CO5-EF-04172018-01	Mercury	ng/L	7.36	0.06	0.5	VIP,NBC
CO5-EF-04172018-01	Suspended Sediment Concentration	mg/L	11.7	0.92	0.9	NBC
CO5-EF-04172018-01	Total Organic Carbon	mg/L	12	0.3	2	D,NBC
CO6-EF-04172018-01	Mercury	ng/L	11.3	0.06	0.5	VIP,NBC
CO6-EF-04172018-01	Suspended Sediment Concentration	mg/L	26.7	0.95	1	NBC
CO6-EF-04172018-01	Total Organic Carbon	mg/L	17.2	0.3	2	D,NBC
TW6-IN-04172018-01	Mercury	ng/L	9.86	0.06	0.5	VIP,NBC
TW6-IN-04172018-01	Suspended Sediment Concentration	mg/L	16.3	0.89	0.9	NBC
TW6-IN-04172018-01	Total Organic Carbon	mg/L	1.64	0.07	0.5	NBC
CO4-EF-04192018-01	Mercury	ng/L	5.26	0.06	0.5	VIP,NBC
CO4-EF-04192018-01	Suspended Sediment Concentration	mg/L	9.7	0.9	0.9	NBC
CO6-EF-04192018-01	Mercury	ng/L	7.41	0.06	0.5	VIP,NBC
CO6-EF-04192018-01	Suspended Sediment Concentration	mg/L	11.1	0.94	0.9	NBC
CO6-EF-04192018-01	Total Organic Carbon	mg/L	10.9	0.3	2	D,NBC
TW2-IN-04192018-01	Mercury	ng/L	3	0.06	0.5	VIP,NBC
TW2-IN-04192018-01	Suspended Sediment Concentration	mg/L	1.9	0.89	0.9	NBC
QA Codes	http://www.ceden.org/CEDEN_Checker/Checker/DisplayCEDENLookUp.php?List=QALookUp					

Pollutants of Concern Monitoring for Management Action Effectiveness

Evaluation of Mercury and PCBs Removal Effectiveness of Full Trash Capture Hydrodynamic Separator Units

Project Report



Prepared for:

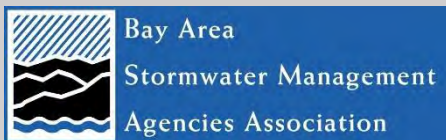

Prepared by:

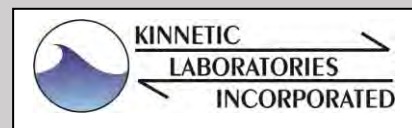

FINAL

February 20, 2019

DISCLAIMER

Information contained in BASMAA products is to be considered general guidance and is not to be construed as specific recommendations for specific cases. BASMAA is not responsible for the use of any such information for a specific case or for any damages, costs, liabilities or claims resulting from such use. Users of BASMAA products assume all liability directly or indirectly arising from use of the products.

The mention of commercial products, their source, or their use in connection with information in BASMAA products is not to be construed as an actual or implied approval, endorsement, recommendation, or warranty of such product or its use in connection with the information provided by BASMAA.

This disclaimer is applicable to all BASMAA products, whether information from the BASMAA products is obtained in hard copy form, electronically, or downloaded from the Internet

TABLE OF CONTENTS

LIST OF FIGURES.....	iv
LIST OF TABLES.....	iv
LIST OF ACRONYMS.....	v
EXECUTIVE SUMMARY	1
1 INTRODUCTION.....	5
1.1 Background	5
1.2 Problem Statement.....	6
1.3 Project Goal.....	7
2 METHODS.....	9
2.1 Overall Project Approach.....	9
2.2 HDS Unit Sampling	9
2.3 Laboratory Methods	10
2.4 Data Analysis and Reporting.....	11
2.4.1 Annual Mass of POCs Reduced Due to Cleanouts	11
2.4.2 Annual POC Stormwater loads discharged from each HDS Unit Catchment.....	13
2.4.3 Evaluation of HDS Unit Performance	16
3 RESULTS AND DISCUSSION.....	17
3.1 HDS Unit Sampling	17
3.1.1 Laboratory Analysis.....	23
3.2 Evaluation of HDS Unit Performance.....	26
3.2.1 HDS Unit Construction Details and Maintenance Records	26
3.2.2 Mass of POCs Removed During Cleanouts.....	29
3.2.3 HDS Catchment POC Loads and Calculated Percent Removals Due to Cleanouts.....	30
3.2.4 Limitations.....	32
4 CONCLUSIONS.....	33
5 REFERENCES.....	35
Appendix A: Final Study Design.....	36
Appendix B: Sampling and Analysis Plan and Quality Assurance Project Plan	37
Appendix C: QA Summary Reports	38
Appendix D: PCBs Congeners Concentration Data	39

LIST OF FIGURES

Figure 1.1	Basic features of a Contech Continuous Deflective Separator (CDS) Hydrodynamic Separator (HDS) Unit. Source: Contech Engineered Solutions 2014.	6
Figure 3.1	Catchment Sizes and Land Use Distributions for Existing Public HDS Units in the San Francisco Bay Area. The HDS units that were sampled in this study are identified with a black star (sediment-only samples collected) or diamond (sediment/organic debris samples collected).	17
Figure 3.2	Overview Map of the 8 HDS Units Sampled in the San Francisco Bay Area as Part of the BASMAA BMP Effectiveness Study.	18
Figure 3.3	Map of HDS Units #1 and #2 Catchments in Sunnyvale, CA.	20
Figure 3.4	Map of HDS Units #3 and #4 Catchments in Oakland, CA	20
Figure 3.5	Map of HDS Unit #5 Catchment in Palo Alto, CA	21
Figure 3.6	Map of HDS Unit #6 Catchment in San Jose, CA	21
Figure 3.7	Map of HDS Unit #7 Catchment in Sunnyvale, CA	22
Figure 3.8	Map of HDS Unit #8 Catchment in San Jose, CA	22

LIST OF TABLES

Table 2.1.	Laboratory Analytical Methods for Analytes in Sediment and Sediment/Organic Leaf debris.....	11
Table 2.2	Land Use-Based PCBs and Mercury Yields.	14
Table 2.3	Event Mean Concentrations in Water for PCBs and Mercury by Land Use Classification from the Regional Watershed Spreadsheet Model ¹	15
Table 3.1	HDS Units that were sampled in the San Francisco Bay Area as part of the BASMAA POC Monitoring for Management Action Effectiveness Study.....	19
Table 3.2	Chemical Analysis Results of Solids Collected from HDS Unit Sumps. ¹	25
Table 3.3	Summary of Information on Storage Capacity, Cleanout Frequencies, and Volumes of Solids Removed from HDS Unit Sumps.	27
Table 3.4	PCBs and Mercury Mass Removed During HDS Unit Sump Cleanouts. ¹	29
Table 3.5	HDS Unit Percent Removal of PCBs for Catchment Loads Calculated using Method #1 (Land use-based Yields) and Method #2 (RWSM Runoff Volume x Concentration).....	30
Table 3.6	HDS unit Percent Removal of Mercury for Catchment Loads Calculated using Method #1 (BASMAA Land use-based Yields) and Method #2 (RWSM Runoff Volume x Concentration)..	31

LIST OF ACRONYMS

ACCWP	Alameda Countywide Clean Water Program
BASMAA	Bay Area Stormwater Management Agencies Association
CCCWP	Contra Costa Clean Water Program
EPA	Environmental Protection Agency
FSURMP	Fairfield-Suisun Urban Runoff Management Program
GC/MS	Gas Chromatography/Mass Spectroscopy
HDS	Hydrodynamic Separator
KLI	Kinnetic Laboratories, Inc.
LCS	Laboratory Control Sample
MDL	Method Detection Limit
MRL	Method Reporting Limits
MRP	Municipal Regional Stormwater NPDES Permit
MS	Matrix Spike
MS4	Municipal Separate Storm Sewer System
na	not applicable
nr	not reported
ND	Non-Detect
NPDES	National Pollutant Discharge Elimination System
PCBs	Polychlorinated Biphenyl
PMT	Project Management Team
POC	Pollutants of Concern
ppb	parts per billion
ppm	parts per million
QA/QC	Quality Assurance/Quality Control
QAPP	Quality Assurance Project Plan
RWSM	Regional Watershed Spreadsheet Model
ROW	Right-of-Way
SAP	Sampling and Analysis Plan
SCVURPPP	Santa Clara Valley Urban Runoff Pollution Prevention Program
SFEI	San Francisco Estuary Institute
SMCWPPP	San Mateo Countywide Water Pollution Prevention Program
SOP	Standard Operating Procedure
TMDL	Total Maximum Daily Loads
VSFCD	City of Vallejo and the Vallejo Sanitation and Flood Control District

EXECUTIVE SUMMARY

INTRODUCTION

The Municipal Regional Stormwater National Pollutant Discharge Elimination System (NPDES) Permit (MRP; Order No. R2-2015-0049) implements the municipal stormwater portion of the mercury and polychlorinated biphenyls (PCBs) Total Maximum Daily Loads (TMDLs) for the San Francisco Bay. Provisions C.11 and C.12 of the MRP require mercury and PCBs load reductions and the development of a Reasonable Assurance Analysis (RAA) demonstrating that control measures will be sufficient to attain the TMDL wasteload allocations within specified timeframes. In compliance with the MRP, Permittees have implemented a number of source control measures in recent years designed to reduce pollutants of concern (POCs) in urban stormwater and achieve the wasteload allocations described in the mercury and PCBs TMDLs. For all control measures, an Interim Accounting Methodology for TMDL Loads Reduced has been developed to determine POC load reductions achieved based on relative mercury and PCBs yields from different land use categories (BASMAA, 2017a). Provision C.8.f of the MRP further supports implementation of the mercury and PCBs TMDLs by requiring that Permittees conduct POC monitoring to address management action effectiveness, one of the five priority information needs identified in the MRP. Management action effectiveness monitoring is intended to provide support for planning future management actions or evaluating the effectiveness or impacts of existing management actions.

To achieve compliance with the above permit requirements, the Bay Area Stormwater Management Agencies Association (BASMAA¹) implemented a regional project on behalf of its member agencies. The goal of the ***BASMAA POC Monitoring for Management Action Effectiveness -Evaluation of Mercury and PCBs Removal Effectiveness of Full Trash Capture Hydrodynamic Separator (HDS) Units*** project (the Project) was to evaluate the mercury and PCBs removal effectiveness of HDS units associated with removal of solids captured within the sump. The information provided by this monitoring effort will be used to support ongoing efforts by MRP Permittees and the California Regional Water Quality Control Board, San Francisco Bay Region (Regional Water Board) to better quantify the pollutant load reductions achieved by existing and future HDS units installed in urban watersheds of the Bay Area. This project was conducted between March 2017 and December 2018 in the portion of the San Francisco Bay Area subject to the MRP. The project was implemented by a project team comprised of EOA Inc., the Office of Water Programs at Sacramento State University (OWP), Kinnetic Laboratories, Inc. (KLI), and the San Francisco Estuary Institute (SFEI). A BASMAA Project Management Team (PMT) consisting of

¹ BASMAA is a 501(c)(3) non-profit organization that coordinates and facilitates regional activities of municipal stormwater programs in the San Francisco Bay Area. BASMAA programs support implementation of the MRP (Order No. R2-2015-0049). BASMAA is comprised of all 76 identified MRP municipalities and special districts, the Alameda Countywide Clean Water Program (ACCWP), Contra Costa Clean Water Program (CCCWP), the Santa Clara Valley Urban Runoff Pollution Prevention Program (SCVURPPP), the San Mateo Countywide Water Pollution Prevention Program (SMCWPPP), the Fairfield-Suisun Urban Runoff Management Program (FSURMP), the City of Vallejo and the Vallejo Sanitation and Flood Control District (VSFCD).

representatives from BASMAA stormwater programs and municipalities provided oversight and guidance to the project team.

METHODS

The Project combined sampling and modeling efforts to evaluate the mercury and PCBs removal performance of HDS units as follows. First, samples of the solids captured and removed from eight different HDS unit sumps during cleanout were collected and analyzed for PCBs and mercury. Second, maintenance records and construction plans for these HDS units were reviewed to develop estimates of the average volume of solids removed per cleanout. This information was combined with the monitoring data to calculate the mass of POCs removed during cleanouts. Third, the annual mercury and PCBs loads discharged from each HDS unit catchment were estimated using two different load calculation methods. Method #1 used the land use-based POC yields described in the BASMAA Interim Accounting Methodology (BASMAA 2017a) to estimate catchment loads. Method #2 used the Regional Watershed Spreadsheet Model (RWSM, Wu et al. 2017) to estimate runoff volumes and stormwater concentrations and calculate catchment loads. Finally, HDS unit performance was evaluated for both catchment load estimates by calculating the average annual percent removal of POCs as a result of the removal of solids from the HDS unit sumps.

RESULTS

Samples were collected from HDS units located in the cities of Palo Alto, Oakland, San Jose and Sunnyvale. These HDS units were selected opportunistically, based on the units that were scheduled for cleanout during the project sampling period (fall 2017 – spring 2018). The types of solid samples that were collected depended on the solids that were found in each sump, and included 3 sediment-only samples, and 5 sediment and organic/leafy debris samples. All samples were analyzed for the RMP 40 PCB congeners², total mercury, total solids (TS), total organic carbon (TOC), and bulk density. The sediment-only samples were also analyzed for grain size and were sieved at 2 millimeters (mm) prior to analysis for PCBs and mercury. The sediment and organic/leaf debris samples were analyzed as whole samples (not sieved) and were also analyzed for total organic matter in order to calculate the inorganic fraction (i.e., the mineral fraction assumed to be associated with POCs). Total PCBs concentrations across the 8 samples ranged from 0.01 to 0.41 milligram/kilogram (mg/kg) dry weight (dw). Total mercury concentrations ranged from 0.005 to 0.31 mg/kg dw. Overall, the range of mercury and PCBs concentrations measured in the HDS unit solids in the present study were similar to the average concentrations found in storm drain sediments and street dirt across the Bay Area, as reported elsewhere (BASMAA 2017a).

Based on review of maintenance records for 38 cleanout events, as well as construction details for each unit which provided information on each unit's storage capacity, the estimated average solids removed per cleanout ranged from 2.4 cubic yards (CY) to 37 CY. These numbers indicate the HDS unit sumps were on average 97% full when a cleanout was conducted. The calculated annual mass of PCBs removed

² The 40 individual congeners routinely quantified by the Regional Monitoring Program (RMP) for Water Quality in San Francisco Bay include: PCBs 8, 18, 28, 31, 33, 44, 49, 52, 56, 60, 66, 70, 74, 87, 95, 97, 99, 101, 105, 110, 118, 128, 132, 138, 141, 149, 151, 153, 156, 158, 170, 174, 177, 180, 183, 187, 194, 195, 201, and 203

from each unit ranged from 2 mg/year up to 2,600 mg/yr, while the annual mass of mercury removed from each unit ranged from 9 mg/year up to 6,500 mg/year. Differences in catchment sizes do not explain the high degree of variability observed across the different units. When normalized to catchment size, the mass of POCs removed per acre treated for the HDS units in this study remained highly variable, ranging from 0.01 mg/acre to 29 mg/acre for PCBs, and 0.03 mg/acre to 50 mg/acre for mercury.

PCBs Removal Rates (Table ES-1): For catchment loads calculated using Method #1 (land use-based yields), the median percent PCBs removal across all 8 units ranged from 5% to 10%. For catchment loads calculated using Method #2 (RWSM runoff volume x concentration), the median percent PCBs removal ranged from 15% to 32%. Variability in removal rates was high between individual units, ranging from almost no removal to 100% removal of the estimated loads.

Table ES-1. HDS Unit Performance - Annual Percent Removal Calculated For Two Catchment Load Estimates.

HDS Unit ID	PCBs Removal				Mercury Removal			
	Method #1		Method #2		Method #1		Method #2	
	Low	High	Low	High	Low	High	Low	High
1	80%	100%	100%	100%	26%	40%	100%	100%
2	8%	18%	10%	22%	4%	6%	65%	98%
3	4%	9%	21%	45%	2%	3%	8%	12%
4	38%	83%	27%	59%	5%	7%	17%	26%
5	0.06%	0.13%	0.21%	0.46%	0.1%	0.2%	1.1%	1.6%
6	5%	11%	20%	43%	0.01%	0.02%	0.1%	0.2%
7	0.6%	1.4%	0.5%	1.1%	0.06%	0.09%	2%	3%
8	1.4%	3.1%	7%	16%	3%	4%	27%	41%
Median	5%	10%	15%	32%	3%	4%	13%	19%

Mercury Removal Rates (Table ES-1): Across all 8 units, the median percent removal for catchment loads calculated using Method #1 (land use-based yields) ranged from 3% to 4%. For all units under Method #1, the removal rates were lower for mercury than for PCBs. For catchment loads calculated using Method #2 (RWSM runoff volume x concentration) the median removal ranged from 13% to 19%. Similar to PCBs, removal rates for mercury in individual HDS units were highly variable.

CONCLUSIONS

For both PCBs and mercury, the data from this study indicate the percent removals achieved by HDS unit cleanouts are highly variable across units, and likely variable within the same unit over time. The conclusions on pollutant removal effectiveness of HDS unit sump cleanouts based on the results of this study are limited by the small number of HDS units that were sampled (n=8) and the limited, and often incomplete, maintenance records that were available at the time of this study. Nevertheless, the results of this study provide new information on the range of pollutant concentrations measured in HDS unit sump solids. Additional data would be needed to fully characterize the range of pollutant load reductions achieved by HDS units over longer periods of time and across varying urban environments.

The results from this study will be considered in the update of the Interim Accounting Methodology that is being conducted as part of the BASMAA regional project *Source Control Load Reduction Accounting for Reasonable Assurance Analysis*, and will include methods for estimating POC reductions associated with stormwater control measures, including HDS units.

Additional recommendations on options for potentially improving the pollutant removal effectiveness of HDS unit maintenance practices, as well as improving the estimates presented in this report include the following:

- Develop site-specific standard operating procedures (SOPs) for each HDS unit, including suggested cleanout frequency and cleanout methods to ensure efficient and consistent practices over time.
- To improve pollutant removal effectiveness, cleanouts should occur well before sumps reach capacity. Frequent inspections of HDS unit sumps may also provide the information needed to determine an appropriate cleanout frequency for each HDS unit.
- To improve estimates of the solids removal achieved per cleanout (and the associated pollutant removals achieved), provide consistent recording of the following information: cleanout dates, measured depth of solids and water in the sump prior to a cleanout, estimates of the volumes of solids and water removed from the sump during cleanout, and a description of the types of solids removed.

1 INTRODUCTION

1.1 BACKGROUND

Fish tissue monitoring in San Francisco Bay (Bay) has revealed bioaccumulation of polychlorinated biphenyls (PCBs) and mercury. The measured fish tissue concentrations are thought to pose a health risk to people consuming fish caught in the Bay. As a result of these findings, California has issued an interim advisory on the consumption of fish from the Bay. The advisory led to the Bay being designated as an impaired water body on the Clean Water Act "Section 303(d) list" due to PCBs and mercury. In response, the California Regional Water Quality Control Board, San Francisco Bay Region (Regional Water Board) adopted total maximum daily loads (TMDLs) to address these pollutants of concern (POCs) (SFBRWQCB 2012).

Provisions C.11 and C.12 of the Municipal Regional Stormwater National Pollutant Discharge Elimination System (NPDES) Permit (MRP; Order No. R2-2015-0049) implements the municipal stormwater portion of the Mercury and PCBs TMDLs for the San Francisco Bay Area. These provisions require mercury and PCBs load reductions and the development of a Reasonable Assurance Analysis (RAA) demonstrating that control measures will be sufficient to attain the TMDL wasteload allocations within specified timeframes. In compliance with the MRP, Permittees have implemented a number of source control measures in recent years designed to reduce POCs in urban stormwater and achieve the wasteload allocations described in the mercury and PCBs TMDLs. For all control measures, the Bay Area Stormwater Management Agencies Association (BASMAA³) developed an Interim Accounting Methodology to define POC load reductions achieved based on relative mercury and PCBs yields from different land use categories (BASMAA 2017a).

Provision C.8.f of the MRP further supports implementation of the mercury and PCBs TMDLs by requiring that Permittees conduct POC monitoring to address management action effectiveness, one of the five priority information needs identified in the MRP. Management action effectiveness monitoring is intended to provide support for planning future management actions or evaluating the effectiveness or impacts of existing management actions. Although individual Countywide monitoring programs can meet all MRP monitoring requirements on their own, some requirements are conducted more efficiently, and likely yield more valuable information, when coordinated and implemented on a regional basis.

³ BASMAA is a 501(c)(3) non-profit organization that coordinates and facilitates regional activities of municipal stormwater programs in the San Francisco Bay Area. BASMAA programs support implementation of the MRP (Order No. R2-2015-0049). BASMAA is comprised of all 76 identified MRP municipalities and special districts, the Alameda Countywide Clean Water Program (ACCWP), Contra Costa Clean Water Program (CCCWP), the Santa Clara Valley Urban Runoff Pollution Prevention Program (SCVURPPP), the San Mateo Countywide Water Pollution Prevention Program (SMCWPPP), the Fairfield-Suisun Urban Runoff Management Program (FSURMP), the City of Vallejo and the Vallejo Sanitation and Flood Control District (VSFCD).

1.2 PROBLEM STATEMENT

During the previous MRP permit term (2009 – 2015), BASMAA pilot tested a number of different stormwater control measures for pollutant removal effectiveness through the Clean Watersheds for a Clean Bay (CW4CB) project (BASMAA 2017b). One treatment option that was pilot-tested during CW4CB includes hydrodynamic separator (HDS) units. HDS units have been installed for trash control throughout the Bay Area. An HDS unit typically consists of a circular concrete manhole structure that is installed underground, either inline or offline within the existing storm drainage system. As an example, the features of an inline Contech Continuous Deflective Separator (CDS) Unit are shown in Figure 1.1. Stormwater flows from the HDS catchment (up to the treatment design capacity) enter the device tangentially, which initiates a swirling motion to the water. This is enhanced by a curved deflection plate. The flows are then guided into the separation chamber, where swirl concentration and screen deflection force solids to the center of the chamber. The flow continues through the separation screen, under the oil baffle and exits the unit. All of the solids and debris larger than the screen apertures are trapped within the unit. Floatables (i.e., buoyant solids) will typically remain suspended in the water that is retained within the unit near the top of the treatment screen, while the heavier solids settle into the storage sump located directly below the screening area. These units are designed to collect trash, sediment and other solid debris. POC removal is expected to occur through capture of POC-containing solids in the HDS unit sumps, and subsequent removal and disposal of these solids during cleanouts. Generally, the net solids removal is expected to vary by site-specific conditions, and the removal efficiency for solids smaller than the screen apertures varies depending on the model selected and the flow characteristics of the site.

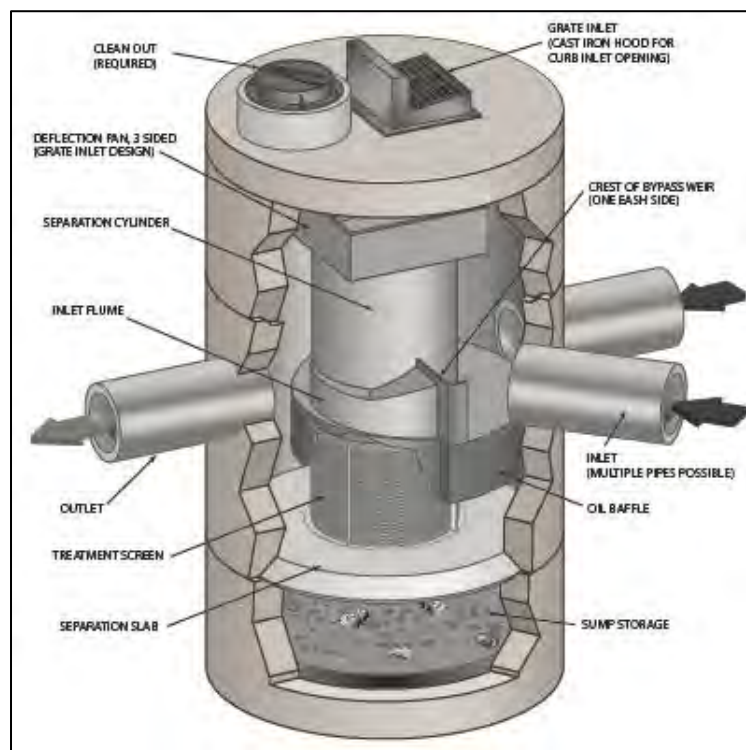

Figure 1.1 Basic features of a Contech Continuous Deflective Separator (CDS) Hydrodynamic Separator (HDS) Unit. Source: Contech Engineered Solutions 2014.

For HDS units and other stormwater control measures, BASMAA developed the ***Interim Accounting Methodology for TMDL Loads Reduced*** (Interim Accounting Methodology, BASMAA 2017a) to calculate load reductions achieved by these measures during the current permit term (2016 – 2020). The Interim Accounting Methodology is based on relative mercury and PCBs yields from different land use categories. For HDS units, the methodology assumes a default 20% reduction of the area-weighted land use-based pollutant yields for a given catchment. This default value was based on average percent removal of total suspended solids (TSS) from HDS units from an analysis of paired influent/effluent data reported in the International Stormwater Best Management Practices (BMP) Database (www.bmpdatabase.org), as described in Appendix C of the Interim Accounting Methodology (BASMAA 2017a). However, significant data gaps remain in determining the effectiveness of this practice and expected load reductions.

The CW4CB results suggested that the materials retained within the HDS unit sumps and removed during routine cleanouts provide reductions of POC mass that would otherwise remain in the municipal separate storm sewer system (MS4). However, the CW4CB pilot tests were limited to 2 data points, collected from a single HDS unit that drains a catchment with elevated mercury and PCBs concentrations. The monitoring performed to-date is not sufficient to characterize pollutant concentrations of solids captured in HDS units that drain catchments with different loading scenarios (e.g., land uses, stormwater volumes, source areas, etc.), nor to estimate the percent removal based on the pollutant load captured and removed from the HDS unit during ongoing maintenance practices.

1.3 PROJECT GOAL

The overall goal of this project is to evaluate the mercury and PCBs removal effectiveness of HDS units due to solids capture within the sumps and subsequent removal during cleanouts. The monitoring conducted through this project provides partial fulfilment of MRP monitoring requirements for management action effectiveness under provision C.8.f., while also addressing some of the data gaps identified by the CW4CB project (BASMAA 2017b). The information provided by this project will be used by MRP Permittees and the Regional Water Board to support ongoing efforts to better quantify the pollutant load reductions achieved by existing and future HDS units installed in urban watersheds of the Bay Area.

To accomplish the project goal, BASMAA implemented a regional project on behalf of its member agencies to collect samples of the solids removed from HDS Unit sumps during cleanout events to estimate the mass of POCs removed. This report presents the results of the ***BASMAA POC Monitoring for Management Action Effectiveness - Evaluation of Mercury and PCBs Removal Effectiveness of Full Trash Capture Hydrodynamic Separator Units*** project (the Project) that was conducted during 2017 and 2018 in the portion of the San Francisco Bay Area subject to the MRP. The project was implemented by a project team comprised of EOA Inc., the Office of Water Programs (OWP) at Sacramento State University, Kinetic Laboratories, Inc. (KLI), and the San Francisco Estuary Institute (SFEI). A BASMAA Project Management Team (PMT) consisting of representatives from BASMAA stormwater programs and municipalities provided oversight and guidance to the project team throughout the project.

Section 2 of this report presents the overall approach and details methods that were used to implement the project, including a description of the sampling and chemical analysis methods, and descriptions of

the methodology used to estimate the POC percent removals achieved through cleanouts. Section 3 presents the project results and discussion, including the location and description of each HDS unit that was sampled, a summary of the chemical analysis results for each unit, a summary of the cleanout events identified in maintenance records, the modeled estimates of the annual average POC stormwater loads within each HDS unit catchment, and the annual loads reduced (and percent removals achieved) through HDS unit maintenance practices. Section 4 summarizes the conclusions based on the results of the project.

2 METHODS

This section presents the overall approach and methods that were used to implement the Project. Under the guidance and oversight of the PMT, the project team developed a study design (Appendix A) and a SAP/QAPP (Appendix B), which were followed throughout implementation of the sampling program.

2.1 OVERALL PROJECT APPROACH

The overall approach to the Project involved a combined sampling and modeling effort to evaluate the mercury and PCBs removal performance of the sampled HDS units. The project implemented the following 4 tasks:

1. Collect samples of the solids captured in HDS unit sumps in Bay Area urban catchments and analyze them for mercury and PCBs;
2. Quantify the volume and mass of solids (and associated mercury and PCBs) removed from HDS unit sumps during cleanouts;
3. Estimate annual average mercury and PCBs stormwater loads for each HDS unit catchment of interest (i.e., the HDS unit catchments that were sampled in task 1);
4. Calculate the annual mercury and PCBs percent removals due to HDS unit cleanouts for each catchment of interest.

It is important to note this project was not designed to fully characterize the range of POC concentrations and masses captured in Bay Area HDS unit sumps. Nor was this project intended to provide highly accurate stormwater loading estimates for the catchments of interest. Rather, this project was intended to provide additional data to better quantify the mercury and PCBs load reduction effectiveness of HDS unit maintenance practices and support future development of source control RAAs.

The remainder of this section provides additional details on the methods and assumptions employed to implement the project tasks.

2.2 HDS UNIT SAMPLING

Across the Bay Area, at least 37 large, public HDS units have been installed in public right-of-way (ROW) locations over the past 10+ years. These units were primarily installed for trash controls. These units treat stormwater runoff from more than 13,000 acres spread across nine Bay Area municipalities. The size of the catchments treated by individual units in the Bay Area ranges from about 3 acres up to more than 900 acres. Selection of HDS units for sampling during this project was primarily opportunistic, based on the units that were scheduled for cleanouts during the project. The project team worked cooperatively with the PMT and multiple Bay Area municipal agencies to identify public HDS units that were scheduled for maintenance during the project sampling period (Fall 2017 through spring 2018). Additional selection criteria included cooperation of the appropriate municipal staff and safety considerations for the monitoring team. All field sampling was conducted during dry weather, when urban runoff flows through the HDS units were minimal and did not present safety hazards or other logistical concerns.

During sampling, HDS units were typically dewatered by municipal staff to remove standing water in the units and any floatables suspended in that water prior to sump cleanout. The monitoring team then collected multiple samples of the solids (sediment and organic debris) contained within each unit's sump, avoiding trash and other large debris. The solid samples were then combined and thoroughly homogenized in a stainless steel or Kynar-coated bucket, from which a composite sample was removed and aliquoted into separate jars for chemical analysis. Sample collection techniques varied between units due to the unique characteristics of each unit (i.e., sump depth and volume, safety considerations, etc.). For the majority of units, a stainless steel scoop on the end of a long pole was used to collect samples of the solids in the sump. However, in cases where the sump was too deep and/or too large to collect a representative sample using this method, samples were collected after the solids were removed from the sump by maintenance staff as the cleanout proceeded. Any confined space entry to remove solids from HDS unit sumps was performed by city maintenance staff trained and certified in such activities. One composite sample of the solids was collected for each HDS unit. The solid samples that were collected consisted of either sediment-only, or a combination of sediment and organic/leafy debris, depending on the type of solids that were found in each sump. The latter type of samples were collected in cases where this type of material dominated the solids content of the HDS unit sump, and collection of a sediment-only sample would not be representative of the solids in the sump.

2.3 LABORATORY METHODS

All solid samples were analyzed for the RMP 40 PCB congeners⁴, total mercury, total solids (TS), total organic carbon (TOC), and bulk density by the methods identified in Table 2.1. All sediment-only samples were also analyzed for grain size by the methods in Table 2.1. With the exception of grain size and bulk density, sediment-only samples were sieved by the laboratory at 2 mm prior to analysis. The sediment and organic/leaf debris samples were not sieved but were analyzed as whole samples. These samples were also analyzed for total organic matter (TOM) by the method identified in Table 2.1, in order to estimate the percent of the solid material that was organic (e.g., leaf debris) vs. inorganic (e.g., mineral content) because POCs in sump solids were assumed to be predominantly associated with the mineral fraction (i.e., the leafy material is expected to add few POCs but a large contribution to the total solids mass, and the relative proportion of organic-matter vs. mineral fractions provides assessment of the degree of dilution by organic matter).

Additional details about the field sampling and laboratory analysis methods are provided in the project SAP/QAPP (Appendix B).

⁴ The 40 individual congeners routinely quantified by the Regional Monitoring Program (RMP) for Water Quality in the San Francisco Estuary include: PCBs 8, 18, 28, 31, 33, 44, 49, 52, 56, 60, 66, 70, 74, 87, 95, 97, 99, 101, 105, 110, 118, 128, 132, 138, 141, 149, 151, 153, 156, 158, 170, 174, 177, 180, 183, 187, 194, 195, 201, and 203

Table 2.1. Laboratory Analytical Methods for Analytes in Sediment and Sediment/Organic Leaf debris.

Sample Type	Analyte	Sampling Method	Analytical Method	Reporting Units
All	Total Organic Carbon (TOC)	Grab	EPA 415.1, 440.0, 9060, or ASTM D4129M	%
Sediment-Only	Grain Size	Grab	ASTM D422M/PSEP	%
All	Bulk Density	Grab	ASTM E1109-86	g/cm ³
All	Mercury	Grab	EPA 7471A, 7473, or 1631	µg/kg
All	PCBs (RMP 40 Congeners)	Grab	EPA 1668	µg/kg
All	Total Solids	Grab	EPA160.3	%
Sediment + Organic/Leaf Debris	Total Organic Matter (TOM)	Grab	EPA160.4	%

2.4 DATA ANALYSIS AND REPORTING

The data collected during sampling was combined with estimated catchment loads to evaluate the POC removal performance of each HDS unit as follows. First, the annual mass of POCs reduced due to cleanouts was calculated from the measured POC concentrations in sump solids and the estimated average volume of solids removed per cleanout, and the total number of cleanouts per year. Next, the annual stormwater loads of POCs discharged from each HDS unit catchment were estimated using two different methods to calculate the catchment loads. Finally, HDS unit performance was evaluated by calculating the POC percent removals due to HDS Unit cleanouts for both catchment load estimates. Additional details about each of these steps are presented here.

2.4.1 Annual Mass of POCs Reduced Due to Cleanouts

The annual mass of POCs reduced due to removal of sump solids from HDS units during cleanouts was calculated using Equation 2-1.

$$(2-1) \quad M_{\text{HDS-}i} = V_{\text{HDS-}i} \times \rho_{\text{HDS-}i} \times F_{\text{POC-HDS-}i} \times C_{\text{POC, HDS-}i} \times N_{\text{HDS-}i}$$

Where:

- $M_{\text{HDS-}i}$ the total annual POC mass removed from the sump of HDS Unit i (mg/year);
- $V_{\text{HDS-}i}$ the volume of solids removed from HDS Unit i during a cleanout (cubic yards (CY) per cleanout);
- $\rho_{\text{HDS-}i}$ the bulk density of solids removed from HDS Unit i during a cleanout (kg/CY);
- $F_{\text{POC-HDS-}i}$ the mass fraction of solids removed from HDS Unit i during a cleanout that is associated with POCs;
- $C_{\text{POC, HDS-}i}$ the concentration of POCs in the solids removed from HDS Unit i during a cleanout (mg/kg dw);
- $N_{\text{HDS-}i}$ the number of cleanouts of HDS Unit i each year (cleanouts/year).

In order to provide the inputs required for Equation 2-1, additional information was gathered from the appropriate municipalities for each HDS unit that was sampled, including construction details (as-builts) and maintenance records on past cleanouts. Maintenance records were reviewed to gather information on the number and frequency of past cleanouts, and the volume of solids typically removed from sumps during cleanouts. Information on the types of materials removed during each cleanout was generally limited. However, any cleanout that only recorded removal of floatables (i.e., buoyant solids suspended in the water layer above the sump) was excluded from these evaluations, as the focus here was on removal of solid sediment and debris captured in the sumps. Although organic materials such as leaves are generally buoyant, these solids were frequently found in HDS unit sumps, likely because a sufficient mass of soil particles attached to the organic debris and caused the materials to settle in the sump. Additional assumptions described below were used to provide the inputs required for Equation 2-1.

- The average volume of solids removed from the sump per cleanout ($V_{\text{HDS-}i}$) was calculated for each unit from maintenance records or was assumed to be equivalent to the volume of the unit's solids storage sump if maintenance records were not available. Where available, maintenance records were reviewed to identify the volume of solids removed from a given unit's sump during each cleanout, and an average volume per cleanout calculated for each unit. Where not available, construction details (i.e., as-built drawings) were reviewed to calculate the sump storage capacity for each unit. The full sump capacity was selected as a reasonable estimate of the volume of solids removed during a cleanout because (1) the recorded volumes removed during cleanouts were typically near or even exceeded sump capacity; and (2) information provided by municipal staff indicated solids in the sumps were typically not removed unless the sumps were well over 50% full. This later information was further corroborated by maintenance records that identified a number of cleanouts were performed where only floatables were removed from the top layer of water in the unit's screening area, and no solids were removed from the sumps. As stated previously, cleanouts that only removed these floatables were not included in the calculation of the average volume of solids removed per cleanout. Initial attempts to further refine and/or improve the estimates of the average volumes of solids removed per cleanout based on maintenance records were evaluated, including (for example) normalizing the volume of solids removed in a given cleanout to the rainfall amounts within that catchment since the previous cleanout. However, because the maintenance data were limited, highly uncertain, and in many cases, incomplete, the outcomes of these efforts were inconclusive at best, and they were not pursued further.
- The fraction of solids removed during cleanouts that was associated with POCs ($F_{\text{POC-HDS-}i}$) was estimated from measurement data for each HDS unit. For sediment-only samples, the fraction associated with POCs was assumed to be the dry fraction of solids removed that was < 2 mm in grain size, where %TS accounts for the moisture content of the solids, and the % < 2 mm accounts for the small particle size fraction of the solids. For the sediment + organic/leaf samples, the fraction associated with POCs was assumed to be the dry fraction of solids removed that was inorganic, where % TOM measurement allows for calculation of the % inorganic (i.e., mineral content of the sample). These assumptions are consistent with catchment loads calculated in Section 2.4.2 for each HDS unit catchment. Catchment loads

calculated using the BASMAA land use-based POC yields (BASMAA 2017a) or using the Regional Watershed Spreadsheet Model (RWSM, Wu et al. 2017), both rely on inputs that assume POCs are associated with the smaller (i.e., < 2 mm) particle size fractions in stormwater.

- All of the measurement data used as inputs to Equation 2-1 (POC concentrations, bulk density, etc.) were assumed to be representative of the values of these parameters for typical sump solids removed during cleanouts over time for a given HDS Unit. This assumption was necessary because the data needed to evaluate the temporal and spatial variability in these parameters are currently unavailable. Multiple samples from the same HDS unit over a number of years would be needed to quantify the variability over time, while this project provided only 1 sample per unit. To account for some degree of variability in the measured POC concentrations, the average relative percent differences (RPDs) between field duplicate sediment samples collected from storm drain structures over the past 5+ years across the Bay Area were used (SCVURPPP 2018, SMCWPPP 2018, BASMAA 2017b). The RPD was calculated for 27 field duplicate pairs, and for PCBs, ranged from <1% to 185%, with an average of 37%. For mercury, the RPDs ranged from 4% to 43%, with an average of 17%. The average RPDs for PCBs and mercury were applied to the concentrations measured in this study to develop a low and high concentration estimate (and associated low and high POC mass removed per cleanout) for each unit.
- Two cleanouts per year were assumed. Although maintenance records provided some information on cleanout frequencies, it appears from both the information provided, and further discussion with municipal staff that cleanout frequency is highly variable from unit to unit and from year to year. A default assumption of two cleanouts per year was selected as a reasonable approximation based on the typical cleanout frequencies reported by maintenance staff.

2.4.2 Annual POC Stormwater loads discharged from each HDS Unit Catchment

For each HDS Unit, the annual average POC loads discharged from its catchment were calculated using two different methods. Method #1 is based on catchment-specific land use multiplied by land use-based POC yields described in the BASMAA Interim Accounting Methodology (BASMAA 2017a). Method #2 is based on RWSM estimates of annual stormwater runoff volumes and land use-based POC event mean concentrations (Wu et al. 2017). Additional details about the inputs and assumptions used to calculate annual average catchments POC loads using each of these methods are provided below.

2.4.2.1 HDS Catchment Loads – Method #1: BASMAA Land Use-Based Yields

This method relies on the land use-based mercury and PCBs yields that form the basis for the stormwater control measure load reduction accounting methodology described in the BASMAA Interim Accounting Methodology (BASMAA 2017a). These yields, presented in Table 2.2, provide an estimate of the mass of POCs contributed by an area of a given land use each year.

Table 2.2 Land Use-Based PCBs and Mercury Yields.

Land Use Category	PCBs Yield (mg/acre/year)	Mercury Yield (mg/acre/year)
Old Industrial	86.5	1,300
Old Urban	30.3	215
New Urban	3.5	33
Other	3.5	26
Open Space	4.3	33

For each of the HDS Unit catchments in this study, the area of each land use category identified in Table 2.2 was multiplied by the associated POC yield for that land use. The total POC load for each land use was summed to provide the total POC catchment loads for an average year.

2.4.2.2 HDS Catchment Loads - Method #2: RWSM Runoff Volume X Concentration

For this method, outputs of the RWSM were used to estimate annual average POC loads for each of the eight HDS unit catchments in this study. The RWSM was developed by SFEI (Wu et al., 2017) to serve as a regional scale planning tool for estimating average annual loads from small tributaries and sub-watersheds of San Francisco Bay. The RWSM includes a hydrology model that provides an estimate of runoff volumes for Bay Area watersheds and sub-watersheds, and pollutant models for PCBs and mercury that are driven by the hydrology and provide water concentration maps tied to land use classifications. The hydrology model calculates annual average runoff using rainfall data from PRISM (Parameter Elevation Regression on Independent Slopes Model, which is based on climate data from 1981 – 2010, www.prismclimate.org), and runoff coefficients developed from land use-soil-slope combinations. The hydrological calibration was based on 19 watersheds evenly distributed across three micro-climate sub-regions (East Bay, South Bay/ Peninsula, and North Bay for independent calibrations that averaged a mean bias of +1%, a median bias of 0% and a range of +/- 30%). One of the outputs from the model is a continuous estimate of runoff for the entire Bay area in GIS format which can be used to estimate flow from any spatial extent of interest (parcel, storm, sub-watershed, watershed, sub-region (e.g. county), or for the Bay area as a whole (Wu et al., 2017). This GIS map was used here to support this project. The RWSM PCBs and mercury pollutant models were calibrated using data from eight (PCBs) and six (mercury) well sampled watersheds. The calibration was deemed reasonable for PCBs and less good for mercury (Wu et al., 2017). One of the outputs from the model provides event mean concentration (EMC) data for stormwater by land use classification, as shown in Table 2.3.

Table 2.3 Event Mean Concentrations in Water for PCBs and Mercury by Land Use Classification from the Regional Watershed Spreadsheet Model¹.

Land Use Classification	Event Mean Concentrations (EMCs)	
	PCBs ng/L	Mercury (ng/L)
Ag and Open Space	0.2	72
New Urban		3
Old Residential	4	63
Old Commercial and Transportation	50	
Old Industrial	201	40
Source Areas		

¹Wu et al. 2017

It is important to note that the land use classifications shown in Table 2.3 are not exactly the same for PCBs and mercury, nor are they identical for the same pollutant in Tables 2.2 and 2.3. The differences include the following:

- The “old urban” classification in Table 2.2 combines the “old residential” and “old commercial and transportation” categories for PCBs, while these are distinct categories in Table 2.3;
- New Urban, Ag and Open space classifications in Table 2.3 all have the same EMC for PCBs, but are split into two separate categories (New Urban, and Ag/Open Space) with different EMCs for mercury, and with different PCBs yields for each category in Table 2.2.

For each HDS Unit catchment in this study, Equation 2-2 was used to calculate the average annual POC loads for the catchment, using RWSM inputs as described below.

$$(2-2) \quad M_{\text{Catchment-i}} = Q_{\text{Catchment-i}} \times C \times \text{EMC}_{\text{Catchment-i}}$$

Where:

$M_{\text{Catchment-i}}$ the total POC mass discharged from Catchment-i (the catchment draining to HDS Unit-i) over the time period of interest (mg/year);

$Q_{\text{Catchment-i}}$ the average annual runoff volume in catchment-i from the RWSM (liters/year);

C unit conversion factor (ng to mg);

$\text{EMC}_{\text{Catchment-i}}$ the area-weighted stormwater pollutant event mean concentration (EMC, ng/l) for Catchment-i based on land use. The RWSM land use-based EMCs in Table 2.3 (Wu et. al. 2017) were used to calculate an area-weighted pollutant EMC for each catchment based on the acreage of each land use classification in the catchment.

2.4.3 Evaluation of HDS Unit Performance

The HDS Unit performance was evaluated by calculating the annual percent removals of POCs due to cleanout of solids from HDS unit sumps. The percent removal of PCBs and mercury from the total estimated catchment mass for both of the catchment load estimate methods was calculated using Equation 2-3.

$$(2-3) \quad \text{Total Catchment Pollutant Mass Removed (\%)} = [M_{\text{HDS-i}}/M_{\text{Catchment-i}}] \times 100\%$$

Where:

$M_{\text{HDS-i}}$ the total POC mass captured in the sump of HDS Unit i over the time period of interest (mg/year);

$M_{\text{Catchment-i}}$ the total POC mass discharged from Catchment-i (the catchment draining to HDS Unit-i) over the time period of interest (mg/year) calculated using Method #1 or Method #2.

Two pollutant percent removals were calculated for each HDS unit catchment using Equation 2-3, including one for the catchment loads calculated using Method #1 (BASMAA land use-based yields) and the second for the catchment loads calculated using Method #2 (RWSM runoff volume x concentration).

3 RESULTS AND DISCUSSION

3.1 HDS UNIT SAMPLING

Figure 3.1 presents the range of catchment sizes treated by the 37 existing public HDS units in the Bay Area at the time of this project, and showing the land use distributions of each catchment. The cities of Oakland, Palo Alto, San Jose, and Sunnyvale all had HDS units that were scheduled for maintenance during the project period and met the logistical and safety constraints of the project. Between September 2017 and March 2018, sampling was attempted at 10 HDS units in these cities and completed successfully at the 8 units identified on Figure 3.1 and on the map in Figure 3.2. Although HDS units were selected for sampling opportunistically, the HDS units that were sampled span the range of catchment sizes treated by existing public HDS units in the Bay Area. The majority of HDS unit catchments (both sampled and not sampled) were dominated by old urban land use.

Additional information about each of the sampled HDS units is presented in Table 3.1. Figures 3.2 - 3.7 provide maps of the catchments for each of the sampled HDS units in this project.

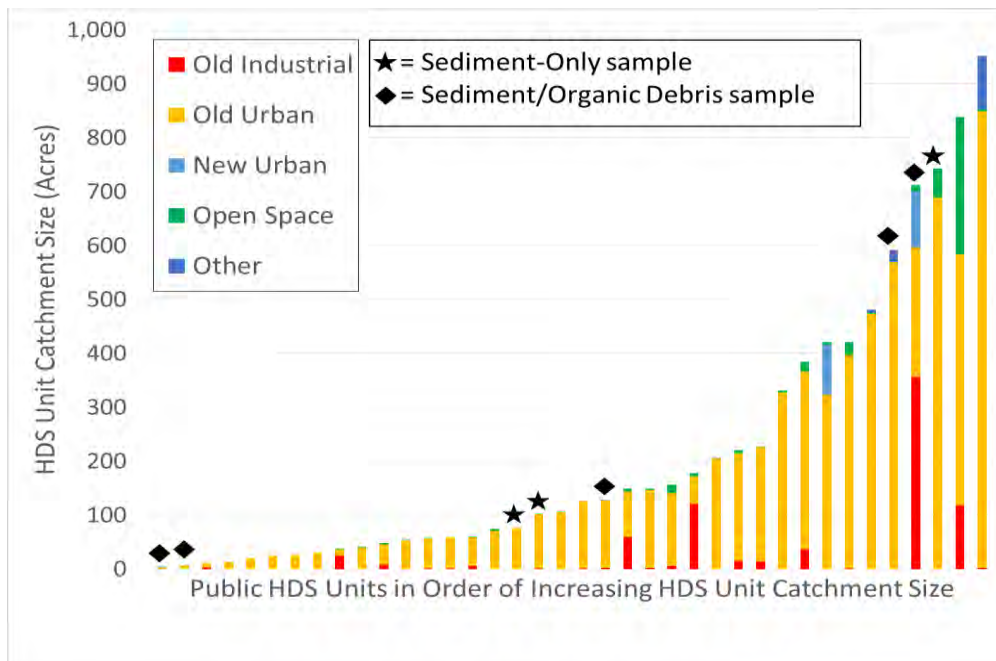

Figure 3.1 Catchment Sizes and Land Use Distributions for Existing Public HDS Units in the San Francisco Bay Area. The HDS units that were sampled in this study are identified with a black star (sediment-only samples collected) or diamond (sediment/organic debris samples collected).

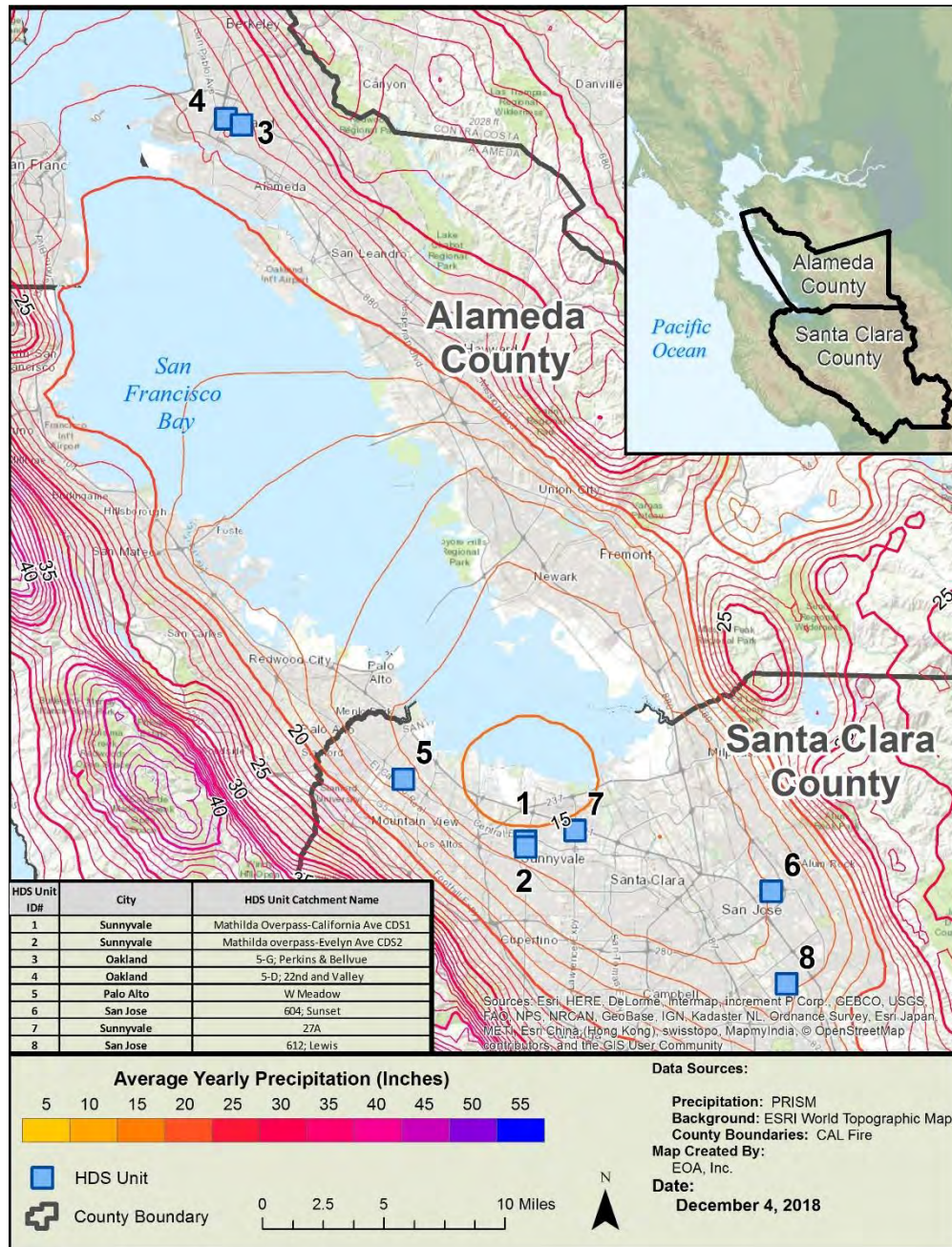

Figure 3.2 Overview Map of the 8 HDS Units Sampled in the San Francisco Bay Area as Part of the BASMAA BMP Effectiveness Study.

Table 3.1 HDS Units that were sampled in the San Francisco Bay Area as part of the BASMAA POC Monitoring for Management Action Effectiveness Study.

HDS ID	Date Installed	HDS Description	Lat	Long	Land Use Classification (Acres)					Total Area (Acres)
					Old Industrial	Old Urban ¹		New Urban	Ag/Open	
						Old Commercial/Other	Old Residential/Parks			
1	Sep-2014	Mathilda overpass project CDS1 at California Ave Sunnyvale, CA	37.38224	-122.03306	0.0	0.0	1.5	1.5	0.2	3.3
2	Sep-2014	Mathilda overpass project CDS2 at Evelyn Ave Sunnyvale, CA	37.37891	-122.03271	1.1	0.3	2.2	3.6	0.0	7.2
3	Aug-2010	HDS 5-G; Perkins & Bellevue (Nature Center) Oakland, CA	37.80744	-122.25597	0.0	5.3	70.0	0.0	0.0	75.3
4	Jul-2012	HDS 5-D; 22nd and Valley Oakland, CA	37.81109	-122.26787	1.8	73.2	27.0	0.0	0.3	102.3
5	Jun-2012	W. Meadow Drive and Park Blvd Palo Alto, CA	37.41816	-122.12538	2.9	17.6	73.9	32.5	0.8	127.5
6	Sep-2012	HDS 604; Sunset Avenue SW of Alum Rock Avenue San Jose, CA	37.35447	-121.84814	23.0	127.0	441.1	1.6	0.0	592.7
7	Sep-2015	HDS 27A -2 units (East Unit and West Unit) San Jose, CA	37.38922	-121.99592	269.6	136.2	11.3	282.6	11.9	711.6
8	Jun-2016	HDS 612; Lewis Road and Lone Bluff Way - Los Lagos Golf Course (2 units) San Jose, CA	37.29923	-121.83591	0.0	171.9	503.2	14.4	53.3	742.8

¹The “Old Urban” land use category in the Interim Accounting Methodology (2017a) was further divided into “Old commercial/other” and “Old Urban residential/parks” to provide consistency with the land use categories in the RWSM (Wu et al. 2017).



Figure 3.3 Map of HDS Units #1 and #2 Catchments in Sunnyvale, CA.

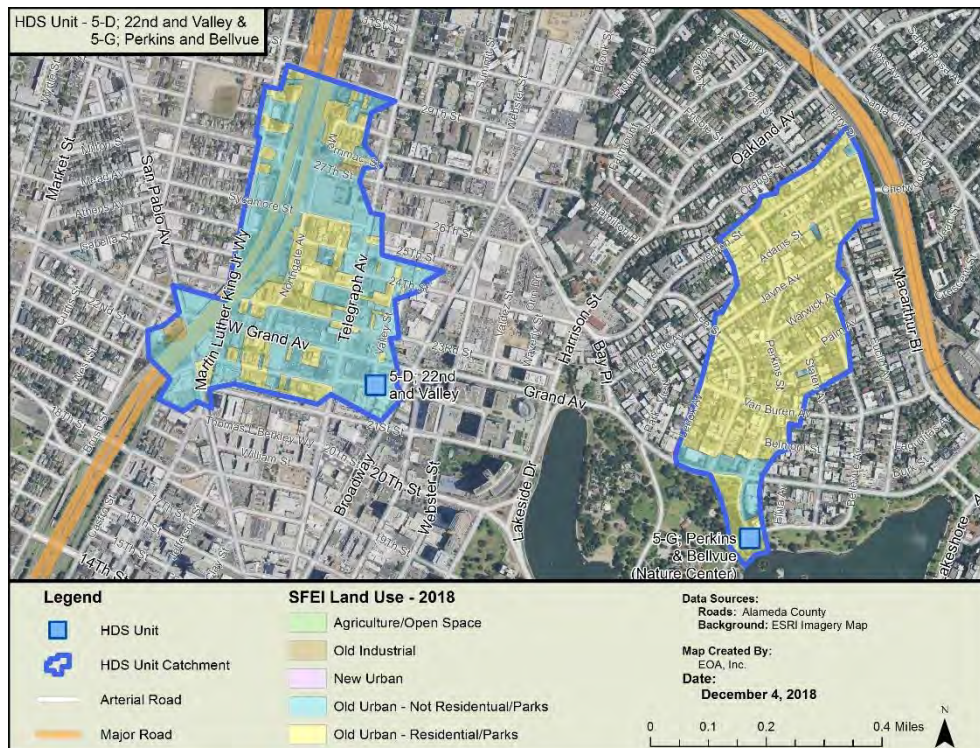

Figure 3.4 Map of HDS Units #3 and #4 Catchments in Oakland, CA

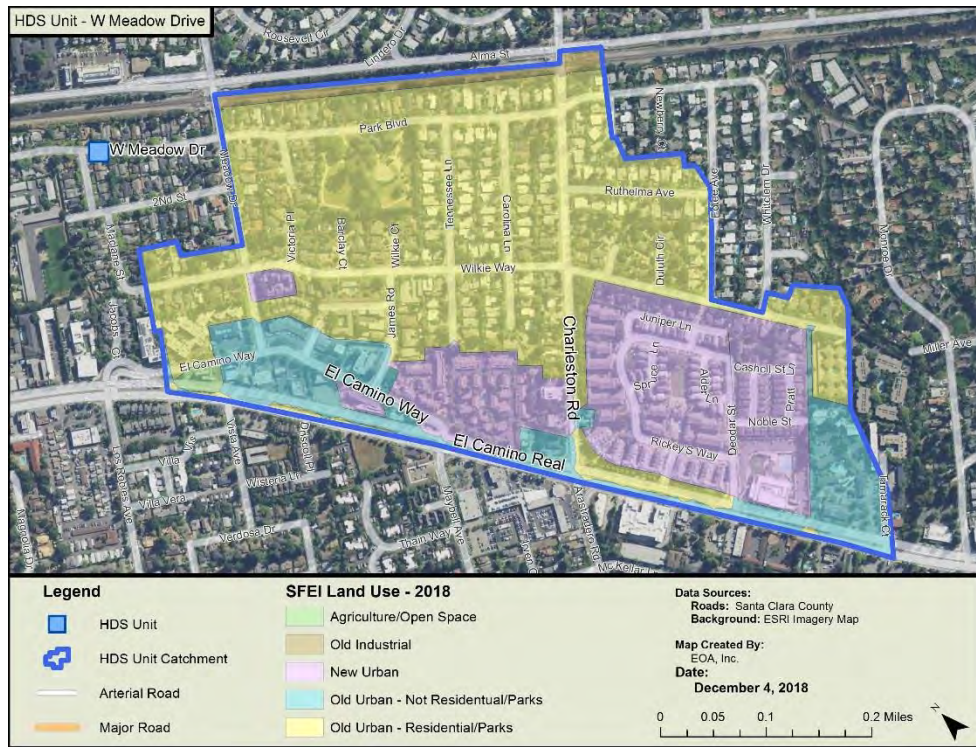

Figure 3.5 Map of HDS Unit #5 Catchment in Palo Alto, CA

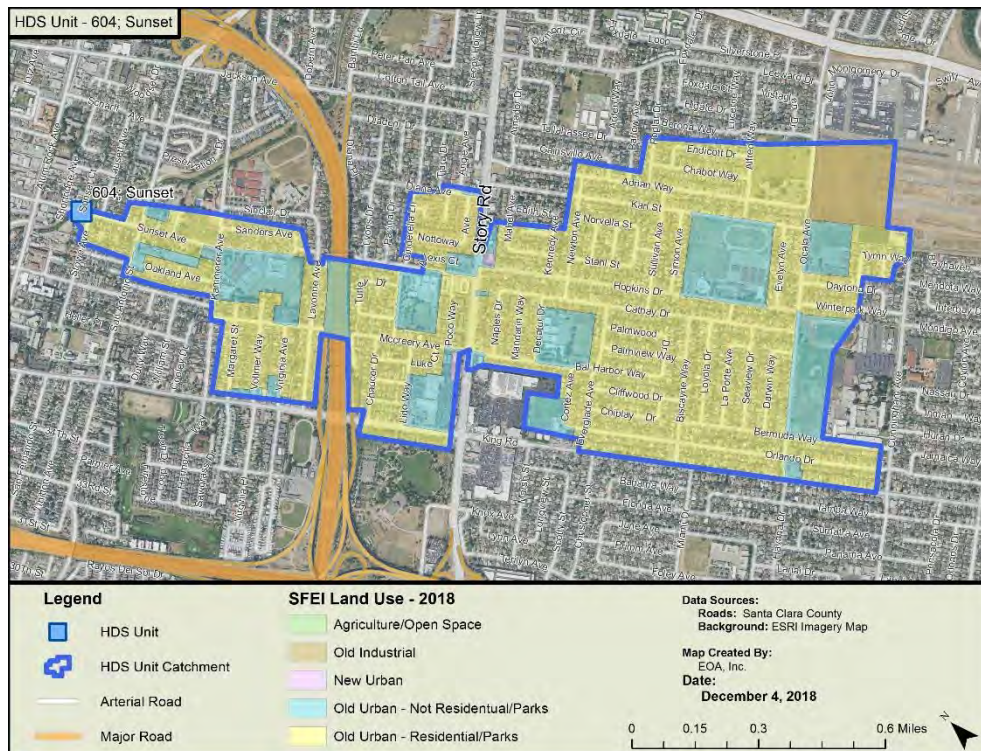

Figure 3.6 Map of HDS Unit #6 Catchment in San Jose, CA

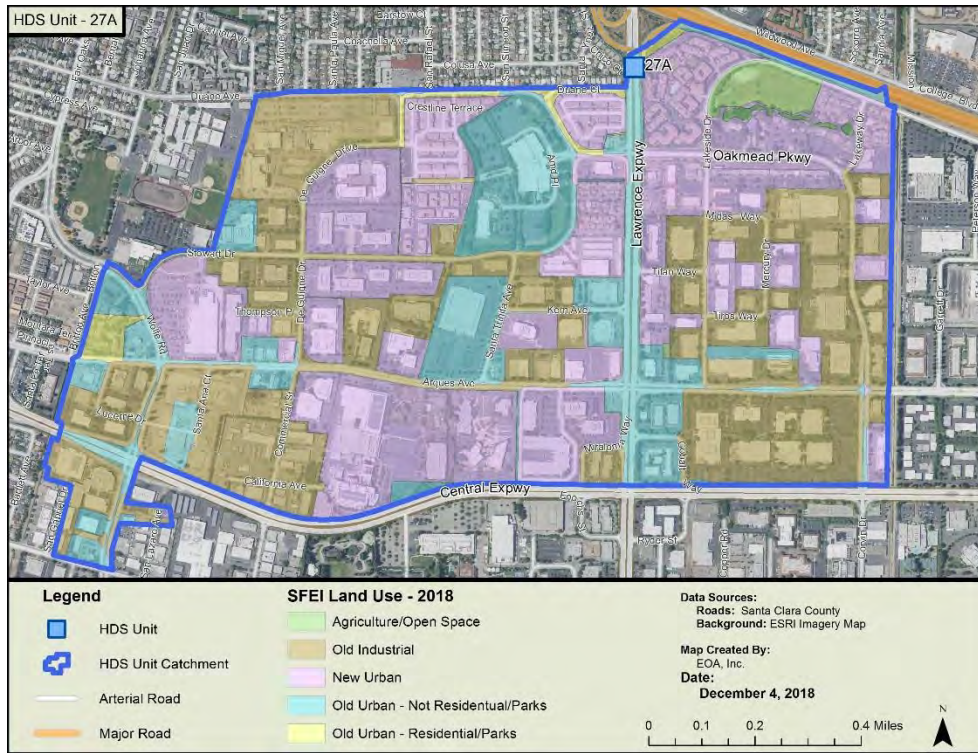

Figure 3.7 Map of HDS Unit #7 Catchment in Sunnyvale, CA

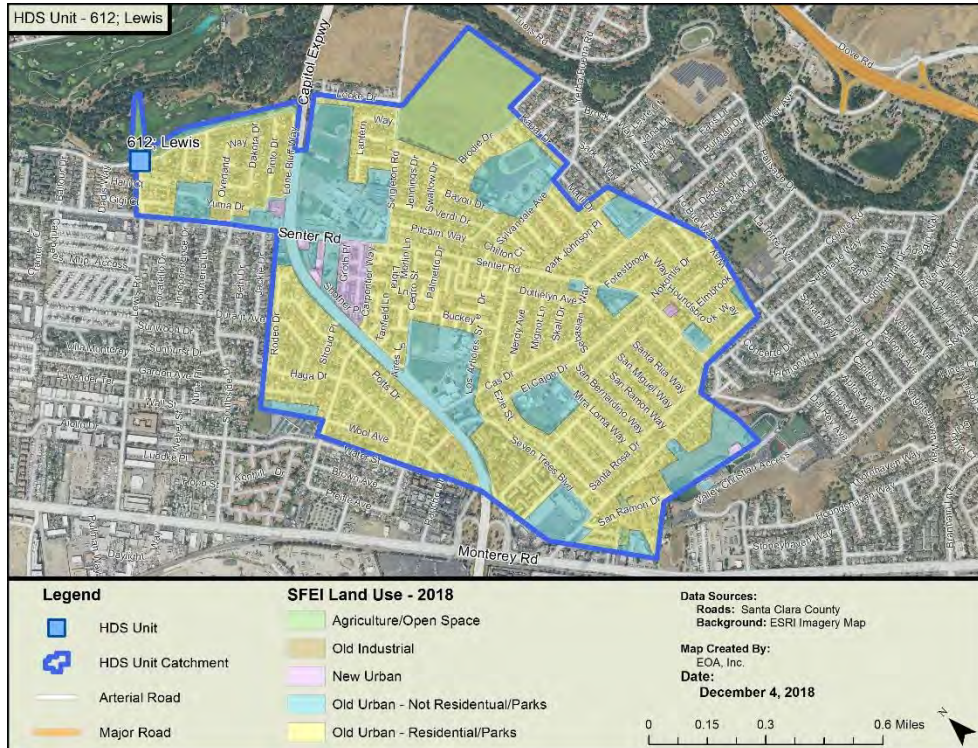

Figure 3.8 Map of HDS Unit #8 Catchment in San Jose, CA

3.1.1 Laboratory Analysis

3.1.1.1 Quality Assurance and Quality Control

Data Quality Assurance (QA) and Quality Control (QC) was performed in accordance with the project's SAP/QAPP (Appendix B). The SAP/QAPP established Data Quality Objectives (DQOs) to ensure that data collected are sufficient and of adequate quality for their intended use. These DQOs include both quantitative and qualitative assessments of the acceptability of data. The qualitative goals include representativeness and comparability, and the quantitative goals include completeness, sensitivity (detection and quantization limits), precision, accuracy, and contamination. Measurement Quality Objectives (MQOs) are the acceptance thresholds or goals for the data.

PCBs: The dataset included 8 field samples, with 3 blanks, and 5 laboratory control samples (LCS), some in duplicate, meeting the minimum number of QC samples required. Results were reported for the RMP 40 PCB analytes (with their coeluters, yielding 38 unique analytes). One sample was flagged for a hold time of one week too long but considered unlikely to affect results. Eight of the analytes were detected in blanks, but field sample concentrations were over 3-fold higher, so no results were censored. Two of the analytes had recovery with average >35% deviation from target values in the LCS, and one (PCB 183/185) had average error >70%, so was censored. PCB 183/185 was also flagged for poor precision (RSD 53%), but that analyte was already rejected for poor recovery, so the precision flag is largely moot. Overall the data quality was acceptable.

Mercury/TOC/TS/bulk density/TOM: The HDS sediment and sediment/organic debris dataset included eight field samples reported for total mercury, total solids, and bulk density, but only seven for TOC, and four (missing SJC-604) for sediment/organic debris for total volatile solids (total organic matter, TOM). MS/D pairs were reported for two sites for TOC, and mercury. Nine lab blanks were reported for mercury, and 6 for TOC, meeting the one per batch requirement. Three LCSs were also reported for TOC. Nearly all density and total solids were analyzed past the 1-one week QAPP listed hold times, and flagged VH, but so long as initial masses were recorded well, it is unlikely to affect results. Only Hg was occasionally detected in the blanks, but averaged <MDL so results were not flagged. Precision (<25% RPD) and recovery targets ($\pm 20\%$ for conventional analytes and $\pm 25\%$ for Hg) were met for all QC samples, so no other flags were added. Overall the data quality was acceptable.

Grain Size: The sediment dataset included three field samples reported for grain size, all analyzed in replicate. No blanks or recovery samples were reported, which is common for grain size analysis. Fourteen size fractions were reported, with results normalized from the raw lab reported percentages to yield sums of 100% for each analysis. Nominal percent differences in lab replicates for any given sample were always <5%, so no qualifier flags were added. Overall, the data quality was acceptable.

Additional details about the data quality review are provided in Appendix C. The laboratory QA/QC data are available upon request.

3.1.1.2 POC Concentrations

Chemical analysis results are summarized in Table 3.2. PCBs concentrations in this report are presented as the sum of the RMP-40 congeners; individual congener data are available in Appendix D. The laboratory reports from this project are available upon request. Of the eight samples collected, three

were sediment-only samples that were sieved at 2 mm prior to POC analysis. The remaining five samples were mixtures of sediment and organic debris (e.g., leaves). These samples were treated as a whole sample and not sieved at 2 mm prior to POC analysis. Upon consultation with the PMT, the project team decided to analyze these mixed sediment/organic debris samples as part of this study because these types of solids (i.e., leaf debris) appeared to be commonly captured in HDS unit sumps.

Total PCBs ranged from 0.01 to 0.41 mg/kg dry weight. The PCBs concentrations observed in the present study are at least an order of magnitude lower than PCBs concentrations observed in the solids removed from the 7th Street HDS Unit that drains the Leo Avenue area of San Jose observed in the CW4CB project in 2013 , where a known source property is located (BASMAA 2017c). Total mercury concentrations ranged from 0.005 to 0.31 mg/kg dry weight. Overall, the range of mercury and PCBs concentrations measured in the HDS unit solids in the present study were similar to the average concentrations found in storm drain sediments and street dirt across the Bay Area, as reported in Appendix B of the Interim Accounting Methodology (BASMAA 2017a). All laboratory data from this project are available upon request.

Table 3.2 Chemical Analysis Results of Solids Collected from HDS Unit Sumps.¹

HDS Unit ID	Sample ID	Sample Date	Sample Type	Bulk Density (g/cm ³)	Mercury (mg/kg dw)	TOC (%)	Total PCBs (mg/kg dw)	Total Solids (%)	Total Organic Matter (%)	Sediment Fraction < 2mm (%)
1	SUN-MatCDS1	3/8/18	Whole-Sediment/ organic debris	0.66	0.11	187	0.053	16.3	53.3	na
2	SUN-MatCDS2	3/8/18	Whole-Sediment/ organic debris	0.57	0.19	283	0.044	13.9	72.6	na
3	OAK-5-G	10/16/17	Sediment Only	0.53	0.25	3.64	0.092	88.5	na	67
4	OAK-5-D	2/2/18	Sediment Only	0.81	0.31	5.85	0.408	99.2	na	95
5	PAL-Meadow	10/25/17	Whole-Sediment/ organic debris	0.47	0.21	222	0.015	19.2	85.4	na
6	SJC-604	10/5/17	Whole-Sediment/ organic debris	0.99	0.04	nr	0.294	10.1	na	na
7	SUN-27A	3/8/18	Whole-Sediment/ organic debris	0.76	0.005	375	0.060	8.3	60.3	na
8	SJC-612-01	9/13/17	Sediment Only	0.74	0.14	3.78	0.012	98.3	na	93

¹na=not applicable; nr= not reported

3.2 EVALUATION OF HDS UNIT PERFORMANCE

3.2.1 HDS Unit Construction Details and Maintenance Records

Additional information was gathered about each of the sampled HDS units, including construction details and maintenance records provided by the corresponding municipality. The quantity and quality of the maintenance records varied greatly from city-to-city and even within a city, from unit to unit. After careful review of all the available data, relevant information on cleanout frequencies, volumes of solids removed, and the types of materials contained in the solids was compiled and used to estimate the volume of solids removed per cleanout (Table 3.3). These data include information on a total of 38 cleanouts at 7 HDS units (2 to 13 cleanouts for each HDS unit in this study with the exception of Palo Alto, for which no maintenance records were available at the time of this report). In most cases, the maintenance records provided estimates of the volume of solids removed from the sumps during cleanouts, as well as the volume of floatables and trash. Both the cities of Sunnyvale and San Jose also provided the depth of solids in the sump prior to cleanout. This later information was combined with the known dimensions of each unit's sump taken from the construction details to calculate the total volume of solids contained in the sump just prior to cleanout. Some records also provided basic descriptions of the types of solid materials that were removed from sumps during a cleanout and a rough estimate of the volume(s) of each type. Excluding cleanouts that only removed floatables, the average volume of solids removed per cleanout was calculated for each unit and reported in Table 3.3. These estimates ranged between 2.4 cubic yards (CY) and 37 CY. Interestingly, for five of the HDS units, the volume of solids removed exceeded the maximum storage capacity of the sumps, indicating solids were likely overflowing the sump and also contained within the neck and screening area above the sumps of these units. This suggests sump cleanouts may be needed more frequently at these units, which were typically cleaned once per year. In contrast, the average solids removed per cleanout for the two Oakland units ranged from 55% to 60% of the sump capacity, indicating the current cleanout frequency of 2 to 3 times per year appears adequate for these units.

When normalized to the total area of the catchment, the average volume of solids removed per cleanout ranged from 0.01 CY to 0.8 CY of solids per acre treated. The solids storage capacity for these 8 units had a similar range of 0.01 CY to 0.7 CY per acre treated. The similarities between measured storage capacity and estimated solids removed provides further corroboration that, on average, cleanouts were occurring when the sumps were full. This supports the use of the total sump storage capacity to represent the volume removed during a cleanout in cases where maintenance data were unavailable. This also suggests more frequent cleanouts may be warranted.

Table 3.3 Summary of Information on Storage Capacity, Cleanout Frequencies, and Volumes of Solids Removed from HDS Unit Sumps.

HDS Unit ID	HDS Catchment Description	Total Storage Capacity (CY) ^a	Sump Storage Capacity (CY) ^b	Cleanout Date	Description of Solids Removed From Unit	Solids Removed per Cleanout (CY)	Average Solids Removed per Cleanout (CY)
1	Mathilda overpass project CDS1 at California Avenue	4.9	2.2	12/19/2016	leaves/trash/debris	2.5	2.7
				8/29/2017	leaves/trash/debris	2.1	
				10/23/2018	leaves/trash/debris	3.5	
2	Mathilda overpass project CDS2 at Evelyn Ave	3.0	1.5	12/19/2016	leaves/trash/debris	1.8	2.4
				8/29/2017	leaves/trash/debris	2.8	
				10/23/2018	leaves/trash/debris	2.5	
3	HDS 5-G; Perkins & Bellvue (Nature Center)	17	5.8	4/12/2010	60% debris/20% organic/20%trash	2	3.5
				5/25/2010	floatables/organic debris	3	
				7/19/2010	25% sediment/75% Debris	1	
				2/2/2011	5% floatables/95% organic debris	3	
				4/25/2011	debris	3	
				1/12/2012	organic debris and floatables	3	
				4/18/2012	dirt and debris	1	
				10/18/2012	sediment debris	12	
				9/30/2014	sediment/trash	3	
				5/20/2015	floatables and sediment	3	
				5/22/2015	floatables and sediment	4	
5/19/2017	debris	7					
10/18/2017	sediment	1.1					
4	HDS 5-D; 22nd and Valley	28	7.3	7/7/2010	dirt/debris/organics	3	4.1
				2/4/2011	90% floatables/10% organic debris	4	
				1/10/2012	dirt/debris/organics	2.5	
				4/6/2012	dirt/debris/organics	3	
				10/17/2012	floatables/trash/debris	8	
				8/27/2013	debris	5	
				1/27/2015	sediment/trash	1	
				2/17/2016	sediment/debris	8	
4/29/2018	sediment debris	2					

Table 3.3 Cont...

HDS Unit ID	HDS Catchment Description	Total Storage Capacity (CY) ^a	Sump Storage Capacity (CY) ^b	Cleanout Date	Description of Solids Removed From Unit	Solids Removed per Cleanout (CY)	Average Solids Removed per Cleanout (CY)
5	W. Meadow Dr and Park Blvd	6.5	1.9	No Maintenance Data Available			
6	HDS 604; Sunset Avenue SW of Alum Rock Avenue	31	9.2	9/24/2016	trash/solids	14	10
				3/26/2017	trash/solids	9.5	
				10/5/2017	trash/solids	3.2	
				12/13/2017	trash/solids	12	
				3/6/2018	trash/solids	11	
7	HDS 27A -2 units (East Unit and West Unit)	68	18	12/21/2016	leaves/trash/debris	18	10.5
				8/30/2017	leaves/trash/debris	4.4	
				10/25/2018	leaves/trash/debris	8.7	
8	HDS 612; Lewis Road and Lone Bluff Way - Los Lagos Golf Course (2 units)	116	38	9/14/2017	trash/solids	37	37
				4/24/2018	trash/solids	37	

^aThe total storage capacity of each HDS unit was calculated from the dimensions of the solids storage sump and the screening area above the sump, as provided in construction plans.

^bThe sump storage capacity was calculated from the dimensions of the solids storage sump provided in the construction plans.

3.2.2 Mass of POCs Removed During Cleanouts

The estimated mass of POCs removed during HDS unit sump cleanouts is presented in Table 3.4 for the following assumed cleanout conditions (i.e., volumes of solids removed during each cleanout):

- the average volume of solids removed per cleanout from maintenance records; or
- for the Palo Alto HDS Unit #5 only, the volume of solids removed per cleanout was assumed to be equal to the sump capacity (because no maintenance data were available for this HDS unit);

For each HDS unit, the estimated mass of PCBs removed per cleanout ranged from < 1 mg to > 1,300 mg of PCBs. If we assume a cleanout rate of twice per year, the calculated mass of PCBs removed per year from all of these eight HDS units combined ranged from ~2,800 mg to ~6,000 mg of PCBs. When normalized to the catchment area, the mass of PCBs removed per acre treated ranged from 0.01 mg/acre/yr to 29 mg/acre/yr. The estimated mass of mercury removed per cleanout ranged from ~9 mg to > 3,200 mg, while the total mass of mercury removed per year from all eight HDS units combined (again, assuming 2 cleanouts per year) ranged from ~6,300 mg to 9,500 mg. The mass of mercury removed per acre treated ranged from 0.03 mg/acre/yr to 50 mg/acre/yr. For both PCBs and mercury, the larger catchments more frequently had lower rates of POCs per acre, although there was not a consistent correlation between catchment size and the mass of POCs in the sump.

Table 3.4 PCBs and Mercury Mass Removed During HDS Unit Sump Cleanouts.¹

HDS Unit ID	Total PCBs						Total Mercury					
	Mass of PCBs per CY of solids removed (mg)		Mass of PCBs removed per cleanout (mg)		Annual Mass of PCBs Removed (mg/Year)		Mass of Mercury per CY of solids removed (mg)		Mass of Mercury removed per cleanout (mg)		Annual Mass of Mercury Removed (mg/Year)	
	Low	High	Low	High	Low	High	Low	High	Low	High	Low	High
1	8	17	21	47	43	93	20	30	54	82	109	163
2	3	7	8	17	16	34	18	27	43	65	87	130
3	14	30	49	107	98	213	47	71	167	250	333	500
4	149	325	606	1,318	1,212	2,636	146	218	591	886	1,181	1,772
5	0.5	1.1	1.0	2.1	1.9	4.1	9	13	17	25	33	50
6	48	104	480	1,044	960	2,088	1.0	1.4	9.7	15	19	29
7	9	19	90	197	181	393	11	16	113	170	227	340
8	4	9	147	321	295	641	59	88	2,179	3,268	4,357	6,536
			Total Sum		2,807	6,104			Total Sum		6,347	9,520

¹The low and high estimates of mass of PCBs and mercury removed were calculated from the measured PCBs and mercury concentrations in this study and +/- mean RPD of Bay Area sediment PCBs concentrations of +/- 37% (PCBs) and +/- 17% (mercury), as described in Section 2.4.1.

3.2.3 HDS Catchment POC Loads and Calculated Percent Removals Due to Cleanouts

The annual POC loads discharged from each HDS Unit catchment calculated using Method #1 and Method #2, along with the calculated percent removals are presented in Tables 3.5 and 3.6 for PCBs and mercury, respectively. For the purpose of calculating descriptive statistics, percent removal was capped at 100%.

Table 3.5 HDS Unit Percent Removal of PCBs for Catchment Loads Calculated using Method #1 (Land use-based Yields) and Method #2 (RWSM Runoff Volume x Concentration).

HDS Unit ID	Method #1 Catchment Load Land Use-Based Yields				Method #2 Catchment Load RWSM Runoff Volume x Concentration			
	HDS Catchment Info		HDS Performance Annual Percent Removal		HDS Catchment Info		HDS Performance Annual Percent Removal	
	PCBs Yield (mg/acre/yr)	PCBs Load (mg/yr)	Low	High	PCBs Yield (mg/acre/yr)	PCBs Load (mg/yr)	Low	High
1	16	53	80%	100%	3	9	100%	100%
2	26	187	8%	18%	22	158	10%	22%
3	30	2,281	4%	9%	6	478	21%	45%
4	31	3,192	38%	83%	44	4,478	27%	59%
5	25	3,135	0.06%	0.13%	7	898	0.2%	0.5%
6	32	19,209	5%	11%	8	4,832	20%	43%
7	41	28,828	0.6%	1.4%	49	34,806	0.5%	1.1%
8	28	20,735	1.4%	3.1%	5	3,997	7%	16%
Median	29	3,164	5%	10%	8	2,447	15%	32%
Range	16 - 41	53 - 28,828	0.06%	100%	3 - 49	9 - 34,806	0.2%	100%

With the catchment loads calculated using Method #1, the PCBs percent removal varied greatly between HDS units, ranging from a low of <1% removal to a high of 100% removal. The median percent removal across all 8 units ranged from 5% to 10%.

With the catchment loads calculated using Method #2, the PCBs percent removal also varied greatly between HDS units, ranging from a low of <1% removal to a high of 100% removal. However, the median removal rate across all eight units was higher, ranging from 15% to 32%. Again, the variability in removal rates between individual HDS units was high. Generally, the percent removals were lower for a given HDS unit when the catchment loads were calculated using Method #1 compared with Method #2. Only HDS Unit #4 had a higher percent removal under Method #1.

Table 3.6 HDS unit Percent Removal of Mercury for Catchment Loads Calculated using Method #1 (BASMAA Land use-based Yields) and Method #2 (RWSM Runoff Volume x Concentration).

HDS Unit ID	Catchment Load for Method #1 BASMAA Land Use-Based Sediment Yields				Catchment Load for Method #2 RWSM Runoff Volume x Concentration			
	HDS Catchment Info		HDS Performance Annual Percent Removal		HDS Catchment Info		HDS Performance Annual Percent Removal	
	Mercury Yield (mg/acre/yr)	Mercury Load (mg/yr)	Low	High	Mercury Yield (mg/acre/yr)	Mercury Load (mg/yr)	Low	High
1	126	412	26%	40%	21.0	69	100%	100%
2	297	2,140	4%	6%	18.4	133	65%	98%
3	215	16,188	2%	3%	55.4	4,174	8%	12%
4	233	23,876	5%	7%	67.7	6,928	17%	26%
5	192	24,479	0.14%	0.20%	23.9	3,055	1.1%	1.6%
6	257	152,118	0.01%	0.02%	23.5	13,922	0.1%	0.2%
7	551	391,874	0.06%	0.09%	16.8	11,940	1.9%	2.8%
8	198	147,379	2%	3%	21.7	16,084	27%	41%
Median	224	24,177	2%	3%	23	5,551	13%	19%
Range	126 - 551	412-391,874	0.01%	40%	21 - 68	69 - 16,084	0.13%	100%

For mercury, the removal rates for catchment loads calculated using Method #1 ranged from 0.01% to 40% removal, and the median percent removal across all eight units ranged from 2% to 3%. The mercury removal rates for catchment loads calculated using Method #2 ranged from a low of <1% removal to a high of 100% removal. The median removal rate across all 8 units ranged from 13% to 19%. These results show the percent of mercury capture for both catchment load calculation methods was typically lower than for PCBs, which is consistent with observations in other studies of BMP effectiveness in the Bay Area (Gilbreath et al. 2019, David et al. 2015, Yee and McKee 2010).

One notable difference between the catchment load calculation methods presented in Tables 3.5 and 3.6 is that the catchment-specific yields (POC mass per acre per year) calculated for the same HDS unit catchment under each method are substantially different. The RPDs for the paired catchment-specific yields calculated under Scenario 1 and Scenario 2 ranged from 3% to 67%, with an average of 39% for PCBs. Also, for PCBs the differences in catchment yields for a given unit were not consistently higher or lower for Method #1 vs. Method #2 catchment load estimates. The RPDs between catchment yields under the 2 loading scenarios for each HDS unit were generally larger for mercury, ranging from 47% to 90%, with an average of 68%.

Overall, the results of this study indicate the HDS unit performance appears to vary substantially between units, regardless of the method used to estimate the catchment loads. Even when normalized to the area of the HDS unit catchment, the POCs removed per acre treated were highly variable between units, ranging up to over a thousand fold difference between the highest and lowest capture rates. The method used to calculate the catchment annual loads also impacts the calculated performance of the individual HDS units.

3.2.4 Limitations

It is important to note, that all of the assumptions that were used in the calculations described in this report represent important limitations of this study and highlight the paucity of data that are currently available to evaluate HDS Unit performance for PCBs and mercury removals. Although this study provided new data on the concentrations of POCs in the solids removed from HDS unit sumps during cleanouts, the data set remains small ($n=8$), especially in comparison to the expected (and observed) variability between each unit. The calculated removal rates, even under the same loading scenario, were highly variable across different HDS Units, ranging from almost zero POC removal, to 100% removal of all POCs discharged from the catchment. Although an estimate of variability in POC concentrations was applied based on information about the variability in street dirt and storm drain sediments, the authors of this report acknowledge this estimated variability likely falls far short of accounting for the full range of variability and error in the input parameters used to calculate the POC removal rates presented here. Much more data would be needed to improve these estimates and better characterize the true variability in removal rates between units, and within the same unit over time.

One data input that proved particularly difficult to account for was the volume of solids (and associated mass) that was removed from HDS units during each cleanout. This study relied on the limited information recorded in maintenance records provided by individual cities for each of the HDS units in this study. The information that was provided varied from cleanout to cleanout, and from city to city. Although some cities provided measurements of the depth of solids in a unit at cleanout, which allowed a more accurate calculation of the total solids volume, in many cases, the information provided was likely based on a visual assessment by the maintenance staff onsite at the time of the cleanout, and thus subject to a large degree of error.

Nevertheless, this study increased the number of data points on POC concentrations in the solids removed from HDS Unit sumps during cleanouts from $n=2$ (the Leo Ave HDS data from CW4CB) to $n=10$, an increase of 500%. Furthermore, because of the careful review of maintenance records that was performed as part of this study, the authors were able to identify a number of recommendations (provided in Section 4) for improving the removal effectiveness of HDS unit maintenance practices, and improving the quality of maintenance records for the purpose of quantifying solids removed, and the volume of solids associated with pollutants.

4 CONCLUSIONS

The Project combined sampling and modeling efforts to evaluate the mercury and PCBs removal performance of HDS units. Samples of the solids captured in 8 HDS units in the Bay Area were collected and analyzed for PCBs and mercury. The monitoring data collected by this project provided partial fulfillment of MRP monitoring requirements for management action effectiveness under provision C.8.f., and also addressed some of the data gaps on BMP effectiveness that were identified by the CW4CB project (BASMAA, 2017b). This study also reviewed information on HDS Unit maintenance practices, including the frequency of cleanouts, the volumes of solids removed during these cleanouts, and the types of materials contained within the solids. This information was used to develop estimates of the average solids removal per cleanout, and combined with concentration data, the mass of mercury and PCBs removed per cleanout. Finally, the percent removals achieved by HDS unit cleanouts were calculated using two different methods to estimate the catchment loads, including BASMAA land use-based pollutant yields (BASMAA 2017a), and RWSM runoff-concentration load estimates (Wu et al. 2017).

Based on median values, the results of this study suggest HDS unit maintenance practices reduce loads of PCBs from 5% to 32%, while mercury load reductions are lower, ranging from 3% to 19%. For both PCBs and mercury, the data from this study demonstrate the percent removals achieved by HDS unit cleanouts are highly variable across units, and likely variable within the same unit over time.

The conclusions on pollutant removal effectiveness of HDS unit sump cleanouts based on the results of this study are limited by the small number of HDS units that were sampled (n=8) and the limited, and often incomplete, maintenance records that were available at the time of this study. Nevertheless, the results of this study provide new information on the range of pollutant concentrations measured in HDS unit sump solids. Much more data would be needed to fully characterize the range of pollutant load reductions achieved by HDS units over longer periods of time and across varying urban environments.

In addition to the conclusions above, this study also identified the following suggestions for potentially increasing the PCBs and mercury removal effectiveness of HDS unit maintenance practices, and to improve the quality of the data available for calculating loads reduced. First, review of maintenance records indicated that the HDS unit sumps were often full or nearly full when the cleanouts occurred. Because no pollutant removal can occur after the sumps are 100% full, conducting cleanouts well before capacity is reached would likely improve pollutant removal rates for a given unit. However, given the site-specific nature of sump loading and variability across time, both the cleanout frequency and the cleanout methods required are likely to be highly site-specific. Development of site-specific standard operating procedures (SOPs) for cleanout frequency and cleanout methods for each HDS unit may be needed to ensure efficient and consistent practices over time. Frequent inspections of HDS unit sumps may also provide the information needed to determine an appropriate cleanout frequency for each HDS unit.

Second, review of maintenance records highlighted the need for more detailed and consistent reporting on each cleanout. The maintenance records provided by municipalities in this study varied considerably in the quantity and quality of the information provided. The variability was high both between cities,

and within cities for the same unit over time. To improve estimates of the solids removal achieved per cleanout (and the associated pollutant removals achieved), consistent recording of the following information for each cleanout would be useful.

- cleanout date
- measured depth of solids in the sump prior to cleanout;
- measured depth of water in the sump prior to cleanout;
- an estimate of the volume of water removed during the cleanout;
- an estimate of the volume of solids removed during the cleanout;
- a description of the materials contained in the sump solids – including estimates of the percent contribution by volume of sediment, organic materials (leaves and vegetation), trash and large debris, and floatables;
- clearly identify all cleanouts that ONLY remove floatables;

The information above would provide better estimates of the solids removed per cleanout, and a better understanding of the solids captured in HDS units that are likely associated with POCs. Both pieces of information are important for improving estimates of pollutant removal effectiveness of HDS unit cleanouts. This information could also be reviewed periodically to determine if the appropriate cleanout frequencies are being maintained.

5 REFERENCES

- BASMAA, 2017a. Interim Accounting Methodology for TMDL Loads Reduced. Bay Area Stormwater Management Agencies Association.
- BASMAA, 2017b. Clean Watersheds for a Clean Bay Project Report, Final Report May 2017. Bay Area Stormwater Management Agencies Association.
- BASMAA, 2017c. Clean Watersheds for a Clean Bay Task 5: Stormwater Treatment Retrofit Pilot Projects - 7th Street Hydrodynamic Separator Unit draining the Leo Avenue Watershed, San Jose, CA. Bay Area Stormwater Management Agencies Association.
- Contech Engineered Solutions LLC, 2014. CDS Guide: Operation, Design, Performance and Maintenance. Available at www.conteces.com.
- David, N., Leatherbarrow, J.E, Yee, D., and McKee, L.J, 2015. Removal Efficiencies of a Bioretention System for Trace Metals, PCBs, PAHs, and Dioxins in a Semi-arid Environment. *Journal of Environmental Engineering*, 141(6) (June).
- Gilbreath, A.N, McKee, L.J., Shimabuku, I., Lin D., Werbowski, L.M., Zhu, X., Grbic, J., Rochman, C., 2019 (accepted). Multi-year water quality performance and mass accumulation of PCBs, mercury, methylmercury, copper and microplastics in a bioretention rain garden. *Journal of Sustainable Water in the Built Environment*.
- Santa Clara County, 2007. Santa Clara County California Drainage Manual 2007. Prepared by Schaaf & Wheeler for Santa Clara County. August 14, 2007.
- SCVURPPP, 2018. Pollutants of Concern Monitoring Data Report. Water Year 2017. Santa Clara Valley Urban Runoff Prevention Program. March 31, 2018.
- SFBRWQCB, 2012. San Francisco Bay Regional Water Quality Control Board. Total Maximum Daily Loads (TMDLs) and the 303(d) List of Impaired Water Bodies. 2012.
- SFBRWQCB, 2015. Municipal Regional Stormwater NPDES Permit, Order No. R2-2015-0049. NPDES Permit No. CAS612008. November 19, 2015
- SMCWPPP, 2018. Pollutants of Concern Monitoring Data Report. Water Year 2017. San Mateo Countywide Water Pollution Prevention Program. March 29, 2018.
- Wu, J; Gilbreath, A.; McKee, L. J. 2017. Regional Watershed Spreadsheet Model (RWSM): Year 6 Progress Report. SFEI Contribution No. 811. San Francisco Estuary Institute: Richmond, CA.
- Yee, D., and McKee, L.J., 2010. Task 3.5: Concentrations of PCBs and Hg in soils, sediments and water in the urbanized Bay Area: Implications for best management. A technical report of the Watershed Program. SFEI Contribution 608. San Francisco Estuary Institute, Oakland CA 94621. 36 pp. + appendix. <http://www.sfei.org/documents/concentrations-pcbs-and-hg-soils-sediments-and-water-urbanized-bay-area-implications-best>.

APPENDIX A: FINAL STUDY DESIGN

POC Monitoring for Management Action Effectiveness

Monitoring Study Design

Final, September 2017

Prepared for:



Prepared by:



1410 Jackson Street
Oakland, California
94612



WATER PROGRAMS
SACRAMENTO STATE

6000 J Street
Sacramento, California
95819



4911 Central Avenue
Richmond, California
94804

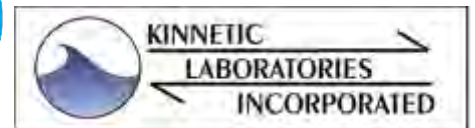

307 Washington Street
Santa Cruz, California
95060

Contents

	List of Tables	3
	List of Figures	3
1.	Introduction.....	4
2.	Problem Definition	5
	2.1 HDS Units.....	5
	2.2 Bioretention	7
3.	Study Goals.....	10
	3.1 Primary Management Questions	10
	3.2 Secondary Management Questions	10
	3.3 Level of Confidence.....	11
4.	Study Design Options.....	12
	4.1 Influent-Effluent Monitoring.....	13
	4.2 Sediment Sampling	14
	4.3 Before-After Monitoring	15
5.	Primary Data Objectives.....	16
	5.1 Data Objective 1: Annual Loads Captured by HDS Units	16
	5.2 Data Objective 2: Loads Reduced by Biochar-Amended BSM.....	16
6.	BMP Processes and Key Study Variables.....	18
	6.1 HDS Units.....	19
	6.2 Bioretention	20
7.	Monitoring and Sampling Options.....	21
	7.1 HDS Units.....	21
	7.1.1 Influent Quality.....	21
	7.1.2 BMP Design and Hydraulic Loading	24
	7.1.3 Operation and Maintenance	26
	7.2 Enhanced Bioretention	26
	7.2.1 Influent Quality.....	26
	7.2.2 BMP Design and Hydraulic Loading	27
	7.2.3 Media Type and Properties.....	27
	7.2.4 Operation and Maintenance Parameters	29
	7.3 Uncontrolled Variables and Study Assumptions	29
8.	Final Study Design	31
	8.1 Statistical Testing & Sample Size	31
	8.2 Constituents for Sediment Analysis	31
	1 – Only total mercury analyzed. Methyl mercury is not	32
	relevant for SF Bay TMDL	32
	8.3 Constituents for Water Quality Analysis.....	32
	1 – Only total mercury analyzed. Methyl mercury is not	33
	relevant for SF Bay TMDL	33
	8.4 Budget and Schedule	33
	8.5 Optimized Study Design	33
	8.6 Adequacy of Study Design	37
9.	Recommendations for Sampling and Analysis Plans.....	39

9.1	HDS Monitoring	39
9.2	Enhanced Bioretention Media Testing	39
9.3	Data Quality Objectives	40
10.	References	41

List of Tables

Table 2.1	Summary of Data Collected from Leo Avenue HDS during October, 2014 Annual Cleanout Event.....	6
Table 2.2	Summary of Bay Area Drain Inlet Sediment Concentration Data.....	6
Table 7.1	HDS Sampling Design based on Watershed Land Use	22
Table 7.2	Percent of Land Use in HDS Watershed Areas.....	23
Table 7.3	HDS Sampling Design based on Predominant Land Use	24
Table 7.4	HDS Sampling Design based on Predominant Land Use and HDS Size	25
Table 7.5	Example Sampling Design for Laboratory Column Experiments	28
Table 8.1	Selected Constituents for HDS Sediment Monitoring	32
Table 8.2	Selected Aqueous Constituents for Media Testing in Laboratory Columns	33
Table 8.3	HDS Monitoring Study Design.....	35
Table 8.4	Enhanced BSM Testing Study Design	36

List of Figures

Figure 2.1	Cumulative Frequency Distribution of Total PBCs Influent Concentrations for Bioretention Media with and without Biochar.....	8
Figure 4.1	Typical BMP system and pollutant pathways	12
Figure 4.2	Comparison of two hypothetical non-overlapping BMP regressions.....	14
Figure 7.1	Land Use based PCB and Mercury Loading based on BASMAA Integrated Monitoring Reports (SFEI, 2015).....	22

1. Introduction

Discharges of PCBs and mercury in stormwater have caused impairment to the San Francisco Bay estuary. In response, the Regional Water Board adopted total maximum daily loads (TMDLs) to address these pollutants of concern (POC) (SFBRWQCB, 2012). Provisions C.11 and C.12 the Municipal Regional Stormwater NPDES Permit, MRP (SFBRWQCB, 2015) implement the Mercury and PCB Total Maximum Daily Loads (TMDLs) for the San Francisco Bay Area. These provisions require mercury and PCB load reductions and the development of a Reasonable Assurance Analysis (RAA) demonstrating that control measures will be sufficient to attain the TMDL waste load allocations within specified timeframes. Provision C.8.f of the MRP supports implementation of the mercury and PCB TMDLs provisions by requiring that Permittees conduct pollutants of concern (POC) monitoring to address the five priority information needs listed below.

1. *Source Identification* – identifying which sources or watershed source areas provide the greatest opportunities for reductions of POCs in urban stormwater runoff;
2. *Contributions to Bay Impairment* – identifying which watershed source areas contribute most to the impairment of San Francisco Bay beneficial uses (due to source intensity and sensitivity of discharge location);
3. *Management Action Effectiveness* – providing support for planning future management actions or evaluating the effectiveness or impacts of existing management actions;
4. *Loads and Status* – providing information on POC loads, concentrations, and presence in local tributaries or urban stormwater discharges; and
5. *Trends* – evaluating trends in POC loading to the Bay and POC concentrations in urban stormwater discharges or local tributaries over time.

Table 8.2 of Provision C.8.f identifies the minimum number of samples that each MRP Countywide Program (i.e., Santa Clara, San Mateo, Alameda, and Contra Costa) must collect and analyze to address each monitoring priority. Although individual Countywide monitoring programs can meet these monitoring requirements, some requirements can be conducted more efficiently and will likely yield more valuable information if coordinated and implemented on a regional basis. The minimum of eight (8) PCB and mercury samples required by each Program to address information priority #3 is one such example. Findings from a regionally-coordinated monitoring effort would better support development of the RAA.

This Study Design describes monitoring and sample collection activities designed to meet the requirements of information priority #3 of Provision C.8.f of the MRP. The activities planned include field sampling of hydrodynamic separators and laboratory experiments with amended bioretention soils. Study planning is important to ensure that the right type of data are collected and there is a sufficient sample size and power to help address the management questions within the available time and budget constraints. Essential components of the study plan include describing problems, defining study goals, identifying important study parameters, specifying methodologies, and validating and optimizing the study design.

2. Problem Definition

Studies conducted to date have identified PCB source areas in the Bay Area where pollutant management options may be feasible and beneficial. Enhanced municipal operational PCB management options (e.g., street sweeping, storm drain line cleanout) have the advantage of being familiar and well-practiced, address multiple benefits, and the cost-benefit may exceed that for stormwater treatment (BASMAA, 2017a). Site-specific stormwater treatment via bioretention, however, is now commonly implemented to meet new and redevelopment (MRP Provision C.3) requirements. An added benefit of redevelopment is that PCB-laden sediment sources can be immobilized. However, many areas where certain land uses or activities generate higher PCB concentrations in runoff are unlikely to undergo near-term redevelopment, and instead may only be subject to maintenance operations or stormwater BMP retrofit projects implemented by the municipality. Consequently it is valuable to maximize cost effective PCB removal benefit of both operations and maintenance, and stormwater treatment.

Two treatment options that have the potential to reduce PCB discharges include hydrodynamic separators (HDS units) and enhanced bioretention filters. These options were pilot-tested in the Clean Watersheds for a Clean Bay (CW4CB) Project (BASMAA, 2017a). HDS units are being implemented for trash control throughout the Bay Area and collect sediment to some extent along with trash and other debris. Quantifying PCB mass removed by these units will help MRP Permittees account for the associated load reductions. For these and other control measures, an Interim Accounting Methodology has been developed based on relative mercury and PCBs yields from different land use categories (BASMAA, 2017c). Bioretention is a common treatment practice for new development and redevelopment in the San Francisco Bay Area, so enhancing the performance of bioretention is also attractive.

At this time reducing mercury loads in stormwater runoff is a lower priority than PCBs load reduction. The assumption during the MRP 2.0 permit term is that actions taken to reduce PCBs loads in stormwater runoff are generally sufficient to address mercury. Therefore, optimizing stormwater controls for PCBs is the primary focus in this study.

2.1 HDS Units

Limited CW4CB monitoring conducted at two HDS sites was used to calculate the mass of PCBs in trapped sediment (BASMAA, 2017a). The two sites sampled were Leo Avenue in San Jose and City of Oakland Alameda and High Street. The Leo Avenue HDS unit treats runoff from approximately 178 acres of watershed with a long history of industrial land uses, including auto repair and salvage yards, metal recyclers, and historic rail lines. The City of Oakland Alameda and High Street HDS has a tributary drainage area of approximately 35 acres with a high concentration of old industrial and commercial land uses, including historic rail lines.

Sampling of the two CW4CB HDS units was opportunistic and associated with scheduled cleanouts. Two sump cleanout events took place in August 2013, one at the Leo Avenue HDS unit and one at the Alameda and High Street HDS unit. However, due to a lack of captured sediment the samples collected were aqueous phase samples instead of sediment samples. An additional cleanout took place at Leo Avenue in October 2014. A sump sediment sample

collected and analyzed during this cleanout contained total PCB concentrations of 1.5 mg/kg and mercury concentrations of 0.33 mg/kg for sediment less than 2 mm in size, and estimated annual total PCB and mercury removals were 375 mg and 82.4 mg, respectively (Table 2.1). The HDS sediment concentrations are comparable to previous Leo Avenue watershed measurements in sediments from piping assessed via manholes, drop inlets/catch basins, streets/gutters, and private properties (ND to 27 mg/kg for PCBs and 0.089 to 6.2 mg/kg for mercury) (BASMAA, 2014). At the Alameda and High Street HDS unit, tidal influences of Bay water prevented additional monitoring.

Table 2.1 Summary of Data Collected from Leo Avenue HDS during October, 2014 Annual Cleanout Event

Parameter	Result	Units
Volume of Sediment Removed	4	Cubic yards
Total PCBs Concentration	1.5	mg/Kg
Mercury Concentration	0.33	mg/Kg
Bulk density	0.67	g/cm ³
Percent solids	39	%
Particle Size (< 2 mm)	31	%

There are no known published studies characterizing HDS sediment for PCBs or mercury, so the Leo Avenue results are compared to relevant drain inlet/catch basin sediment studies. In the Bay Area, different municipalities have collected and analyzed drain inlet cleaning sediment samples. The analytical results for these drain inlet sediment samples are summarized in Table 2.2 (BASMAA, 2014). As can be seen from Table 2.2, the Leo Avenue sediment PCB concentrations are higher than those measured in Bay Area drain inlet sediment by up to an order-of-magnitude, but mercury concentrations are comparable.

Table 2.2 Summary of Bay Area Drain Inlet Sediment Concentration Data

(Based on readily available data; see BASMAA (2016b) for additional summaries for street and storm drain sediment)

Municipality	PCBs			Mercury		
	No. Drain Inlet Sediment Samples	Mean PCB DI Sediment Concentration (mg/Kg)	Median PCB DI Sediment Concentration (mg/Kg)	No. Drain Inlet Sediment Samples	Mean Mercury DI Sediment Concentration (mg/Kg)	Median Mercury DI Sediment Concentration (mg/Kg)
Fairfield & Suisun	8	0.244	0.055	16	0.510	0.228
San Mateo County Municipalities	29	0.318	0.123	28	0.160	0.147
San Carlos	22	0.267	0.129	25	0.167	0.147
Alameda County Municipalities	47	0.294	0.122	75	0.384	0.204
Berkeley	8	0.147	0.122	11	0.343	0.241
Oakland	24	0.402	0.155	28	0.539	0.297
San Leandro	11	0.219	0.106	21	0.230	0.151
Contra Costa County Municipalities	46	0.515	0.168	48	0.413	0.308
Richmond	31	0.736	0.482	28	0.460	0.349

Notes:

Mean and median drain inlet sediment concentrations were calculated from the SFEI database (SFEI 2010, KLI and EOA 2002; City of San Jose and EOA 2003).

Monitoring by the City of Spokane, Washington, showed total PCBs in catch basin sediment ranged between 0.025 mg/kg and 1.7 mg/kg for an industrial area with known PCB contamination (City of Spokane, 2015). A City of San Diego study characterized sediments in eight catch basins in a 9.5 acre area of downtown San Diego classified as high density mixed use with roads, sidewalks, and parking lots (City of San Diego, 2012). Concentrations of common aroclors in the catch basin sediments varied from about 0.040 to over 0.9 mg/kg. Monitoring by the City of Tacoma showed PCB concentrations in stormwater sediment traps varied from nondetect to a maximum near 2 mg/kg (City of Tacoma, 2015). The highest PCB concentrations in catch basin sediments ranged from 16 mg/kg in downtown Tacoma to 18 mg/kg in East Tacoma. These published drain inlet/catch basin studies show that PCB and mercury concentrations can vary substantially in storm drain sediments depending on the characteristics of the watershed.

Sampling of captured sediment at the Leo Avenue HDS in San Jose highlighted the potential of HDS maintenance as a management practice for controlling PCB and mercury loads. The BASMAA Interim Accounting Methodology that is currently being used to calculate load reductions assumes a default 20% reduction of the area-weighted land-used based pollutant yields for a given catchment. This default value was based on average percent removal of TSS from HDS units based on analysis of paired influent/effluent data. However, significant data gaps remain in determining the effectiveness of this practice and expected load reductions. HDS sediment sampling has been limited to a few samples. PCB concentrations in the Leo Avenue HDS sample were much higher than average concentrations in Bay Area drain inlet sediment. Drain inlet/catch basin sediment sampling by others suggests that sediment PCB and mercury concentrations can vary substantially from watershed to watershed. **The monitoring performed to date is not sufficient to characterize pollutant concentrations of sediment captured in HDS units that drain catchments with different loading scenarios (e.g., land-uses, stormwater volumes, etc.), nor to estimate the percent removal based on the pollutant load captured by the HDS unit. Additional sampling is needed to better quantify the PCB and mercury loads capture by these devices, and calculate the percent removal achieved.** Consequently, quantification of PCBs removed at other HDS locations and evaluation of the percent load reduction achieved is needed to provide better estimates of PCB load reductions from existing HDS unit maintenance practices.

2.2 Bioretention

The results of monitoring the performance of bioretention soil media (BSM) amended with biochar at one CW4CB pilot site suggest that the addition of biochar to BSM is likely to increase removal of PCBs in bioretention BMPs. Biochar is a highly porous, granular material similar to charcoal. In the CW4CB study, the effect of adding biochar to BSM was evaluated using data collected from two bioretention cells (LAU 3 and LAU 4) at the Richmond PG&E Substation 1st and Cutting site. At this site, cell LAU 3 contains standard engineered soil mix (60% sand and 40% compost) while cell LAU 4 contains a mix of 75% standard engineered soil and 25% pine wood-based biochar (by volume).

Figure 2.1 shows a cumulative frequency plot of influent and effluent PCB concentrations for the two bioretention cells. Although influent PCB concentrations at the two cells were generally similar, effluent PCB concentrations were much lower for the enhanced bioretention

cell (LAU 4) compared to those for the standard bioretention cell (LAU 3). The results for total mercury were different from those for PCBs, with both cells demonstrating little difference between influent and effluent concentrations. These CW4CB monitoring results suggest that the addition of biochar to BSM may increase removal of PCBs but not mercury from stormwater. However, analysis of methylmercury indicated that BSM may encourage methylation while biochar may mitigate the effect such that there is no substantial transformation of mercury to methylmercury. Tidal influences at 1st and Cutting also may be a contributing factor that should be controlled in future study.

The majority of biochar research conducted to date has focused on agricultural applications, where biochar has been shown to improve plant growth, soil fertility, and soil water holding, especially in sandier soils. Only a handful of field-scale projects have investigated the effects of biochar in stormwater treatment and no known field studies have investigated removal of mercury or PCBs from stormwater by biochar-amended media.

A recent laboratory study on the effect of biochar addition to contaminated sediments showed that biochar is one to two orders of magnitude more effective at removing PCBs from soil pore water than natural organic matter, and may be effective at removing methylmercury but not total mercury (Gomez-Eyles et al., 2013). A laboratory column testing study to determine treatment effectiveness of 10 media mixtures showed that a mixture of 70% sand/20% coconut coir/10% biochar was one of the top performers and cheaper than similarly effective mixtures using activated carbon (Kitsap County, 2015). Liu et al (2016) tested 36 different biochars for their potential to remove mercury from aqueous solution and found that concentrations of total mercury decreased by >90% for biochars produced at >600°C but about 40–90% for biochars produced at 300°C.

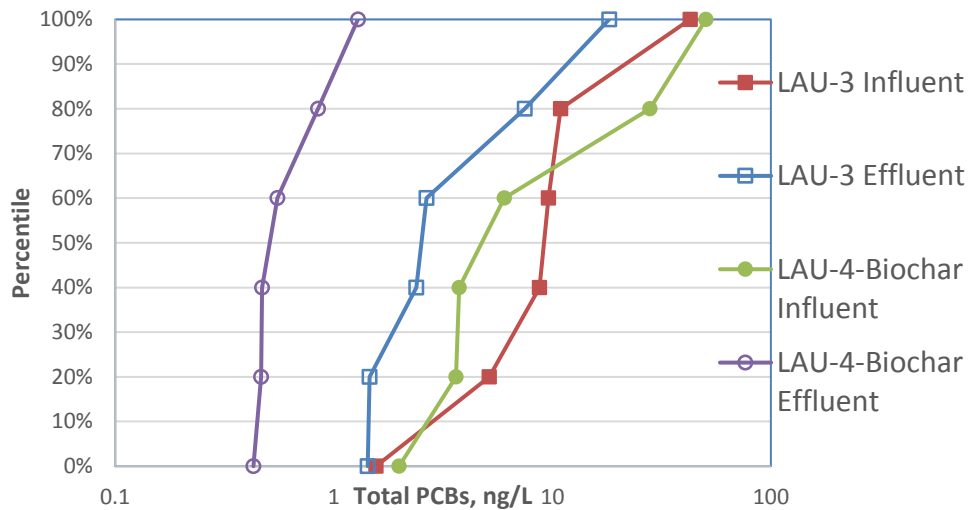

Figure 2.1 Cumulative Frequency Distribution of Total PCBs Influent Concentrations for Bioretention Media with and without Biochar

Monitoring of two bioretention cells at the Richmond PG&E Substation 1st and Cutting pilot site showed greater PCB removal for a biochar-amended BSM than that for standard BSM.

However, to date sampling has been limited to one test site and one biochar amendment, and the operational life of the amended media is unknown. **Besides the CW4CB study, there are no published literature studies on field PCB and mercury removal for biochars. Additional field testing can confirm the effectiveness of bioretention implementation in more typical conditions, and laboratory testing is recommended as an initial screening to help identify potential biochars for field testing.** Laboratory testing using actual stormwater from the Bay Area can be a cost-effective screening tool to identify biochar media that are effective for PCB removal, do not exacerbate mercury problems or even improve mercury removal, and meet operational requirements, including an initial maximum infiltration rate of 12 in/h and a minimum long-term infiltration capacity of 5 in/h.

3. Study Goals

The goals of this study identified from the problem statements are as follows:

1. Quantify annual PCB and mercury load removals during maintenance (cleanout) of HDS units
2. Identify biochar media amendments that improve PCB and mercury load removal by bioretention BMPs

To reach these goals, the following management questions are prioritized as primary or secondary management questions.

3.1 Primary Management Questions

A properly conceived study will address the study goals in a manner that supports planning for future management actions or evaluating the effectiveness or impacts of existing management actions. The resulting primary management questions focus on performance and are:

1. What are the average annual PCB and mercury loads captured by existing HDS units in Bay Area urban watersheds?
2. Are there readily available biochar-amended BSM that provide significantly better PCB and mercury load reductions than standard BSM and meet MRP infiltration rate requirements?

The MRP infiltration rate requirements are described in Provision C.3.c of the MRP (SFBRWQCB, 2015). This provision states the following: “Biotreatment (or bioretention) systems shall be designed to have a surface area no smaller than what is required to accommodate a 5 inches/hour stormwater runoff surface loading rate, infiltrate runoff through biotreatment soil media at a minimum of 5 inches per hour, and maximize infiltration to the native soil during the life of the Regulated Project. In addition to the 5 inches/hour MRP requirement, for non-standard BSM the recently updated BASMAA specification requires “certification from an accredited geotechnical testing laboratory that the bioretention soil has an infiltration rate between 5 and 12 inches per hour” (BASMAA, 2016a).

3.2 Secondary Management Questions

Secondary management questions are helpful, but they are not critical to the usefulness of the study. Study scope, budget, and schedule constraints limit the extent to which they can be addressed. Possible secondary management questions include the following:

HDS

1. How does sizing of HDS units affect annual PCB and mercury loads captured in HDS sediment?
2. Do design differences between HDS units (e.g., single vs multiple chambers) result in significant differences in pollutant capture?
3. How does the frequency of cleanout of HDS units affect load capture?

4. If present, does washout of HDS sediment depend on remaining sediment volume capacity?
5. Are there significant concentrations of PCBs in the pore (interstitial) water of HDS sediment?
6. Are PCBs and mercury removal correlated to removal of better-studied surrogate constituents, such as TSS?
7. Is there evidence of increased methylation within HDS sediment chambers?

Enhanced Bioretention

1. How does biochar performance vary with feedstock?
2. How does biochar performance vary with manufacturing method?
3. Should the biochar be mixed with the BSM or provided as a separate layer below the standard BSM?
4. Does biochar have leaching issues or require conditioning before use?
5. How long does the improved performance of biochar-amended BSM last?
6. Does the promising media increase methylation of mercury?
7. What is the expected increase in BSM costs due to inclusion of media amendment?
8. Does knowledge of the association of PCBs and mercury to specific particle sizes improve understanding of performance?
9. Is mass removal comparable to that expected from a conceptual understanding of removal mechanisms?

The above secondary management questions are provided as examples, and the questions answered will depend on budget, schedule, and actual data collected.

3.3 Level of Confidence

The level of confidence in the answers to the above management questions depends on sample representativeness and size. Samples are considered representative if they are derived from sites or test conditions that are representative of the watershed or treatment being considered. A power analysis can be used after monitoring commences or at the end of a study to determine if sample size is sufficient to draw statistically valid conclusions at a pre-selected level of confidence. Power analysis can also be used prior to study commencement, but its usefulness in estimating sample size requirements may be limited by lack of knowledge of variability in the biochar-amended BSM data to be collected.

Level of confidence can also be assessed in terms of consistency of treatment (e.g., a particular biochar consistently shows better removals than other biochars for a variety of stormwaters), which can be assessed with non-parametric approaches such as a sign-rank test.

Data analysis approaches are discussed in Section 8.5.

4. Study Design Options

An overview of the available study designs is presented here to understand the methods, value, and constraints of each design. This information is helpful in identifying which study designs are appropriate for the various management questions. To answer the primary management questions, the mass of pollutants captured must be quantified. This is accomplished by monitoring pollutant input and export for each HDS unit or media option, or directly quantifying captured pollutant. For example, the typical input and output pathways for a stormwater treatment measure (i.e., BMP) are illustrated in **Error! Reference source not found.4.1**. This overview describes how data are collected and how they are used to answer the primary study questions.

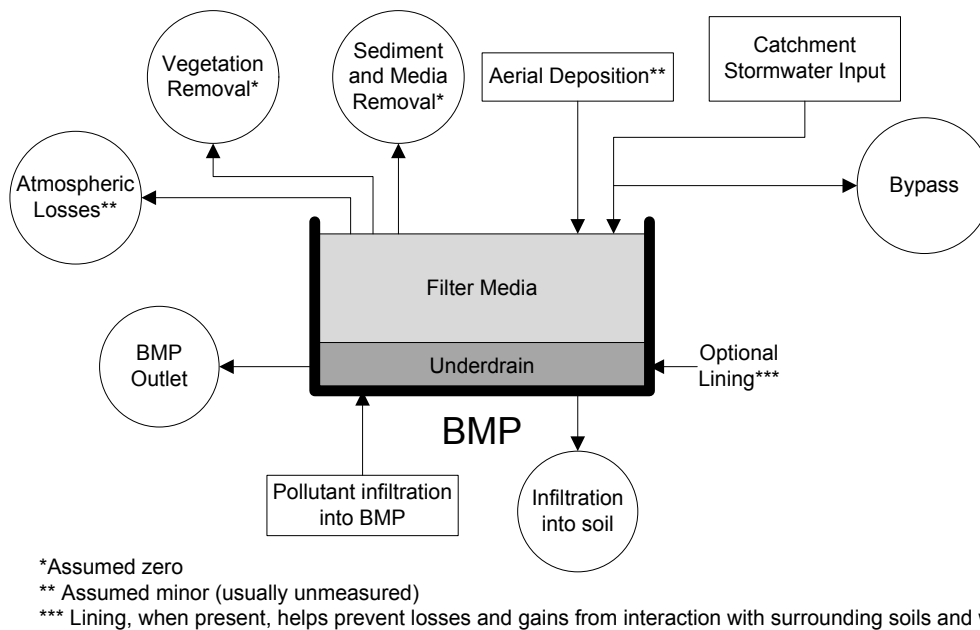

Figure 4.1 Typical BMP system and pollutant pathways

The study designs discussed here address major inputs and losses, but not all. Selection of study design is based on the management questions, the type of BMP(s), the study constraints, and the current and historic conditions of the study area. Each type of study has associated strengths and weaknesses as described below:

- **Influent-effluent monitoring**
 Influent and effluent monitoring tests water going into and discharging from a selected BMP or treatment option for a particular storm event. This approach is typically used to assess BMP effectiveness. An advantage of this approach is its ability to discern differences in limited data sets. A weakness of this approach is that measured load reductions may not be representative of true load reductions if there is infiltration to the native soil, baseflow entering the BMP, or bypass flows that are not monitored

- Sediment sampling
Sediment sampling occurs within the BMP or treatment option and is used to estimate cumulative load removed over several storms. Sediment sampling can occur in dry periods.
- Before-after monitoring
Before-after monitoring occurs at the same location. In the before-after approach, data are collected at some location, a change is made (i.e., a BMP is implemented or modified), and additional data are then collected at the same location. This introduces variability because in field monitoring the storms monitored before BMP implementation may not have the same characteristics as those after implementation.
- Paired watershed monitoring
Paired watershed attempts to characterize two watersheds that are as similar as possible, except one has BMP treatment (e.g., an HDS unit). The paired watershed approach is typically used when monitoring the influent of the BMP is infeasible. While the storms monitored are the same, inevitable differences in the watersheds often lead to unexplainable variability.

Paired watershed monitoring is not discussed further because it is not applicable to this study. The scope of work does not require influent monitoring at field sites or monitoring of paired sites without BMPs.

Volume measurement is critical to estimating load removal efficiency for BMPs that have volume losses. Volumes can be measured at influent, effluent, and bypass locations and within the BMP for individual storms or over a longer period.

The following subsections provide more detail on each monitoring approach.

4.1 Influent-Effluent Monitoring

Comparison of influent and effluent water quality and load is the method most often used in studies of treatment BMPs. This method is used to estimate the pollutant removal capability of field devices such as individual BMPs or a series of in-line BMPs (i.e., a treatment train) or laboratory treatment systems such as filter media columns. This type of study results in paired samples. Paired samples are beneficial because fewer samples are needed to show statistically significant levels of pollutant reduction compared to unpaired samples. This can result in substantial cost savings for sample collection and sample analysis.

Comparison of performance among BMPs may not be possible if there are only a limited number of locations because of different influent qualities. This is illustrated in **Error! Reference source not found.** for two non-overlapping BMP data sets, which show confidence intervals for effluent estimates (vertical dashed and dotted lines with arrows) expand as the distance between the hypothetical influent x-value and the mean x-value of the data increases. Although the effluent estimates at a common influent concentration (solid black square and diamond) may reflect true effluent qualities, confidence in these predictions is low because of this extrapolation and the performance of the two BMPs may not be statistically distinguishable. A better study design is one that selects sites with similar influent

characteristics or ensures collection of a sufficient number of samples at or close to the common influent level.

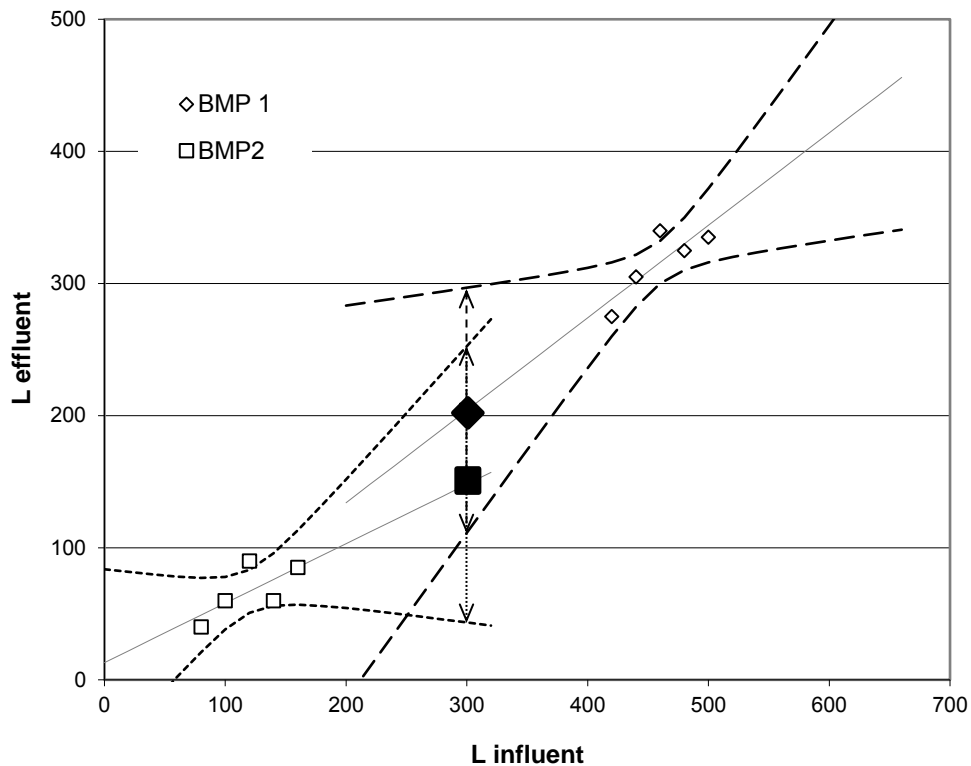

Figure 4.2 Comparison of two hypothetical non-overlapping BMP regressions

4.2 Sediment Sampling

Sediment sampling involves taking samples of actual sediment captured in a BMP in lieu of influent and effluent monitoring. Analysis of the accumulated sediment can provide estimates of the total mass of conservative pollutants removed¹. An advantage of sediment sampling is reduced cost because expensive storm event sampling is not required. Another advantage is that the measure of pollutants is direct and it is not possible to obtain negative results as in the case of sampling highly variable influent/effluent.

There are a number of limitations to sediment sampling. Annual sediment sampling during a maintenance interval generates fewer data points than influent-effluent sampling throughout a storm season, so comparisons among BMP factors (design, loading, etc.) may require a greater number of monitoring sites. Another limitation is that influent monitoring data are not available to describe how the mass removal estimates may be sensitive to influent loading, and influent monitoring may be required in addition to sediment sampling to

¹ In the context of sediment sampling, “conservative pollutants” are those that are not substantially lost to volatilization or plant uptake in between periods of sediment analysis. Sediment analysis underestimates performance where volatilization or plant uptake is substantial.

characterize pollutant loading. This limitation is addressed in this study during the data analysis by using model estimates of stormwater flows and pollutant loads from each HDS unit catchment to provide estimates of the influent and associated percent removals achieved.

Another limitation of sediment sampling is the potential error resulting in non-homogeneous pollutant distribution within the sediment. Compositing multiple samples will better characterize the sediment, much as the collection of several aliquots throughout a stormwater runoff event can better represent the total volume of water. Mixing the removed sediment before compositing can provide samples that are more homogeneous.

Consequently, the effectiveness of sediment sampling depends on the type of BMP. HDS are the best candidates for sediment sampling. The sumps are cleaned and empty at the start of the study, and the entire mass of retained sediment is removed at each maintenance event (sump cleanout). Conversely, bioretention has background sediment (planting media) that obscure pollutant accumulation. Since pollutants tend to accumulate on the surface of media (typically within the first few inches), surface sediments should be targeted when sampling these systems. Coring these systems and compositing the core sediments will most likely result in further dilution of the PCBs retained in the media, making quantification more difficult. For all systems, larger pieces of litter and vegetation may be difficult to include in the analysis. A conservative approach is to exclude larger material and assume these have little association with PCBs.

4.3 Before-After Monitoring

Pollutant removal can also be estimated by monitoring discharge quality for treatment devices before and after installation. This may be attractive for green street projects that have multiple BMPs with multiple influent and effluent locations. Monitoring all of these individual systems is almost impossible because of space constraints. Note that since the data from before/after implementation are unpaired, variability is expected to be larger and the number of samples required to show significant removal much higher than for paired samples.

Before-after monitoring is also applicable to laboratory test systems in which water quality is measured before and after a change is made. For example, the rate of adsorption or the adsorptive capacity of media can be determined by measuring the water quality before and after addition of a known quantity of media.

5. Primary Data Objectives

The study design options discussed previously are matched to the primary management questions. The primary management questions require two data objectives: determine annual mass captured by HDS units and load removal by biochar-amended BSM. The primary management questions are:

1. What are the **annual PCB and mercury loads captured** by existing HDS units in Bay Area urban watersheds?
2. Are there readily available biochar-amended BSM that provide significantly better **PCB and mercury load reductions** than standard BSM and meet MRP infiltration rate requirements?

Monitoring to address the first management question should at minimum provide the average annual PCB and mercury loads captured by HDS units.

5.1 Data Objective 1: Annual Loads Captured by HDS Units

Determined by influent-effluent monitoring for individual storm events over one or more seasons or filter media/sediment sampling at end of each season.

Options:

- ❖ Influent-effluent monitoring. Requires monitoring of as many storms as possible over a season and flow measurement in addition to water quality sampling. Flow measurement is a critical component for estimating stormwater volumes treated, retained, and bypassed, and is often associated with additional measurements such as water depth within a BMP to estimate bypass and retention.
- ❖ Filter media/sediment sampling. Requires sampling at end of season but does not require influent/effluent water quality or flow measurement. Sediment sampling has a high value for estimating annual mass removal because a single composite sample of retained sediment over a season can yield an estimate of load removal for the constituents analyzed. However, influent characterization would also help explain mass removal performance. This method is most appropriate when applied to HDS systems because they can isolate retained sediment.

5.2 Data Objective 2: Loads Reduced by Biochar-Amended BSM

Determined by influent-effluent monitoring or filter media/sediment sampling for individual events until sufficient data are available for statistical analysis.

Options:

- ❖ Influent-effluent monitoring. Requires monitoring of multiple individual events and flow measurement in addition to water quality sampling. Accurate flow measurement in BMPs is difficult because flows can vary an order of magnitude during individual events and measurements may be required at multiple locations within a device because of bypass, infiltration etc. (see Figure 4.2). This complexity introduces a great degree of variability in the monitored data that can substantially increase the number of data points required to show statistically significant load removals, particularly for BMPs such as HDS units that

show relatively small differences between influent and effluent load reductions. This option is most appropriate for testing filter media, for example in laboratory experiments, in which accurate flow measurements are possible and sampling of accumulated sediment is infeasible.

- ❖ Filter media/sediment sampling. Requires sampling after individual events but does not require influent/effluent water quality or flow measurement. This method is not feasible for filter media because the retained sediment cannot be isolated from the filter media.

6. BMP Processes and Key Study Variables

The treatment mechanisms that occur in a BMP help inform selection and control of the study variables. These treatment mechanisms, also called *unit processes*, may include physical, chemical, or biological processes. The primary physical, chemical, and biological processes that are responsible for removing contaminants include the following:

- Sedimentation – The physical process by which suspended solids and other particulate matter are removed by gravity settling. Sedimentation is highly sensitive to many factors, including size of BMP, flow rate/regime, particle size, and particle concentration, and it does not remove dissolved contaminants. Treated water quality is less consistent compared to other mechanisms due to high dependence on flow regime, particle characteristics, and scour potential.
- Flocculation – Flocculation is a process by which colloidal size particles come out of suspension in the form of larger flocs either spontaneously or due to the addition of a flocculating agent. The process of sedimentation can physically remove flocculated particles.
- Filtration – The physical process by which suspended solids and other particulate matter are removed from water by passage through layers of porous media. Filtration provides physical screening of particles and trapping of particles within the porous media. Filtration depends on a number of factors, including hydraulic loading and head, media type and physical properties (composition, media depth, grain size, permeability), and water quality (proportion of dissolved contaminants, particle size, particle size distribution). Compared to sedimentation, filtration provides a more consistent treated quality over a wider range of contaminant concentrations.
- Infiltration – The physical process by which water percolates into underlying soils. Infiltration is similar to filtration except it results in overall volume reduction.
- Screening – The physical process by which suspended solids and other particulate matter are removed by means of a screen. Unlike filtration, screening is used to occlude and remove relatively larger particles and provide little or no removal for particles smaller than the screen opening size and for dissolved contaminants.
- Sorption – The processes of absorption and adsorption occur when water enters a permeable material and contaminants are brought into contact with the surfaces of substrate media, plant roots, and sediments, resulting in short-term retention or long-term immobilization of contaminants. The effectiveness of sorptive processes depends on many factors, including the properties of the water (contaminant concentration, particle concentration, organic matter, proportion of dissolved contaminants, particle size, pH, particle size and charge), media type (surface charge, absorptive capacity), and contact time.

- Chemical Precipitation – The conversion of contaminants in the influent stream, through contact with the substrate or root zone, to an insoluble solid form that settles out. Consistent performance often depends on controlling other parameters such as pH.
- Aerobic/Anaerobic Biodegradation – The metabolic processes of microorganisms, which play a significant role in removing organic compounds and nitrogen in filters.
- Phytoremediation – The uptake, accumulation, and transpiration of organic and inorganic contaminants, especially nutrients, by plants.

The relative importance of individual treatment mechanisms depend to a large extent on the chemical and physical properties of the contaminant(s) to be removed i.e. the influent quality. The two contaminants of interest in this study are PCBs and mercury. PCBs are relatively inert hydrophobic compounds that have very limited solubility and a strong affinity for organic matter. They are often associated with fine and medium-grained particles in stormwater runoff, making them subject to removal through gravitational settling or filtering through sand, soils, media or vegetation. Most of the mercury in water, soil, and sediments is in the form of inorganic mercury salts and organic forms of mercury such as methylmercury that are strongly adsorbed to organic matter (e.g., humic materials). In general, mercury is most strongly associated with fine particles while PCBs are generally associated with relatively larger and/or heavier particles. It is therefore expected that sedimentation, flocculation, and related processes will be less effective for mercury removal than for removal of PCBs (Yee and McKee, 2010).

The following subsections provide a brief description of the BMP types being evaluated in this study, the unit processes involved in each, and key variables that indicate possible data collection approaches. The final selection of the quantity and type of data to collect is presented in the “Optimized Study Design” section.

6.1 HDS Units

Hydrodynamic separators rely on sedimentation and screening as the primary removal mechanism for sediment and particulate pollutants. Treatment performance is highly dependent on the following:

- Influent quality (contaminant concentration, proportion of dissolved contaminants, particle size, particle size distribution, and particle density)
- BMP design and hydraulic loading/flow regime (size of unit versus catchment area)
- Operational factors (remaining sediment capacity)

HDS effluent quality is highly variable, particularly for contaminants such as mercury that are associated with fine particles that are not as effectively removed in HDS. These devices are expected to require a relatively large number of influent-effluent samples to demonstrate statistically significant reductions in pollutant concentrations. Therefore, analysis of retained sediment is an appropriate alternative to influent-effluent sampling for determining pollutant mass captured. Sediment can be analyzed when the device is cleaned.

6.2 Bioretention

Bioretention is a slow-rate filter bed system. It is planted with macrophytes (typically shrubs and smaller non-woody vegetation). The major sediment removal mechanism is physical filtration through the planting media. When retention time is sufficient, dissolved constituents can be removed by sorption to plant roots in the planting media, which typically contains clays and organics to enhance sorption. Treatment performance is highly dependent on the following variables:

- Influent quality (contaminant concentration, particle concentration, organic matter, proportion of dissolved contaminants, particle size, particle size distribution)
- BMP design and hydraulic loading rate/head (size of the unit in relation to catchment area and storm character)
- Media type and properties (composition, grain size, grain size distribution, adsorptive properties, and hydraulic conductivity)
- Volume reduction by infiltration
- Operational factors (surface clogging, short-circuiting)

The effluent quality from bioretention and enhanced bioretention is expected to be consistently higher than for sedimentation-type BMPs. These devices are expected to require a relatively fewer number of samples than HDS units to demonstrate statistically significant reduction because of better treatment of fine particles and dissolved contaminants.

It is important to note that laboratory and not field bioretention systems are of interest in this study. These laboratory systems, essentially cylindrical columns filled with the media being tested, attempt to simulate most, but not all, of the chemical, biological, and physical processes that occur in field devices. For example, volume reductions due to infiltration are not simulated in laboratory column experiments. The advantages of using media columns as proxies for field devices include improved control over operation, monitoring, and sample collection in ways that would be impractical in the field. This improved control makes it possible to test a large number of potential media and identify the most promising for future field testing.

7. Monitoring and Sampling Options

Key variables that affect water quality and sediment quality data are identified from knowledge of treatment processes. The following lists the process variables identified through knowledge of the treatment processes:

- Influent quality (contaminant concentration, particle concentration, organic matter, proportion of dissolved contaminants, particle size, particle size distribution, particle density)
- BMP design and hydraulic loading (flow rate, hydraulic head, flow regime)
- Media type and properties (composition, grain size, grain size distribution, adsorptive properties, and hydraulic conductivity)
- Operational factors (surface clogging, short-circuiting, remaining sediment capacity)

Some of the above variables can be controlled and others are measured to determine their effect on water quality and sediment quality. Inevitably, some variables will be beyond the control of the study but their expected impact should be considered based on theory, past experience, models, or observations from other studies.

7.1 HDS Units

7.1.1 Influent Quality

The location of the BMP can greatly affect influent water quality such as pollutant concentrations and particle characteristics because land use and land cover affect sediment mobilization and pollutant concentrations within the sediments. Land use is often used as an indicator of pollutant loading. The land uses of the areas of interest include industrial, commercial/mixed use, roads/rail, institutional, and residential. Because of past use of PCB and past PCB and mercury handling practices, age of the land use is also important, with generally higher concentrations from older industrial, commercial, and transportation areas, and lower concentrations from newer residential areas. However, PCB analysis by the San Francisco Estuary Institute (SFEI) showed that PCB concentration patterns were patchy within larger urban watersheds with higher concentrations. This finding indicates that mass reductions of PCBs may require site-specific sampling of influent loads or site-specific quantification of mass removed. Mercury data suggest areas with higher mercury concentrations are not as pronounced although generally where there is PCB contamination there is also high to moderate Hg contamination (Yee and McKee, 2010).

Since HDSs are primarily installed for trash capture, their distribution within the study area is assumed to be random. However, the primary interest is in watersheds with relatively high pollutant loads that are most likely to result in significant removal in HDSs (e.g., the Leo Avenue watershed). Land use or land use based pollutant yields can be used to represent average influent water quality when influent monitoring is not conducted.

Figure 7.1 shows the land use based PCB and mercury loadings for key designated land use types. It can be seen that unit PCB loading from watersheds with higher PCB concentrations and mercury loading from old industrial watersheds are substantially higher than the other land uses. Assuming particle size, particle size distribution, and other stormwater characteristics are similar for the different land uses, HDSs in higher concentration watersheds or old industrial watersheds are expected to capture much higher pollutant loads than those in other watersheds.

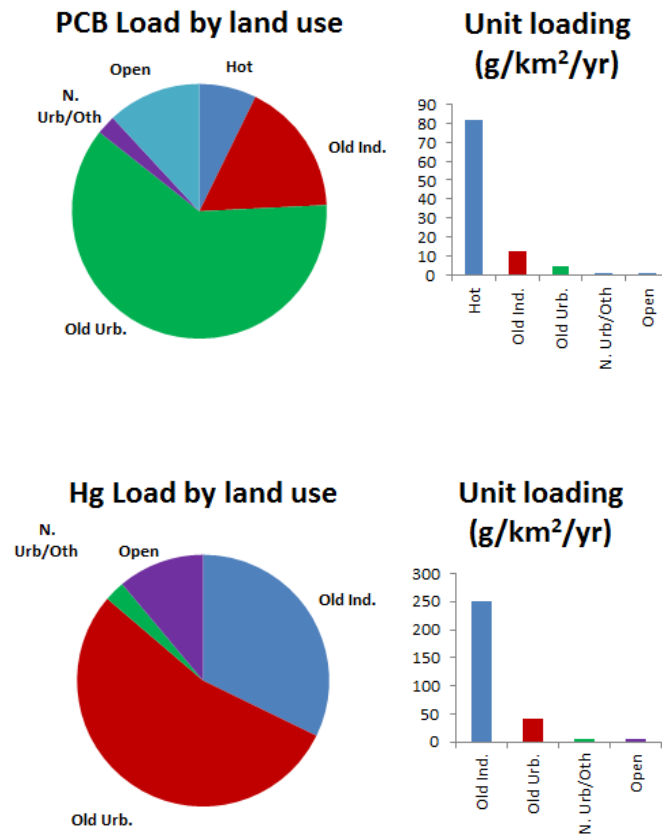

Figure 7.1 Land Use based PCB and Mercury Loading based on BASMAA Integrated Monitoring Reports (SFEI, 2015)

A preliminary land use based study design could categorize HDS sites as show in Table 7.1.

Table 7.1 HDS Sampling Design based on Watershed Land Use

Land Use	HDS Samples
Higher Concentration	X, X, X ¹
Old Industrial	X, X, X ¹
Old Urban	X, X, X ¹

1 – “X” represents a sample from a selected HDS unit in the specified land use category.

The above design is appropriate if HDS units can be categorized easily into one of the three land use categories. A review of the land uses within HDS watersheds indicates that most HDS units are in predominantly old urban watersheds, and it is unclear how many HDSs are within areas with higher PCB concentrations (Table 7.2).

Table 7.2 Percent of Land Use in HDS Watershed Areas

(Based on FY 2015-16 Co-permittee Annual Reports, Section 10 - Trash Load Reduction. Source: Chris Sommers Personal Communication)

HDS Catchment ID	New Urban	Old Industrial	Old Urban	Open Space	Other
287; Sonora Ave		16	84	1	
27A	15	50	34	2	
996; Parkmoor Ave		1	98	1	
1084; Oswego		0	89	0	10
600; Edwards Ave		33	39	28	
611; Balfour		14	55	30	
1082; Melody/33rd		0	97	3	
612; Lewis			93	7	
604; Sunset			96		4
1012; Blossom Hill/Shadowcrest			100	0	
1083; Lucretia		0	98	1	1
1002; Selma Olinder		10	86	5	
995; Dupont St.		9	91	0	
9-A; 73rd Ave and International Blvd		0	94	6	
475; 7th		68	29	3	
509; Coyote	22		77	1	
47			99	1	
8-A; Alameda Ave near Fruitvale		40	57	4	
575; Bulldog		6	93	1	
601; W. Virginia		7	90	3	
1504; Phelps			100	0	
390; Remillard		4	87	10	
Tennyson at Ward Creek		1	97	2	
W Meadow Dr		2	97	1	
Leland and Fair Oaks		1	99		
Ward and Edith			100	0	
5-D; 22nd and Valley		1	99	0	
8-C; High St @ Alameda Bridge		67	32	0	
5-G; Perkins & Bellvue (Nature Center)			100		
999; William		0	95	5	
Main St and Hwy 1			85	15	
Central Expy at Fair Oaks		11	89	0	
393; Wool Creek		18	78	4	
5-C; 27 St & Valdez Ave		2	98		
998; Pierce		1	96	3	
Maple and Ebensburg			98	2	
Ventura Ave			99	1	
Golden Gate and St Patrick			100	0	
5-A; Euclid Ave @ Grand Ave			100		
5-H; Lake Merritt (SD Outfall 11)			100		
5-B; Staten Ave & Bellvue			100		
Central Expy at De la Cruz		33	67		
5-I; Lake Merritt (SD Outfall 26)			100		
Mathilda overpass project CDS2		0	100		
Mathilda overpass project CDS1		10	84	7	

Given the few sites in categories other than old urban, an alternative study design based on mixed land uses may be more appropriate (Table 7.3).

Table 7.3 HDS Sampling Design based on Predominant Land Use

Predominant Land Use	HDS Samples
Higher Concentration/Old Industrial	X, X, X ¹
Old Urban/Old Industrial	X, X, X ¹
New Urban/Old Urban	X, X, X ¹

1 – “X” represents a sample from a selected HDS unit in the specified land use category.

The sampling design in Table 7.3 assumes that at least three HDS units are available for sampling in each PCB land use category. The sampling design may need to be modified further if there are an insufficient number of units available for sampling. For example, any site with more than 30% old industrial may be considered especially if it is a mixed zoned watershed (with industrial, commercial, residential and transportation land uses). The range of values in each land use category can be determined upon review of the most recent information. The design in Table 7.3 assumes that the characteristics of the runoff (e.g., particle sizes) are similar for the different land uses and only the yield is different.

Only sediment sampling is proposed for HDS. Since HDS influent-effluent monitoring is not required, variables such as proportion of dissolved contaminants, particle size, particle size distribution, and particle density are not measured or controlled, but their effect on influent quality and treatment is accounted for by randomly selecting HDSs within each land use category.

7.1.2 BMP Design and Hydraulic Loading

BMP design and hydraulic loading, which depends on the size of the BMP, can have a substantial impact on effluent water quality and the quantity of sediment retained in a BMP. Consequently, a full range of BMP designs and sizes are of interest. Properly sized, BMPs infrequently exceed their design capacity. However, BMPs are not always sized to standard specification, especially in retrofit environments in which typical hydraulic loading is much higher due to space constraints.

HDS units are typically proprietary and designs and sizing vary widely. Sediment capture may vary because of design differences such as number of chambers and design of overflow weirs and baffles, as well as different sizing criteria that can greatly affect both hydraulic loading and flow regime. The purpose of the study is to characterize sediment in HDS units in the study area. Since BMP design and sizing are important factors affecting HDS performance, it is necessary to include a range of HDS units in the study design and not just randomly select HDS units. A randomized blocked study design is therefore considered more appropriate than a completely random one that may result in an insufficient number of HDS units of a certain size.

In a randomized design, one factor or variable is of primary interest (e.g., land use), but there are one or more other confounding variables that may affect the measured result but are not of primary interest (e.g., HDS design, HDS size). Blocking is used to remove the effects of one or more of the most important confounding variables and randomization within blocks is then used to reduce the effects of the remaining confounding variables. An appropriate sampling design could therefore be land use as the primary factor and HDS size as the blocking factor. Since the population of HDS units in the land use categories of interest is limited, only

two size blocks are used ($\leq 50^{\text{th}}$ percentile, $> 50^{\text{th}}$ percentile), and other variables such as design differences are accounted for by random selection within each block (Table 7.4).

Table 7.4 HDS Sampling Design based on Predominant Land Use and HDS Size

Predominant Land Use	HDS Size	
	$\leq 50^{\text{th}}$ percentile	$> 50^{\text{th}}$ percentile
Higher Concentration/Old Industrial	X, X, X ¹	X, X, X ¹
Old Urban/Old Industrial	X, X, X ¹	X, X, X ¹
New Urban/Old Urban	X, X, X ¹	X, X, X ¹

1 – “X” represents a sample from a selected HDS unit in the specified land use category.

For the sampling design in Table 7.4, an HDS size factor is required to differentiate the two types of sizes that are of interest. In controlled field study of 4 different proprietary HDS units and laboratory testing of 2 other units, Wilson et al. (2009) developed a *performance function* (treatment factor) that reasonably predicted the removal efficiency of a given hydrodynamic separator. The performance function explained particle removal efficiency in terms of a Péclet number, P_e , which accounts for particle settling and turbulent diffusion. In the following equation, V_s is the particle settling velocity, h is the settling depth in the device, d is the device diameter, and Q is the flow through the device:

$$P_e = \frac{V_s h d}{Q}$$

The above Péclet number (Wilson et al’s performance function) can be used in the sampling design as the HDS size factor. For grouping the available HDS units into the two blocks, information is required on the particle diameter and design parameters for each device (settling depth, diameter, and design flow). Particle diameter can be assumed to be 75 μm , which is the critical size used for partitioning PCB fractions in Yee and McKee (2010), and is also approximately the size separating silt and fine sand size particles. The design flow can be calculated from knowledge of the drainage area to the device and a standard design storm. Note that the design flow should not be based on manufacturer guidance because different manufacturers use different sizing criteria and device sizing may not always follow manufacturer guidance.

The final sampling design may need revision depending on the monitoring approach, availability of HDSs, information on watershed land use and sizing, and the level of participation from municipalities.

7.1.3 Operation and Maintenance

Maintenance frequency can greatly impact BMP performance. For sedimentation BMPs such as HDS, sediment levels may exceed the sediment capacity of the BMP, decreasing the volume for sedimentation and increasing scour.

Operation and maintenance (e.g., cleanout frequency) are not of direct interest in this study and their effect on treatment is not being tested. However, these are confounding variables that need to be excluded. In the HDS sediment sampling design, HDS units that are considered at capacity or will reach capacity during the study should be excluded from the population of interest. Field observations are required to make this determination (e.g., whether the screen is blocked). These units can be cleaned out and sampled in a subsequent year. For each selected HDS unit, maintenance schedules (past and current) will need to be reviewed to determine the time period over which sediment accumulated.

7.2 Enhanced Bioretention

7.2.1 Influent Quality

The purpose of the laboratory testing is to screen alternative biochar-amended BSM and identify the most promising for further field testing. The laboratory testing requires influent-effluent monitoring. Influent water characteristics can vary depending on the source of the test water. PCB and mercury loading is largely a result of historic activities that result in accumulation in sediments of pervious areas. Mobilization of these sediments may require exceeding site-specific intensity and volume thresholds. Storm intensity is critical to detach and mobilize particles and storm volume must exceed any depression storage within the pervious areas. However, the precise effect of storm intensity and volume on the mobilization of PCB-contaminated and mercury-contaminated sediments has not been established. Influent water characteristics also depend greatly on drainage area characteristics including traffic and industrial and commercial activity.

Since the purpose of the laboratory study is to screen alternative biochar-amended BSM that can be used throughout the Bay Area, collection and use of stormwater from one or more representative watersheds is preferred. A preliminary review of available Bay Area stormwater runoff monitoring data from 27 sites (Table 7 of SFEI 2015) suggests median PCB concentration is about 9 ng/L. Therefore, one or more previously monitored watersheds with mean PCB concentrations well above 10 ng/L may be appropriate for collection of stormwater for the laboratory testing. Since the relative treatment performance of the various media at even lower concentrations may be different, additional tests with diluted stormwater may be required to confirm study results.

Storms from the representative watershed should be targeted randomly without bias, thereby accounting for the effects of storm intensity and ensuring variability in contaminant concentration, proportion of dissolved contaminants, particle size, particle size distribution, and particle density. To achieve this, minimal mobilization criteria should be used to ensure predicted storm intensity and runoff volume are likely to yield the desired volume.

7.2.2 BMP Design and Hydraulic Loading

The design variables in the enhanced bioretention testing laboratory study include media type, media depth, and media configuration. Media type is a key variable that is discussed further below. Testing the effect of different media depths or media configurations is not a research objective of the laboratory study, so these can be fixed for all experiments. Typical bioretention media depth in the Bay Area is 18 inches, so all column experiments should use 18 inches of BSM. In the Richmond PG&E Substation 1st and Cutting enhanced BSM testing, the biochar was not installed as a separate layer but was instead mixed with the standard BSM. It is unclear how treatment is affected by these two media configurations, but for consistency with previous field work the biochar and standard BSM should be mixed.

Hydraulic loading is a controlled variable that can be kept constant for all columns. Since the laboratory study is attempting to replicate field bioretention, the hydraulic loading can be the design loading for bioretention. Bioretention designs in the Bay Area typically have a maximum ponding depth of 6 inches, so a loading of 6 inches could be used for the column tests. There are two options for loading the columns: pump and manual. Peristaltic pumps are ideal for controlled loading, but in this study manual loading (batch loading) is more appropriate because of the potential for PCBs and mercury to stick to tubing, pump parts, etc. For manual loading, up to 10 inches of stormwater may be needed each time to ensure sufficient sample volume.

7.2.3 Media Type and Properties

Media type and properties have a substantial effect on the treatment performance of filtration devices. This group of variables include composition, grain size, grain size distribution, adsorptive properties such as surface area, and hydraulic conductivity. Media composition is a primary variable that accounts for differences in the biochars used and the proportion of each biochar in the amended BSM mix. The other variables (grain size, grain size distribution, adsorptive properties, and hydraulic conductivity) are not of direct interest in this study and are assumed to vary randomly or are controlled through screening experiments that limit their variability.

Biochar is produced from nearly any biomass feedstock, such as crop residues (both field residues and processing residues such as nut shells, fruit pits, and bagasse); yard, food, and forestry wastes; animal manures, and solid waste. Biochar feedstock and production conditions can vary widely and significantly affect biochar properties and performance in different applications, making it difficult to compare performance results from one study to another (BASMAA, 2017a). A laboratory study that characterized the physical properties of six different waste wood derived biochars found particle sizes ranging from over 20mm to fine powder and surface areas ranging from 0.095 to 155.1 m²/g (Yargicoglu et al., 2015). The variability in biochar types and properties is expected to result in large variation in treatment efficiency and infiltration rates. Given the large number of potential biochars that could be tested and the need to meet an initial maximum 12 in/h infiltration rate and a minimum long-term infiltration rate of 5 in/h, a phased study design is appropriate. In such a phased study, promising readily available biochars are first identified through a review of the literature, and hydraulic screening experiments are performed on biochar-BSM media mixes to ensure infiltration rates are met

prior to performance testing. This approach is expected to be the most cost-effective because it reduces analytical costs.

There is little information on hydraulic properties of bioretention media amended with biochar, and it is not clear what percentage of the amended BSM should be biochar to maximize treatment benefit. Given the variable physical size of the biochar media, relatively fine biochars could result in a mix that does not meet the initial 12 in/h maximum infiltration rate or minimum 5 in/h long-term infiltration rate. Kitsap County (2015) tested a BSM mix containing 60% sand, 15% Compost, 15% Biochar, and 10% shredded bark, and found that the biochar mix had an infiltration rate of only 6.0 in/h. One conclusion of the study was that the reduction in infiltration rate with the biochar additive was most likely because of fines in the biochar. To overcome this, hydraulic screening experiments are required in which the infiltration rate for each media mix is measured prior to water quality testing to ensure that both the maximum and minimum rates are met. Initially, each biochar can be mixed with standard BSM at a rate of 25% biochar by volume (the same as that at the CW4CB Richmond PG&E Substation 1st and Cutting site). Hydraulic conductivity can be determined using the method stated in the BASMAA soil specification, method ASTM D2434, which requires measurement of water levels and drain times. If a mix does not meet the infiltration requirements, the percentage of biochar is adjusted and the new mix tested. Amended mixes that do not meet the infiltration rate requirements are removed from further consideration (i.e. the effect of hydraulic conductivity is controlled by screening).

The final phase of the laboratory study can be column testing to identify the most effective amended BSM mixes for field testing. An influent-effluent monitoring design is typically used in column testing and media effectiveness is assessed on a storm-to-storm basis with real stormwater collected in the Bay Area. Only media mixes that have passed the hydraulic screening should be tested. All media columns should be sufficiently large or replicated to account for or minimize the impact of variability in media installation and experimental technique. Standard BSM should be used as a control since the primary interest is to identify media mixes that perform significantly better than standard BSM. An example of the column sampling design for 5 new media mixes and one standard BSM control is shown in Table 7.5. The key variable of interest in the sampling design in Table 7.5 is the media mix (composition).

Table 7.5 Example Sampling Design for Laboratory Column Experiments

Biochar/BSM Mix	Column Samples
A Mix	X, X, X ¹
B Mix	X, X, X ¹
C Mix	X, X, X ¹
D Mix	X, X, X ¹
E Mix	X, X, X ¹
Control Mix	X, X, X ¹

1 – “X” represents an influent or effluent sample.

7.2.4 Operation and Maintenance Parameters

Operational life depends on the capacity to pass the minimum required stormwater flows. Like media life, operational life is important because it determines the frequency and cost of maintenance requirements. Maintenance frequency can greatly impact BMP performance, and lack of maintenance can lead to surface clogging and sediment clogging in the inlets which reduces treatment capacity and increases bypass and overflow. Operation and maintenance are not of direct interest in this study and their effect on treatment is not being tested. However, these are confounding variables that need to be excluded.

Media mixes that do not meet the maximum 12 in/h and minimum 5 in/h infiltration rates can be excluded by hydraulic screening experiments (discussed above). As well as meeting the maximum 12 in/h initial infiltration rate requirement, these screening experiments help ensure that the BSM mixes do not fail during the laboratory testing. However, operational performance in laboratory experiments is not expected to be representative of that in the field because of differences in influent quality, variability in loading, effects of vegetation, etc. Therefore, laboratory estimates of long term infiltration rate are of little use and field testing is required to confirm that selected media mixes meet the long-term minimum infiltration rate of 5 in/h. The laboratory testing, however, can provide relative comparisons of hydraulic performance that can be used to decide and screen out media mixes that are likely to hydraulically fail in the field.

7.3 Uncontrolled Variables and Study Assumptions

The following assumptions were adapted from the Caltrans PSGM (Caltrans, 2009):

- ❖ Site Assumptions
 - HDS sediment concentrations are representative of the land use within the watershed, i.e. there are no sources of sediment from adjoining watersheds, from illicit discharges, or from construction activities
 - HDS sediment or influent is not affected by base flow, groundwater, or saltwater intrusion
 - Differences in storm patterns throughout the Bay Area are not sufficient to change the HDS performance measurements
 - Water quality of stormwater collected for laboratory testing is representative of that observed in Bay Area urban watersheds
- ❖ BMP Operation Assumptions
 - Sampled HDS units operated as designed (e.g., no significant scouring)
 - Volatilization of pollutants is negligible
 - There is no short-circuiting of flows in laboratory column studies
- ❖ Media Selection Assumptions
 - The readily available biochars selected are representative of all biochars
 - Selected media do not leach contaminants and media conditioning (e.g., washing) is not required
- ❖ Monitoring Assumptions

- Data collected from a few sites over a relatively short time span will accurately represent sediment at all HDS sites over longer time frames
- There are minimal contaminant losses in collecting and transporting water for laboratory experiments
- Water quality of stormwater for laboratory tests does not change significantly during each test
- Stormwater loading of laboratory columns is representative of loading in the field
- Long-term infiltration performance of biochar mixes is to be tested in the field

8. Final Study Design

The study design is optimized to answer the primary management questions within the available budget. The design used prioritizes sampling of HDS units, but allocates sufficient funding for minimum sampling requirements for the laboratory media testing study. Monitoring that does not relate directly to the primary management questions is considered lower priority.

8.1 Statistical Testing & Sample Size

In a traditional test of a treatment, the null hypothesis is that there is no difference between the influent and effluent of a treatment (i.e., the treatment does not work). In the case of HDS sampling, influent-effluent sampling is not required, and interest is only in determining if HDS units remove PCBs and mercury and how the sediment concentrations and load removals vary for different land uses, and for different rainfall and stormwater flow characteristics. Statistical testing in the HDS study is therefore limited to testing if there is a difference in the concentrations and loads captured by HDS units in different watersheds. This testing will require sampling of a sufficient number of HDS units in each land use category associated with differing pollutant load yields.

In the laboratory study, influent-effluent sampling is required and traditional statistical tests can be used depending on sample size.

As well as traditional statistical testing, confidence in the conclusions can be established by comparing total PCB and mercury performance to that for other constituents that directly affect it (e.g., suspended solids, total organic carbon) or have similar chemistry (e.g., other organics). As stated previously, total PCB and mercury concentrations are expected to correlate to some extent with particulates and organics. Comparisons to other constituents are particularly useful for studies in which treatment is expected to be low and the corresponding sample size requirements very high.

Sample size requirements are smaller for paired sampling designs (i.e., influent and effluent sampling for the same storm event) than for independent sampling designs. Paired sampling is not possible for the HDS sampling study that has no influent-effluent monitoring, but is possible in the laboratory media testing study. Additionally, the number of samples required to show significant treatment are generally fewer for filtration-type BMPs than sedimentation-type BMPs because of their better and more consistent treatment.

8.2 Constituents for Sediment Analysis

Constituents selected for HDS sediment analysis must meet the data objectives discussed previously in “Primary Data Objectives”, and be consistent with Table 8.3 of the MRP (SFRWQCB, 2015). Sediment samples will be screened using a 2 mm screen prior to analysis. Table 8.1 lists the constituents for sediment quality analysis. Total organic carbon (TOC) is included because it is a MRP requirement and can be useful for normalizing PCBs data collected for the sediment.

The primary objective of sediment analysis is quantification of the mass of PCBs and mercury accumulating within HDS units. Consequently, PCBs and total mercury are analyzed

for all screened sediment samples. The secondary objective is to establish a relationship between total PCBs, mercury, and particle size. Correlating total PCBs and mercury to particle sizes will complement past studies and provide insight into the type of BMPs that are appropriate to achieve the most cost-effective mass removal.

Analysis of PCBs at the CW4CB Leo Avenue HDS showed that PCBs in the water above the sediment may be minor when compared to sediment-associated PCBs (BASMAA, 2017b). PCB concentrations in overlying water are expected to be low and sampling of this water is not included in this study design.

Table 8.1 Selected Constituents for HDS Sediment Monitoring

Constituent
TOC
Total Mercury ¹
PCBs (40 congeners) in Sediment
Particle Size Distribution
Bulk Density

¹ - Only total mercury analyzed. Methyl mercury is not relevant for SF Bay TMDL.

8.3 Constituents for Water Quality Analysis

Constituents for analysis of water samples must meet the data objectives discussed previously in “Primary Data Objectives”, and be consistent with Table 8.3 of the MRP (SFRWQCB, 2015). Table 8.2 lists the constituents for the laboratory media testing studies. The list of water quality constituents must provide data to address the primary management question to quantify total PCB and mercury reduction, so PCBs and total mercury are analyzed for all samples. Secondary management questions relate to understanding removal performance for total PCB and mercury.

In addition to PCBs and total mercury, the other constituents selected for influent and effluent analysis are SSC, turbidity, and TOC. SSC was selected because it more accurately characterizes larger size fractions within the water column, while turbidity was selected because it is an inexpensive and quick test to describe treatment efficiency where strong correlation to other pollutants has been established. As with the sediment analysis, TOC is included because it is a MRP requirement and can be useful for normalizing PCBs data collected for water samples.

Table 8.2 Selected Aqueous Constituents for Media Testing in Laboratory Columns

Constituent
SSC
Turbidity
TOC
Total Mercury ¹
PCBs (40 congeners) in Water

1 - Only total mercury analyzed. Methyl mercury is not relevant for SF Bay TMDL.

8.4 Budget and Schedule

The monitoring budget for the study is approximately \$200,000. A contingency of 10 percent of the water quality monitoring budget is recommended to account for unforeseen costs such as equipment failure. Another constraint is that all sampling will occur in one wet season.

8.5 Optimized Study Design

The optimized study designs are presented in Tables 8.3 and 8.4 for the HDS Monitoring and Enhanced Bioretention studies, respectively. Several iterations were analyzed and the study designs shown are based on best professional judgment to allocate the budget to the various data collection options.

The final design for the HDS monitoring study is based on selection and sampling of 9 HDS units in key land use areas. The number of units that can be sampled is limited because sampling is expected to be opportunistic as part of regular maintenance programs. Therefore, a simple design with 9 units is appropriate. The data analysis will evaluate the percent removal achieved for each HDS unit during the time period of interest (i.e., the time period between the date of the previous cleanout, and the current cleanout date for each HDS unit sampled) by incorporating modeled estimates of stormwater volumes and associated pollutant loads for each HDS unit catchment. Because HDS units are sized to treat stormwater runoff from storms of a given size and intensity, excess flows for storms exceeding the design capacity will bypass the unit and are not treated. Storm by storm analysis of rainfall data during the time period of interest will allow estimation of the total stormwater volume and pollutant load to the catchment during each storm, as well as the volume and pollutant load that bypassed the HDS unit and was not treated. This information will then be combined with the measured pollutant mass captured by each HDS unit to quantify the percent removal of PCBs and mercury from the total catchment flow, and the percent removal of PCBs and mercury from the treated flow. For each HDS unit sampled in the study, the total and treated pollutant mass removed will be calculated using the following equations.

$$(1) \text{ Total Pollutant Mass Removed (\%)} = \left[\frac{M_{\text{HDS-i}}}{M_{\text{Catchment-i}}} \right] \times 100\%$$

$$(2) \text{ Treated Pollutant Mass Removed (\%)} = \left[\frac{M_{\text{HDS-i}}}{(M_{\text{Catchment-i}} - M_B)} \right] \times 100\%$$

Where:

- $M_{\text{HDS-i}}$ the total POC mass captured in the sump of HDS Unit i over the time period of interest
- $M_{\text{Catchment-i}}$ the total POC mass discharged from Catchment-A (the catchment draining to HDS unit A) over the time period of interest
- M_{B} the total POC mass that bypassed HDS unit A over the time period of interest

The following inputs will be measured or modeled for the time period of interest for use in the equations above:

- Total PCBs and mercury mass captured by a given HDS unit. This is the mass measured in each HDS unit during this project.
- The total stormwater volume and associated PCBs and mercury load from the HDS unit catchment. This will be modeled on a storm by storm basis using available rainfall data, catchment runoff coefficients, and assumed pollutant stormwater concentrations.
- The stormwater volume and associated PCBs and mercury load that bypassed the HDS unit. The bypass volume (and associated pollutant load) during each storm (if any) will be calculated based on the design criteria for a given HDS unit.
- The total PCBs and mercury load treated by a given HDS unit. This will be determined by subtracting the bypass load (if any) from the total pollutant load for the catchment.

The corresponding design for the enhanced BSM study is based on testing of readily available biochars in hydraulic screening experiments followed by column testing of up to five promising BSM mixes as well as a standard BSM control mix. The final number of BSM mixes will depend on availability and media properties (e.g., expected hydraulic conductivity). The optimized designs will yield 33 data points for the key data objectives, 9 from the HDS monitoring study and 24 from the enhanced BSM media testing column study.

Table 8.3 HDS Monitoring Study Design

Primary Management Question(s)	What are the annual PCB and mercury loads captured by existing HDS units in Bay Area urban watersheds and the associated percent removal?												
Type of Study	Sediment monitoring; modeling stormwater volume and pollutant load												
Data Objective(s)	Annual PCB and mercury mass captured in HDS units and percent removal												
Description of Key Treatment Processes	Sedimentation, Flocculation & Screening <ul style="list-style-type: none"> Removal by gravity settling and physical screening of particulates Effectiveness depends on water quality, BMP design and hydraulic loading/flow regime, and operational factors 												
Key Variables	<ul style="list-style-type: none"> Sediment quality and quantity Influent quantity and quality (contaminant concentration,) BMP design and hydraulic loading/flow regime BMP maintenance (remaining sediment capacity) 												
Monitoring Needs	<p>Monitored variables: sediment quality, sediment mass</p> <p>Controlled variables: influent quality, BMP maintenance (remaining sediment capacity)</p> <p>Uncontrolled variables: HDS design, hydraulic loading, flow regime</p>												
Monitoring Approach	<p>Influent quantity and quality: based on rainfall/runoff characteristics and on land use pollutant yield (old urban, new urban, etc.)</p> <p>Hydraulic loading: base on HDS size (diameter and settling depth) and flow (design flow for known watershed size)</p> <p>BMP maintenance: base on remaining sump capacity</p>												
Sampling Design	<p>Sampling expected to be opportunistic as part of regular maintenance programs. Targeted predominant land uses for HDS selection and corresponding data generation:</p> <table border="1" style="margin-left: 40px;"> <thead> <tr> <th>Predominant Land Use</th> <th>HDS Samples</th> <th>No. Samples (Total 9)</th> </tr> </thead> <tbody> <tr> <td>Higher Concentration/Old Industrial</td> <td>X, X, X¹</td> <td>3</td> </tr> <tr> <td>Old Urban/Old Industrial</td> <td>X, X, X¹</td> <td>3</td> </tr> <tr> <td>New Urban/Old Urban</td> <td>X, X, X¹</td> <td>3</td> </tr> </tbody> </table> <p>1 – “X” represents a sample from a selected HDS unit. Yield categories will be determined during site selection.</p> <ul style="list-style-type: none"> Exclude units at full sump capacity (cleanout and monitor subsequent year if possible) 	Predominant Land Use	HDS Samples	No. Samples (Total 9)	Higher Concentration/Old Industrial	X, X, X ¹	3	Old Urban/Old Industrial	X, X, X ¹	3	New Urban/Old Urban	X, X, X ¹	3
Predominant Land Use	HDS Samples	No. Samples (Total 9)											
Higher Concentration/Old Industrial	X, X, X ¹	3											
Old Urban/Old Industrial	X, X, X ¹	3											
New Urban/Old Urban	X, X, X ¹	3											
Constituent List	TOC, total mercury, PCBs (40 congeners) in sediment, particle size distribution, and bulk density												
Data Analysis	Independent (unpaired) samples. Present range of total PCB and mercury concentrations measured and mass removed/area treated. Analyze using ANOVA. Model estimates of catchment stormwater volumes and PCB and mercury stormwater loads combined with the measured mass captured in the unit to calculate the percent removal.												

Table 8.4 Enhanced BSM Testing Study Design

Primary Management Question(s)	Are there readily available biochar-amended BSM that provide significantly better PCB and mercury load reductions than standard BSM and meet MRP infiltration rate requirements?																								
Type of Study	Influent-effluent monitoring																								
Data Objective(s)	PCB and mercury load removal																								
Description of Key Treatment Processes	Filtration and Adsorption <ul style="list-style-type: none"> Removal by physical screening, trapping in media, and retention on media surface Effectiveness depends on influent water quality, BMP design and hydraulic loading/flow regime, media type and properties, and operational factors 																								
Key Variables	<ul style="list-style-type: none"> Influent and effluent quality (PCB concentration, particle concentration, organic matter, proportion of dissolved contaminants, particle size, particle size distribution) BMP design (media depth) and hydraulic loading/head Media type and properties (composition, grain size/size distribution, adsorptive properties, hydraulic conductivity) BMP maintenance (surface clogging, short-circuiting) 																								
Monitoring Needs	<p>Monitored variables: Influent and effluent quality contaminant concentration, particle concentration, organic matter, surface clogging</p> <p>Controlled variables: media depth, hydraulic loading/head, media composition and adsorptive properties, hydraulic conductivity</p> <p>Uncontrolled variables: Influent and effluent proportion of dissolved contaminants, particle size, particle size distribution, short-circuiting</p>																								
Monitoring Approach	<p>Phased approach because of number of media/need to ensure MRP infiltration rates</p> <ol style="list-style-type: none"> Hydraulic tests to ensure amended media meet infiltration requirements Influent-effluent column tests for select mixes with Bay Area stormwater Influent-effluent column tests for best mix with Bay Area stormwater at lower concentrations 																								
Sampling Design	<p>Phase I Hydraulic Tests:</p> <ul style="list-style-type: none"> Determine infiltration rates for media mixes with 25% biochar by volume If MRP infiltration rates not met, adjust biochar proportion and retest Target infiltration rate of 5 - 12 in/h for all mixes, attempt to control rate to +/- 1 in/hr. <p>Phase II Influent-Effluent Column Tests with Bay Area Stormwater (up to 5 mixes)</p> <table border="1" style="margin-left: auto; margin-right: auto;"> <thead> <tr> <th>Biochar/BSM Mix</th> <th>Column Samples</th> <th>No. Samples (Total 21)</th> </tr> </thead> <tbody> <tr> <td>A Mix</td> <td>X, X, X</td> <td>3</td> </tr> <tr> <td>B Mix</td> <td>X, X, X</td> <td>3</td> </tr> <tr> <td>C Mix</td> <td>X, X, X</td> <td>3</td> </tr> <tr> <td>D Mix</td> <td>X, X, X</td> <td>3</td> </tr> <tr> <td>E Mix</td> <td>X, X, X</td> <td>3</td> </tr> <tr> <td>Control Mix</td> <td>X, X, X</td> <td>3</td> </tr> <tr> <td>Influent</td> <td>X, X, X</td> <td>3</td> </tr> </tbody> </table> <p>Phase III Influent-Effluent Column Tests for Select Mix with Diluted Bay Area Stormwater</p> <ul style="list-style-type: none"> Perform tests with diluted stormwater, if necessary, to confirm effectiveness at concentrations representative of New Urban and New Industrial land Test at one dilution (1 influent and 1 mix and 1 control effluent) (3 samples) 	Biochar/BSM Mix	Column Samples	No. Samples (Total 21)	A Mix	X, X, X	3	B Mix	X, X, X	3	C Mix	X, X, X	3	D Mix	X, X, X	3	E Mix	X, X, X	3	Control Mix	X, X, X	3	Influent	X, X, X	3
Biochar/BSM Mix	Column Samples	No. Samples (Total 21)																							
A Mix	X, X, X	3																							
B Mix	X, X, X	3																							
C Mix	X, X, X	3																							
D Mix	X, X, X	3																							
E Mix	X, X, X	3																							
Control Mix	X, X, X	3																							
Influent	X, X, X	3																							
Constituent List	SSC, turbidity, TOC, total mercury, PCBs (40 congeners) in water																								
Data Analysis	Dependent (paired) samples. Present range of total PCB and mercury concentrations measured and mass removal efficiencies. Analyze using ANOVA and regressions of influent/effluent quality. Perform sign-rank test to compare consistency in relative performance among the columns.																								

8.6 Adequacy of Study Design

The primary management questions are reviewed in this section in light of the budgeted data collection efforts. The primary management questions are restated and followed by an analysis of the adequacy of the data collection effort.

1. *What are the annual PCB and mercury loads captured by existing HDS units in Bay Area urban watersheds?*

Table 8.3 lists the number of data points that are anticipated for the HDS monitoring study.

This selected design will provide 9 data points for each of the following: PCB sediment concentration, mercury sediment concentration, and sediment mass. This design will not be able to assess the effect of HDS size and hydraulic loading on pollutant removal, and may not be able to statistically differentiate load capture between different land uses because of the small sample count for each land use (3). However, this design is selected because of the lack of information available on HDS sizing and the opportunistic nature of the sampling which limits the number of HDS units that can be sampled. The effect of maintenance is eliminated by ensuring that samples are not collected from units that have no remaining sump capacity.

The HDS study design collects independent (unpaired) samples since each HDS unit is sampled independently and there is no relationship between the various HDS units. This limits ability to discern differences due to land use or HDS size, especially when sample size is relatively low and there is considerable variability in the data collected. Although the study design yields 9 data points for each data objective, it may not be sufficient to draw statistically-based conclusions. However, the study will provide point estimates of loads removed during cleanouts and how they vary for different land uses (e.g., X g of PCBs are removed per unit area of Y land use). This is the metric used for effectiveness of HDS cleanouts, so the study will provide a practical improvement in knowledge that can be applied to future HDS effectiveness estimates.

In addition, modeled stormwater flows and associated POC loads to each HDS unit catchment during the time period between cleanouts will be developed. These modeled estimates will be used along with the measured mass captured in the HDS unit between cleanouts to quantify the percent removal for each unit during the study.

2. *Are there readily available biochar-amended BSM that provide significantly better PCB and mercury load reductions than standard BSM and meet MRP infiltration rate requirements?*

Table 8.4 lists the number of data points that are anticipated for the enhanced BSM testing study. The sampling design will yield 19 data points for each of the following: effluent PCB concentration, effluent mercury concentration. Including influent analysis, a total of 24 samples will be analyzed. The purpose of this study is to identify the best biochar amended BSM mixes for field testing and not test the effect of confounding variables such as influent quality and hydraulic loading on load removals. The study design accounts for these confounding variables by either ensuring their effect is randomized (e.g., influent water quality) or keeps them fixed (e.g., hydraulic loading). To ensure influent stormwater concentrations are representative of typical Bay Area concentrations, an additional column test with diluted

stormwater is performed on an effective media mix. Standard BSM controls are used for each column run so that removal by biochar amended mixes can be compared directly to removal by standard BSM. Infiltration experiments are performed prior to the column testing to ensure media selected for final column testing will meet the MRP infiltration rate requirements.

The enhanced BSM column study design collects dependent (paired) samples since each effluent sample is related to a corresponding influent sample. Additionally, standard BSM controls are used for each run which makes it possible to directly compare effluent quality for each amended BSM to standard BSM. The paired sampling design, use of standard BSM controls, and ability to control or fix many of the variables that effect load removal increase the ability to discern differences in treatment. Therefore, only 3 column runs are proposed, and available budget is instead used in initial hydraulic screening experiments to ensure selected media mixes meet MRP infiltration rate requirements. The study design may not be sufficient to draw statistically-based conclusions because it yields only 3 data points for each biochar mix tested. However, the study will enable direct comparisons of effluent quality and treatment between mixes for individual events and consistency of treatment between events. The information provided by the study is expected to be sufficient to identify the most promising biochar mixes for field testing.

The study designs for the HDS monitoring and enhanced bioretention studies meet MRP sample collection requirements. The sampling design for the HDS monitoring study will yield a minimum of 9 PCB and mercury data points, while the sampling design for the enhanced bioretention laboratory study will yield 24 PCB and mercury data points (including influent analysis). The minimum number of PCB samples for this study plan is 33 (9+24). Because 3 of the 32 BMP effectiveness samples required by the current MRP have already been collected, the minimum number required for this project is 29. This study must yield 29 of the 32 permit-required samples, per Provision C.8.f of the MRP. To ensure that at least 29 samples are collected to meet the MRP requirement, additional samples will be collected during the laboratory media testing runs if fewer than 5 HDS units are available for sampling.

9. Recommendations for Sampling and Analysis Plans

This section presents specific recommendations for the development of SAPs. More detailed information is available in Section 6 of the Caltrans Monitoring Guidance Manual (Caltrans, 2015) and in the Urban Stormwater BMP Performance Monitoring (WERF 2009). Analysis of constituents should follow the CW4CB Quality Assurance Project Plan (BASMAA 2013).

9.1 HDS Monitoring

The following SAP recommendations are based on the lessons learned from sampling the Leo Avenue HDS site (BASMAA, 2017b):

- Include equipment to determine sump capacity before sampling. The study design does not require sampling of units that are full (i.e., have no remaining sump capacity). The depth of the unit can make it difficult to inspect for sump basin contents, and use of a “sludge judge” or other similar equipment may not be possible because of difficulty penetrating through compacted organic materials.
- The sampling is expected to be opportunistic sampling during regular cleanouts. Since it coincides with regular maintenance patterns, the occurrence of a clean and empty vactor truck from which samples of the sediment can be taken is unlikely. To obtain representative samples, multiple grab samples that extend from the top of the sediment layer to the bottom of the sump will need to be collected and composited prior to analyses.
- Sediment samples will require screening to remove coarse particles, trash, etc. In the CW4CB study (BASMAA, 2007b), only sediment less than 2 mm in size was analyzed.

It is unclear how samples of the HDS sediment were taken in the Leo Avenue HDS sampling. Appropriate sampling methods should be developed to ensure the samples collected are representative of the sediment in the HDS units.

HDS sediment sampling is not expected to require additional handling/safety precautions beyond normal drain cleaning safety procedures. Human health criteria for PCBs are for exposure via ingestion or vapor intake and not for contact. OSHA directive STD 01-04-002 state that “repeated skin contact hazards with all PCB's could be addressed by the standards 1910.132 and 1910.133”. Both 1910.132 and 1910.133 OSHA standards require use of personal protective equipment, including eye and face protection.

9.2 Enhanced Bioretention Media Testing

The following SAP recommendations are based on past experience and specific guidance provided in DEMEAU (2014):

- The enhanced BSM testing will use real stormwater for the column experiments to account for the effect of influent water quality on load removal. A stormwater

collection site will need to be identified in a watershed with typical PCB concentrations to ensure PCB concentrations are representative of those expected in Bay Area urban watersheds. Also, guidance will need to be developed on mobilization to ensure storms are targeted randomly.

- Stormwater properties are known to change significantly with time due to natural flocculation and settling of particles. Appropriate procedures should be developed to ensure collected stormwater is well mixed at all times, and experiments are performed in a timely manner to insure the stormwater used is representative.
- PCBs can readily attach to test equipment, including the inside of tubing that may be used for pumps and the inside of PVC columns. Alternatives should be considered that eliminate the need for pumping equipment and reduce attachment within columns (e.g., by use of glass columns).
- The results of column experiments can be affected by channeling and wall effects. Use a column diameter to particle diameter ratio greater than about 40 to minimize these.
- How media is packed in columns will affect infiltration rates and treatment performance. Therefore, detailed procedures should be developed for the packing of media in columns to ensure consistency between columns and between experiments.

9.3 Data Quality Objectives

Data quality objectives (DQOs) should follow standard stormwater monitoring protocols and be described in detail in individual SAPs. Both sampling and laboratory data quality objectives should be included. For sampling, the SAP should specify sediment and water collection procedures and equipment as well as sample volume and handling requirements. For laboratories, numeric DQOs are appropriate for sample blanks, duplicates (or field splits), and matrix spike recovery.

10. References

BASMAA, 2013. Quality Assurance Project Plan (QAPP). Clean Watersheds for a Clean Bay – Implementing the San Francisco Bay’s PCBs and Mercury TMDLs with a Focus on Urban Runoff. August 15, 2013.

BASMAA, 2014. Integrated Monitoring Report Part B: PCB and Mercury Loads Avoided and Reduced via Stormwater Control Measures. Bay Area Stormwater Management Agencies Association.

BASMAA, 2016a. Regional Biotreatment Soil Specification: Specification of Soils for Biotreatment or Bioretention Facilities. Bay Area Stormwater Management Agencies Association.

BASMAA, 2016b. Interim Accounting Methodology for TMDL Loads Reduced. Bay Area Stormwater Management Agencies Association.

BASMAA, 2017a. Clean Watersheds for a Clean Bay Project Report, Final Report May 2017. Bay Area Stormwater Management Agencies Association.

BASMAA, 2017b. Clean Watersheds for a Clean Bay Task 5: Stormwater Treatment Retrofit Pilot Projects Stormwater Treatment Retrofit - 7th Street Hydrodynamic Separator Unit draining the Leo Avenue Watershed, San Jose, CA. Bay Area Stormwater Management Agencies Association.

BASMAA, 2017c. Bay Area Reasonable Assurance Analysis Guidance Document. Project Number: WW2282, June 2017. Bay Area Stormwater Management Agencies Association.

Caltrans, 2009. BMP Pilot Study Guidance Manual. Document No. CTSW-RT-06-171.02.1. California Department of Transportation, Sacramento.

Caltrans, 2015. Caltrans Stormwater Monitoring Guidance Manual, November 2015. Document No. CTSW-OT-15-999.43.01. California Department of Transportation, Sacramento.

City of San Diego, 2012. Catch Basin Inlet Cleaning Pilot Study Final Report, June 2012. The City of San Diego, California.

City of Spokane, 2015. PCB Characterization of Spokane Regional Vector Waste Decant Facilities, Prepared for the Spokane River Regional Toxics Taskforce September, 2015. City of Spokane RPWRF Laboratory.

City of Tacoma, 2015. East Tacoma PCB Investigation: Results & Next Steps. November 20, 2013. City of Tacoma Environmental Services.

[City of Tacoma PCB Presentation](#). Last Assessed May 28, 2017.

DEMEAU, 2014. Guidelining protocol for soil-column experiments assessing fate and transport of trace organics. Demonstration of promising technologies to address emerging pollutants in water and waste water project. European Union Seventh Programme for Research, Technological Development and Demonstration under Grant Agreement No. 308330.

Gomez-Eyles, J. L., C. Yupanqui, B. Beckingham, G. Riedel, C. Gilmour, and U. Ghosh, 2013. Evaluation of Biochars and Activated Carbons for In Situ Remediation of Sediments Impacted with Organics, Mercury, and Methylmercury. *Environ. Sci. Technol.*, 47, 13721–13729.

Kitsap County, 2015. Analysis of Bioretention Soil Media for Improved Nitrogen, Phosphorus and Copper Retention, Final Report. Kitsap County Public Works, Washington.

Liu, P., C. J. Ptacek, D. W. Blowes, and R. C. Landis, 2015. Mechanisms of mercury removal by biochars produced from different feedstocks determined using X-ray absorption spectroscopy. *Journal of Hazardous Materials*, 308 (2016) 233–242.

SFBRWQCB, 2012. San Francisco Bay Regional Water Quality Control Board. Total Maximum Daily Loads (TMDLs) and the 303(d) List of Impaired Water Bodies. 2012.

SFBRWQCB, 2015. Municipal Regional Stormwater NPDES Permit, Order No. R2-2015-0049. NPDES Permit No. CAS612008. November 19, 2015

SFEI, 2015. Sources, Pathways and Loadings: Multi-Year Synthesis with a Focus on PCBs and Hg. Report for Regional Monitoring Program for Water Quality in San Francisco Bay (RMP), Sources Pathways and Loadings Workgroup (SPLWG), Small Tributaries Loading Strategy (STLS). 2015.

WERF, 2009. Urban Stormwater BMP Performance Monitoring. Water Environment Research Foundation.

[Urban Stormwater BMP Performance Monitoring](#). Last accessed August 6, 2012.

Wilson M. A., O. Mohseni, J. S. Gulliver, R. M. Hozalski, and H. G. Stefan, 2009. Assessment of Hydrodynamic Separators for Storm-Water Treatment. *J. Hydraul. Eng.*, 2009, 135(5): 383-392.

Yargicoglu, E. N. and K. R. Reddy, 2015. Characterization and Surface Analysis of Commercially Available Biochars for Geoenvironmental Applications. IFCEE2015, San Antonio, TX, March 17-21, 2015.

Yee, D., and L. J. McKee, 2010. Task 3.5: Concentrations of PCBs and Hg in soils, sediments and water in the urbanized Bay Area: Implications for best management. A technical report of the Watershed Program. SFEI Contribution 608. San Francisco Estuary Institute, Oakland CA.



APPENDIX B: SAMPLING AND ANALYSIS PLAN AND QUALITY ASSURANCE PROJECT PLAN

BASMAA Regional Monitoring Coalition

Pollutants of Concern Monitoring for Source Identification and Management Action Effectiveness, 2017-2018

Sampling and Analysis Plan and Quality Assurance Project Plan

Prepared for:

The Bay Area Stormwater Management Agencies Association (BASMAA)

Prepared by:



1410 Jackson Street
Oakland, CA
94612



6000 J Street
Sacramento, CA
95819



4911 Central Avenue
Richmond, CA
94804



307 Washington Street
Santa Cruz, CA
95060

Version 2
September 29, 2017

Title and Approval Sheet

Program Title Pollutants of Concern (POC) Monitoring for Source Identification
and Management Action Effectiveness

Lead Organization Bay Area Stormwater Management Agencies Association (BASMAA)

P.O. Box 2385, Menlo Park, CA 94026, 510-622-2326

info@basmaa.org

Primary Contact Geoff Brosseau

Effective Date September 29, 2017

Revision Number Version 2

Approval Signatures:

A signature from the BASMAA Executive Director approving the BASMAA POC Monitoring for Source Identification and Management Action Effectiveness is considered approval on behalf of all Program Managers.

Geoff Brosseau

Date

TABLE OF CONTENTS

TITLE AND APPROVAL SHEET 2
 APPROVAL SIGNATURES: 2

1. PROBLEM DEFINITION/BACKGROUND 9
 1.1. PROBLEM STATEMENT 9
 1.2. OUTCOMES..... 10

2. DISTRIBUTION LIST AND CONTACT INFORMATION..... 11

3. PROGRAM ORGANIZATION 11
 3.1. INVOLVED PARTIES AND ROLES..... 11
 3.2. BASMAA PROJECT MANAGER (BASMAA-PM) 12
 3.3. BASMAA PROJECT MANAGEMENT TEAM (PMT)..... 13
 3.4. CONSULTANT TEAM PROJECT MANAGER (CONSULTANT-PM) 13
 3.5. QUALITY ASSURANCE OFFICER (QA OFFICER)..... 13
 3.6. DATA MANAGER (DM) 13
 3.7. FIELD CONTRACTOR PROJECT MANAGER (FIELD-PM) 13
 3.8. LABORATORY PROJECT MANAGER (LAB-PM)..... 14
 3.1. REPORT PREPARER..... 14

4. MONITORING PROGRAM DESCRIPTION..... 14
 4.1. WORK STATEMENT AND PROGRAM OVERVIEW 14
 4.2. SAMPLING DETAIL..... 15
 4.2.1. Task 1 - Caulk/Sealant samples 15
 4.2.2. Task 2 - Sediment samples from HDS Units 16
 4.2.3. Task 3 - Storm Water and Column Test Samples 16
 4.3. SCHEDULE..... 17
 4.4. GEOGRAPHICAL SETTING 17
 4.5. CONSTRAINTS 17

5. MEASUREMENT QUALITY OBJECTIVES (MQO) 18
 5.1. REPRESENTATIVENESS AND COMPARABILITY 18
 5.2. COMPLETENESS 19
 5.3. SENSITIVITY 19
 5.4. PRECISION 19
 5.5. ACCURACY..... 20
 5.6. CONTAMINATION..... 20

6. SPECIAL TRAINING NEEDS / CERTIFICATION 21

7. PROGRAM DOCUMENTATION AND REPORTING 21
 7.1. FIELD DOCUMENTATION..... 22
 7.1.1. Sampling Plans, COCs, and Sampling Reports 22
 7.1.2. Data Sheets 22
 7.1.3. Photographic Documentation..... 22
 7.2. LABORATORY DOCUMENTATION 22
 7.2.1. Data Reporting Format..... 22
 7.2.2. Other Laboratory QA/QC Documentation..... 23
 7.3. PROGRAM MANAGEMENT DOCUMENTATION..... 24
 7.3.1. SAP/QAPP 24
 7.3.2. Program Information Archival..... 24
 7.4. REPORTING..... 25

8.	SAMPLING PROCESS DESIGN	25
8.1.	CAULK/SEALANT SAMPLING.....	25
8.2.	SEDIMENT QUALITY SAMPLING	25
8.3.	WATER QUALITY SAMPLING	26
8.4.	SAMPLING UNCERTAINTY	26
9.	SAMPLING METHODS.....	26
9.1.	CAULK/SEALANT SAMPLING (TASK 1).....	27
9.1.1.	<i>Sample Site Selection.....</i>	27
9.1.2.	<i>Initial Equipment Cleaning</i>	27
9.1.3.	<i>Field Cleaning Protocol.....</i>	27
9.1.4.	<i>Blind Sampling Procedures.....</i>	27
9.1.5.	<i>Caulk/Sealant Collection Procedures.....</i>	28
9.1.6.	<i>Sample ID Designation</i>	29
9.2.	HDS UNIT SAMPLING PROCEDURES (TASK 2)	29
9.2.1.	<i>Sample Site Selection.....</i>	29
9.2.2.	<i>Field Equipment and Cleaning.....</i>	29
9.2.3.	<i>Soil / Sediment Sample Collection</i>	30
9.2.4.	<i>Sample ID Designation</i>	31
9.3.	WATER QUALITY SAMPLING AND COLUMN TESTING PROCEDURES (TASK 3)	32
9.3.1.	<i>Sample Site Selection.....</i>	32
9.3.2.	<i>Field Equipment and Cleaning.....</i>	32
9.3.3.	<i>Water Sampling Procedures.....</i>	32
9.3.4.	<i>Hydraulic Testing.....</i>	32
9.3.5.	<i>Column Testing Procedures</i>	33
9.3.6.	<i>Sample ID Designations</i>	34
9.4.	COLLECTION OF SAMPLES FOR ARCHIVING.....	35
9.5.	WASTE DISPOSAL.....	35
9.5.1.	<i>Routine Garbage.....</i>	35
9.5.2.	<i>Detergent Washes.....</i>	35
9.5.3.	<i>Chemicals.....</i>	35
9.1.	RESPONSIBILITY AND CORRECTIVE ACTIONS	35
9.2.	STANDARD OPERATING PROCEDURES.....	35
10.	SAMPLE HANDLING AND CUSTODY.....	36
10.1.	SAMPLING CONTAINERS.....	36
10.2.	SAMPLE PRESERVATION	37
10.3.	PACKAGING AND SHIPPING	37
10.4.	COMMERCIAL VEHICLE TRANSPORT.....	37
10.5.	SAMPLE HOLD TIMES	37
11.	FIELD HEALTH AND SAFETY PROCEDURES	39
12.	LABORATORY ANALYTICAL METHODS	39
12.1.	CAULK/SEALANT SAMPLES (TASK 1).....	39
12.1.1.	<i>XRF Chlorine analysis.....</i>	39
12.1.2.	<i>Selection of Samples for PCB analysis and Compositing.....</i>	39
12.1.3.	<i>Sample Preparation</i>	40
12.1.4.	<i>PCBs Analysis.....</i>	40
12.2.	SEDIMENT SAMPLES COLLECTED FROM HDS UNITS (TASK 2).....	41
12.3.	WATER SAMPLES – STORMWATER AND COLUMN TESTS (TASK 3).....	41
12.4.	METHOD FAILURES.....	41

12.5.	SAMPLE DISPOSAL.....	42
12.6.	LABORATORY SAMPLE PROCESSING	42
13.	QUALITY CONTROL.....	42
13.1.	FIELD QUALITY CONTROL.....	42
13.1.1.	<i>Field Blanks</i>	43
13.1.2.	<i>Field Duplicates</i>	43
13.1.3.	<i>Field Corrective Action</i>	43
13.2.	LABORATORY QUALITY CONTROL.....	44
13.2.1.	<i>Calibration and Working Standards</i>	45
13.2.2.	<i>Instrument Calibration</i>	45
13.2.3.	<i>Initial Calibration Verification</i>	45
13.2.4.	<i>Continuing Calibration Verification</i>	45
13.2.5.	<i>Laboratory Blanks</i>	46
13.2.6.	<i>Reference Materials and Demonstration of Laboratory Accuracy</i>	46
13.2.7.	<i>Reference Materials vs. Certified Reference Materials</i>	46
13.2.8.	<i>Laboratory Control Samples</i>	47
13.2.9.	<i>Prioritizing Certified Reference Materials, Reference Materials, and Laboratory Control Samples</i>	47
13.2.10.	<i>Matrix Spikes</i>	47
13.2.11.	<i>Laboratory Duplicates</i>	48
13.2.12.	<i>Laboratory Duplicates vs. Matrix Spike Duplicates</i>	48
13.2.13.	<i>Replicate Analyses</i>	48
13.2.14.	<i>Surrogates</i>	48
13.2.15.	<i>Internal Standards</i>	48
13.2.16.	<i>Dual-Column Confirmation</i>	49
13.2.17.	<i>Dilution of Samples</i>	49
13.2.18.	<i>Laboratory Corrective Action</i>	49
14.	INSPECTION/ACCEPTANCE FOR SUPPLIES AND CONSUMABLES	56
15.	NON DIRECT MEASUREMENTS, EXISTING DATA	56
16.	DATA MANAGEMENT	56
16.1.	FIELD DATA MANAGEMENT	56
16.2.	LABORATORY DATA MANAGEMENT	56
17.	ASSESSMENTS AND RESPONSE ACTIONS	57
17.1.	READINESS REVIEWS.....	57
17.2.	POST SAMPLING EVENT REVIEWS.....	57
17.3.	LABORATORY DATA REVIEWS	57
18.	INSTRUMENT/EQUIPMENT TESTING, INSPECTION AND MAINTENANCE	58
18.1.	FIELD EQUIPMENT	58
18.2.	LABORATORY EQUIPMENT	58
19.	INSTRUMENT/EQUIPMENT CALIBRATION AND FREQUENCY	59
19.1.	FIELD MEASUREMENTS.....	59
19.2.	LABORATORY ANALYSES.....	59
19.2.1.	<i>In-house Analysis – XRF Screening</i>	59
19.2.2.	<i>Contract Laboratory Analyses</i>	59
20.	DATA REVIEW, VERIFICATION, AND VALIDATION	60
21.	VERIFICATION AND VALIDATION METHODS	61

22.	RECONCILIATION WITH USER REQUIREMENTS.....	61
23.	REFERENCES.....	62
24.	APPENDIX A: FIELD DOCUMENTATION	63
25.	APPENDIX B: LABORATORY STANDARD OPERATING PROCEDURES (SOPS).....	69

List of Tables

TABLE 2-1. BASMAA SAP/QAPP DISTRIBUTION LIST	11
TABLE 3-1. SAN FRANCISCO BAY AREA STORMWATER PROGRAMS AND ASSOCIATED MRP PERMITTEES PARTICIPATING IN THE BASMAA MONITORING PROGRAM.....	12
TABLE 7-1. DOCUMENT AND RECORD RETENTION, ARCHIVAL, AND DISPOSITION	24
TABLE 7-2. MONITORING PROGRAM FINAL REPORTING DUE DATES.	25
TABLE 9-1 FIELD EQUIPMENT FOR HDS UNIT SAMPLING.....	30
TABLE 9-2 STATION CODES FOR STORMWATER INFLUENT SAMPLES AND COLUMN TESTS.	35
TABLE 9-3. LIST OF BASMAA RMC SOPs UTILIZED BY THE MONITORING PROGRAM.....	36
TABLE 10-1 SAMPLE HANDLING FOR THE MONITORING PROGRAM ANALYTES BY MEDIA TYPE.	38
TABLE 12-1. LABORATORY ANALYTICAL METHODS FOR ANALYTES IN SEDIMENT.....	41
TABLE 12-2. LABORATORY ANALYTICAL METHODS FOR ANALYTES IN WATER.....	41
TABLE 13-1. MEASUREMENT QUALITY OBJECTIVES - PCBs.	50
TABLE 13-2. MEASUREMENT QUALITY OBJECTIVES – INORGANIC ANALYTES.....	51
TABLE 13-3. MEASUREMENT QUALITY OBJECTIVES – CONVENTIONAL ANALYTES.	52
TABLE 13-4. TARGET MRLs FOR SEDIMENT QUALITY PARAMETERS.	52
TABLE 13-5. TARGET MRLs FOR PCBs IN WATER, SEDIMENT AND CAULK.....	53
TABLE 13-6. SIZE DISTRIBUTION CATEGORIES FOR GRAIN SIZE IN SEDIMENT.....	54
TABLE 13-7. TARGET MRLs FOR TOC, SSC, AND MERCURY IN WATER	54
TABLE 13-8. CORRECTIVE ACTION – LABORATORY AND FIELD QUALITY CONTROL.....	55
TABLE 14-1. INSPECTION / ACCEPTANCE TESTING REQUIREMENTS FOR CONSUMABLES AND SUPPLIES.....	56

List of Acronyms

ACCWP	Alameda Countywide Clean Water Program
ALS	ALS Environmental Laboratory
BASMAA	Bay Area Stormwater Management Agencies Association
BSM	Bioretention Soil Media
CCCWP	Contra Costa Clean Water Program
CCV	continuing calibration verification
CEDEN	California Environmental Data Exchange Network
CEH	Center for Environmental Health
COC	Chain of Custody
Consultant-PM	Consultant Team Project Manager
CRM	Certified Reference Material
CSE	Confined Space Entry
ECD	Electron capture detection
EDD	Electronic Data Deliverable
EOA	Eisenberg, Olivieri & Associates, Inc.
EPA	Environmental Protection Agency (U.S.)
FD	Field duplicate
Field PM	Field Contractor Project Manager
FSURMP	Fairfield-Suisun Urban Runoff Management Program
GC-MS	Gas Chromatography-Mass Spectroscopy
IDL	Instrument Detection Limits
ICV	initial calibration verification
KLI	Kinnetic Laboratories Inc.
LCS	Laboratory Control Samples
Lab-PM	Laboratory Project Manager
MS/MSD	Matrix Spike/Matrix Spike Duplicate
MDL	Method Detection Limit
MQO	Measurement Quality Objective
MRL	Method Reporting Limit
MRP	Municipal Regional Permit
NPDES	National Pollutant Discharge Elimination System
OWP-CSUS	Office of Water Programs at California State University Sacramento
PCB	Polychlorinated Biphenyl
PM	Project Manager
PMT	Project Management Team
POC	Pollutants of Concern
QA	Quality Assurance
QA Officer	Quality Assurance Officer
QAPP	Quality Assurance Project Plan
QC	Quality Control
ROW	Right-of-way
RPD	Relative Percent Difference
RMC	Regional Monitoring Coalition
RMP	Regional Monitoring Program for Water Quality in the San Francisco Estuary
SFRWQCB	San Francisco Regional Water Quality Control Board (Regional Water Board)
SAP	Sampling and Analysis Plan
SCCVURPP	Santa Clara Valley Urban Runoff Pollution Prevention Program
SCVWD	Santa Clara Valley Water Department
SFEI	San Francisco Estuary Institute

SMCWPPP	San Mateo County Water Pollution Prevention Program
SOP	Standard Operating Procedure
SWAMP	California Surface Water Ambient Monitoring Program
TOC	Total Organic Carbon
TMDL	Total Maximum Daily Load
VSFCD	Vallejo Sanitation and Flood Control District

1. Problem Definition/Background

The Bay Area Stormwater Management Agencies Association (BASMAA) member agencies will implement a regional monitoring program for Pollutants of Concern (POC) Monitoring for Source Identification and Management Action Effectiveness (Monitoring Program). The Monitoring Program is intended to fulfill components of the Municipal Regional Stormwater NPDES Permit (MRP; Order No. R2-2015-0049), which implements the polychlorinated biphenyls (PCBs) and Mercury Total Maximum Daily Loads (TMDLs) for the San Francisco Bay Area. Monitoring for Source Identification and Management Action Effectiveness are two of five monitoring priorities for POCs identified in the MRP. Source identification monitoring is conducted to identify the sources or watershed source areas that provide the greatest opportunities for reductions of POCs in urban stormwater runoff. Management action effectiveness monitoring is conducted to provide support for planning future management actions or to evaluate the effectiveness or impacts of existing management actions.

BASMAA developed two study designs to implement each component of the Monitoring Program. The *Evaluation of PCBs Presence in Public Roadway and Storm Drain Infrastructure Caulk and Sealants Study Design* (BASMAA 2017a) addresses the source identification monitoring requirements of Provision C.8.f, as well as requirements of Provision C.12.e to investigate PCBs in infrastructure caulk and sealants. The *POC Monitoring for Management Action Effectiveness Study Design* (BASMAA 2017b) addresses the management action effectiveness monitoring requirements of Provision C.8.f. The results of the Monitoring Program will contribute to ongoing efforts by MRP Permittees to identify PCB sources and improve the PCBs and mercury treatment effectiveness of stormwater control measures in the Phase I permittee area of the Bay Area. This Sampling and Analysis Plan and Quality Assurance Project Plan (SAP/QAPP) was developed to guide implementation of both components of the Monitoring Program.

1.1. Problem Statement

Fish tissue monitoring in San Francisco Bay (Bay) has revealed bioaccumulation of PCBs and mercury. The measured fish tissue concentrations are thought to pose a health risk to people consuming fish caught in the Bay. As a result of these findings, California has issued an interim advisory on the consumption of fish from the Bay. The advisory led to the Bay being designated as an impaired water body on the Clean Water Act "Section 303(d) list" due to PCBs and mercury. In response, the California Regional Water Quality Control Board, San Francisco Bay Region (Regional Water Board) has developed TMDL water quality restoration programs targeting PCBs and mercury in the Bay. The general goals of the TMDLs are to identify sources of PCBs and mercury to the Bay and implement actions to control the sources and restore water quality.

Since the TMDLs were adopted, Permittees have conducted a number of projects to provide information that supports implementation of management actions designed to achieve the wasteload allocations described in the Mercury and PCBs TMDL, as required by Provisions of the MRP. The Clean Watersheds for a Clean Bay project (CW4CB) was a collaboration among BASMAA member agencies that pilot tested various stormwater control measures and provided estimates of the PCBs and mercury load reduction effectiveness of these controls (BASMAA, 2017c). However, the results of the CW4CB project identified a number of remaining data gaps on the load reduction effectiveness of the control measures

that were tested. In addition, MRP Provisions C.8.f. and C.12.e require Permittees to conduct further source identification and management action effectiveness monitoring during the current permit term.

1.2. Outcomes

The Monitoring Program will allow Permittees to satisfy MRP monitoring requirements for source identification and management action effectiveness, while also addressing some of the data gaps identified by the CW4CB project (BASMAA, 2017c). Specifically, the Monitoring Program is intended to provide the following outcomes:

1. Satisfy MRP Provision C.8.f. requirements for POC monitoring for source identification; and Satisfy MRP Provision C.12.e.ii requirements to evaluate PCBs presence in caulks/sealants used in storm drain or roadway infrastructure in public ROWs;
 - a. Report the range of PCB concentrations observed in 20 composite samples of caulk/sealant collected from structures installed or rehabilitated during the 1970's;
2. Satisfy MRP Provision C.8.f. requirements for POC monitoring for management action effectiveness;
 - a. Quantify the annual mass of mercury and PCBs captured in HDS Unit sumps during maintenance; and
 - b. Identify bioretention soil media (BSM) mixtures for future field testing that provide the most effective mercury and PCBs treatment in laboratory column tests.

The information generated from the Monitoring Program will be used by MRP Permittees and the Regional Water Board to better understand potential PCB sources and better estimate the load reduction effectiveness of current and future stormwater control measures.

2. Distribution List and Contact Information

The distribution list for this BASMAA SAP/QAPP is provided in Table 2-1.

Table 2-1. BASMAA SAP/QAPP Distribution List.

Project Group	Title	Name and Affiliation	Telephone No.
BASMAA Project Management Team	BASMAA Project Manager, Stormwater Program Specialist	Reid Bogert, SMCWPPP	650-599-1433
	Program Manager	Jim Scanlin, ACCWP	510-670-6548
	Watershed Management Planning Specialist	Lucile Paquette, CCCWP	925-313-2373
	Program Manager	Rachel Kraai, CCCWP	925-313-2042
	Technical Consultant to ACCWP and CCCWP	Lisa Austin, Geosyntec Inc. CCCWP	510-285-2757
	Supervising Environmental Services Specialist	James Downing, City of San Jose	408-535-3500
	Senior Environmental Engineer	Kevin Cullen, FSURMP	707-428-9129
	Pollution Control Supervisor	Doug Scott, VSFCO	707-644-8949 x269
Consultant Team	Project Manager	Bonnie de Berry, EOA Inc.	510-832-2852 x123
	Assistant Project Manager SAP/QAPP Author and Report Preparer	Lisa Sabin, EOA Inc.	510-832-2852 x108
	Technical Advisor	Chris Sommers, EOA Inc.	510-832-2852 x109
	Study Design Lead and Report Preparer	Brian Currier, OWP-CSUS	916-278-8109
	Study Design Lead and Report Preparer	Dipen Patel, OWP-CSUS	
	Technical Advisor	Lester McKee, SFEI	415-847-5095
	Quality Assurance Officer	Don Yee, SFEI	510-746-7369
	Data Manager	Amy Franz, SFEI	510-746-7394
Project Laboratories	Field Contractor Project Manager	Jonathan Toal, KLI	831-457-3950
	Laboratory Project Manager	Howard Borse, ALS	360-430-7733
	XRF Laboratory Project Manager	Matt Nevins, CEH	510-655-3900 x318

3. Program Organization

3.1. Involved Parties and Roles

BASMAA is a 501(c)(3) non-profit organization that coordinates and facilitates regional activities of municipal stormwater programs in the San Francisco Bay Area. BASMAA programs support implementation of the MRP (Order No. R2-2015-0049), which implements the PCBs and Mercury TMDLs for the San Francisco Bay Area. BASMAA is comprised of all 76 identified MRP municipalities and special districts, the Alameda Countywide Clean Water Program (ACCWP), Contra Costa Clean

Water Program (CCCWP), the Santa Clara Valley Urban Runoff Pollution Prevention Program (SCVURPPP), the San Mateo Countywide Water Pollution Prevention Program (SMCWPPP), the Fairfield-Suisun Urban Runoff Management Program (FSURMP), the City of Vallejo and the Vallejo Sanitation and Flood Control District (VSFCD) (Table 3-1).

MRP Permittees have agreed to collectively implement this Monitoring Program via BASMAA. The Program will be facilitated through the BASMAA Monitoring and Pollutants of Concern Committee (MPC). BASMAA selected a consultant team to develop and implement the Monitoring Program with oversight and guidance from a BASMAA Project Management Team (PMT), consisting of representatives from BASMAA stormwater programs and municipalities (Table 3-1).

Table 3-1. San Francisco Bay Area Stormwater Programs and Associated MRP Permittees Participating in the BASMAA Monitoring Program.

Stormwater Programs	MRP Permittees
Santa Clara Valley Urban Runoff Pollution Prevention Program (SCVURPPP)	Cities of Campbell, Cupertino, Los Altos, Milpitas, Monte Sereno, Mountain View, Palo Alto, San Jose, Santa Clara, Saratoga, Sunnyvale, Los Altos Hills, and Los Gatos; Santa Clara Valley Water District; and, Santa Clara County
Alameda Countywide Clean Water Program (ACCWP)	Cities of Alameda, Albany, Berkeley, Dublin, Emeryville, Fremont, Hayward, Livermore, Newark, Oakland, Piedmont, Pleasanton, San Leandro, and Union City; Alameda County; Alameda County Flood Control and Water Conservation District; and, Zone 7 Water District
Contra Costa Clean Water Program (CCCWP)	Cities of, Clayton, Concord, El Cerrito, Hercules, Lafayette, Martinez, , Orinda, Pinole, Pittsburg, Pleasant Hill, Richmond, San Pablo, San Ramon, Walnut Creek, Danville, and Moraga; Contra Costa County; and, Contra Costa County Flood Control and Water Conservation District
San Mateo County Wide Water Pollution Prevention Program (SMCWPPP)	Cities of Belmont, Brisbane, Burlingame, Daly City, East Palo Alto, Foster City, Half Moon Bay, Menlo Park, Millbrae, Pacifica, Redwood City, San Bruno, San Carlos, San Mateo, South San Francisco, Atherton, Colma, Hillsborough, Portola Valley, and Woodside; San Mateo County Flood Control District; and, San Mateo County
Fairfield-Suisun Urban Runoff Management Program (FSURMP)	Cities of Fairfield and Suisun City
Vallejo Permittees (VSFCD)	City of Vallejo and Vallejo Sanitation and Flood Control District

3.2. BASMAA Project Manager (BASMAA-PM)

The BASMAA Project Manager (BASMAA-PM) will be responsible for directing the activities of the below-described PMT, and will provide oversight and managerial level activities, including reporting status updates to the PMT and BASMAA, and acting as the liaison between the PMT and the Consultant Team. The BASMAA PM will oversee preparation, review, and approval of project deliverables, including the required reports to the Regional Water Board.

3.3. BASMAA Project Management Team (PMT)

The BASMAA PMT will assist the BASMAA-PM and the below described Consultant Team with the design and implementation of all project activities. PMT members will assist the BASMAA-PM and Consultant Team to complete project activities within scope, on-time, and within budget by having specific responsibility for planning and oversight of project activities within the jurisdiction of the BASMAA agency that they represent. In addition, the PMT will coordinate with the municipal project partners and key regional agencies, including the Regional Water Board. The PMT is also responsible for reviewing and approving project deliverables (e.g., draft and final project reports).

3.4. Consultant Team Project Manager (Consultant-PM)

The Consultant Team Project Manager (Consultant-PM) will be responsible for ensuring all work performed during the Monitoring Program is consistent with project goals, and provide oversight of all day-to-day operations associated with implementing all components of the Monitoring Program, including scheduling, budgeting, reporting, and oversight of subcontractors. The Consultant-PM will ensure that data generated and reported through implementation of the Monitoring Program meet measurement quality objectives (MQOs) described in this SAP/QAPP. The Consultant -PM will work with the Quality Assurance Officer as required to resolve any uncertainties or discrepancies. The Consultant -PM will also be responsible for overseeing development of draft and final reports for the Monitoring Program, as described in this SAP/QAPP.

3.5. Quality Assurance Officer (QA Officer)

The role of the Quality Assurance Officer (QA Officer) is to provide independent oversight and review of the quality of the data being generated. In this role, the QA Officer has the responsibility to require data that is of insufficient quality to be flagged, or not used, or for work to be redone as necessary so that the data meets specified quality measurements. The QA Officer will oversee the technical conduct of the field related components of the Monitoring Program, including ensuring field program compliance with the SAP/QAPP for tasks overseen at the programmatic level.

3.6. Data Manager (DM)

The Data Manager will be responsible for receipt and review of all project related documentation and reporting associated with both field efforts and laboratory analysis. The Data Manager will also be responsible for storage and safekeeping of these records for the duration of the project.

3.7. Field Contractor Project Manager (Field-PM)

The Field Contractor Project Manager (Field-PM) will be responsible for conduct and oversight of all field monitoring- and reporting-related activities, including completion of field datasheets, chain of custodies, and collection of field measurements and field samples, consistent with the monitoring methods and procedures in the SAP/QAPP. The Field-PM will also be responsible for ensuring that personnel conducting monitoring are qualified to perform their responsibilities and have received appropriate training. The Field-PM will be responsible for initial receipt and review of all project related documentation and reporting associated with both field efforts and laboratory analysis.

The Field-PM will also be responsible for receiving all samples collected opportunistically by participating municipalities, including all caulk/sealant samples, initial review of sample IDs to ensure there are no duplicate sample IDs, and shipping the samples under COC to the appropriate laboratory (CEH for the caulk/sealant samples; ALS for all other samples). Participating municipalities should ship all samples they collect to the Field PM at the following address:

Jon Toal
Kinnetic Laboratories, Inc.
307 Washington Street
Santa Cruz, CA 95060
Reference: BASMAA POC Monitoring Project
(831)457-3950

3.8. Laboratory Project Manager (Lab-PM)

The Laboratory Project Manager (Lab-PM) and chemists at each analytical laboratory will be responsible for ensuring that the laboratory's quality assurance program and standard operating procedures (SOPs) are consistent with this SAP/QAPP, and that laboratory analyses meet all applicable requirements or explain any deviations. Each Lab-PM will also be responsible for coordinating with the Field-PM and other staff (e.g., Consultant -PM, Data Manager, QA Officer) and facilitating communication between the Field-PM, the Consultant -PM, and analytical laboratory personnel, as required for the project.

The Center for Environmental Health (CEH) will provide chlorine content screening of all caulk/sealant samples collected using X-Ray Fluorescence (XRF) technology to assist in selection of samples for further laboratory analysis of PCBs. This XRF-screening will also provide additional information on the utility of XRF in prioritizing samples for chemical PCBs analyses.

All other laboratory analyses will be provided by ALS Environmental.

3.1. Report Preparer

The Report Preparer (RP) will be responsible for developing draft and final reports for each of the following components of the Monitoring Program: (1) Source identification; and (2) Management action effectiveness. All draft reports will be submitted to the PMT for review and input prior to submission for approval by the BASMAA Board of Directors (BOD).

4. Monitoring Program Description

4.1. Work Statement and Program Overview

The Monitoring Program consists of the following three major tasks, each of which has a field sampling component:

- **Task 1. Evaluate presence and possible concentrations of PCBs in roadway and storm drain infrastructure caulk and sealants.** This task involves analysis of 20 composite samples of caulk/sealant collected from public roadway and storm drain infrastructure throughout the permit

area to investigate PCB concentrations. The goal of this task is to evaluate, at a limited screening level, whether and in what concentrations PCBs are present in public roadway and storm drain infrastructure caulk and sealants in the portions of the Bay Area under the jurisdiction of the Phase I Permittees identified in Table 3-1 (Bay Area).

- **Task 2. Evaluate Annual mass of PCBs and mercury captured in Hydrodynamic Separator (HDS) Unit sumps during maintenance.** This task involves collecting sediment samples from the sumps of public HDS unit during maintenance cleanouts to evaluate the mass of PCBs and mercury captured by these devices. The goal of this task is to provide data to better characterize the concentrations of POCs in HDS Unit sump sediment and improve estimates of the mass captured and removed from these units during current maintenance practices for appropriate TMDL load reduction crediting purposes.
- **Task 3. Bench-scale testing of the mercury and PCBs removal effectiveness of selected BSM mixtures enhanced with biochar.** This task involves collecting stormwater from the Bay Area that will then be used to conduct laboratory column tests designed to evaluate the mercury and PCBs treatment effectiveness of various biochar-amended BSM mixtures. Real stormwater will be used for the column tests to account for the effect of influent water quality on load removal. The goal of this task is to identify BSM mixtures amended with biochar that meet operational infiltration requirements and are effective for PCBs and mercury removal for future field testing.

All monitoring results and interpretations will be documented in BASMAA reports for submission to the Regional Water Board according to the schedule in the MRP.

4.2. Sampling Detail

The Monitoring Program includes three separate sampling tasks that involve collection and analysis of the following types of samples: caulk/sealants (Task 1); sediment from HDS units (Task 2); and stormwater collected and used for column tests in the lab (Task 3). Additional details specific to the sampling design for each task are provided below.

4.2.1. Task 1 - Caulk/Sealant samples

The PMT will recruit municipal partners from within each stormwater program to participate in this task. All caulk/sealant samples will be collected from locations within public roadway or storm drain infrastructure in the participating municipalities. Exact sample sites will be identified based on available information for each municipal partner, including: age of public infrastructure; records of infrastructure repair or rehabilitation (aiming for the late 1960s through the 1970s); and current municipal staff knowledge about locations that meet the site selection criteria identified in the study design (BASMAA, 2017a). Field crews led by the Field-PM and/or municipal staff will conduct field reconnaissance to further identify specific sampling locations and if feasible, will collect caulk/sealant samples during these initial field visits. Follow-up sampling events will be conducted for any sites that require additional planning or equipment for sample collection (e.g., confined space entry, parking controls, etc.). Sample locations will include any of the following public infrastructure where caulk/sealant are present: roadway or sidewalk surfaces, between expansion joints for roadways, parking garages, bridges, dams, or storm drain pipes, and/or in pavement joints (e.g., curb and gutter). Sampling will only occur during periods of dry weather when urban runoff flows through any structures that will be sampled are minimal, and do not

present any safety hazards or other logistical issues during sample collection. Sample collection methods are described further in Section 9.

As opportunities arise, municipal staff will also collect samples following the methods and procedures described in this SAP/QAPP during ongoing capital projects that provide access to public infrastructure locations with caulk/sealant that meet the sample site criteria. All samples collected by participating municipal staff will be delivered to the Field PM under COC. The Field-PM will be responsible for storing all caulk/sealant samples and shipping the samples under COC to CEH for XRF screening analysis.

All caulk/sealant samples collected will be screened for chlorine content using XRF technology described in Section 9. Samples will be grouped for compositing purposes as described in the study design (BASMAA, 2017a). Up to three samples will be included per composite and a total of 20 composite caulk/sealant samples will be analyzed for the RMP 40 PCB congeners¹. All compositing and PCBs analysis will be conducted blind to the location where each sample was collected. Laboratory analysis methods must be able to detect a minimum PCBs concentration of 200 parts per billion (ppb, or $\mu\text{g}/\text{Kg}$). Laboratory analytical methods are described further in Section 12. The range of PCB concentrations found in caulk based on this documented sampling design will be reported to the Regional Water Board within the Permittees' 2018 Annual Reports.

4.2.2.Task 2 - Sediment samples from HDS Units

The PMT will recruit municipal partners that maintain public HDS units to participate in this task. All sediment samples will be collected from the sump of selected HDS units during scheduled cleaning and maintenance. Selection of the HDS units for sampling will be opportunistic, based on the units that are scheduled for maintenance by participating municipalities during the project period. Field crews led by the Field-PM and municipal maintenance staff will coordinate sampling with scheduled maintenance events. As needed, municipal staff will dewater the HDS unit sumps prior to sample collection, and provide assistance to field crews with access to the sump sediment as needed (e.g., confined space entry, parking controls, etc.). All sump sediment samples will be collected following the methods and procedures described in this SAP/QAPP. Sampling will only occur during periods of dry weather when urban runoff flows into the HDS unit sumps are minimal, and do not present any safety hazards or other logistical issues during sample collection. Sample collection methods are described further in Section 9.

All sediment samples collected will be analyzed for the RMP 40 PCB congeners, total mercury, total organic carbon (TOC), particle size distribution (PSD), and bulk density. Laboratory analytical methods are described further in Section 12. The range of PCB and mercury concentrations observed in HDS Unit sump sediments and the annual pollutant masses removed during cleanouts will be reported to the Regional Water Board in March 2019.

4.2.3.Task 3 - Storm Water and Column Test Samples

This task will collect stormwater from Bay Area locations that will then be used as the influent for column tests of biochar-amended BSM. Bay Area stormwater samples will be collected from locations

¹ The 40 individual congeners routinely quantified by the Regional Monitoring Program (RMP) for Water Quality in the San Francisco Estuary include: PCBs 8, 18, 28, 31, 33, 44, 49, 52, 56, 60, 66, 70, 74, 87, 95, 97, 99, 101, 105, 110, 118, 128, 132, 138, 141, 149, 151, 153, 156, 158, 170, 174, 177, 180, 183, 187, 194, 195, 201, and 203

within public roadway or storm drain infrastructure in participating municipalities. Field personnel lead by the Field PM will collect stormwater samples during three qualifying storm events and ensure all samples are delivered to the lab of OWP at CSUS within 24-hours of collection. Stormwater will be collected from one watershed that has a range of PCB concentrations and is considered representative of Bay Area watersheds (e.g. the West Oakland Ettie Street Pump Station watershed). Storms from the representative watershed should be targeted randomly without bias, thereby accounting for the effects of storm intensity and ensuring variability in contaminant concentration, proportion of dissolved contaminants, particle size, particle size distribution, and particle density. To achieve this, minimal mobilization criteria should be used to ensure predicted storm intensity and runoff volume are likely to yield the desired volume. Sample collection methods are described further in Section 9.

The stormwater collected will be used as the influent for column tests of various BSM mixtures amended with biochar. These tests will be implemented in three phases. First, hydraulic screening tests will be performed to ensure all amended BSM mixtures meet the MRP infiltration rate requirements of 12 in/h initial maximum infiltration or minimum 5 in/h long-term infiltration rate. Second, column tests will be performed using Bay Area stormwater to evaluate pollutant removal. Third, additional column tests will be performed using lower concentration (e.g., diluted) Bay Area stormwater to evaluate relative pollutant removal performance at lower concentrations. Further details about the column testing are provided in Section 9.3.

All influent and effluent water samples collected will be analyzed for the RMP 40 PCB congeners, total mercury, suspended sediment concentrations (SSC), TOC, and turbidity. Laboratory analytical methods are described further in Section 12. The range of PCB and mercury concentrations observed in influent and effluent water samples and the associated pollutant mass removal efficiencies for each BSM mixture tested will be reported to the Regional Water Board in March 2019.

4.3. Schedule

Caulk/sealant sampling (Task 1) will be conducted between July 2017 and December 2017. HDS Unit sampling (Task 2) will be conducted between July 2017 and May 2018. Stormwater sample collection and BSM column tests (Task 3) will occur between October 2017 – April 2018.

4.4. Geographical Setting

Field operations will be conducted across multiple Phase I cities in the San Francisco Bay region within the counties of San Mateo, Santa Clara, Alameda, and Contra Costa, and the City of Vallejo.

4.5. Constraints

Caulk/sealant sampling and HDS unit sampling will only be conducted during dry weather, when urban runoff flows through the sampled structures are minimal and do not present safety hazards or other logistical concerns. Caulk/sealant sampling will be limited to the caulk/sealant available and accessible at sites that meet the project site criteria (described in the Study Design, BASMAA 2017a). HDS unit sampling will be limited by the number of public HDS units that are available for maintenance during the project period. Extreme wet weather may pose a safety hazard to sampling personnel and may therefore impact wet season sampling.

5. Measurement Quality Objectives (MQO)

The quantitative measurements that estimate the true value or concentration of a physical or chemical property always involve some level of uncertainty. The uncertainty associated with a measurement generally results from one or more of several areas: (1) natural variability of a sample; (2) sample handling conditions and operations; (3) spatial and temporal variation; and (4) variations in collection or analytical procedures. Stringent Quality Assurance (QA) and Quality Control (QC) procedures are essential for obtaining unbiased, precise, and representative measurements and for maintaining the integrity of the sample during collection, handling, and analysis, as well as for measuring elements of variability that cannot be controlled. Stringent procedures also must be applied to data management to assure that accuracy of the data is maintained.

MQOs are established to ensure that data collected are sufficient and of adequate quality for the intended use. MQOs include both quantitative and qualitative assessment of the acceptability of data. The qualitative goals include representativeness and comparability, and the quantitative goals include completeness, sensitivity (detection and quantization limits), precision, accuracy, and contamination.

MQOs associated with representativeness, comparability, completeness, sensitivity, precision, accuracy, and contamination are presented below in narrative form.

5.1. Representativeness and Comparability

The representativeness of data is the ability of the sampling locations and the sampling procedures to adequately represent the true condition of the sample sites. The comparability of data is the degree to which the data can be compared directly between all samples collected under this SAP/QAPP. Field personnel, including municipal personnel that collect samples, will strictly adhere to the field sampling protocols identified in this SAP/QAPP to ensure the collection of representative, uncontaminated, comparable samples. The most important aspects of quality control associated with chemistry sample collection are as follows:

- Field personnel will be thoroughly trained in the proper use of sample collection equipment and will be able to distinguish acceptable versus unacceptable samples in accordance with pre-established criteria.
- Field personnel are trained to recognize and avoid potential sources of sample contamination (e.g., dirty hands, insufficient field cleaning).
- Samplers and utensils that come in direct contact with the sample will be made of non-contaminating materials, and will be thoroughly cleaned between sampling stations.
- Sample containers will be pre-cleaned and of the recommended type.
- All sampling sites will be selected according to the criteria identified in the project study design (BASMAA, 2017a)

Further, the methods for collecting and analyzing PCBs in infrastructure caulk and sealants will be comparable to other studies of PCBs in building material and infrastructure caulk (e.g., Klosterhaus et al., 2014). This SAP/QAPP was also developed to be comparable with the California Surface Water Ambient Monitoring Program (SWAMP) Quality Assurance Program Plan (QAPrP, SWAMP 2013). All sediment

and water quality data collected during the Monitoring Program will be performed in a manner so that data are SWAMP comparable².

5.2. Completeness

Completeness is defined as the percentage of valid data collected and analyzed compared to the total expected to be obtained under normal operating conditions. Overall completeness accounts for both sampling (in the field) and analysis (in the laboratory). Valid samples include those for analytes in which the concentration is determined to be below detection limits.

Under ideal circumstances, the objective is to collect 100 percent of all field samples desired, with successful laboratory analyses on 100% of measurements (including QC samples). However, circumstances surrounding sample collections and subsequent laboratory analysis are influenced by numerous factors, including availability of infrastructure meeting the required sampling criteria (applies to both infrastructure caulk sampling and HDS Unit sampling), flow conditions, weather, shipping damage or delays, sampling crew or lab analyst error, and QC samples failing MQOs. An overall completeness of greater than 90% is considered acceptable for the Monitoring Program.

5.3. Sensitivity

Different indicators of the sensitivity of an analytical method to measure a target parameter are often used including instrument detection limits (IDLs), method detection limits (MDLs), and method reporting limits (MRLs). For the Monitoring Program, MRL is the measurement of primary interest, consistent with SWAMP Quality Assurance Project Plan (SWAMP 2013). Target MRLs for all analytes by analytical method provided in Section 13.

5.4. Precision

Precision is used to measure the degree of mutual agreement among individual measurements of the same property under prescribed similar conditions. Overall precision usually refers to the degree of agreement for the entire sampling, operational, and analysis system. It is derived from reanalysis of individual samples (laboratory replicates) or multiple collocated samples (field replicates) analyzed on equivalent instruments and expressed as the relative percent difference (RPD) or relative standard deviation (RSD). Analytical precision can be determined from duplicate analyses of field samples, laboratory matrix spikes/matrix spike duplicates (MS/MSD), laboratory control samples (LCS) and/or reference material samples. Analytical precision is expressed as the RPD for duplicate measurements:

$$RPD = \text{ABS} ([X1 - X2] / [(X1 + X2) / 2])$$

Where: X1 = the first sample result
X2 = the duplicate sample result.

² SWAMP data templates and documentation are available online at
http://waterboards.ca.gov/water_issues/programs/swamp/data_management_resources/templates_docs.shtml

Precision will be assessed during the Monitoring Program by calculating the RPD of laboratory replicate samples and/or MS/MSD samples, which will be run at a frequency of 1 per analytical batch for each analyte. Target RPDs for the Monitoring Program are identified in Section 13.

5.5. Accuracy

Accuracy describes the degree of agreement between a measurement (or the average of measurements of the same quantity) and its true environmental value, or an acceptable reference value. The “true” values of the POCs in the Monitoring Program are unknown and therefore “absolute” accuracy (and representativeness) cannot be assessed. However, the analytical accuracy can be assessed through the use of laboratory MS samples, and/or LCS. For MS samples, recovery is calculated from the original sample result, the expected value (EV = native + spike concentration), and the measured value with the spike (MV):

$$\% \text{ Recovery} = (MV - N) \times 100\% / (EV - N)$$

Where: MV = the measured value
EV = the true expected (reference) value
N = the native, unspiked result

For LCS, recovery is calculated from the concentration of the analyte recovered and the true value of the amount spiked:

$$\% \text{ Recovery} = (X / TV) \times 100\%$$

Where: X = concentration of the analyte recovered
TV = concentration of the true value of the amount spiked

Surrogate standards are also spiked into samples for some analytical methods (i.e., PCBs) and used to evaluate method and instrument performance. Although recoveries on surrogates are to be reported, control limits for surrogates are method and laboratory specific, and no project specific recovery targets for surrogates are specified, so long as overall recovery targets for accuracy (with matrix spikes) are achieved. Where surrogate recoveries are applicable, data will not be reported as surrogate-corrected values.

Analytical accuracy will be assessed during the Monitoring Program based on recovery of the compound of interest in matrix spike and matrix spike duplicates compared with the laboratory’s expected value, at a frequency of 1 per analytical batch for each analyte. Recovery targets for the Monitoring Program are identified in Section 13.

5.6. Contamination

Collected samples may inadvertently be contaminated with target analytes at many points in the sampling and analytical process, from the materials shipped for field sampling, to the air supply in the analytical laboratory. When appropriate, blank samples evaluated at multiple points in the process chain help assure that compound of interest measured in samples actually originated from the target matrix in the sampled environment and are not artifacts of the collection or analytical process.

Method blanks (also called laboratory reagent blanks, extraction blanks, procedural blanks, or preparation blanks) are used by laboratory personnel to assess laboratory contamination during all stages of sample preparation and analysis. The method blank is processed through the entire analytical procedure in a manner identical to the samples. A method blank concentration should be less than the RL or should not exceed a concentration of 10% of the lowest reported sample concentration. A method blank concentration greater than 10% of the lowest reported sample concentration will require corrective action to identify and eliminate the source(s) of contamination before proceeding with sample analysis. If eliminating the blank contamination is not possible, all impacted analytes in the analytical batch shall be flagged. In addition, a detailed description of the likely contamination source(s) and the steps taken to eliminate/minimize the contaminants shall be included in narrative of the data report. If supporting data is presented demonstrating sufficient precision in blank measurement that the 99% confidence interval around the average blank value is less than the MDL or 10% of the lowest measured sample concentration, then the average blank value may be subtracted.

A field blank is collected to assess potential sample contamination levels that occur during field sampling activities. Field blanks are taken to the field, transferred to the appropriate container, preserved (if required by the method), and treated the same as the corresponding sample type during the course of a sampling event. The inclusion of field blanks is dependent on the requirements specified in the relevant MQO tables or in the sampling method.

6. Special Training Needs / Certification

All fieldwork will be performed by contractor staff that has appropriate levels of experience and expertise to conduct the work, and/or by municipal staff that have received the appropriate instruction on sample collection, as determined by the Field PM and/or the PMT. The Field-PM will ensure that all members of the field crew (including participating municipal staff) have received appropriate instructions based on methods described in this document (Section 9) for collecting and transporting samples. As appropriate, sampling personnel may be required to undergo or have undergone OSHA training / certification for confined space entry in order to undertake particular aspects of sampling within areas deemed as such.

Analytical laboratories are to be certified for the analyses conducted at each laboratory by ELAP, NELAP, or an equivalent accreditation program as approved by the PMT. All laboratory personal will follow methods described in Section 13 for analyzing samples.

7. Program Documentation and Reporting

The Consultant Team in consultation with the PMT will prepare draft and final reports of all monitoring data, including statistical analysis and interpretation of the data, as appropriate, which will be submitted to the BASMAA BOD for approval. Following approval by the BASMAA BOD, Final project reports will be available for submission with each stormwater program's Annual Report in 2018 (Task 1) or in the March 31, 2019 report to the Regional Water Board (Tasks 2 and 3). Procedures for overall management of project documents and records and report preparation are summarized below.

7.1. Field Documentation

All field data gathered for the project are to be recorded in field datasheets, and scanned or transcribed to electronic documents as needed to permit easy access by the PMT, the consultant team, and other appropriate parties.

7.1.1. Sampling Plans, COCs, and Sampling Reports

The Field-PM will be responsible for development and submission of field sampling reports to the Data Manager and Consultant-PM. Field crews will collect records for sample collection, and will be responsible for maintaining these records in an accessible manner. Samples sent to analytical laboratories will include standard Chain of Custody (COC) procedures and forms; field crews will maintain a copy of originating COCs at their individual headquarters. Analytical laboratories will collect records for sample receipt and storage, analyses, and reporting. All records, except lab records, generated by the Monitoring Program will be stored at the office of the Data Manager for the duration of the project, and provided to BASMAA at the end of the project.

7.1.2. Data Sheets

All field data gathered by the Monitoring Program will be recorded on standardized field data entry forms. The field data sheets that will be used for each sampling task are provided in Appendix A.

7.1.3. Photographic Documentation

Photographic documentation is an important part of sampling procedures. An associated photo log will be maintained documenting sites and subjects associated with photos. If an option, the date function on the camera shall be turned on. Field Personnel will be instructed to take care to avoid any land marks when taking photographs, such as street signs, names of buildings, road mile markers, etc. that could be used later to identify a specific location. A copy of all photographs should be provided at the conclusion of sampling efforts and maintained for project duration.

7.2. Laboratory Documentation

The Monitoring Program requires specific actions to be taken by contract laboratories, including requirements for data deliverables, quality control, and on-site archival of project-specific information. Each of these aspects is described below.

7.2.1. Data Reporting Format

Each laboratory will deliver data in electronic formats to the Field-PM, who will transfer the records to the Data Manager, who is responsible for storage and safekeeping of these records for the duration of the project. In addition, each laboratory will deliver narrative information to the QA Officer for use in data QA and for long-term storage.

The analytical laboratory will report the analytical data to the Field-PM via an analytical report consisting of, at a minimum:

1. Letter of transmittal
2. Chain of custody information
3. Analytical results for field and quality control samples (Electronic Data Deliverable, EDD)
4. Case narrative

5. Copies of all raw data.

The Field-PM will review the data deliverables provided by the laboratory for completeness and errors. The QA Officer will review the data deliverables provided by the laboratory for review of QA/QC. In addition to the laboratory's standard reporting format, all results meeting MQOs and results having satisfactory explanations for deviations from objectives shall be reported in tabular format on electronic media. SWAMP-formatted electronic data deliverable (EDD) templates are to be agreed upon by the Data Manager, QA Officer, and the Lab-PM prior to onset of any sampling activities related to that laboratory.

Documentation for analytical data is kept on file at the laboratories, or may be submitted with analytical results. These may be reviewed during external audits of the Monitoring Program, as needed. These records include the analyst's comments on the condition of the sample and progress of the analysis, raw data, and QC checks. Paper or electronic copies of all analytical data, field data forms and field notebooks, raw and condensed data for analysis performed on-site, and field instrument calibration notebooks are kept as part of the Monitoring Program archives for a minimum period of eight years.

7.2.2. Other Laboratory QA/QC Documentation

All laboratories will have the latest version of this Monitoring Program SAP/QAPP in electronic format. In addition, the following documents and information from the laboratories will be current, and they will be available to all laboratory personnel participating in the processing of samples:

1. Laboratory QA plan: Clearly defines policies and protocols specific to a particular laboratory, including personnel responsibilities, laboratory acceptance criteria, and corrective actions to be applied to the affected analytical batches, qualification of data, and procedures for determining the acceptability of results.
2. Laboratory Standard Operation Procedures (SOPs): Contain instructions for performing routine laboratory procedures, describing exactly how a method is implemented in the laboratory for a particular analytical procedure. Where published standard methods allow alternatives at various steps in the process, those approaches chosen by the laboratory in their implementation (either in general or in specific analytical batches) are to be noted in the data report, and any deviations from the standard method are to be noted and described.
3. Instrument performance information: Contains information on instrument baseline noise, calibration standard response, analytical precision and bias data, detection limits, scheduled maintenance, etc.
4. Control charts: Control charts are developed and maintained throughout the Program for all appropriate analyses and measurements for purposes of determining sources of an analytical problem or in monitoring an unstable process subject to drift. Control charts serve as internal evaluations of laboratory procedures and methodology and are helpful in identifying and correcting systematic error sources. Control limits for the laboratory quality control samples are ± 3 standard deviations from the certified or theoretical concentration for any given analyte.

Records of all quality control data, maintained in a bound notebook at each workstation, are signed and dated by the analyst. Quality control data include documentation of standard calibrations, instrument

maintenance and tests. Control charts of the data are generated by the analysts monthly or for analyses done infrequently, with each analysis batch. The laboratory quality assurance specialist will review all QA/QC records with each data submission, and will provide QA/QC reports to the Field-PM with each batch of submitted field sample data.

7.3. Program Management Documentation

The BASMAA-PM and Consultant-PM are responsible for managing key parts of the Monitoring Program’s information management systems. These efforts are described below.

7.3.1.SAP/QAPP

All original SAP/QAPPs will be held by the Consultant-PM. This SAP/QAPP and its revisions will be distributed to all parties involved with the Monitoring Program. Copies will also be sent to the each participating analytical laboratory's contact for internal distribution, preferably via electronic distribution from a secure location.

Associated with each update to the SAP/QAPP, the Consultant-PM will notify the BASMAA-PM and the PMT of the updated SAP/QAPP, with a cover memo compiling changes made. After appropriate distributions are made to affected parties, these approved updates will be filed and maintained by the SAP/QAPP Preparers for the Monitoring Program. Upon revision, the replaced SAP/QAPPs will be discarded/deleted.

7.3.2.Program Information Archival

The Data Manager and Consultant-PM will oversee the actions of all personnel with records retention responsibilities, and will arbitrate any issues relative to records retention and any decisions to discard records. Each analytical laboratory will archive all analytical records generated for this Program. The Consultant-PM will be responsible for archiving all management-level records.

Persons responsible for maintaining records for this Program are shown in Table 7-1.

Table 7-1. Document and Record Retention, Archival, and Disposition

Type	Retention (years)	Archival	Disposition
Field Datasheets	8	Data Manager	Maintain indefinitely
Chain of Custody Forms	8	Data Manager	Maintain indefinitely
Raw Analytical Data	8	Laboratory	Recycling
Lab QC Records	8	Laboratory	Recycling
Electronic data deliverables	8	Data Manager	Maintain indefinitely
Reports	8	Consultant-PM	Maintain indefinitely

As discussed previously, the analytical laboratory will archive all analytical records generated for this Program. The Consultant-PM will be responsible for archiving all other records associated with implementation of the Monitoring Program.

All field operation records will be entered into electronic formats and maintained in a dedicated directory managed by the BASMAA-PM.

7.4. Reporting

The Consultant team will prepare draft and final reports for each component of the Monitoring Program. The PMT will provide review and input on draft reports and submit to the BASMAA BOD for approval. Once approved by the BASMAA BOD, the Monitoring Program reports will be available to each individual stormwater program for submission to the Regional Water Board according to the schedule outlined in the MRP and summarized in Table 7.2.

Table 7-2. Monitoring Program Final Reporting Due Dates.

Monitoring Program Component	Task	MRP Reporting Due Date
Source Identification	Task 1 - Evaluation of PCB concentrations in roadway and storm drain infrastructure caulk and sealants	September 30, 2018
Management Action Effectiveness	Task 2 - Evaluation of the annual mass of PCBs and mercury captured in HDS Unit sump sediment	March 31, 2019
	Task 3 - Bench-scale testing of the mercury and PCBs removal effectiveness of selected BSM mixtures.	

8. Sampling Process Design

All information generated through conduct of the Monitoring Program will be used to inform TMDL implementation efforts for mercury and PCBs in the San Francisco Bay region. The Monitoring Program will implement the following tasks: (1) evaluate the presence and concentrations of PCB in caulk and sealants from public roadway and stormdrain infrastructure; (2) evaluate mass of PCBs and mercury removed during HDS Unit maintenance; and (3) evaluate the mercury and PCBs treatment effectiveness of various BSM mixtures in laboratory column tests using stormwater collected from Bay Area locations. Sample locations and the timing of sample collection will be selected using the directed sampling design principle. This is a deterministic approach in which points are selected deliberately based on knowledge of their attributes of interest as related to the environmental site being monitored. This principle is also known as "judgmental," "authoritative," "targeted," or "knowledge-based." Individual monitoring aspects are summarized further under Field Methods (Section 9) and in the task-specific study designs (BASMAA 2017a,b).

8.1. Caulk/Sealant Sampling

Caulk/sealant sampling will support the Monitoring Program's Task 1 to evaluate PCBs in roadway and stormdrain infrastructure caulk/sealant, as described previously (see Section 4). Further detail on caulk/sealant sampling methods and procedures are provided under Field Methods (Section 9).

8.2. Sediment Quality Sampling

Sediment sampling will support the Monitoring Program's Task 2 to evaluate the mass of mercury and PCBs removed during HDS unit maintenance, as described previously (see Section 4). Further detail on

sediment sampling methods and procedures are provided under Field Methods (Section 9).

8.3. Water Quality Sampling

Water sampling will support the Monitoring Program's Task 3 to evaluate the mercury and PCBs treatment effectiveness of various BSM mixtures, as described previously (see Section 4). Further detail on water sampling methods and procedures are provided under Field Methods (Section 9).

8.4. Sampling Uncertainty

There are multiple sources of potential sampling uncertainty associated with the Monitoring Program, including: (1) measurement error; (2) natural (inherent) variability; (3) undersampling (or poor representativeness); and (4) sampling bias (statistical meaning). Measures incorporated to address these areas of uncertainty are discussed below:

(1) Measurement error combines all sources of error related to the entire sampling and analysis process (i.e., to the measurement system). All aspects of dealing with uncertainty due to measurement error have been described elsewhere within this document.

(2) Natural (inherent) variability occurs in any environment monitored, and is often much wider than the measurement error. Prior work conducted by others in the field of stormwater management have demonstrated the high degree of variability in environmental media, which will be taken into consideration when interpreting results of the various lines of inquiry.

(3) Under- or unrepresentative sampling happens at the level of an individual sample or field measurement where an individual sample collected is a poor representative for overall conditions encountered given typical sources of variation. To address this situation, the Monitoring Program will be implementing a number of QA-related measures described elsewhere within this document, including methods refined through implementation of prior, related investigations.

(4) Sampling bias relates to the sampling design employed and whether the appropriate statistical design is employed to allow for appropriate understanding of environmental conditions. To a large degree, the sampling design required by the Monitoring Program is judgmental, which will therefore incorporate an unknown degree of sampling bias into the Project. There are small measures that have been built into the sampling design to combat this effect (e.g., homogenization of sediments for chemistry analyses), but overall this bias is a desired outcome designed to meet the goals of this Monitoring Program, and will be taken into consideration when interpreting results of the various investigations.

Further detail on measures implemented to reduce uncertainty through mobilization, sampling, sample handling, analysis, and reporting phases are provided throughout this document.

9. Sampling Methods

The Monitoring Program involves the collection of three types of samples: Caulk/sealants; sediment from HDS unit sumps; and water quality samples. Field collection will be conducted by field contractors or municipal staff using a variety of sampling protocols, depending on the media and parameter monitored. These methods are presented below. In addition, the Monitoring Program will utilize several field

sampling SOPs previously developed by the BASMAA Regional Monitoring Coalition identified in Table 9-3 (RMC, BASMAA, 2016).

9.1. Caulk/Sealant Sampling (Task 1)

Procedures for collecting caulk and sealant samples are not well established. Minimal details on caulk or sealant sample collection methodologies are available in peer-reviewed publications. The caulk/sealant sampling procedures described here were adapted from a previous study examining PCBs in building materials conducted in the Bay Area (Klosterhaus et al., 2014). The methods described by Klosterhaus et al. (2014) were developed through consultation with many of the previous authors of caulk literature references therein, in addition to field experience gained during the Bay Area study. It is anticipated that lessons will also be learned during the current study.

9.1.1. Sample Site Selection

Once a structure has been identified as meeting the selection criteria and permission is granted to perform the testing or collection of sealant samples, an on-site survey of the structure will be used to identify sealant types and locations on the structure to be sampled. It is expected that sealants from a number of different locations on each structure may be sampled; however, inconspicuous locations on the structure will be targeted.

9.1.2. Initial Equipment Cleaning

The sampling equipment that is pre-cleaned includes:

- Glass sample jars
- Utility knife, extra blades
- Stainless-steel forceps

Prior to sampling, all equipment will be thoroughly cleaned. Glass sample containers will be factory pre-cleaned (Quality Certified™, ESS Vial, Oakland, CA) and delivered to field team at least one week prior to the start of sample collection. Sample containers will be pre-labeled and kept in their original boxes, which will be transported in coolers. Utility knife blades, forceps, stainless steel spoons, and chisels will be pre-cleaned with Alconox, Liquinox, or similar detergent, and then rinsed with deionized water and methanol. The cleaned equipment will then be wrapped in methanol-rinsed aluminum foil and stored in clean Ziploc bags until used in the field.

9.1.3. Field Cleaning Protocol

Between each use the tool used (utility knife blade, spoon or chisel) and forceps will be rinsed with methanol and then deionized water, and inspected to ensure all visible sign of the previous sample have been removed. The clean tools, extra blades, and forceps will be kept in methanol-rinsed aluminum foil and stored in clean Ziploc bags when not in use.

9.1.4. Blind Sampling Procedures

The intention of this sampling is to better determine whether sealants in road and storm drain infrastructure contain PCBs at concentrations of concern, and to understand the relative importance of PCBs in this infrastructure among the other known sources of PCBs that can affect San Francisco Bay. At this phase of the project, we are not seeking to identify specific facilities requiring mitigation (if PCBs are

identified, this could be a future phase). Therefore, in this initial round of sampling, we are not identifying sample locations, but instead implementing a blind sampling protocol, as follows:

- All samples will be collected without retaining any information that would identify structure locations. The information provided to the contractor on sampling locations will not be retained. Structure location information will not be recorded on any data sheets or in any data spreadsheets or other electronic computer files created for the Project. Physical sealant samples collected will be identified only by a sample identification (ID) designation (Section 4). Physical sealant sample labels will contain only the sample ID (see Section 4 and example label in Appendix A). Samples will be identified only by their sample ID on the COC forms.
- As an added precaution and if resources allow, oversampling will occur such that more samples will be collected than will be sent to the laboratory for compositing and analysis. In this case, the Project team would select a subset of samples for PCB analysis based on factors such as application type and/or chlorine content, but blind to the specific location where each sample was collected.
- Up to three individual sealant samples will be composited by the laboratory prior to analysis for PCBs, following instructions from the Consultant PM. This further ensures a blind sampling approach because samples collected at different locations will be analyzed together.

9.1.5.Caulk/Sealant Collection Procedures

At each sample location, the Field-PM, and/or municipal staff, will make a final selection of the most accessible sampling points at the time of sampling. From each point sampled, a one inch strip (aiming for about 10 g of material) of caulk or sealant will be removed from the structure using one of the following solvent-rinsed tools: a utility knife with a stainless-steel blade, stainless steel spoon to scrape off the material, or a stainless steel chisel. The Field-PM or municipal staff at the site will select the appropriate tool based on the conditions of the caulk/sealant at each sample point. Field personnel will wear nitrile gloves during sample collection to reduce potential sample contamination. The sample will then be placed in a labeled, factory-cleaned glass jar. For each caulk sample collected, field personnel will fill out a field data sheet at the time of sample collection, which includes the following information:

- Date and time of sample collection,
- sample identification designation,
- qualitative descriptions of relevant structure or caulk/sealant features, including use profile, color and consistency of material collected, surface coating (paint, oily film, masonry residues etc.)
- crack dimensions, the length and/or width of the caulk bead sampled, spacing of expansion joints in a particular type of application, and
- a description of any unusual occurrences associated with the sampling event (especially those that could affect sample or data quality).

Appendix A contains an example field data sheet. All samples will be kept in a chilled cooler in the field (i.e., at $4\text{ }^{\circ}\text{C} \pm 2\text{ }^{\circ}\text{C}$), and kept refrigerated pending delivery under COC to the Field PM at KLI. Further, the field data sheets will remain with the samples when they are shipped to KLI, and will then be maintained by the Field PM at KLI.

As needed, the procedure for replacement of the caulk/sealant will be coordinated with the appropriate municipal staff to help ensure that the sampling does not result in damage to the structure.

9.1.6. Sample ID Designation

Every sample must have a unique sample ID to ensure analytical results from each sample can be differentiated from every other sample. This information should follow the sample through the COC, analytical, and interpretation and reporting processes. For the infrastructure caulk/sealant samples, the sample ID must not contain information that can be used to identify where the sample was collected. The following 2-step process will be followed to assign sample IDs to the caulk/sealant samples.

1. Upon collection, the sample will be labeled according to the following naming convention:

MMDDYYYY-TTTT-##

Where:

MM	2 digit month of collection
DD	2 digit date of collection
YYYY	4 digit year of collection
TTTT	4 digit time of collection (military time)
##	Sequential 2-digit sample number (i.e., 01, 02, 03...etc.)

For example, a sample collected on September 20, 2017 at 9 AM could be assigned the following sample ID: 09202017-0900-01.

2. This second step was added to avoid issues that could arise due to duplicate sample IDs, while maintaining the blind sampling approach. While the sample naming system identified above is unlikely to produce duplicate sample IDs, there is a chance that different groups may collect samples simultaneously. This second step will be implemented by the Field PM at KLI upon receipt of caulk/sealant samples from participating municipalities. The Field PM at KLI will review the sample IDs on the COC forms for all samples and compare the sample IDs to all caulk samples for this project already in storage at KLI. If any two samples have the same sample IDs, the Field PM will add a one-digit number to the end of one of the sample IDs, selected at random. This extra number will be added to the sample container label, the field data sheet, and the COC form for that sample.

9.2. HDS Unit Sampling Procedures (Task 2)

9.2.1. Sample Site Selection

Sample site selection will be opportunistic, based on the public HDS units that participating municipalities schedule for cleaning during the project. The project team will coordinate with participating municipalities to schedule sampling during HDS unit cleanouts.

9.2.2. Field Equipment and Cleaning

A list of potential sampling equipment for soil/sediment is presented in Table 5. The equipment list should be reviewed and tailored by field contractors to meet the needs of each individual sampling site. Appropriate sampling equipment is prepared in the laboratory a minimum of four days prior to sampling. Prior to sampling, all equipment will be thoroughly cleaned. Equipment is soaked (fully immersed) for three days in a solution of Alconox, Liquinox, or similar phosphate-free detergent and deionized water. Equipment is then rinsed three times with deionized water. Equipment is next rinsed with a dilute solution

(1-2%) of hydrochloric acid, followed by a rinse with reagent grade methanol, followed by another set of three rinses with deionized water. All equipment is then allowed to dry in a clean place. The cleaned equipment is then wrapped in aluminum foil or stored in clean Ziploc bags until used in the field.

Table 9-1 Field Equipment for HDS Unit Sampling.

Description of Equipment	Material (if applicable)
Sample scoops	Stainless steel or Kynar coated
Sample trowels	Stainless steel or Kynar coated
Compositing bucket	Stainless steel or Kynar coated
Ekman Dredge (as needed)	Stainless steel
Sample containers (with labels)	As coordinated with lab(s)
Methanol, Reagent grade (Teflon squeeze bottle with refill)	
Hydrochloric acid, 1-2%, Reagent grade (Teflon squeeze bottle)	
Liquinox detergent (diluted in DI within Teflon squeeze bottle)	
Deionized / reverse osmosis water	
Plastic scrub brushes	
Container for storage of sampling derived waste, dry	
Container for storage of sampling derived waste, wet	
Wet ice	
Coolers, as required	
Aluminum foil (heavy duty recommended)	
Protective packaging materials	Bubble / foam bags
Splash proof eye protection	
PPE for sampling personnel, including traffic mgmt as required	
Gloves for dry ice handling	Cotton, leather, etc.
Gloves for sample collection, reagent handling	Nitrile
Field datasheets	
COC forms	
Custody tape (as required)	
Shipping materials (as required)	
GPS	

9.2.3. Soil / Sediment Sample Collection

Field sampling personnel will collect sediment samples from HDS unit sumps using methods that minimize contamination, losses, and changes to the chemical form of the analytes of interest. The samples will be collected in the field into pre-cleaned sample containers of a material appropriate to the analysis to be conducted. Pre-cleaned sampling equipment is used for each site, whenever possible and/or when necessary. Appropriate sampling technique and measuring equipment may vary depending on the location, sample type, sampling objective, and weather. Additional safety measures may be necessary in some cases; for example, if traffic control or confined space entry is required to conduct the sampling.

Ideally and where a sufficient volume of soil/sediment allows, samples are collected into a composite container, where they are thoroughly homogenized, and then aliquoted into separate jars for chemical analysis. Sediment samples for metals and organics are submitted to the analytical laboratories in separate jars, which have been pre-cleaned according to laboratory protocol. It is anticipated that soil / solid media will be collected for laboratory analysis using one of two techniques: (1) Remote grab of submerged sediments within HDS unit sumps using Ekman dredge or similar; or (2) direct grab sampling of

sediments after dewatering HDS unit sumps using individual scoops, push core sampling, or similar. Each of these techniques is described briefly below.

- **Soil and Sediment Samples, Submerged.** Wet soil and sediment samples may be collected from within HDS unit sumps. Sample crews must exercise judgment on whether submerged samples can be collected in a manner that does not substantially change the character of the soil/sediment collected for analysis (e.g., loss of fine materials). It is anticipated that presence of trash within the sumps may interfere with sample collection by preventing complete grab closure and loss of significant portion of the sample. Field crews will have the responsibility to determine the best method for collection of samples within each HDS Unit sump. If sampling personnel determine that sample integrity cannot be maintained throughout collection process, it is preferable to cancel sampling operations rather than collect samples with questionable integrity. This decision making process is more fully described in Section 11, Field Variances.
- **Soil and Sediment Samples, Dry.** Soils / sediments may be collected from within the HDS unit sump after dewatering. Field crews will have the responsibility to identify areas of sediment accumulation within areas targeted for sampling and analysis, and determine the best method for collection of samples with minimal disturbance to the sampling media.

After collection, all soil/sediment samples for PCBs and mercury analyses will be homogenized and transferred from the sample-dedicated homogenization pail into factory-supplied wide-mouth glass jars using a clean trowel or scoop. The samples will be transferred to coolers containing double-bagged wet ice and chilled to 6°C immediately upon collection.

For each sample collected, field personnel will fill out a field data sheet at the time of sample collection. Appendix A contains an example field data sheet. All samples will be kept in a chilled cooler in the field, and kept refrigerated pending delivery under COC to the field-PM. The Field PM will be responsible for sending the samples in a single batch to CEH for XRF analysis under COC. Following XRF analysis, CEH will deliver the samples under COC to the Consultant-PM. The Consultant-PM will be responsible for working with the project team to group samples for compositing, and sending those samples to the analytical laboratory under COC.

9.2.4. Sample ID Designation

Every sample must have a unique sample ID so that the analytical results from each sample can be differentiated from every other sample. This information should follow the sample through the COC, analytical, and interpretation and reporting processes. Each sediment/soil sample collected from HDS units will be labeled according to the following naming convention:

MMM-UUU-##

where:

MMM	Municipal Abbreviation (i.e., SJC=San Jose; OAK=Oakland; SUN=Sunnyvale).
UUU	HDS Unit Catchment ID; this is the number provided by the municipality for a specific HDS unit.
##	Sequential Sample Number (i.e., 01, 02, 03...etc.)

9.3. Water Quality Sampling and Column Testing Procedures (Task 3)

For this task, monitoring will be conducted during three storm events. The stormwater collected during these events will then be used as the influent for the laboratory column tests of amended BSM mixtures. Four influent samples (i.e., one sample of Bay Area stormwater from each of the three monitored storm events plus one diluted stormwater sample) and 20 effluent samples from the column tests that includes 3 tests for each of the six columns, plus one test with the diluted stormwater in two columns (one test column and one control column) will be collected and analyzed for pollutant concentrations.

9.3.1. Sample Site Selection

Two stormwater collection sites have been selected based on influent PCB concentrations measured during CW4CB (BASMAA, 2017c). Both sites are near tree wells located on Ettie Street in West Oakland. The first site is the influent to tree well #6 (station code = TW6). During CW4CB, influent stormwater concentrations at this location were average to high, ranging from 30 ng/L to 286 ng/L. Stormwater collected from this site will be used as the influent for one of the main column tests and some water will be reserved for the dilution series column tests. The amount of dilution will be determined after results are received from the lab from the first run. The second site is the influent to tree well #2 (station code=TW2). During CW4CB, influent stormwater concentrations at this location were low to average, ranging from 6 ng/L to 39 ng/L. Stormwater collected from this site will be used for the remaining two main column tests..

9.3.2. Field Equipment and Cleaning

Field sampling equipment includes:

1. Borosilicate glass carboys
2. Glass sample jars
3. Peristaltic pump tubing

Prior to sampling, all equipment will be thoroughly cleaned. Glass sample containers and peristaltic pump tubing will be factory pre-cleaned. Prior to first use and after each use, glass carboys (field carboys and effluent collection carboys) will be washed using phosphate-free laboratory detergent and scrubbed with a plastic brush. After washing the carboy will be rinsed with methylene chloride, then de-ionized water, then 2N nitric acid, then again with de-ionized water. Glass carboys will be cleaned after each sample run before they are returned to the Field PM for reuse in the field.

9.3.3. Water Sampling Procedures

During each storm event, stormwater will be collected in six, five-gallon glass carboys. To fill the carboys, the Field PM will create a backwater condition in the gutter before the drain inlet at each site and use a peristaltic pump to pump the water into glass carboys. Field personnel will wear nitrile gloves during sample collection to prevent contamination. Carboys will be stored and transported in coolers with either wet ice or blue ice, and will be delivered to OWP within 24 hours of collection.

9.3.4. Hydraulic Testing

Based on the literature review and availability, the best five biochars will be mixed with the standard BSM to create biochar amended BSMs. Initially, each biochar will be mixed with standard BSM at a rate of 25% biochar by volume (the same as that at the CW4CB Richmond PG&E Substation 1st and Cutting

site). Hydraulic conductivity can be determined using the method stated in the BASMAA soil specification, method ASTM D2434.

1. Follow the directions for permeability testing in ASTM D2434 for the BSM.
2. Sieve enough of the sample biochar to collect at least 15 in³ on a no. 200 sieve.
3. Mix the sieved biochar with standard BSM at a 1 to 4 ratio.
4. Thoroughly mix the soil.
5. Follow the directions for permeability testing in ASTM D2434.
6. If the soil mix is more than 1 in/hr different from the BSM, repeat steps 1-4 but on step 3, adjust the ratio as estimated to achieve the same permeability as the BSM.
7. Repeat steps 2-6 for each biochar.

9.3.5. Column Testing Procedures

Column Setup: Up to five biochar amended BSMs and one standard BSM will be tested (based on performance and availability of biochars). Six glass columns with a diameter of eight inches and a height of three feet will be mounted to the wall with sufficient height between the bottom of the columns and the floor to allow for effluent sample collection. Each column will be capped at the bottom and fitted with a spigot to facilitate sampling. Soil depth for all columns will be 18” after compaction, which is a standard depth used in bay area bioretention installations (see Figure 9-1 below). To retain soil the bottom of the soil layer will be contained by a layer of filter fabric on top of structural backing. Behind each column, a yardstick will be mounted to the wall so that the depth of water in the column can be monitored.

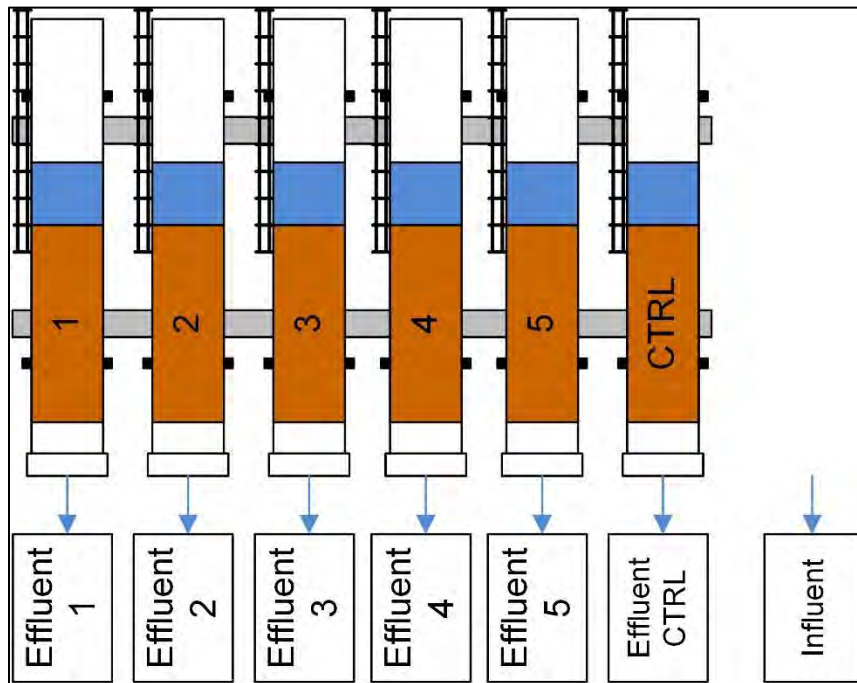

Figure 9-1. Column Test Setup

Dilution Run Column Setup: One of the existing biochar-amended BSM column and the standard BSM will be tested using diluted stormwater.

Testing procedure pre run setup: Before a sampling run begins a clean glass carboy will be placed under each soil column and labeled to match, this carboy will be sized to collect the full effluent volume

of the sample run. A glass beaker will also be assigned and labeled for each column of sufficient volume to accurately measure a single influent dose equivalent to 1 inch of depth in the column. An additional beaker will be prepared and labeled influent.

Media conditioning: Within 24 to 72 hours prior to the first column test run, pre-wet each column with a stormwater matrix collected from the CSUS campus by filling each column from the invert until water ponds above the media. Drain the water after 3 hours.

Sampling run: When the six glass carboys are delivered:

1. Inspect each carboy and fill out the Sample Receiving worksheet.
2. The runs will begin within 72 hours of delivery.
3. Select one carboy at random and fully mix it using a portable lab mixer for five minutes.
4. Turn off and remove the mixer, allow the sample to rest for one minute to allow the largest particles to settle to the bottom.
5. Fill each of the six dosing beakers and the one influent sample jar.
6. Pour each aliquot beaker into its respective column; record the time and height of water in each column.
7. Repeat steps 3-6 for each of the remaining carboys until a total of 18 inches of water is applied to each column. Before pouring an aliquot record the height of water in each column and the time. Pour each successive aliquot from the carboy when all columns have less than three inches of water above the soil surface. The water level should never be above 6 inches in any column at any time (6 inches is a standard ponding depth used in the bay area). Pour all aliquots from a single carboy into the columns at the same time.
8. Collect turbidity samples from the effluent of each column at the beginning, middle, and end of the sampling run. Fill the cuvettes for turbidity measurement directly from the effluent stream of each column and dispose of them after testing.
9. Collect mercury samples from the effluent of each column at the middle of the sample run using pre-labeled sample containers provided by the lab for that purpose.
10. Fill a pre-labeled sample jar from each columns effluent. The jar will be obtained from the laboratory performing the PCB analysis.
11. Pack each jar in ice and complete the lab COCs.
12. Ship the samples to the lab for analysis.

9.3.6. Sample ID Designations

Every sample must have a unique sample identification to ensure analytical results from each sample can be differentiated from every other sample. This information should follow the sample through the COC, analytical, and interpretation and reporting processes. Each influent and effluent water quality sample will be labeled according to the following naming convention:

SSS-TT-MMDDYYYY-##

Where:

SSS	Station code (see Table 9-2 for station codes)
TT	Sample Type (IN=influent; EF=Effluent)
MM	2 digit month of collection
DD	2 digit date of collection
YYYY	4 digit year of collection
##	Sequential 2-digit sample number (i.e., 01, 02, 03...etc.)

For example, a sample collected at the West Oakland Tree Well #2 site on October 20, 2017 and used for the influent sample for run #3 could be assigned the following sample ID: TW2-IN-09202017-03.

Table 9-2 Station Codes for Stormwater Influent Samples and Column Tests.

Station Code	Station Description
TW2	Stormwater sample collected from the West Oakland Tree Well #2
TW6	Stormwater sample collected from the West Oakland Tree Well #6
CO1	Effluent sample collected from column number 1
CO2	Effluent sample collected from column number 2
CO3	Effluent sample collected from column number 3
CO4	Effluent sample collected from column number 4
CO5	Effluent sample collected from column number 5
CO6	Effluent sample collected from column number 6

9.4. Collection of Samples for Archiving

Archive samples will not be collected for this Monitoring Program. The sample size collected will be enough to support additional analyses if QA/QC issues arise. Once quality assurance is certified by the QA Officer, the laboratory will be instructed to dispose of any leftover sample materials.

9.5. Waste Disposal

Proper disposal of all waste is an important component of field activities. At no time will any waste be disposed of improperly. The proper methods of waste disposal are outlined below:

9.5.1. Routine Garbage

Regular garbage (paper towels, paper cups, etc.) is collected by sampling personnel in garbage bags or similar. It can then be disposed of properly at appropriate intervals.

9.5.2. Detergent Washes

Any detergents used or detergent wash water should be collected in the field in a water-tight container and disposed of appropriately.

9.5.3. Chemicals

Methanol, if used, should be disposed of by following all appropriate regulations. It should always be collected when sampling and never be disposed in the field.

9.1. Responsibility and Corrective Actions

If monitoring equipment fails, sampling personnel will report the problem in the comments section of their field notes and will not record data values for the variables in question. Actions will be taken to replace or repair broken equipment prior to the next field use.

9.2. Standard Operating Procedures

SOPs associated with sampling and sample handling expected to be used as part of implementation of The Monitoring Program are identified in Table 9-3. Additional details on sample container information, required preservation, holding times, and sample volumes for all Monitoring Program analytes are listed

in Table 10-1 of Section 10.

Table 9-3. List of BASMAA RMC SOPs Utilized by the Monitoring Program.

RMC SOP #	RMC SOP	Source
FS-2	Water Quality Sampling for Chemical Analysis, Pathogen Indicators, and Toxicity	BASMAA 2016
FS-3	Field Measurements, Manual	BASMAA 2016
FS-4	Field Measurements, Continuous General Water Quality	BASMAA 2016
FS-5	Temperature, Automated, Digital Logger	BASMAA 2016
FS-6	Collection of Bedded Sediment Samples for Chemical Analysis and Toxicity	BASMAA 2016
FS-7	Field Equipment Cleaning Procedures	BASMAA 2016
FS-8	Field Equipment Decontamination Procedures	BASMAA 2016
FS-9	Sample Container, Handling, and Chain of Custody Procedures	BASMAA 2016
FS-10	Completion and Processing of Field Datasheets	BASMAA 2016
FS-11	Site and Sample Naming Convention	BASMAA 2016

In addition, contractor-specific plans and procedures may be required for specific aspects of the Monitoring Program implementation (e.g., health and safety plans, dry ice shipping procedures).

10. Sample Handling and Custody

Sample handling and chain of custody procedures are described in detail in RMC SOP FS-9 (Table 9-3) (BASMAA 2016). The Field-PM or designated municipal staff on site during sample collection will be responsible for overall collection and custody of samples during field sampling. Field crews will keep a field log, which will consist of sampling forms for each sampling event. Sample collection methods described in this document and the study designs (BASMAA 2017a, b) will be followed for each sampling task. Field data sheets will be filled out for each sample collected during the project. Example field data sheets are provided in Appendix A, and described further in Section 9.

The field crews will have custody of samples during field sampling, and COC forms will accompany all samples from field collection until delivery to the analyzing laboratory. COC procedures require that possession of samples be traceable from the time the samples are collected until completion and submittal of analytical results. Each laboratory will follow sample custody procedures as outlined in its QA plans.

Information on sampling containers, preservation techniques, packaging and shipping, and hold times is described below and summarized in Table 10.1.

10.1. Sampling Containers

Collection of all sample types require the use of clean containers. Factory pre-cleaned sample containers of the appropriate type will be provided by the contracted laboratory and delivered to field team at least one week prior to the start of sample collection. Individual laboratories will be responsible for the integrity of containers provided. The number and type of sample containers required for all analytes by media type for each sampling task are provided in Table 10.1.

10.2. Sample Preservation

Field Crews will collect samples in the field in a way that neither contaminates, loses, or changes the chemical form of the analytes of interest. The samples will be collected in the field into pre-cleaned sample containers of a material appropriate to the analysis to be conducted. Pre-cleaned sampling equipment is used for each site, whenever possible and/or when necessary. Appropriate sampling technique and measurement equipment may vary depending on the location, sample type, sampling objective, and weather.

In general, all samples will be packed in sufficient wet ice or frozen ice packs during shipment, so that they will be kept between 2 and 4° C (Table 10.1). When used, wet ice will be double bagged in Zip-top bags to prevent contamination via melt water. Where appropriate, samples may be frozen to prevent degradation. If samples are to be shipped frozen on dry ice, then appropriate handling procedures will be followed, including ensuring use of appropriate packaging materials and appropriate training for shipping personnel.

10.3. Packaging and Shipping

All samples will be handled, prepared, transported, and stored in a manner so as to minimize bulk loss, analyte loss, contamination, or biological degradation. Sample containers will be clearly labeled with an indelible marker. All caps and lids will be checked for tightness prior to shipping. Ice chests will be sealed with packing tape before shipping. Samples will be placed in the ice chest with enough ice or frozen ice packs to maintain between 2 and 4° C. Additional packing material will be added as needed. COC forms will be placed in a zip-top bag and placed inside of the ice chest.

10.4. Commercial Vehicle Transport

If transport of samples to the contracted laboratories is to be by commercial carriers, pickup will be pre-arranged with the carrier and all required shipping forms will be completed prior to sample pickup by the commercial carrier.

10.5. Sample Hold Times

Sample hold times for each analyte by media type are presented in Table 10-1.

Table 10-1 Sample Handling for the Monitoring Program Analytes by media type.

Analyte	Sample Media	Sample Container	Minimum Sample / Container Size ^a	Preservative	Hold Time (at 6° C)
PCBs (40-RMP Congeners)	Caulk or sealant	Pre-cleaned 250-mL glass sample container (e.g., Quality Certified™, ESS Vial, Oakland, CA)	10 g	Cool to 6° C within 24 hours, then freeze to ≤-20° C	1 year at -20° C; Samples must be analyzed within 14 days of collection or thawing.
	Sediment	Pre-cleaned 250-mL I-Chem 200 Series amber glass jar with Teflon lid liner	500 mL (two jars)	Cool to 6° C within 24 hours, then freeze to ≤-20° C	1 year at -20° C; Samples must be analyzed within 14 days of collection or thawing.
	Water	1000-mL I-Chem 200-Series amber glass bottle, with Teflon lid-liner	1000 mL/per individual analyses	Cool to 6° C in the dark.	1 year until extraction, 1 year after extraction
Total Mercury	Sediment	Pre-cleaned 250-mL I-Chem 200 Series amber glass jar with Teflon lid liner	100 g	Cool to 6° C and in the dark	1 year at -20° C; Samples must be analyzed within 14 days of collection or thawing.
	Water	250-mL glass or acid-cleaned Teflon bottle	250 mL	Cool to 6° C in the dark and acidify to 0.5% with pre-tested HCl within 48 hours	6 months at room temperature following acidification
Bulk Density	Sediment	250-mL clear glass jar; pre-cleaned	250 mL	Cool to 6° C	7 days
Grain Size and TOC	Sediment	250-mL clear glass jar; pre-cleaned	250 mL	Cool to 6° C, in the dark up to 28 days ²	28 days at ≤6 °C; 1 year at ≤-20 °C
SSC	Water	125-mL amber glass jar or Polyethylene Bottles	125 mL	Cool to 6° C and store in the dark	7 days
Turbidity	Water				
Total Solids	Water	1 L HDPE	1 L	Cool to ≤6 °C	7 days
TOC	Water	40-mL glass vial	40 mL	Cool to 6° C and store in the dark. If analysis is to occur more than two hours after sampling, acidify (pH < 2) with HCl or H ₂ SO ₄ .	28 days
Particle Size Distribution	Water	1 L HDPE	2 L	Cool to 6° C and store in the dark	7 days

^aQC samples or other analytes require additional sample bottles.

11. Field Health and Safety Procedures

All field crews will be expected to abide by their employer's (i.e., the field contractor's) health and safety programs. Additionally, prior to the fieldwork, field contractors are required to develop site-specific Health and Safety plans that include the locations of the nearest emergency medical services.

Implementation of the Monitoring Program activities may require confined space entry (CSE) to accomplish sampling goals. Sampling personnel conducting any confined space entry activities will be expected to be certified for CSE and to abide by relevant regulations.

12. Laboratory Analytical Methods

12.1. Caulk/Sealant Samples (Task 1)

12.1.1. XRF Chlorine analysis

XRF technology will be used in a laboratory setting to rank samples for chlorine content before sending the samples to the project laboratory for chemical analysis. Procedures for testing caulk or sealants using X-Ray fluorescence (XRF) and collecting caulk and sealant samples are not well described, and minimal detail on caulk or sealant sample collection is available in peer-reviewed publications. Sealant sampling procedures were adapted from the previous study examining PCBs in building materials (Klosterhaus et al., 2014).

An XRF analyzer will be used at the Center for Environmental Health (CEH) as a screening tool to estimate the concentration of chlorine (Cl) in collected caulk and sealant samples from various structures. Settings for the analyzer will be 'standardized' using procedures developed/ recommended by CEH each time the instrument is turned on and prior to any measurement. European plastic pellet reference materials (EC680 and EC681) will be used as 'check' standards upon first use to verify analyzer performance. A 30 second measurement in 'soil' mode will be used. CEH personnel will inspect the caulk/sealant surfaces and use a stainless steel blade to scrape off any paint, concrete chips, or other visible surface residue. The caulk/sealant surface to be sampled will then be wiped with a laboratory tissue to remove any remaining debris that may potentially interfere with the XRF analysis. At least two XRF readings will be collected from each sample switching the orientation or position of the sample between readings. If Cl is detected, a minimum of four additional readings will be collected on the same material to determine analytical variability. Each individual Cl reading and its detection limit will be recorded on the data sheet. After XRF analysis, all samples will be returned to their original sample container. Results of the XRF analysis will be provided to the project team as a table of ranked Cl screening results for possible selection for chemical (PCBs) analysis.

12.1.2. Selection of Samples for PCB analysis and Compositing

Once samples have been ranked for their chlorine content, primarily samples with the highest Cl will preferentially be selected for chemical analysis. About 75% of samples to be analyzed should be selected from samples with the top quartile Cl content. The remaining 25% should be selected from samples with medium (25 to 75th percentile) Cl, as the previous study using XRF screening showed inconsistent correlation between total Cl and PCB. Although samples with very low Cl seldom had much PCBs, samples with medium Cl on occasion had higher PCBs than samples with high Cl, and within the high Cl group, Cl content was not a good predictor of their ranks of PCB concentration.

In addition to Cl content, other factors about each sample that were recorded on the field data sheets at the time of sample collection, including the color or consistency of the sample, the type and/or age of the structure that was sampled, or the type of caulk or sealant application will be considered in selecting the samples that will be sent to the laboratory for PCBs analysis, as well as how the samples will be grouped for compositing purposes. Those factors are described in more detail in the study design (BASMAA, 2017a).

The Consultant PM will work with the project team to identify up to three samples for inclusion in each composite. A common composite ID will then be assigned to each sample that will be composited together (i.e., all samples the lab should composite together will be identified by the common composite ID). The composite ID will consist of a single letter designation and will be identical for all samples (up to 3 total) that will be composited together. The Consultant PM will add the composite ID to each sample container label, to each sample ID on all COC forms, and to each field data sheet for all samples prior to sending the samples to the laboratory for PCBs analysis.

12.1.3. Sample Preparation

The project laboratory will composite the samples prior to extraction and PCBs analysis according to the groupings identified by the common composite ID. Sample preparation will include removal of any paint, concrete chips, or other surface debris, followed by homogenization of the caulk/sealant material and compositing up to three samples per composite. Each sample will have a composite ID that will be used to identify which samples should be composited together. Samples with the same composite ID will be combined into a single composite sample. For example, all samples with composite ID = “A” will be composited together; all samples with composite ID = “B” will be composited together, etc. Sample preparation and compositing will follow the procedures outlined in the laboratory SOPs (Appendix B). After compositing, each composite sample will be assigned a new sample ID using the following naming convention:

X-MMDDYYYY

Where:

- X the single letter Composite ID that is common to all samples included in a given composite.
- MM 2 digit month of composite preparation
- DD 2 digit date of composite preparation
- YYYY 4 digit year of composite preparation

For example, if three samples with the composite ID= “A” are combined into a single composite sample on December 12, 2017, the new (composite) sample ID would be the following: A-12122017.

12.1.4. PCBs Analysis

All composite caulk/sealant samples will be extracted by Method 3540C, and analyzed for the RMP-40 PCB congeners³ using a modified EPA Method 8270C (GC/MS-SIM), in order to obtain positive

³ The 40 individual congeners routinely quantified by the Regional Monitoring Program (RMP) for Water Quality in the San Francisco Estuary include: PCBs 8, 18, 28, 31, 33, 44, 49, 52, 56, 60, 66, 70, 74, 87, 95, 97, 99, 101, 105, 110, 118, 128, 132, 138, 141, 149, 151, 153, 156, 158, 170, 174, 177, 180, 183, 187, 194, 195, 201, and 203

identification and quantitation of PCBs. PCB content of these material covers an extremely wide range, so the subsampling of material should include sufficient material for quantification assuming that the concentration is likely to be around the median of previous results. There may be samples with much higher concentrations, which can be reanalyzed on dilution as needed. Method Reporting Limits (MRLs) for each of the RMP-40 PCB Congeners are 0.5 µg/Kg.

12.2. Sediment Samples Collected from HDS Units (Task 2)

All sediment samples collected from HDS units under Task 2 will be analyzed for TOC, grain size, bulk density, total mercury, and PCBs (RMP 40 Congeners) by the methods identified in Table 12-1. All sediment samples (with the exception of grain size) will be sieved by the laboratory at 2 mm prior to analysis.

Table 12-1. Laboratory Analytical Methods for Analytes in Sediment

Analyte	Sampling Method	Recommended Analytical Method	Reporting Units
Total Organic Carbon (TOC)	Grab	EPA 415.1, 440.0, 9060, or ASTM D4129M	%
Grain Size	Grab	ASTM D422M/PSEP	%
Bulk Density	Grab	ASTM E1109-86	g/cm ³
Mercury	Grab	EPA 7471A, 7473, or 1631	µg/kg
PCBs (RMP 40 Congeners)	Grab	EPA 1668	µg/kg

12.3. Water Samples – Stormwater and Column Tests (Task 3)

All water samples submitted to the laboratory will be analyzed for SSC, TOC, total mercury and PCBs (RMP-40 congeners) according to the methods identified in Table 12-2.

Table 12-2. Laboratory Analytical Methods for Analytes in Water

Analyte	Sampling Method	Recommended Analytical Method	Reporting Units
Suspended Sediment Concentration (SSC)	Grab	ASTM D3977-97 (Method C)	mg/L
Total Organic Carbon (TOC)	Grab	EPA 415.1 or SM 5310B	%
Mercury (Total)	Grab	EPA 1631	µg/L
PCBs (RMP 40 Congeners)	Grab	EPA 1668	ng/L

12.4. Method Failures

The QA Officer will be responsible for overseeing the laboratory implementing any corrective actions that may be needed in the event that methods fail to produce acceptable data. If a method fails to provide acceptable data for any reason, including analyte or matrix interferences, instrument failures, etc., then the involved samples will be analyzed again if possible. The laboratory in question's SOP for handling these types of problems will be followed. When a method fails to provide acceptable data, then the laboratory's

SOP for documenting method failures will be used to document the problem and what was done to rectify it.

Corrective actions for chemical data are taken when an analysis is deemed suspect for some reason. These reasons include exceeding accuracy or precision ranges and/or problems with sorting and identification. The corrective action will vary on a case-by-case basis, but at a minimum involves the following:

- A check of procedures.
- A review of documents and calculations to identify possible errors.
- Correction of errors based on discussions among analysts.
- A complete re-identification of the sample.

The field and laboratory coordinators shall have systems in place to document problems and make corrective actions. All corrective actions will be documented to the FTL and the QA Officer.

12.5. Sample Disposal

After analysis of the Monitoring Program samples has been completed by the laboratory and results have been accepted by QA Officer and the Field-PM, they will be disposed by laboratory staff in compliance with all federal, state, and local regulations. The laboratory has standard procedures for disposing of its waste, including left over sample materials

12.6. Laboratory Sample Processing

Field samples sent to the laboratories will be processed within their recommended hold time using methods agreed upon method between the Lab-PM and Field-PM. Each sample may be assigned unique laboratory sample ID numbers for tracking processing and analyses of samples within the laboratory. This laboratory sample ID (if differing from the field team sample ID) must be included in the data submission, within a lookup table linking the field sample ID to that assigned by the lab.

Samples arriving at the laboratory are to be stored under conditions appropriate for the planned analytical procedure(s), unless they are processed for analysis immediately upon receipt. Samples to be analyzed should only be removed from storage when laboratory staff are ready to proceed.

13. Quality Control

Each step in the field collection and analytical process is a potential source of contamination and must be consistently monitored to ensure that the final measurement is not adversely affected by any processing steps. Various aspects of the quality control procedures required by the Monitoring Program are summarized below.

13.1. Field Quality Control

Field QC results must meet the MQOs and frequency requirements specified in Tables 13-1 – 13-4 below.

13.1.1. Field Blanks

A field blank is collected to assess potential sample contamination levels that occur during field sampling activities. Field blanks are taken to the field, transferred to the appropriate container, preserved (if required by the method), and treated the same as the corresponding sample type during the course of a sampling event. The inclusion of field blanks is dependent on the requirements specified in the relevant MQO tables or in the sampling method or SOP.

Collection of caulk or sealant field blank samples has been deemed unnecessary due to the difficulty in collection and interpretation of representative blank samples and the use of precautions that minimize contamination of the samples. Additionally, PCBs have been reported to be present in percent concentrations when used in sealants; therefore any low level contamination (at ppb or even ppm level) due to sampling equipment and procedures is not expected to affect data quality because it would be many orders of magnitude lower than the concentrations deemed to be a positive PCB signal.

For stormwater samples, field blanks will be generated using lab supplied containers and clean matrices. Sampling containers will be opened as though actual samples were to be collected, and clean lab-supplied matrix (if any) will be transferred to sample containers for analysis.

13.1.2. Field Duplicates

Field samples collected in duplicate provide precision information as it pertains to the sampling process. The duplicate sample must be collected in the same manner and as close in time as possible to the original sample. This effort is to attempt to examine field homogeneity as well as sample handling, within the limits and constraints of the situation. These data are evaluated in the data analysis/assessment process for small-scale spatial variability.

Field duplicates will not be collected for caulk/sealant samples (Task 1), as assessment of within-structure variability of PCB concentrations in sealants is not a primary objective of the Project. Due to budget limitations, PCBs analysis of only one caulk/sealant sample per application will be targeted to maximize the number of Bay Area structures and structure types that may be analyzed in the Project. The selected laboratory will conduct a number of quality assurance analyses (see Section 13), including a limited number of sample duplicates, to evaluate laboratory and method performance as well as variability of PCB content within a sample.

For all sediment and water samples, 5% of field duplicates and/or column influent/effluent duplicates will be collected along with primary samples in order to evaluate small scale spatial or temporal variability in sample collection without specifically targeting any apparent or likely bias (e.g. different sides of a seemingly symmetrical unit, or offset locations in making a composite, or immediately following collection of a primary water sample would be acceptable, whereas collecting one composite near an inlet and another near the outlet, or intentionally collecting times with vastly different flow rates, would not be desirable).

13.1.3. Field Corrective Action

The Field PM is responsible for responding to failures in their sampling and field measurement systems. If monitoring equipment fails, personnel are to record the problem according to their documentation protocols. Failing equipment must be replaced or repaired prior to subsequent sampling events. It is the combined responsibility of all members of the field organization to determine if the performance

requirements of the specific sampling method have been met, and to collect additional samples if necessary. Associated data is to be flagged accordingly. Specific field corrective actions are detailed in Table 13-8.

13.2. Laboratory Quality Control

Laboratories providing analytical support to the Monitoring Program will have the appropriate facilities to store, prepare, and process samples in an ultra-clean environment, and will have appropriate instrumentation and staff to perform analyses and provide data of the required quality within the time period dictated by the Monitoring Program. The laboratories are expected to satisfy the following:

1. Demonstrate capability through pertinent certification and satisfactory performance in inter-laboratory comparison exercises.
2. Provide qualification statements regarding their facility and personnel.
3. Maintain a program of scheduled maintenance of analytical balances, laboratory equipment and instrumentation.
4. Conduct routine checking of analytical balances using a set of standard reference weights (American Society of Testing and Materials Class 3, NIST Class S-1, or equivalents). Analytical balances are serviced at six-month intervals or when test weight values are not within the manufacturer's instrument specifications, whichever occurs first.
5. Conduct routine checking and recording the composition of fresh calibration standards against the previous lot. Acceptable comparisons are within 2% of the precious value.
6. Record all analytical data in bound (where possible) logbooks, with all entries in ink, or electronically.
7. Monitor and document the temperatures of cold storage areas and freezer units on a continuous basis.
8. Verify the efficiency of fume/exhaust hoods.
9. Have a source of reagent water meeting specifications described in Section 8.0 available in sufficient quantity to support analytical operations.
10. Label all containers used in the laboratory with date prepared, contents, initials of the individual who prepared the contents, and other information as appropriate.
11. Date and safely store all chemicals upon receipt. Proper disposal of chemicals when the expiration date has passed.
12. Have QAPP, SOPs, analytical methods manuals, and safety plans readily available to staff.
13. Have raw analytical data readily accessible so that they are available upon request.

In addition, laboratories involved in the Monitoring Program are required to demonstrate capability continuously through the following protocols:

1. Strict adherence to routine QA/QC procedures.
2. Regular participation in annual certification programs.
3. Satisfactory performance at least annually in the analysis of blind Performance Evaluation Samples and/or participation in inter-laboratory comparison exercises.

Laboratory QC samples must satisfy MQOs and frequency requirements. MQOs and frequency requirements are listed in Tables 13-1 – 13-3. Frequency requirements are provided on an analytical batch

level. The Monitoring Program defines an analytical batch as 20 or fewer samples and associated quality control that are processed by the same instrument within a 24-hour period (unless otherwise specified by method). Target Method Reporting Limits are provided in Tables 13.4 – 13.8. Details regarding sample preparation are method- or laboratory SOP-specific, and may consist of extraction, digestion, or other techniques.

13.2.1. Calibration and Working Standards

All calibration standards must be traceable to a certified standard obtained from a recognized organization. If traceable standards are not available, procedures must be implemented to standardize the utilized calibration solutions (*e.g.*, comparison to a CRM – see below). Standardization of calibration solutions must be thoroughly documented, and is only acceptable when pre-certified standard solutions are not available. Working standards are dilutions of stock standards prepared for daily use in the laboratory. Working standards are used to calibrate instruments or prepare matrix spikes, and may be prepared at several different dilutions from a common stock standard. Working standards are diluted with solutions that ensure the stability of the target analyte. Preparation of the working standard must be thoroughly documented such that each working standard is traceable back to its original stock standard. Finally, the concentration of all working standards must be verified by analysis prior to use in the laboratory.

13.2.2. Instrument Calibration

Prior to sample analysis, utilized instruments must be calibrated following the procedures outlined in the relevant analytical method or laboratory SOP. Each method or SOP must specify acceptance criteria that demonstrate instrument stability and an acceptable calibration. If instrument calibration does not meet the specified acceptance criteria, the analytical process is not in control and must be halted. The instrument must be successfully recalibrated before samples may be analyzed.

Calibration curves will be established for each analyte covering the range of expected sample concentrations. Only data that result from quantification within the demonstrated working calibration range may be reported unflagged by the laboratory. Quantification based upon extrapolation is not acceptable; sample extracts above the calibration range should be diluted and rerun if possible. Data reported below the calibration range must be flagged as estimated values that are Detected not Quantified.

13.2.3. Initial Calibration Verification

The initial calibration verification (ICV) is a mid-level standard analyzed immediately following the calibration curve. The source of the standards used to calibrate the instrument and the source of the standard used to perform the ICV must be independent of one another. This is usually achieved by the purchase of standards from separate vendors. Since the standards are obtained from independent sources and both are traceable, analyses of the ICV functions as a check on the accuracy of the standards used to calibrate the instrument. The ICV is not a requirement of all SOPs or methods, particularly if other checks on analytical accuracy are present in the sample batch.

13.2.4. Continuing Calibration Verification

Continuing calibration verification (CCV) standards are mid-level standards analyzed at specified intervals during the course of the analytical run. CCVs are used to monitor sensitivity changes in the instrument during analysis. In order to properly assess these sensitivity changes, the standards used to perform CCVs must be from the same set of working standards used to calibrate the instrument. Use of a

second source standard is not necessary for CCV standards, since other QC samples are designed to assess the accuracy of the calibration standards. Analysis of CCVs using the calibration standards limits this QC sample to assessing only instrument sensitivity changes. The acceptance criteria and required frequency for CCVs are detailed in Tables 13-1 through 13-3. If a CCV falls outside the acceptance limits, the analytical system is not in control, and immediate corrective action must be taken.

Data obtained while the instrument is out of control is not reportable, and all samples analyzed during this period must be reanalyzed. If reanalysis is not an option, the original data must be flagged with the appropriate qualifier and reported. A narrative must be submitted listing the results that were generated while the instrument was out of control, in addition to corrective actions that were applied.

13.2.5. Laboratory Blanks

Laboratory blanks (also called extraction blanks, procedural blanks, or method blanks) are used to assess the background level of a target analyte resulting from sample preparation and analysis. Laboratory blanks are carried through precisely the same procedures as the field samples. For both organic and inorganic analyses, a minimum of at least one laboratory blank must be prepared and analyzed in every analytical batch or per 20 samples, whichever is more frequent. Some methods may require more than one laboratory blank with each analytical run. Acceptance criteria for laboratory blanks are detailed in Tables 13-1 through 13-3. Blanks that are too high require corrective action to bring the concentrations down to acceptable levels. This may involve changing reagents, cleaning equipment, or even modifying the utilized methods or SOPs. Although acceptable laboratory blanks are important for obtaining results for low-level samples, improvements in analytical sensitivity have pushed detection limits down to the point where some amount of analyte will be detected in even the cleanest laboratory blanks. The magnitude of the blanks must be evaluated against the concentrations of the samples being analyzed and against project objectives.

13.2.6. Reference Materials and Demonstration of Laboratory Accuracy

Evaluation of the accuracy of laboratory procedures is achieved through the preparation and analysis of reference materials with each analytical batch. Ideally, the reference materials selected are similar in matrix and concentration range to the samples being prepared and analyzed. The acceptance criteria for reference materials are listed in Tables 13-1 – 13-3. The accuracy of an analytical method can be assessed using CRMs only when certified values are provided for the target analytes. When possible, reference materials that have certified values for the target analytes should be used. This is not always possible, and often times certified reference values are not available for all target analytes. Many reference materials have both certified and non-certified (or reference) values listed on the certificate of analysis. Certified reference values are clearly distinguished from the non-certified reference values on the certificate of analysis.

13.2.7. Reference Materials vs. Certified Reference Materials

The distinction between a reference material and a certified reference material does not involve how the two are prepared, rather with the way that the reference values were established. Certified values are determined through replicate analyses using two independent measurement techniques for verification. The certifying agency may also provide “non-certified or “reference” values for other target analytes. Such values are determined using a single measurement technique that may introduce bias. When available, it is preferable to use reference materials that have certified values for all target analytes. This is not always an option, and therefore it is acceptable to use materials that have reference values for these

analytes. Note: Standard Reference Materials (SRMs) are essentially the same as CRMs. The term “Standard Reference Material” has been trademarked by the National Institute of Standards and Technology (NIST), and is therefore used only for reference materials distributed by NIST.

13.2.8. Laboratory Control Samples

While reference materials are not available for all analytes, a way of assessing the accuracy of an analytical method is still required. LCSs provide an alternate method of assessing accuracy. An LCS is a specimen of known composition prepared using contaminant-free reagent water or an inert solid spiked with the target analyte at the midpoint of the calibration curve or at the level of concern. The LCS must be analyzed using the same preparation, reagents, and analytical methods employed for regular samples. If an LCS needs to be substituted for a reference material, the acceptance criteria are the same as those for the analysis of reference materials..

13.2.9. Prioritizing Certified Reference Materials, Reference Materials, and Laboratory Control Samples

Certified reference materials, reference materials, and laboratory control samples all provide a method to assess the accuracy at the mid-range of the analytical process. However, this does not mean that they can be used interchangeably in all situations. When available, analysis of one certified reference material per analytical batch should be conducted. Certified values are not always available for all target analytes. If no certified reference material exists, reference values may be used. If no reference material exists for the target analyte, an LCS must be prepared and analyzed with the sample batch as a means of assessing accuracy. The hierarchy is as follows: analysis of a CRM is favored over the analysis of a reference material, and analysis of a reference material is preferable to the analysis of an LCS. Substitution of an LCS is not acceptable if a certified reference material or reference material is available, contact the Project Manager and QAO for approval before relying exclusively on an LCS as a measure of accuracy.

13.2.10. Matrix Spikes

A MS is prepared by adding a known concentration of the target analyte to a field sample, which is then subjected to the entire analytical procedure. The MS is analyzed in order to assess the magnitude of matrix interference and bias present. Because these spikes are often analyzed in pairs, the second spike is called the MSD. The MSD provides information regarding the precision of measurement and consistency of the matrix effects. Both the MS and MSD are split from the same original field sample. In order to properly assess the degree of matrix interference and potential bias, the spiking level should be approximately 2-5x the ambient concentration of the spiked sample. To establish spiking levels prior to sample analysis, if possible, laboratories should review any relevant historical data. In many instances, the laboratory will be spiking samples blind and will not meet a spiking level of 2-5x the ambient concentration. In addition to the recoveries, the relative percent difference (RPD) between the MS and MSD is calculated to evaluate how matrix affects precision. The MQO for the RPD between the MS and MSD is the same regardless of the method of calculation. These are detailed in Tables 13-1 – 13-3. Recovery data for matrix spikes provides a basis for determining the prevalence of matrix effects in the samples collected and analyzed. If the percent recovery for any analyte in the MS or MSD is outside of the limits specified in Tables 13-1 – 13-3, the chromatograms (in the case of trace organic analyses) and raw data quantitation reports should be reviewed. Data should be scrutinized for evidence of sensitivity shifts (indicated by the results of the CCVs) or other potential problems with the analytical process. If associated QC samples (reference materials or LCSs) are in control, matrix effects may be the source of

the problem. If the standard used to spike the samples is different from the standard used to calibrate the instrument, it must be checked for accuracy prior to attributing poor recoveries to matrix effects.

13.2.11.Laboratory Duplicates

In order to evaluate the precision of an analytical process, a field sample is selected and prepared in duplicate. Specific requirements pertaining to the analysis of laboratory duplicates vary depending on the type of analysis. The acceptance criteria for laboratory duplicates are specified in Tables 13-1 – 13-3.

13.2.12.Laboratory Duplicates vs. Matrix Spike Duplicates

Although the laboratory duplicate and matrix spike duplicate both provide information regarding precision, they are unique measurements. Laboratory duplicates provide information regarding the precision of laboratory procedures at actual ambient concentrations. The matrix spike duplicate provides information regarding how the matrix of the sample affects both the precision and bias associated with the results. It also determines whether or not the matrix affects the results in a reproducible manner. MS/MSDs are often spiked at levels well above ambient concentrations, so thus are not representative of typical sample precision. Because the two concepts cannot be used interchangeably, it is unacceptable to analyze only an MS/MSD when a laboratory duplicate is required.

13.2.13.Replicate Analyses

The Monitoring Program will adopt the same terminology as SWAMP in defining replicate samples, wherein replicate analyses are distinguished from duplicate analyses based simply on the number of involved analyses. Duplicate analyses refer to two sample preparations, while replicate analyses refer to three or more. Analysis of replicate samples is not explicitly required.

13.2.14.Surrogates

Surrogate compounds accompany organic measurements in order to estimate target analyte losses or matrix effects during sample extraction and analysis. The selected surrogate compounds behave similarly to the target analytes, and therefore any loss of the surrogate compound during preparation and analysis is presumed to coincide with a similar loss of the target analyte. Surrogate compounds must be added to field and QC samples prior to extraction, or according to the utilized method or SOP. Surrogate recovery data are to be carefully monitored. If possible, isotopically labeled analogs of the analytes are to be used as surrogates.

13.2.15.Internal Standards

To optimize gas chromatography mass spectrometry (GC-MS) analysis, internal standards (also referred to as “injection internal standards”) may be added to field and QC sample extracts prior to injection. Use of internal standards is particularly important for analysis of complex extracts subject to retention time shifts relative to the analysis of standards. The internal standards can also be used to detect and correct for problems in the GC injection port or other parts of the instrument. The analyst must monitor internal standard retention times and recoveries to determine if instrument maintenance or repair or changes in analytical procedures are indicated. Corrective action is initiated based on the judgment of the analyst. Instrument problems that affect the data or result in reanalysis must be documented properly in logbooks and internal data reports, and used by the laboratory personnel to take appropriate corrective action. Performance criteria for internal standards are established by the method or laboratory SOP.

13.2.16. Dual-Column Confirmation

Due to the high probability of false positives from single-column analyses, dual column confirmation should be applied to all gas chromatography and liquid chromatography methods that do not provide definitive identifications. It should not be restricted to instruments with electron capture detection (ECD).

13.2.17. Dilution of Samples

Final reported results must be corrected for dilution carried out during the process of analysis. In order to evaluate the QC analyses associated with an analytical batch, corresponding batch QC samples must be analyzed at the same dilution factor. For example, the results used to calculate the results of matrix spikes must be derived from results for the native sample, matrix spike, and matrix spike duplicate analyzed at the same dilution. Results derived from samples analyzed at different dilution factors must not be used to calculate QC results.

13.2.18. Laboratory Corrective Action

Failures in laboratory measurement systems include, but are not limited to: instrument malfunction, calibration failure, sample container breakage, contamination, and QC sample failure. If the failure can be corrected, the analyst must document it and its associated corrective actions in the laboratory record and complete the analysis. If the failure is not resolved, it is conveyed to the respective supervisor who should determine if the analytical failure compromised associated results. The nature and disposition of the problem must be documented in the data report that is sent to the Consultant-PM. Suggested corrective actions are detailed in Table 13-9.

Table 13-1. Measurement Quality Objectives - PCBs.

Laboratory Quality Control	Frequency of Analysis	Measurement Quality Objective
Tuning²	Per analytical method	Per analytical method
Calibration	Initial method setup or when the calibration verification fails	<ul style="list-style-type: none"> Correlation coefficient ($r^2 > 0.990$) for linear and non-linear curves If $RSD < 15\%$, average RF may be used to quantitate; otherwise use equation of the curve First- or second-order curves only (not forced through the origin) Refer to SW-846 methods for SPCC and CCC criteria² Minimum of 5 points per curve (one of them at or below the RL)
Calibration Verification	Per 12 hours	<ul style="list-style-type: none"> Expected response or expected concentration $\pm 20\%$ RF for SPCCs=initial calibration⁴
Laboratory Blank	Per 20 samples or per analytical batch, whichever is more frequent	<RL for target analytes
Reference Material	Per 20 samples or per analytical batch	70-130% recovery if certified; otherwise, 50-150% recovery
Matrix Spike	Per 20 samples or per analytical batch, whichever is more frequent	50-150% or based on historical laboratory control limits (average $\pm 3SD$)
Matrix Spike Duplicate	Per 20 samples or per analytical batch, whichever is more frequent	50-150% or based on historical laboratory control limits (average $\pm 3SD$); $RPD < 25\%$
Surrogate	Included in all samples and all QC samples	Based on historical laboratory control limits (50-150% or better)
Internal Standard	Included in all samples and all QC samples (as available)	Per laboratory procedure
Field Quality Control	Frequency of Analysis	Measurement Quality Objective
Field Duplicate	5% of total Project sample count (sediment and water samples only)	$RPD < 25\%$ (n/a if concentration of either sample < RL)
Field Blank	Not required for the Monitoring Program	<RL for target analytes

Table 13-2. Measurement Quality Objectives – Inorganic Analytes.

Laboratory Quality Control	Frequency of Analysis	Measurement Quality Objective
Calibration Standard	Per analytical method or manufacturer's specifications	Per analytical method or manufacturer's specifications
Continuing Calibration Verification	Per 10 analytical runs	80-120% recovery
Laboratory Blank	Per 20 samples or per analytical batch, whichever is more frequent	<RL for target analyte
Reference Material	Per 20 samples or per analytical batch, whichever is more frequent	75-125% recovery
Matrix Spike	Per 20 samples or per analytical batch, whichever is more frequent	75-125% recovery
Matrix Spike Duplicate	Per 20 samples or per analytical batch, whichever is more frequent	75-125% recovery ; RPD<25%
Laboratory Duplicate	Per 20 samples or per analytical batch, whichever is more frequent	RPD<25% (n/a if concentration of either sample<RL)
Internal Standard	Accompanying every analytical run when method appropriate	60-125% recovery
Field Quality Control	Frequency of Analysis	Measurement Quality Objective
Field Duplicate	5% of total Project sample count	RPD<25% (n/a if concentration of either sample<RL), unless otherwise specified by method
Field Blank, Equipment Field, Eqpt Blanks	Not required for the Monitoring Program	Blanks<RL for target analyte

Table 13-3. Measurement Quality Objectives – Conventional Analytes.

Laboratory Quality Control	Frequency of Analysis	Measurement Quality Objective
Calibration Standard	Per analytical method or manufacturer's specifications	Per analytical method or manufacturer's specifications
Laboratory Blank	Total organic carbon only: one per 20 samples or per analytical batch, whichever is more frequent (n/a for other parameters)	80-120% recovery
Reference Material	One per analytical batch	RPD<25% (n/a if native concentration of either sample<RL)
Laboratory Duplicate	(TOC only) one per 20 samples or per analytical batch, whichever is more frequent (n/a for other parameters)	80-120% recovery
Field Quality Control	Frequency of Analysis	Measurement Quality Objective
Field Duplicate	5% of total Project sample count	RPD<25% (n/a if concentration of either sample<RL)
Field Blank, Travel Blank, Field Blanks	Not required for the Monitoring Program analytes	NA

Consistent with SWAMP QAPP and as applicable, percent moisture should be reported with each batch of sediment samples. Sediment data must be reported on a dry weight basis.

Table 13-4. Target MRLs for Sediment Quality Parameters.

Analyte	MRL
Sediment Total Organic Carbon	0.01% OC
Bulk Density	n/a
%Moisture	n/a
%Lipids	n/a
Mercury	30 µg/kg

Table 13-5. Target MRLs for PCBs in Water, Sediment and Caulk

Congener	Water MRL (µg/L)	Sediment MRL (µg/kg)	Caulk/Sealant MRL (µg/kg)
PCB 8	0.002	0.2	0.5
PCB 18	0.002	0.2	0.5
PCB 28	0.002	0.2	0.5
PCB 31	0.002	0.2	0.5
PCB 33	0.002	0.2	0.5
PCB 44	0.002	0.2	0.5
PCB 49	0.002	0.2	0.5
PCB 52	0.002	0.2	0.5
PCB 56	0.002	0.2	0.5
PCB 60	0.002	0.2	0.5
PCB 66	0.002	0.2	0.5
PCB 70	0.002	0.2	0.5
PCB 74	0.002	0.2	0.5
PCB 87	0.002	0.2	0.5
PCB 95	0.002	0.2	0.5
PCB 97	0.002	0.2	0.5
PCB 99	0.002	0.2	0.5
PCB 101	0.002	0.2	0.5
PCB 105	0.002	0.2	0.5
PCB 110	0.002	0.2	0.5
PCB 118	0.002	0.2	0.5
PCB 128	0.002	0.2	0.5
PCB 132	0.002	0.2	0.5
PCB 138	0.002	0.2	0.5
PCB 141	0.002	0.2	0.5
PCB 149	0.002	0.2	0.5
PCB 151	0.002	0.2	0.5
PCB 153	0.002	0.2	0.5
PCB 156	0.002	0.2	0.5
PCB 158	0.002	0.2	0.5
PCB 170	0.002	0.2	0.5
PCB 174	0.002	0.2	0.5
PCB 177	0.002	0.2	0.5
PCB 180	0.002	0.2	0.5
PCB 183	0.002	0.2	0.5
PCB 187	0.002	0.2	0.5
PCB 194	0.002	0.2	0.5
PCB 195	0.002	0.2	0.5
PCB 201	0.002	0.2	0.5
PCB 203	0.002	0.2	0.5

Table 13-6. Size Distribution Categories for Grain Size in Sediment

Wentworth Size Category	Size	MRL
Clay	<0.0039 mm	1%
Silt	0.0039 mm to <0.0625 mm	1%
Sand, very fine	0.0625 mm to <0.125 mm	1%
Sand, fine	0.125 mm to <0.250 mm	1%
Sand, medium	0.250 mm to <0.5 mm	1%
Sand, coarse	0.5 mm to < 1.0 mm	1%
Sand, very coarse	1.0 mm to < 2 mm	1%
Gravel	2 mm and larger	1%

Table 13-7. Target MRLs for TOC, SSC, and Mercury in Water

Analyte	MRL
Total Organic Carbon	0.6 mg/L
Suspended Sediment Concentration	0.5 mg/L
Mercury	0.0002 µg/L

Table 13-8. Corrective Action – Laboratory and Field Quality Control

Laboratory Quality Control	Recommended Corrective Action
Calibration	Recalibrate the instrument. Affected samples and associated quality control must be reanalyzed following successful instrument recalibration.
Calibration Verification	Reanalyze the calibration verification to confirm the result. If the problem continues, halt analysis and investigate the source of the instrument drift. The analyst should determine if the instrument must be recalibrated before the analysis can continue. All of the samples not bracketed by acceptable calibration verification must be reanalyzed.
Laboratory Blank	Reanalyze the blank to confirm the result. Investigate the source of contamination. If the source of the contamination is isolated to the sample preparation, the entire batch of samples, along with the new laboratory blanks and associated QC samples, should be prepared and/or re-extracted and analyzed. If the source of contamination is isolated to the analysis procedures, reanalyze the entire batch of samples. If reanalysis is not possible, the associated sample results must be flagged to indicate the potential presence of the contamination.
Reference Material	Reanalyze the reference material to confirm the result. Compare this to the matrix spike/matrix spike duplicate recovery data. If adverse trends are noted, reprocess all of the samples associated with the batch.
Matrix Spike	The spiking level should be near the midrange of the calibration curve or at a level that does not require sample dilution. Reanalyze the matrix spike to confirm the result. Review the recovery obtained for the matrix spike duplicate. Review the results of the other QC samples (such as reference materials) to determine if other analytical problems are a potential source of the poor spike recovery.
Matrix Spike Duplicate	The spiking level should be near the midrange of the calibration curve or at a level that does not require sample dilution. Reanalyze the matrix spike duplicate to confirm the result. Review the recovery obtained for the matrix spike. Review the results of the other QC samples (such as reference materials) to determine if other analytical problems are a potential source of the poor spike recovery.
Internal Standard	Check the response of the internal standards. If the instrument continues to generate poor results, terminate the analytical run and investigate the cause of the instrument drift.
Surrogate	Analyze as appropriate for the utilized method. Troubleshoot as needed. If no instrument problem is found, samples should be re-extracted and reanalyzed if possible.
Field Quality Control	Recommended Corrective Action
Field Duplicate	Visually inspect the samples to determine if a high RPD between results could be attributed to sample heterogeneity. For duplicate results due to matrix heterogeneity, or where ambient concentrations are below the reporting limit, qualify the results and document the heterogeneity. All failures should be communicated to the project coordinator, who in turn will follow the process detailed in the method.
Field Blank	Investigate the source of contamination. Potential sources of contamination include sampling equipment, protocols, and handling. The laboratory should report evidence of field contamination as soon as possible so corrective actions can be implemented. Samples collected in the presence of field contamination should be flagged.

14. Inspection/Acceptance for Supplies and Consumables

Each sampling event conducted for the Monitoring Program will require use of appropriate consumables to reduce likelihood of sample contamination. The Field-PM will be responsible for ensuring that all supplies are appropriate prior to their use. Inspection requirements for sampling consumables and supplies are summarized in Table 14-1.

Table 14-1. Inspection / Acceptance Testing Requirements for Consumables and Supplies

Project-related Supplies	Inspection / Testing Specifications	Acceptance Criteria	Frequency	Responsible Person Sampling Containers
Sampling supplies	Visual	Appropriateness; no evident contamination or damage; within expiration date	Each purchase	Field Crew Leader

15. Non Direct Measurements, Existing Data

No data from external sources are planned to be used with this project.

16. Data Management

As previously discussed, the Monitoring Program data management will conform to protocols dictated by the study designs (BASMAA 2017a, b). A summary of specific data management aspects is provided below.

16.1. Field Data Management

All field data will be reviewed for legibility and errors as soon as possible after the conclusion of sampling. All field data that is entered electronically will be hand-checked at a rate of 10% of entries as a check on data entry. Any corrective actions required will be documented in correspondence to the QA Officer.

16.2. Laboratory Data Management

Record keeping of laboratory analytical data for the proposed project will employ standard record-keeping and tracking practices. All laboratory analytical data will be entered into electronic files by the instrumentation being used or, if data is manually recorded, then it will be entered by the analyst in charge of the analyses, per laboratory standard procedures.

Following the completion of internal laboratory quality control checks, analytical results will be forwarded electronically to the Field-PM. The analytical laboratories will provide data in electronic format, encompassing both a narrative and electronic data deliverable (EDD).

17. Assessments and Response Actions

17.1. Readiness Reviews

The Field-PM will review all field equipment, instruments, containers, and paperwork to ensure that everything is ready prior to each sampling event. All sampling personnel will be given a brief review of the goals and objectives of the sampling event and the sampling procedures and equipment that will be used to achieve them. It is important that all field equipment be clean and ready to use when it is needed. Therefore, prior to using all sampling and/or field measurement equipment, each piece of equipment will be checked to make sure that it is in proper working order. Equipment maintenance records will be checked to ensure that all field instruments have been properly maintained and that they are ready for use. Adequate supplies of all preservatives, bottles, labels, waterproof pens, etc. will be checked before each field event to make sure that there are sufficient supplies to successfully support each sampling event, and, as applicable, are within their expiration dates. It is important to make sure that all field activities and measurements are properly recorded in the field. Therefore, prior to starting each field event, necessary paperwork such as logbooks, chain of custody record forms, etc. will be checked to ensure that sufficient amounts are available during the field event. In the event that a problem is discovered during a readiness review it will be noted in the field log book and corrected before the field crew is deployed. The actions taken to correct the problem will also be documented with the problem in the field log book. This information will be communicated by the Field-PM prior to conducting relevant sampling. The Field-PM will track corrective actions taken.

17.2. Post Sampling Event Reviews

The Field-PM will be responsible for post sampling event reviews. Any problems that are noted will be documented along with recommendations for correcting the problem. Post sampling event reviews will be conducted following each sampling event in order to ensure that all information is complete and any deviations from planned methodologies are documented. Post sampling event reviews will include field sampling activities and field measurement documentation in order to help ensure that all information is complete. The reports for each post sampling event will be used to identify areas that may be improved prior to the next sampling event.

17.3. Laboratory Data Reviews

The Field-PM will be responsible for reviewing the laboratory's data for completeness and accuracy. The data will also be checked to make sure that the appropriate methods were used and that all required QC data was provided with the sample analytical results. Any laboratory data that is discovered to be incorrect or missing will immediately be reported to the both the laboratory and Consultant-PM. The laboratory's QA manual details the procedures that will be followed by laboratory personnel to correct any invalid or missing data. The Consultant-PM has the authority to request re-testing if a review of any of the laboratory data is found to be invalid or if it would compromise the quality of the data and resulting conclusions from the proposed project.

18. Instrument/Equipment Testing, Inspection and Maintenance

18.1. Field Equipment

Field measurement equipment will be checked for operation in accordance with manufacturer's specifications. All equipment will be inspected for damage when first employed and again when returned from use. Maintenance logs will be kept and each applicable piece of equipment will have its own log that documents the dates and description of any problems, the action(s) taken to correct problem(s), maintenance procedures, system checks, follow-up maintenance dates, and the person responsible for maintaining the equipment.

18.2. Laboratory Equipment

All laboratories providing analytical support for chemical or biological analyses will have the appropriate facilities to store, prepare, and process samples. Moreover, appropriate instrumentation and staff to provide data of the required quality within the schedule required by the program are also required. Laboratory operations must include the following procedures:

- A program of scheduled maintenance of analytical balances, microscopes, laboratory equipment, and instrumentation.
- Routine checking of analytical balances using a set of standard reference weights (American Society of Testing and Materials (ASTM) Class 3, NIST Class S-1, or equivalents).
- Checking and recording the composition of fresh calibration standards against the previous lot, wherever possible. Acceptable comparisons are < 2% of the previous value.
- Recording all analytical data in bound (where possible) logbooks, with all entries in ink, or electronic format.
- Monitoring and documenting the temperatures of cold storage areas and freezer units once per week.
- Verifying the efficiency of fume hoods.
- Having a source of reagent water meeting ASTM Type I specifications (ASTM, 1984) available in sufficient quantity to support analytical operations. The conductivity of the reagent water will not exceed 18 megaohms at 25°C. Alternately, the resistivity of the reagent water will exceed 10 mmhos/cm.
- Labeling all containers used in the laboratory with date prepared, contents, initials of the individual who prepared the contents, and other information, as appropriate.
- Dating and safely storing all chemicals upon receipt. Proper disposal of chemicals when the expiration date has passed.
- Having QAPP, SOPs, analytical methods manuals, and safety plans readily available to staff.
- Having raw analytical data, such as chromatograms, accessible so that they are available upon request.

Laboratories will maintain appropriate equipment per the requirements of individual laboratory SOPs and will be able to provide information documenting their ability to conduct the analyses with the required level of data quality. Such information might include results from interlaboratory comparison studies, control charts and summary data of internal QA/QC checks, and results from certified reference material analyses.

19. Instrument/Equipment Calibration and Frequency

19.1. Field Measurements

Any equipment used should be visually inspected during mobilization to identify problems that would result in loss of data. As appropriate, equipment-specific SOPs should be consulted for equipment calibration.

19.2. Laboratory Analyses

19.2.1. In-house Analysis – XRF Screening

A portable XRF analyzer will be used as a screening tool to estimate the chlorine concentration in each caulk sample. Since caulk often contains in excess of 1% PCBs and detection limits of portable XRF may be in the ppm range, the portable XRF may be able to detect chlorine within caulk containing PCBs down to about 0.1%. The analysis will be performed on the field samples using a test stand. The analyzer will be calibrated for chlorine using plastic pellet European reference materials (EC680 and EC681) upon first use, and standardized each time the instrument is turned on and prior to any caulk Cl analysis. The standardization procedure will entail a calibration analysis of the materials provided/recommended with the XRF analyzer. Analyses will be conducted in duplicate on each sample and notes kept. The mean will be used for comparison to GC–MS results.

19.2.2. Contract Laboratory Analyses

The procedures for and frequency of calibration will vary depending on the chemical parameters being determined. Equipment is maintained and checked according to the standard procedures specified in each laboratory's instrument operation instruction manual.

Upon initiation of an analytical run, after each major equipment disruption, and whenever on-going calibration checks do not meet recommended DQOs (see Section 13), analytical systems will be calibrated with a full range of analytical standards. Immediately after this procedure, the initial calibration must be verified through the analysis of a standard obtained from a different source than the standards used to calibrate the instrumentation and prepared in an independent manner and ideally having certified concentrations of target analytes of a CRM or certified solution. Frequently, calibration standards are included as part of an analytical run, interspersed with actual samples.

Calibration curves will be established for each analyte and batch analysis from a calibration blank and a minimum of three analytical standards of increasing concentration, covering the range of expected sample concentrations. Only those data resulting from quantification within the demonstrated working calibration range may be reported by the laboratory.

The calibration standards will be prepared from reference materials available from the EPA repository, or from available commercial sources. The source, lot number, identification, and purity of each reference material will be recorded. Neat compounds will be prepared weight/volume using a calibrated analytical balance and Class A volumetric flasks. Reference solutions will be diluted using Class A volumetric glassware. Individual stock standards for each analyte will be prepared. Combination working standards will be prepared by volumetric dilution of the stock standards. The calibration standards will be stored at -20° C. Newly prepared standards will be compared with existing standards prior to their use. All solvents

used will be commercially available, distilled in glass, and judged suitable for analysis of selected chemicals. Stock standards and intermediate standards are prepared on an annual basis and working standards are prepared every three months.

Sampling and analytical logbooks will be kept to record inspections, calibrations, standard identification numbers, the results of calibrations, and corrective action taken. Equipment logs will document instrument usage, maintenance, repair and performance checks. Daily calibration data will be stored with the raw sample data

20. Data Review, Verification, and Validation

Defining data review, verification, and validation procedures helps to ensure that Monitoring Plan data will be reviewed in an objective and consistent manner. Data review is the in-house examination to ensure that the data have been recorded, transmitted, and processed correctly. The Field-PM will be responsible for initial data review for field forms and field measurements; QA Officer will be responsible for doing so for data reported by analytical laboratories. This includes checking that all technical criteria have been met, documenting any problems that are observed and, if possible, ensuring that deficiencies noted in the data are corrected.

In-house examination of the data produced from the proposed Monitoring Program will be conducted to check for typical types of errors. This includes checking to make sure that the data have been recorded, transmitted, and processed correctly. The kinds of checks that will be made will include checking for data entry errors, transcription errors, transformation errors, calculation errors, and errors of data omission.

Data generated by Program activities will be reviewed against MQOs that were developed and documented in Section 13. This will ensure that the data will be of acceptable quality and that it will be SWAMP-comparable with respect to minimum expected MQOs.

QA/QC requirements were developed and documented in Sections 13.1 and 13.2, and the data will be checked against this information. Checks will include evaluation of field and laboratory duplicate results, field and laboratory blank data, matrix spike recovery data, and laboratory control sample data pertinent to each method and analytical data set. This will ensure that the data will be SWAMP-comparable with respect to quality assurance and quality control procedures.

Field data consists of all information obtained during sample collection and field measurements, including that documented in field log books and/or recording equipment, photographs, and chain of custody forms. Checks of field data will be made to ensure that it is complete, consistent, and meets the data management requirements that were developed and documented in Section 13.1.

Lab data consists of all information obtained during sample analysis. Initial review of laboratory data will be performed by the laboratory QA/QC Officer in accordance with the lab's internal data review procedures. However, upon receipt of laboratory data, the Lab-PM will perform independent checks to ensure that it is complete, consistent, and meets the data management requirements that were developed and documented in Section 13.2. This review will include evaluation of field and laboratory QC data and also making sure that the data are reported in compliance with procedures developed and documented in Section 7.

Data verification is the process of evaluating the completeness, correctness, and conformance / compliance of a specific data set against the method, procedural, or contractual specifications. The Lab-PM and Data Manager will conduct data verification, as described in Section 13 on Quality Control, in order to ensure that it is SWAMP-comparable with respect to completeness, correctness, and conformance with minimum requirements.

Data will be separated into three categories for use with making decisions based upon it. These categories are: (1) data that meets all acceptance requirements, (2) data that has been determined to be unacceptable for use, and (3) data that may be conditionally used and that is flagged as per US EPA specifications.

21. Verification and Validation Methods

Defining the methods for data verification and validation helps to ensure that Program data are evaluated objectively and consistently. For the proposed Program many of these methods have been described in Section 20. Additional information is provided below.

All data records for the Monitoring Program will be checked visually and will be recorded as checked by the checker's initials as well as with the dates on which the records were checked. Consultant Team staff will perform an independent re-check of at least 10% of these records as the validation methodology.

All of the laboratory's data will be checked as part of the verification methodology process. Each contract laboratory's Project Analyst will conduct reviews of all laboratory data for verification of their accuracy.

Any data that is discovered to be incorrect or missing during the verification or validation process will immediately be reported to the Consultant-PM. If errors involve laboratory data then this information will also be reported to the laboratory's QA Officer. Each laboratory's QA manual details the procedures that will be followed by laboratory personnel to correct any invalid or missing data. The laboratory's QA Officer will be responsible for reporting and correcting any errors that are found in the data during the verification and validation process.

If there are any data quality problems identified, the QA Officer will try to identify whether the problem is a result of project design issues, sampling issues, analytical methodology issues, or QA/QC issues (from laboratory or non-laboratory sources). If the source of the problems can be traced to one or more of these basic activities then the person or people in charge of the areas where the issues lie will be contacted and efforts will be made to immediately resolve the problem. If the issues are too broad or severe to be easily corrected then the appropriate people involved will be assembled to discuss and try to resolve the issue(s) as a group. The QA Officer has the final authority to resolve any issues that may be identified during the verification and validation process.

22. Reconciliation with User Requirements

The purpose of the Monitoring Program is to comply with Provisions of the MRP and provide data that can be used to identify sources of PCBs to urban runoff, and to evaluate management action effectiveness in removing POCs from urban runoff in the Bay Area. The objectives of the Monitoring Program are to provide the following outcomes:

1. Satisfy MRP Provision C.8.f. requirements for POC monitoring for source identification;

2. Satisfy MRP Provision C.12.e.ii requirements to evaluate PCBs presence in caulks/sealants used in storm drain or roadway infrastructure in public ROWs;
3. Report the range of PCB concentrations observed in 20 composite samples of caulk/sealant collected from structures installed or rehabilitated during the 1970's;
4. Satisfy MRP Provision C.8.f. requirements for POC monitoring for management action effectiveness;
5. Quantify the annual mass of mercury and PCBs captured in HDS Unit sumps during maintenance; and
6. Identify BSM mixtures for future field testing that provide the most effective mercury and PCBs treatment in laboratory column tests.

Information from field data reports (including field activities, post sampling events, and corrective actions), laboratory data reviews (including errors involving data entry, transcriptions, omissions, and calculations and laboratory audit reports), reviews of data versus MQOs, reviews against QA/QC requirements, data verification reports, data validation reports, independent data checking reports, and error handling reports will be used to determine whether or not the Monitoring Program's objectives have been met. Descriptions of the data will be made with no extrapolation to more general cases.

Data from all monitoring measurements will be summarized in tables. Additional data may also be represented graphically when it is deemed helpful for interpretation purposes.

The above evaluations will provide a comprehensive assessment of how well the Program meets its objectives. The final project reports will reconcile results with project MQOs.

23. References

California Regional Water Quality Control Board, San Francisco Bay Region. *Municipal Regional Stormwater NPDES Permit Order R2-2015-0049 NPDES Permit No. CAS612008*. November 19, 2015.

BASMAA. 2016. *BASMAA Regional Monitoring Coalition Creek Status and Toxicity and Pesticide Monitoring Standard Operating Procedures*. Prepared for Bay Area Stormwater Management Agencies Association. Version 3, March 2016.

BASMAA 2017a. *The Evaluation of PCBs Presence in Public Roadway and Storm Drain Infrastructure Caulk and Sealants Study Design*. Prepared by EOA Inc. and the San Francisco Estuary Institute (SFEI). June 2017.

BASMAA 2017b. *POC Monitoring for Management Action Effectiveness Study Design*. Prepared by the Office of Water Programs, Sacramento State, CA, EOA Inc., and the San Francisco Estuary Institute (SFEI). July 2017.

BASMAA, 2017c. *Clean Watershed for a Clean Bay (CW4CB) Final Report*. Prepared for Bay Area Stormwater Management Agencies Association. Prepared by Geosyntec and EOA, Inc., May 2017.

Klosterhaus, S. McKee, L.J. Yee, D., Kass, J.M., and Wong, A. 2014. Polychlorinated Biphenyls in the Exterior Caulk of San Francisco Bay Area Buildings, California, USA. *Environment International* 66, 38-43.

Surface Water Ambient Monitoring Program Quality Assurance Team, 2013. *SWAMP Quality Assurance Project Plan*. Prepared for the California State Water Quality Control Board. 2013.

24. Appendix A: Field Documentation

Caulk/Sealant Sampling Field Data Sheet			Composite ID:			Contractor:			Pg of Pgs				
Sample ID:			Date (mm/dd/yyyy):				Personnel:			Failure Reason			
Photos (Y / N)			ArrivalTime:		DepartureTime:								
Photo Log Identifier			Land-Use at the Sample Location:			Commercial (pre-1980; post 1980)			Open Space				
			Industrial (pre-1980; post-1980)			Residential (pre 1980; post 1980)			Other:				
Description of Structure: (Do not include any information on the location of the structure)						Diagram of Structure (if needed) to identify where caulk/sealants were located in/on structure							
Structure Type:		Storm Drain Catch Basin	Roadway Surface		Sidewalk	Curb/Gutter	Bridge						
		Other:											
Structure Material:		Concrete	Asphalt		Other:								
Condition of Structure:		Good	Fair		Poor	Other:							
Year of Structure Construction													
Year of Repair													
Description of Caulk or Sealant Sample Collected:													
Application or Usage		Caulk	caulk between adjoining surfaces of same material (e.g., concrete-concrete); Describe:										
			caulk between adjoining surfaces of different types of material (e.g., concrete-asphalt); Describe:										
			Other:										
		Sealant	Crack Repair (describe):										
Other:													
Color													
Texture		Hard/brittle	Soft/pliable		Other:								
Condition		Good (intact/whole)		Poor (crumbling/disintegrating)			Other:						
Location		Surface	Between Joints		Submerged	Exposed	At street level	Below street level		Other:			
Amount of Caulk/Sealant observed on structure		Crack dimensions:					Spacing of expansion joints						
		Length&width of caulk bead sampled:					Other:						
Samples Taken													
COLLECTION DEVICE:						Equipment type used:							
SITE/SAMPLING DESCRIPTION AND COMMENTS:													

HDS Unit Sampling Field Data Sheet (Sediment Chemistry)				Contractor:		Pg		of		Pgs	
City:		Date (mm/dd/yyyy):		/ /		*Contractor:					
HDS Catchment ID:		ArrivalTime:		DepartureTime:		*SampleTime (1st sample):			Failure Reason		
		Personnel:									
Photos (Y / N)		*GPS/DGPS	Lat (dd.ddddd)	Long (ddd.ddddd)	Address, Location, and Sketches (if needed)						
Photo Log Identifier		Target (if known):									
		*Actual:									
		GPS Device:									
		Estimate of Volume of Sediment in the HDS unit sump prior to cleanout:									
Estimate of Volume of Sediment REMOVED from the HDS unit sump during the cleanout:											
Env. Conditions			WIND DIRECTION (from):								
SITE ODOR:	None, Sulfides, Sew age, Petroleum, Smoke, Other _____										
SKY CODE:	Clear, Partly Cloudy, Overcast, Fog, Smoky, Hazy										
PRECIP:	None, Fog, Drizzle, Rain										
PRECIP (last 24 hrs):	Unknow n, <1", >1", None										
SOILODOR:	None, Sulfides, Sew age, Petroleum, Mixed, Other _____										
SOILCOLOR:	Colorless, Green, Yellow, Brown										
SOILCOMPOSITION:	Silt/Clay, Sand, Gravel, Cobble, Mixed, Debris										
SOILPOSITION:	Submerged, Exposed										
Samples Taken (3 digit ID nos. of containers filled)				Field Dup at Site? YES / NO: (create separate datasheet for FDs, with unique IDs (i.e., blind samples))							
COLLECTION DEVICE:		Equipment type used: Scoop (SS / PC / PE), Core (SS / PC / PE), Grab (Van Veen / Eckman / Petite Ponar), Broom (nylon, natural fiber)									
Sample ID (City-Catchment ID-Sample)	Depth Collec (cm)	Composite / Grab (C / G)	Grain Size	PCBs	Hg	Bulk Density	TOC	OTHER			
SITE/SAMPLING DESCRIPTION AND COMMENTS:											

Stormwater Influent Samples – Office of Water Programs

Sample Receiving						
Date (mm/dd/yy):			Time (24 hr) :		Team Member's Initial:	
Carboy	Temperature	pH	Observations			
1						
2						
3						
4						
5						
6						
7						

25. Appendix B: Laboratory Standard Operating Procedures (SOPs)



APPENDIX C: QA SUMMARY REPORTS

QA Summary Report for ALS Analysis of PCBs in Sediment and Tissue HDS samples for the Pollutants of Concern Monitoring for Source Identification and Management Action Effectiveness Study, 2017-2018

Prepared By Don Yee, SFEI QA Officer, for BASMAA Regional Monitoring Coalition

November 12, 2018

QA Issues for Project Manager to Review
None.

Reporting Issues for Lab to Review
None.

Hold time review (especially desired by stormwater programs)
One sample was analyzed ~1week past the 1 year recommended hold times for PCBs, and flagged VH, but it is unlikely to affect results severely.

QA Review

Completeness

Data were reported for 8 field samples, 3 as sediment and 5 as tissue, analyzed for the RMP 40 PCBs with 38 unique analytes (including coeluters). 3 lab blanks, and 5 LCS samples were also reported, for the 38 target analyte individual congeners or coeluter groups.

Percent usable (non-reject) field data

98% of the data were reportable, with 2% of the data (one analyte) rejected for poor recovery issues.

Overall acceptability

Overall the data were acceptable, with one sample flagged for hold time about 1 week too long, and one analyte (PCB 183/185) with poor LCS recovery. Several other PCB congeners/groups were flagged for recovery deviations >35%, or for detection in blank samples, but none of them were severe enough to be censored.

MDLs sensitivity

Overall about 5% of the analyte results were non-detect, with another 3% flagged as estimated due to being under the reporting limit.

QB averages (procedural, field blank)

8 analytes/coeluting groups were detected in blanks. Field sample concentrations were always at least 3x higher, so no results were censored.

Average precision from replicate field sample

Precision was calculated using the LCS replicates, with only PCB 183/185 showing RSDs averaging 53%, which was flagged but not censored.

Accuracy (using a variety of SRMs or Matrix spike QRECs)

However, PCB 183/185 recovery averaged 75% error, so was censored for being over 2x outside the target range (>70%, with a target of 35% error). PCB 158 and 105 were also flagged for marginal recovery but not censored.

Comparison of dissolved and total phases

Not applicable.

Summary paragraph for report:

The HDS sediment/tissue dataset included 8 field samples, with 3 blanks, and 5 LCSs (some in duplicate), meeting the minimum number of QC samples required, reported for the RMP 40 PCB analytes (with their coeluters, yielding 38 unique analytes). All but 1 Sample was analyzed within the recommended hold time of 1 year (the last ~1 week late). 8 of the analytes were detected in blanks, but field sample concentrations were over 3x higher, so no results were censored. Two of the analytes had recovery with average >35% deviation from target values in the LCS, and one (PCB 183/185) had average error >70%, so was censored. PCB 183/185 was also flagged for poor precision (RSD 53%), but that analyte was already rejected for poor recovery, so the precision flag is largely moot.

QA Summary Report for ALS Analysis of Hg, TOC, TS and Density in HDS Sediment and Tissue samples for the Pollutants of Concern Monitoring for Source Identification and Management Action Effectiveness Study, 2017-2018

Prepared By Don Yee, SFEI QA Officer, for BASMAA Regional Monitoring Coalition

November 14, 2018

QA Issues for Project Manager to Review

None.

Reporting Issues for Lab to Review

Review with lab formatting convention for lab reps - increment lab replicate not replicate if using CEDEN conventions.

Hold time review (especially desired by stormwater programs)

Nearly all samples were past the 1 week QAPP listed hold times for density and total solids, and flagged VH. However, so long as initial masses were recorded well, it is unlikely to affect results severely.

QA Review

Completeness

Eight field samples were reported for density and Hg as 3 sediment and 5 tissue samples. TOC was reported for 7 samples, with 2 field replicates, and no result for SJC-604. Total solids was reported twice for all the sediment samples and once each for the tissue ones, and total volatile solids was reported for 4 of the tissue samples (skipping SJ-604). MS/D pairs were reported for 2 sites for TOC, and 2 for Hg. 9 lab blanks were reported for mercury, and 6 for TOC, meeting the 1 per batch requirement. 3 LCSs were also reported for TOC.

Percent usable (non-reject) field data

All of the data were reportable, with none rejected/censored.

Overall acceptability

Overall the data were acceptable, with all but 1 density and total solids samples flagged for hold time beyond the 1 week listed in the BASMAA POC QAPP. If initial sample weights are recorded well though, dessication in storage or other artifacts of extended storage can be corrected for/will be minor.

MDLs sensitivity

No results were non-detect.

QB averages (procedural, field blank)

Only Hg was occasionally detected in the blanks, but concentrations averaged <MDL so results were not flagged.

Average precision from replicate field sample

Precision on the field sample replicates for TOC and total solids, averaged <5% RPD. RPD on the MS/Ds for mercury averaged <10%, well within the target 25%, so no precision flags were added.

Accuracy (using a variety of SRMs or Matrix spike QRECs)

Recovery errors on MS/Ds averaged 2% for TOC and 15% for Hg, well within their respective $\pm 20\%$ and $\pm 25\%$ QAPP targets, so no recovery flags were added.

Comparison of dissolved and total phases

Not applicable.

Summary paragraph for report:

The HDS sediment/tissue dataset included 8 field samples reported for Hg, total solids, and density, but only 7 for TOC and 4 tissue ones for total volatile solids (missing SJC-604). MS/D pairs were reported for 2 sites for TOC, and Hg. 9 lab blanks were reported for mercury, and 6 for TOC, meeting the 1 per batch requirement. 3 LCSs were also reported for TOC. Nearly all density and total solids were analyzed past the 1 week QAPP listed hold times, and flagged VH, but so long as initial masses were recorded well, it is unlikely to affect results severely. Only Hg was occasionally detected in the blanks, but averaged <MDL so results were not flagged. Precision (<25% RPD) and recovery targets ($\pm 20\%$ for conventional analytes and $\pm 25\%$ for Hg) were met for all QC samples, so no other flags were added.

QA Summary Report for ALS Analysis of Grain Size in Sediment HDS samples for the Pollutants of Concern Monitoring for Source Identification and Management Action Effectiveness Study, 2017-2018

Prepared By Don Yee, SFEI QA Officer, for BASMAA Regional Monitoring Coalition

November 19, 2018

QA Issues for Project Manager to Review

ALS Lab reported all grainsize by their usual convention relative to dw estimated from separate moisture measurement (rather than summed fraction weights of processed sample), yielding sums of fractions not 100%. Results were recalculated to normalize to a sum of 100%. The smaller size fractions approximately match the Wentworth cutoffs (powers of 2 below 31.3, 15.6, etc), but the next size fraction up is 75um rather than 62.5, and the coarser fractions are listed just by analytename (e.g. Sand, Very Fine) without any indication of size range, which could differ between Wentworth and ASTM scales.

Reporting Issues for Lab to Review

Review with lab formatting convention for lab reps - increment lab replicate not replicate if using CEDEN conventions.

Hold time review (especially desired by stormwater programs)

All samples were analyzed within the project QAPP specified 28 days.

QA Review

Completeness

Three field samples were reported analyzed in replicate for 14 grainsize fractions.

Percent usable (non-reject) field data

All of the data were reportable, with none rejected/censored.

Overall acceptability

Overall the data were acceptable. Many fractions are only a few percent of total mass, so comparing replicates based on RPD (relative percent difference) of a small percentage to start with is inappropriate. Replicates are thus compared on raw differences in reported percentage per fraction. Percent difference in replicates <5% for all fractions, so no results were qualified..

MDLs sensitivity

No results were non-detect.

QB averages (procedural, field blank)

No blanks were run, which is common for grainsize analysis.

Average precision from replicate field sample

Differences on the sample replicates for grainsize were all nominally <5%. so no precision flags were added. Many fractions are only a few percent of total mass, so comparing replicates based on RPD (relative percent difference) of a small percentage to start with would be inappropriate.

Accuracy (using a variety of SRMs or Matrix spike QRECs)

No recovery samples were run, which is common for grainsize analysis.

Comparison of dissolved and total phases

Not applicable.

Comparison to previous years

Not applicable

Ratio Checking Summary

Not applicable

Sums Summary

All grainsize fractions summed to 100% for each sample and within each lab replicate analysis (after normalization).

Summary paragraph for report:

The HDS sediment dataset included 3 field samples reported for grainsize, all analyzed in replicate. No blanks or recovery samples were reported, which is common for grainsize analysis. Fourteen size fractions were reported, with results normalized from the raw lab reported percentages to yield sums of 100% for each analysis. Nominal percent differences in lab replicates for any given sample were always <5%, so no qualifier flags were added.



APPENDIX D: PCBs CONGENERS CONCENTRATION DATA

HDS Site ID	Station Code	Sample Date	Collection Time	Matrix	PCB Congener(s)	PCB Concentration (ng/kg dw)
1	SUN-MatCDS1	3/8/2018	9:10 AM	Sediment + Organic Debris	PCB 008	566
					PCB 018/30	1,528
					PCB 020/28	3,736
					PCB 021/33	2,043
					PCB 031	2,791
					PCB 044/47/65	2,994
					PCB 049/69	1,902
					PCB 052	3,485
					PCB 056	1,681
					PCB 060	896
					PCB 066	3,472
					PCB 070/61/74/76	4,337
					PCB 083/99	963
					PCB 086/87/97/109/119/125	1,178
					PCB 090/101/113	1,552
					PCB 093/95/100	1,411
					PCB 105	632
					PCB 110/115	2,006
					PCB 118	1,190
					PCB 128/166	323
					PCB 129/138/163	2,883
					PCB 132	644
					PCB 135/151/154	767
					PCB 141	353
					PCB 147/149	1,564
					PCB 153/168	1,785
					PCB 156/157	249
					PCB 158	190
					PCB 170	442
					PCB 174	663
PCB 177	340					
PCB 180/193	1,583					
PCB 183/185	554					
PCB 187	1,350					
PCB 194	491					
PCB 195	172					
PCB 201	156					
PCB 203	663					

HDS Site ID	Station Code	Sample Date	Collection Time	Matrix	PCB Congener(s)	PCB Concentration (ng/kg dw)
2	SUN-MatCDS2	3/8/2018	9:45 AM	Sediment + Organic Debris	PCB 008	359
					PCB 018/30	583
					PCB 020/28	863
					PCB 021/33	249
					PCB 031	842
					PCB 044/47/65	1,331
					PCB 049/69	1,072
					PCB 052	2,662
					PCB 056	240
					PCB 060	142
					PCB 066	635
					PCB 070/61/74/76	1,043
					PCB 083/99	806
					PCB 086/87/97/109/119/125	971
					PCB 090/101/113	1,482
					PCB 093/95/100	1,353
					PCB 105	530
					PCB 110/115	1,691
					PCB 118	1,151
					PCB 128/166	396
					PCB 129/138/163	3,094
					PCB 132	748
					PCB 135/151/154	928
					PCB 141	417
					PCB 147/149	2,072
					PCB 153/168	2,266
					PCB 156/157	224
					PCB 158	201
					PCB 170	770
					PCB 174	1,410
PCB 177	641					
PCB 180/193	3,683					
PCB 183/185	1,281					
PCB 187	3,007					
PCB 194	1,806					
PCB 195	528					
PCB 201	415					
PCB 203	2,000					

HDS Site ID	Station Code	Sample Date	Collection Time	Matrix	PCB Congener(s)	PCB Concentration (ng/kg dw)
3	OAK-5-G	10/16/2017	10:20 AM	sediment	PCB 008	394
					PCB 018/30	710
					PCB 020/28	821
					PCB 021/33	161
					PCB 031	752
					PCB 044/47/65	1,500
					PCB 049/69	900
					PCB 052	2,480
					PCB 056	548
					PCB 060	ND
					PCB 066	26
					PCB 070/61/74/76	2,500
					PCB 083/99	3,060
					PCB 086/87/97/109/119/125	4,550
					PCB 090/101/113	5,890
					PCB 093/95/100	4,150
					PCB 105	3,830
					PCB 110/115	8,890
					PCB 118	8,680
					PCB 128/166	2,380
					PCB 129/138/163	13,000
					PCB 132	3,190
					PCB 135/151/154	2,610
					PCB 141	1,630
					PCB 147/149	4,940
					PCB 153/168	7,080
					PCB 156/157	1,720
					PCB 158	ND
					PCB 170	80
					PCB 174	1,330
PCB 177	ND					
PCB 180/193	ND					
PCB 183/185	883					
PCB 187	1,560					
PCB 194	553					
PCB 195	211					
PCB 201	89					
PCB 203	535					

HDS Site ID	Station Code	Sample Date	Collection Time	Matrix	PCB Congener(s)	PCB
						Concentration (ng/kg dw)
4	OAK-5-D	2/2/2018	10:55 AM	sediment	PCB 008	ND
					PCB 018/30	1,150
					PCB 020/28	2,010
					PCB 021/33	1,070
					PCB 031	1,660
					PCB 044/47/65	5,590
					PCB 049/69	2,900
					PCB 052	9,710
					PCB 056	2,810
					PCB 060	739
					PCB 066	1,940
					PCB 070/61/74/76	12,300
					PCB 083/99	13,500
					PCB 086/87/97/109/119/125	22,200
					PCB 090/101/113	28,000
					PCB 093/95/100	21,200
					PCB 105	13,700
					PCB 110/115	45,800
					PCB 118	25,600
					PCB 128/166	9,820
					PCB 129/138/163	54,500
					PCB 132	17,900
					PCB 135/151/154	16,000
					PCB 141	7,620
					PCB 147/149	28,600
					PCB 153/168	30,700
					PCB 156/157	5,760
					PCB 158	ND
					PCB 170	353
					PCB 174	ND
PCB 177	6,470					
PCB 180/193	ND					
PCB 183/185	4,280					
PCB 187	7,300					
PCB 194	2,720					
PCB 195	1,060					
PCB 201	520					
PCB 203	2,740					

HDS Site ID	Station Code	Sample Date	Collection Time	Matrix	PCB Congener(s)	PCB Concentration (ng/kg dw)
5	PAL-Meadow	10/25/2017	10:50 AM	Sediment + Organic Debris	PCB 008	139
					PCB 018/30	193
					PCB 020/28	321
					PCB 021/33	63
					PCB 031	335
					PCB 044/47/65	604
					PCB 049/69	513
					PCB 052	1,182
					PCB 056	98
					PCB 060	56
					PCB 066	287
					PCB 070/61/74/76	488
					PCB 083/99	431
					PCB 086/87/97/109/119/125	490
					PCB 090/101/113	682
					PCB 093/95/100	651
					PCB 105	307
					PCB 110/115	911
					PCB 118	656
					PCB 128/166	ND
					PCB 129/138/163	1,620
					PCB 132	339
					PCB 135/151/154	355
					PCB 141	168
					PCB 147/149	755
					PCB 153/168	953
					PCB 156/157	140
					PCB 158	113
					PCB 170	225
					PCB 174	264
PCB 177	141					
PCB 180/193	672					
PCB 183/185	219					
PCB 187	516					
PCB 194	227					
PCB 195	56					
PCB 201	52					
PCB 203	214					

HDS Site ID	Station Code	Sample Date	Collection Time	Matrix	PCB Congener(s)	PCB Concentration (ng/kg dw)
6	SJC-604	10/5/2017	10:35 AM	Sediment + Organic Debris	PCB 008	4,335
					PCB 018/30	5,822
					PCB 020/28	11,881
					PCB 021/33	3,990
					PCB 031	10,761
					PCB 044/47/65	12,893
					PCB 049/69	9,787
					PCB 052	18,317
					PCB 056	2,812
					PCB 060	1,726
					PCB 066	7,505
					PCB 070/61/74/76	12,475
					PCB 083/99	ND
					PCB 086/87/97/109/119/125	11,777
					PCB 090/101/113	15,545
					PCB 093/95/100	12,673
					PCB 105	7,492
					PCB 110/115	18,274
					PCB 118	16,142
					PCB 128/166	2,985
					PCB 129/138/163	27,208
					PCB 132	6,254
					PCB 135/151/154	7,046
					PCB 141	3,442
					PCB 147/149	15,838
					PCB 153/168	16,345
					PCB 156/157	2,366
					PCB 158	1,878
					PCB 170	3,446
					PCB 174	4,244
PCB 177	2,518					
PCB 180/193	7,238					
PCB 183/185	3,149					
PCB 187	5,990					
PCB 194	2,327					
PCB 195	779					
PCB 201	284					
PCB 203	1,777					

HDS Site ID	Station Code	Sample Date	Collection Time	Matrix	PCB Congener(s)	PCB Concentration (ng/kg dw)
7	SUN-27A	3/8/2018	11:15 AM	Sediment + Organic Debris	PCB 008	395
					PCB 018/30	401
					PCB 020/28	942
					PCB 021/33	149
					PCB 031	853
					PCB 044/47/65	1,410
					PCB 049/69	1,104
					PCB 052	2,578
					PCB 056	151
					PCB 060	78
					PCB 066	577
					PCB 070/61/74/76	989
					PCB 083/99	884
					PCB 086/87/97/109/119/125	898
					PCB 090/101/113	1,867
					PCB 093/95/100	1,458
					PCB 105	513
					PCB 110/115	1,795
					PCB 118	1,149
					PCB 128/166	517
					PCB 129/138/163	6,614
					PCB 132	1,434
					PCB 135/151/154	1,843
					PCB 141	970
					PCB 147/149	4,229
					PCB 153/168	4,807
					PCB 156/157	317
					PCB 158	445
					PCB 170	2,024
					PCB 174	2,675
PCB 177	1,470					
PCB 180/193	5,952					
PCB 183/185	1,952					
PCB 187	3,494					
PCB 194	1,102					
PCB 195	458					
PCB 201	213					
PCB 203	951					

HDS Site ID	Station Code	Sample Date	Collection Time	Matrix	PCB Congener(s)	PCB Concentration (ng/kg dw)
8	SJC-612-01	9/13/2017	1:53 PM	sediment	PCB 008	24
					PCB 018/30	36
					PCB 020/28	93
					PCB 021/33	42
					PCB 031	69
					PCB 044/47/65	175
					PCB 049/69	92
					PCB 052	295
					PCB 056	77
					PCB 060	42
					PCB 066	162
					PCB 070/61/74/76	444
					PCB 083/99	455
					PCB 086/87/97/109/119/125	683
					PCB 090/101/113	943
					PCB 093/95/100	729
					PCB 105	352
					PCB 110/115	1,270
					PCB 118	879
					PCB 128/166	204
					PCB 129/138/163	1,330
					PCB 132	410
					PCB 135/151/154	571
					PCB 141	217
					PCB 147/149	60
					PCB 153/168	843
					PCB 156/157	133
					PCB 158	125
					PCB 170	14
					PCB 174	ND
PCB 177	328					
PCB 180/193	ND					
PCB 183/185	211					
PCB 187	432					
PCB 194	186					
PCB 195	68					
PCB 201	33					
PCB 203	179					

Appendix 7

Regional Monitoring Program Pollutants of Concern Reconnaissance Monitoring Progress Report

Water Years 2015-2018

This page intentionally blank



RMP
REGIONAL MONITORING
PROGRAM FOR WATER QUALITY
IN SAN FRANCISCO BAY

sfei.org/rmp

Pollutants of Concern Reconnaissance Monitoring Progress Report, Water Years 2015 - 2018

Prepared by

Alicia Gilbreath, Jennifer Hunt and Lester McKee

SFEI

CONTRIBUTION NO. XXX / DECEMBER 2018

Preface

Reconnaissance monitoring for water years 2015, 2016, 2017 and 2018 was completed with funding provided by the Regional Monitoring Program for Water Quality in San Francisco Bay (RMP). This report is designed to be updated each year until completion of the study. At least one additional water year (2019) is planned for this study. This initial full draft report was prepared for the Bay Area Stormwater Management Agencies Association (BASMAA) in support of materials submitted on or before March 31st 2019 in compliance with the Municipal Regional Stormwater Permit (MRP) Order No. R2-2015-0049. This draft report may undergo updates following review by members of the Sources, Pathways, and Loadings Workgroup of the RMP in May 2019.

Acknowledgements

We appreciate the support and guidance from members of the Sources, Pathways, and Loadings Workgroup of the RMP. The detailed work plan behind this study was developed by the RMP Small Tributaries Loading Strategy (STLS) Team during a series of meetings in the summer of 2014, with slight modifications made during the summers of 2015, 2016, 2017, and 2018. Local members on the STLS Team at that time were Arleen Feng (Alameda Countywide Clean Water Program), Bonnie de Berry (San Mateo Countywide Water Pollution Prevention Program), Lucile Paquette (Contra Costa Clean Water Program), Chris Sommers and Lisa Sabin (Santa Clara Valley Urban Runoff Pollution Prevention Program), and Richard Looker and Jan O'Hara (Regional Water Board). RMP field and logistical support provided by San Francisco Estuary Institute (SFEI) over the first winter of the project included Patrick Kim, Carolyn Doehring, and Phil Trowbridge, in the second winter of the project included Patrick Kim, Amy Richey, and Jennifer Sun, in the winter of WY 2017 included Ila Shimabuku, Amy Richey, Steven Hagerty, Diana Lin, Margaret Sedlak, Jennifer Sun, Katie McKnight, Emily Clark, Don Yee, and Jennifer Hunt, and in the winter of WY 2018 included Ila Shimabuku, Margaret Sedlak, Jennifer Sun, Micha Salomon, and Don Yee. The RMP data management team is acknowledged for their diligent delivery of quality-assured well-managed data. This team was comprised of Amy Franz, Adam Wong, Michael Weaver, John Ross, and Don Yee in WYs 2015, 2016, 2017 and 2018. Helpful written reviews of this report were provided by members of BASMAA (Bonnie de Berry, EOA Inc. on behalf of the San Mateo Countywide Water Pollution Prevention Program; Lucile Paquette, Contra Costa Clean Water Program; Jim Scanlin, Alameda Countywide Clean Water Program); Barbara Mahler (USGS) and Richard Looker (SFBRWQCB).

Suggested citation:

Gilbreath, A.N., Hunt, J.A., and McKee, L.J., in preparation. Pollutants of Concern Reconnaissance Monitoring Progress Report, Water Years 2015-2018. A Technical Report prepared for the Regional Monitoring Program for Water Quality in San Francisco Bay (RMP). Contribution No. XXX. San Francisco Estuary Institute, Richmond, California.

Executive Summary

The San Francisco Bay polychlorinated biphenyl (PCB) and mercury (Hg) total maximum daily loads (TMDLs) call for implementation of control measures to reduce PCB and Hg loads entering the Bay via stormwater. In 2009, the San Francisco Bay Regional Water Quality Control Board (Regional Water Board) issued the first Municipal Regional Stormwater Permit (MRP). This MRP contained provisions aimed at improving information on stormwater pollutant loads in selected watersheds (Provision C.8.) and piloted a number of management techniques to reduce PCB and Hg loading to the Bay from smaller urbanized tributaries (Provisions C.11. and C.12.). In 2015, the Regional Water Board issued the second iteration of the MRP. “MRP 2.0” placed an increased focus on identifying those watersheds, source areas, and source properties that are potentially the most polluted and are therefore most likely to be cost-effective areas for addressing load-reduction requirements through implementation of control measures.

To support this increased focus, a stormwater reconnaissance monitoring field protocol was developed and implemented in water years (WYs) 2015, 2016, 2017 and 2018. Most of the sites monitored were in Alameda, Santa Clara, and San Mateo Counties, with a few sites in Contra Costa and Solano Counties. At the 60 sampling sites, time-weighted composite water samples were collected during individual storm events and analyzed for 40 PCB congeners, total Hg (HgT), and suspended sediment concentration (SSC). At a subset of sites, additional samples were analyzed for selected trace metals, organic carbon (OC), and grain size. Where possible, sampling efficiency was increased by sampling two or three sites during a single storm if the sites were near enough to one another that alternating between them was safe and rapid. This same field protocol is being implemented in the winter of WY 2019 by the RMP. The San Mateo Countywide Water Pollution Prevention Program and the Santa Clara Valley Urban Runoff Pollution Prevention Program are also implementing the sampling protocol with their own funding.

During this study beginning in WY 2015, the RMP began piloting the use of un-staffed “remote” suspended sediment samplers (Hamlin samplers and Walling Tube samplers). These remote samplers were designed to enhance settling and capture of suspended sediment from the water column. At 10 of the manual sampling sites, a remote sample was collected using a Hamlin suspended sediment sampler in parallel with the manual sample, and at 9 sites a remote sample was collected using a Walling Tube suspended sediment sampler in parallel with the manual sample.

Key Findings

Based on the WY 2015–18 monitoring, a number of sites with elevated PCB and Hg stormwater concentrations and estimated concentrations on particles were identified. Including RMP sampling prior to WY 2015, now 24 sites with estimated particle concentrations of PCBs greater than 200 ng/g and 31 sites with estimated particle concentrations of Hg greater than 0.5 µg/g have been identified. Total PCB concentrations measured in the composite water samples collected from the 83 sites ranged 840-fold, from 533 to 448,000 pg/L (excluding one sample where PCBs were below the detection limit). The three highest ranking sites for PCB whole-water concentrations were Pulgas Pump Station South (448,000 pg/L), Santa Fe Channel (198,000 pg/L), and Industrial Rd Ditch in San Carlos (160,000 pg/L). When normalized by SSC to generate estimated particle concentrations, the three sites with highest estimated

particle concentrations were Pulgas Pump Station South (8,222 ng/g), Industrial Rd Ditch in San Carlos (6,139 ng/g), and Line 12H at Coliseum Way in Oakland (2,601 ng/g).

Total Hg concentrations in samples collected in water years since 2003 ranged 112-fold, from 5.4 to 603 ng/L. The lower variation in HgT concentrations relative to PCBs is consistent with conceptual models for these substances (McKee et al., 2015). HgT is expected to be more uniformly distributed than PCBs because it has more widespread sources in the urban environment, the concentrations and mass used in industrial applications were relatively much smaller compared to industrial use of PCBs, and Hg has a larger atmospheric component to its cycle. The greatest HgT concentrations were measured at the Guadalupe River at Hwy 101 (603 ng/L), Guadalupe River at Foxworthy Road/Almaden (529 ng/L), and Zone 5 Line M (505 ng/L). The greatest estimated particle concentrations were measured at Guadalupe River at Foxworthy Road/Almaden (4.1 µg/g), Guadalupe River at Hwy 101 (3.6 µg/g), and the Outfall at Gilman St. in Berkeley (2.8 µg/g). Two of these stations are downstream of the historic New Almaden Mining District.

The sites with the highest particle concentrations for PCBs were typically not the sites with the highest concentrations for HgT. The ten highest ranking sites for PCBs based on estimated particle concentrations ranked 45th, 27th, 19th, 22nd, 51st, 39th, 65th, 36th, 14th, and 10th, respectively, for estimated HgT particle concentrations.

Remote Suspended Sediment Samplers

Results from the two remote suspended sediment sampler types used (Walling Tube sampler and Hamlin sampler) generally characterized sites similarly to the composite stormwater sampling methods. Sites with higher concentrations in the sediment collected by the remote samplers were the same as those with higher concentrations in the composite samples. Therefore, the remote samplers will be used in WY 2019 for preliminary screening of new sites to support decisions about further sampling.

In comparing the remote versus manual sampling methods, generally speaking, it is estimated that remote sampling methods are more cost-effective because they allow for many sites to be monitored during a single storm event without actually being present on site during the storm event. However, similar to manual sampling methods, there are initial costs to purchase the equipment, and labor is required to deploy and process samples. In addition, there will always be logistical constraints (such as turbulence, tidal influences, or hydraulic incompatibility) that complicate use of the remote devices and require manual monitoring at a particular site. The data collected using the remote sampling methodologies are generally useful for ranking sites for different pollutants but cannot be used for load calculations. Therefore, the remote sampling method may best be used as a companion to manual monitoring methods to reduce costs and collect data for other purposes, providing a cost-effective site screening field monitoring protocol to support decisions about further sampling.

Further Data Interpretations

Relationships between the PCB and HgT estimated particle concentrations, watershed characteristics, and other water quality measurements were evaluated using Spearman Rank correlation analysis. Based

on data collected since WY 2003, PCB particle concentrations positively correlate with impervious cover ($r_s = 0.53$), old industrial land use ($r_s = 0.59$), and HgT particle concentrations ($r_s = 0.36$). PCB particle concentrations inversely correlate with watershed area and particle concentrations for arsenic, cadmium, copper, lead, and zinc. HgT particle concentrations do not correlate with those of other trace metals and had similar but weaker relationships to impervious cover, old industrial land use, and watershed area than did PCBs. In contrast, the trace metals arsenic, cadmium, copper, lead, and zinc were all correlated with one another. Overall, the data collected to date do not support the use of any of the trace metals analyzed as a proxy for either PCB or HgT pollution sources.

Old industrial land use is believed to have both the greatest yields as well as total mass of PCB loads in the region. The watersheds for the 83 sites that have been sampled with RMP and grant funding since WY 2003 cover about 26% of the old industrial area in the region. The largest proportion of old industrial area sampled to date in each county has been in Santa Clara County (61% of old industrial area in this county is in the watershed of a sampling site), followed by Alameda (30%), San Mateo (27%), and Contra Costa (9%) counties. Coverage in Santa Clara County is highest because a number of large watersheds have been sampled and old industrial areas are prevalent upstream in two of the watersheds sampled (Coyote Creek and Guadalupe River). Of the remaining areas in the region with old industrial land use yet to be sampled (78 km²), 49% of it lies within 1 km of the Bay and 63% is within 2 km of the Bay. These areas are more likely to be tidal and to include heavy industrial areas that were historically serviced by rail and ship-based transport, and are often very difficult to sample because of a lack of public rights-of-way and tidal-related constraints. It may also be reasonable to suggest that these areas may have relatively high concentrations compared to industrial areas further from the Bay margin due to a longer use period and the nature of heavy machinery associated with rail and ship transport. A different sampling strategy may be needed to effectively estimate what mass of pollution is associated with these areas. In the short term, this Pollutants of Concern Reconnaissance Monitoring study will continue at least into WY 2019 to continue to identify areas for follow-up investigation and possible management action. The focus will continue to be on finding new areas of concern, although follow-up sampling will occur at some sites to verify initial sampling results.

Table of Contents

Executive Summary.....	ii
1. Introduction	1
2. Methods.....	2
2.1 Sampling locations	2
2.2 Field methods.....	15
Mobilization and preparing to sample.....	15
Manual time-paced composite stormwater sampling procedures	15
Remote suspended sediment sampling procedures	15
2.3 Laboratory analytical methods	19
2.4 Interpretive methods.....	20
Estimated particle concentrations.....	20
Derivations of central tendency for comparisons with past data	21
3. Results and Discussion	21
3.1 SSC stormwater concentrations.....	22
3.2 PCBs stormwater concentrations and estimated particle concentrations	22
3.3 Mercury stormwater concentrations and estimated particle concentrations	31
3.4 Trace element (As, Cd, Cu, Mg, Pb, Se and Zn) concentrations.....	35
3.5 Relationships between PCBs and Hg and other trace substances and land-cover attributes	37
3.7 Pros and cons of the remote sampling method.....	47
3.8 Sampling progress in relation to data uses.....	50
4. Summary and Recommendations.....	51
5. References	52
6. Appendices	57
Appendix A: Characteristics of Larger Watersheds	57
Appendix B – Sampling Method Development.....	58
Appendix C – Quality assurance.....	59
Appendix D – Figures 7 and 10 Supplementary Info.....	66

List of Tables

Table 1. Key characteristics of sampling locations.

Table 2. Locations where remote sediment samplers were pilot tested.

Table 3. Laboratory analysis methods.

Table 4. PCB and total mercury water concentrations and estimated particle concentrations measured in the Bay Area based on all RMP data collected in stormwater since water year 2003.

Table 5. Concentrations of selected trace elements measured during winter storms of water years 2015, 2016 and 2017.

Table 10. Spearman rank correlation matrix based on stormwater samples collected in the Bay Area since water year 2003

Table 7a. Remote suspended-sediment sampler PCB data and comparison with manually collected composite water data.

Table 7b. Remote suspended-sediment sampler Hg data and comparison with manually collected composite water data.

Table 8a. Comparison of the advantages and disadvantages of the remote sampling method versus the manual sampling method for the screening of sites.

Table 8b. Labor and cost comparison between the remote sampling method versus the manual composite sampling method for the screening of sites.

List of Figures

Figure 1. Watersheds sampled in to date.

Figure 1a. Watershed boundaries of sites sampled in western Contra Costa County and Solano County.

Figure 1b. Watershed boundaries of sites sampled in eastern Contra Costa County.

Figure 1c. Watershed boundaries of sites sampled in Alameda County.

Figure 1d. Watershed boundaries of sites sampled in northern San Mateo County.

Figure 1e. Watershed boundaries of sites sampled in Santa Clara County.

Figure 2. Sampling equipment used in the field.

Figure 3. PCB estimated particle concentrations for watershed sampling sites measured to date.

Figure 4. Comparison of site rankings for PCBs based on estimated particle concentrations versus water concentrations.

Figure 5. All watershed sampling locations measured to date ranked by total mercury estimated particle concentrations.

Figure 6. Comparison of site rankings for PCB and total mercury (HgT) estimated particle concentrations.

Figure 7. Comparison of site rankings for total mercury (HgT) estimated particle concentrations and water concentrations.

Figure 8. Relationships between observed estimated particle concentrations of PCBs and total mercury (HgT), trace elements, and impervious land cover and old industrial land use.

Figure 9. Results of repeated sampling at 7 sites

Figure 10. Cumulative grain size distribution in the Hamlin suspended-sediment sampler, Walling Tube suspended-sediment sampler, and water composite samples at eight of the sampling locations.

Figure 11. Estimated particle concentration comparisons between remote suspended-sediment samples versus manually collected composite samples, and comparisons of the differences between the methods against their means.

Figure 12. Comparative ratio between remote sampler and manual water composites as a function of the percentage dissolved in the manual water composite for each sampler.

1. Introduction

The San Francisco Bay polychlorinated biphenyl (PCB) and mercury total maximum daily loads (TMDLs) (SFBRWQCB, 2006; 2007) call for implementation of control measures to reduce stormwater polychlorinated biphenyl (PCB) loads from an estimated annual baseline load of 20 kg to 2 kg by 2030 and total mercury (HgT) loads from about 160 kg to 80 kg by 2028. Shortly after adoption of the TMDLs, in 2009 the San Francisco Bay Regional Water Quality Control Board (Regional Water Board) issued the first Municipal Regional Stormwater Permit (MRP) for MS4 phase I stormwater agencies (SFBRWQCB, 2009; 2011). In support of the TMDLs, MRP 1.0, as it came to be known, contained a provision for improved information on stormwater loads for pollutants of concern (POCs) in selected watersheds (Provision C.8.) and specific provisions for Hg, methylmercury and PCBs (Provisions C.11 and C.12) that called for reducing Hg and PCB loads from smaller urbanized tributaries. To help address these permit requirements, a Small Tributaries Loading Strategy (STLS) was developed that outlined four key management questions (MQs) as well as a general plan to address these questions (SFEI, 2009).

MQ1. Which Bay tributaries (including stormwater conveyances) contribute most to Bay impairment from POCs?

MQ2. What are the annual loads or concentrations of POCs from tributaries to the Bay?

MQ3. What are the decadal-scale loading or concentration trends of POCs from small tributaries to the Bay?

MQ4. What are the projected impacts of management actions (including control measures) on tributaries and where should these management actions be implemented to have the greatest beneficial impact?

During the first MRP term (2009-15), the majority of STLS effort was focused on refining pollutant loading estimates and finding and prioritizing potential “high leverage” watersheds and subwatersheds that contribute disproportionately high concentrations or loads to sensitive Bay margins. This work was funded by the RMP and the Bay Area Stormwater Management Agencies Association (BASMAA)¹. Sufficient pollutant data were collected at 11 urban sites to estimate pollutant loads from these sites with varying degrees of certainty (McKee et al., 2015, Gilbreath et al., 2015a). Also during the first MRP term, a Regional Watershed Spreadsheet Model (RWSM) was developed as a regional-scale planning tool, primarily to estimate long-term pollutant loads from the small tributaries, and secondarily to provide supporting information for prioritizing watersheds or sub-watershed areas for management (Wu et al., 2016; 2017).

In November 2015, the Regional Water Board issued the second iteration of the MRP (SFBRWQCB, 2015). MRP “2.0” places an increased focus on finding high-leverage watersheds, source areas, and source properties that are more polluted, and that are located upstream of sensitive Bay margin areas.

¹ BASMAA is made up of a number of programs that represent Permittees and other local agencies

Specifically, the permit adds a stipulation that calls for identification of sources or watershed source areas that provide the greatest opportunities for reductions of PCBs and Hg in urban stormwater runoff. To help support this focus and also to refine information to address Management Questions, the Sources, Pathways, and Loadings Work Group (SPLWG) and the Small Tributaries Loading Strategy Team developed and implemented a stormwater reconnaissance field monitoring protocol in WYs 2015, 2016, 2017 and 2018 to provide data, as part of multiple lines of evidence, for the identification of potential high-leverage areas. The monitoring protocol was adapted from the one first implemented in WY 2011 (McKee et al., 2012) and benefited from lessons learned from that effort. This same field monitoring protocol was also implemented in WYs 2016 - 2018 by the San Mateo Countywide Water Pollution Prevention Program and the Santa Clara Valley Urban Runoff Pollution Prevention Program (EOA, 2017a and 2017b).

This report summarizes and provides a preliminary interpretation of data collected during WYs 2015, 2016, 2017 and 2018. The data collected and presented here contribute to a broad effort of identifying potential management areas for pollutant reduction. During Calendar Year (CY) 2018, the RMP is funding a data analysis project that aims to mine and analyze all existing stormwater PCB data. The primary goals of that analysis are to develop more methods for identifying and ranking watersheds of management interest for further investigation, and to guide future sampling design (McKee et al., in review). In addition, the STLS team is evaluating sampling protocols for monitoring stormwater loading trends in response to management efforts (Melwani et al., 2018) and has developed a trends strategy that outlines key elements including modeling needs (Wu, et. al., 2018). Reconnaissance data collected in WYs 2011, 2015, 2016, 2017 and 2018 may provide “baseline” data for identifying concentration or particle concentration trends over time, with the understanding that management actions to control PCB and Hg loads are increasingly being implemented throughout this period.

The report is designed to be updated annually and will be updated again in approximately 12 months to include WY 2019 sampling data currently being collected.

2. Methods

2.1 Sampling locations

Four objectives were used as a basis for site selection.

1. Identifying potential high-leverage watersheds and subwatersheds
 - a. Watersheds with suspected high pollution
 - b. Sites with ongoing or planned management actions
 - c. Source identification within a larger watershed of known concern (nested sampling design)
2. Sampling strategic large watersheds with USGS gauges to provide first-order loading estimates and to support calibration of the Regional Watershed Spreadsheet Model (RWSM)
3. Validating unexpected low (potential false negative) concentrations (to address the possibility of a single storm composite poorly characterizing a sampling location)

WYs 2015 through 2018 POC Reconnaissance Monitoring

4. Filling gaps along environmental gradients or source areas (to allow for the continuing reevaluation of our conceptual understanding of relationships between land uses, source areas and pollutant concentrations and loads)

The majority of samples during WYs 2015-2017 (60-80% of the effort) were dedicated to identifying potential high-leverage watersheds and subwatersheds. The remaining resources were allocated to addressing the other three objectives. In WY 2018, 50% of the resources were allocated to identifying potential high-leverage watersheds while the other 50% was allocated to resampling watersheds previously measured in reconnaissance sampling in order to validate concentrations previously measured. RMP SPLWG staff worked with the respective Countywide Programs to identify priority drainages for monitoring including storm drains, ditches/culverts, tidally influenced areas, and natural areas. During the summers of 2014, 2015, 2016 and 2017, approximately 100 sites were visited, and each was surveyed for safety, logistical constraints, and feasible drainage-line entry points. From this larger set, a final set of about 15-25 sites was selected each year to form the pool from which field staff would select sampling locations for each storm depending on logistics.

Watershed sites with a wide variety of characteristics were sampled in WYs 2015, 2016, 2017 and 2018 (Figure 1 and Table 1). Of these sites, 19 were in Santa Clara County, 19 in San Mateo County, 17 in Alameda County, 9 in Contra Costa County² and 1 site in Solano County. The drainage area for each sampling location ranged from 0.02 to 233 km² and imperviousness based on the National Land Cover Database (Homer et al., 2015) ranged from 2%-88%. Typically, however, the reconnaissance watersheds were characterized as small (75% were smaller than 5.2 sq km) with a high degree of imperviousness (75% of watersheds were greater than 60% impervious). The percentage of the watersheds designated as old industrial³ ranged from 0 to 87% (mean 24%) (dataset used included the land use dataset input to the Regional Watershed Spreadsheet Model (<https://www.sfei.org/projects/regional-watershed-spreadsheet-model#sthash.bUGyXA2x.dpbs>)). Although most of the sampling sites were selected primarily to identify potential high-leverage watersheds and subwatersheds, Lower Penitencia Creek was resampled in WY 2015 to verify whether the first sample collected there (WY 2011) was a false negative (unexpectedly low concentration). Guadalupe River at Hwy 101 was also resampled for PCBs in WY 2017 as a piggyback opportunity during a large and rare storm sampled primarily to assess trends for mercury (McKee et al., 2018). And in WY 2018, five sites (including: Gull Dr. Outfall, Gull Dr. Stormdrain, Kirker Ck at Pittsburgh Antioch Hwy, Meeker Slough and the Outfall at Gilman St.) were resampled to verify stormwater concentrations previously measured. A matrix of site characteristics for sampling strategic larger watersheds was also developed (Appendix A), but no larger watersheds were sampled in WYs 2015 or 2016 because the sampling trigger criteria for rainfall and flow were not met, and only one (Colma Creek) was sampled in WY 2017. Trigger criteria were met in January and February 2017 for other strategic larger watersheds under consideration (Alameda Creek at EBRPD Bridge at Quarry Lakes,

² Given the long history of industrial zoning along much of the Contra Costa County waterfront relative to other counties, more sampling is needed to characterize these areas.

³ Note that the definition of “old Industrial” land use used here is based on definitions developed by the Santa Clara Valley Urban Runoff Pollution Prevention Program (SCVURPPP) building on GIS development work completed during the development of the RWSM (Wu et al., 2016; 2017).

WYs 2015 through 2018 POC Reconnaissance Monitoring

Dry Creek at Arizona Street, San Francisquito Creek at University Avenue, Matadero Creek at Waverly Street, and Colma Creek at West Orange Avenue), but none were sampled because staff and budgetary resources were allocated elsewhere. The completed reconnaissance monitoring complemented more in-depth sampling campaigns (2-8 years of sampling at each site) designated as the “Loadings Study” sites in Figure 1.

DRAFT

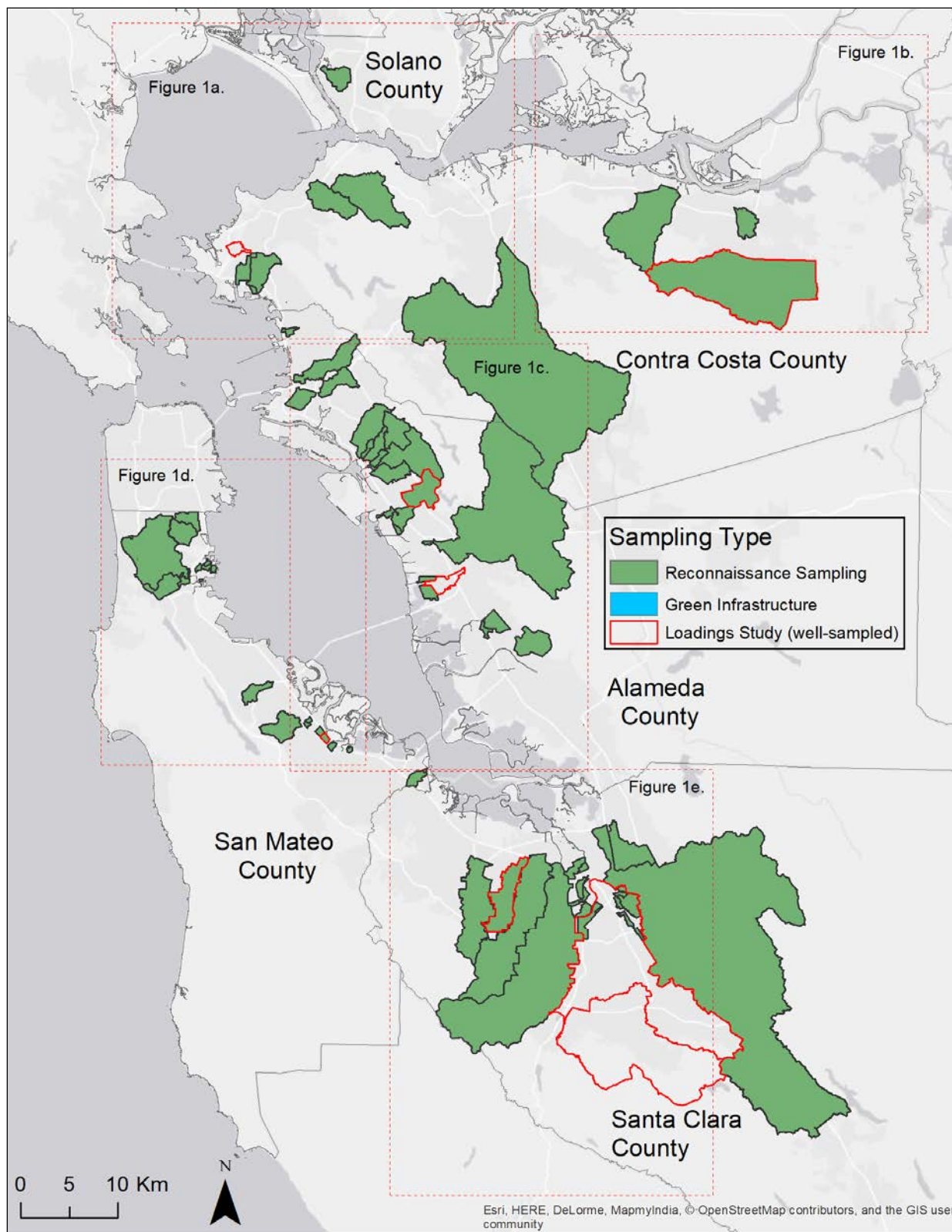

Figure 1. Watersheds sampled to date. Note: Green Infrastructure sampling sites are so small they are not visible, though they are given a numeric map key identifier.

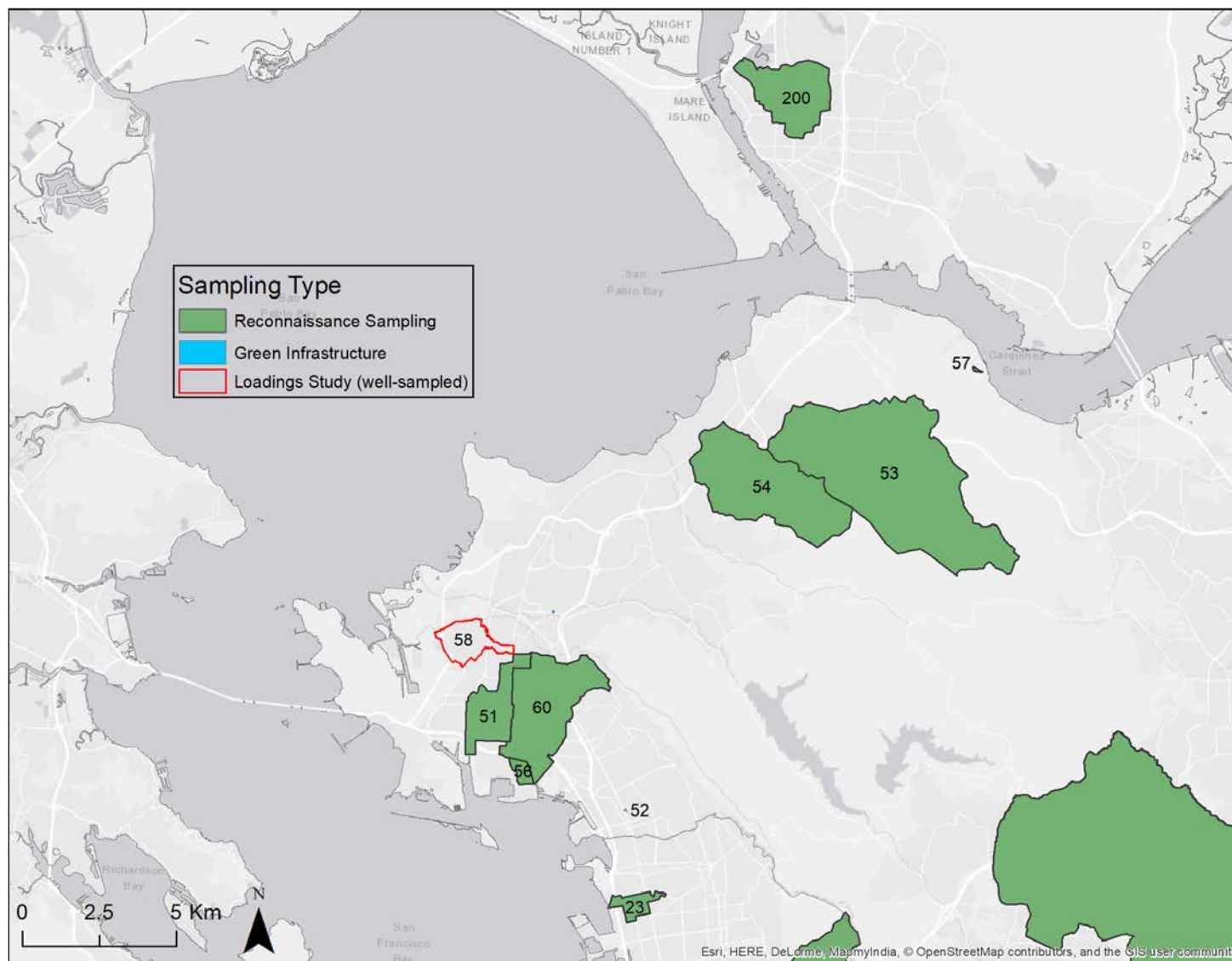

Figure 1a. Watershed boundaries of sites sampled in western Contra Costa County and Solano County. Note: Green Infrastructure sampling sites are so small they are not visible, though they are given a numeric map key identifier.

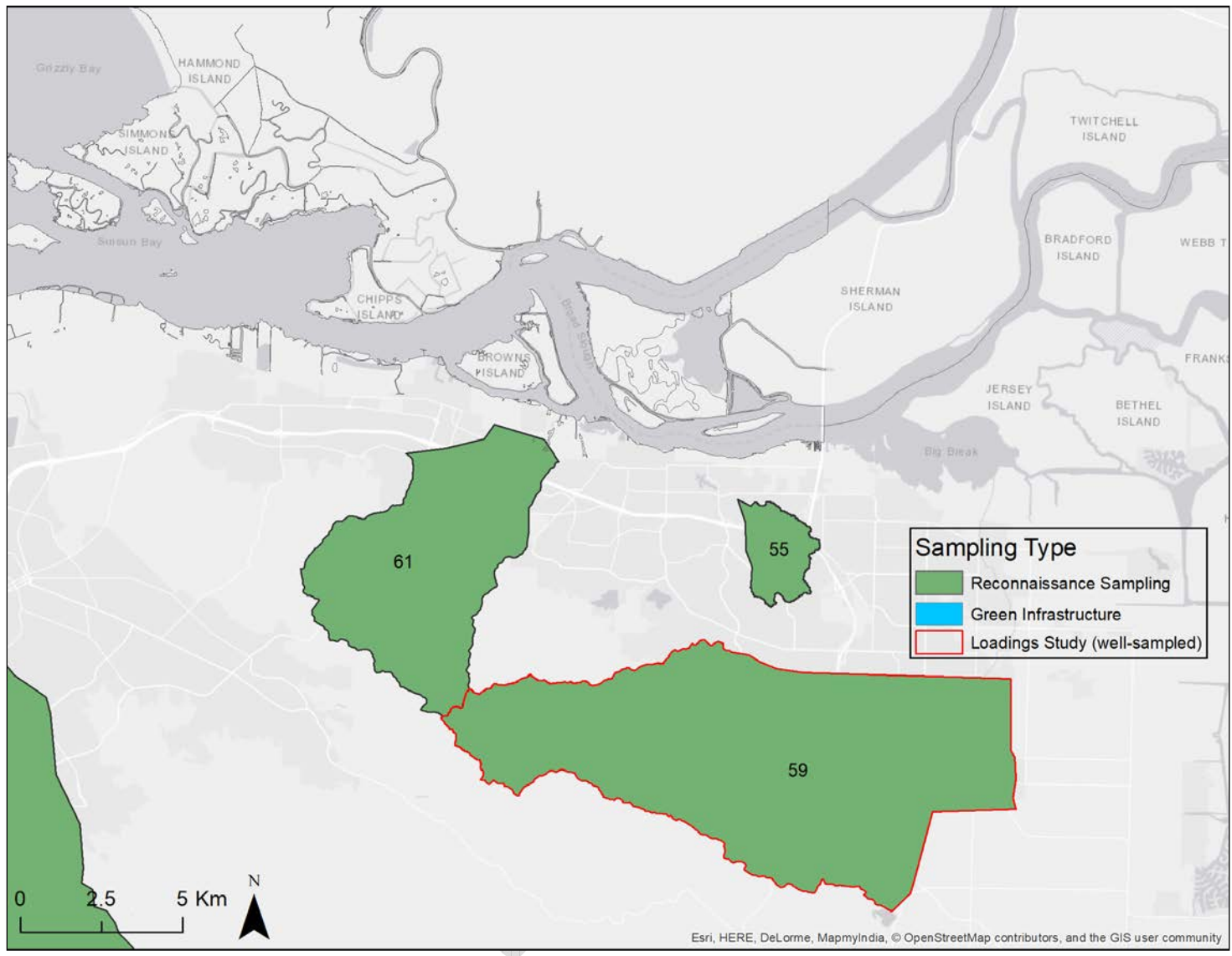

Figure 1b. Watershed boundaries of sites sampled in eastern Contra Costa County. Note: Green Infrastructure sampling sites are so small they are not visible, though they are given a numeric map key identifier.

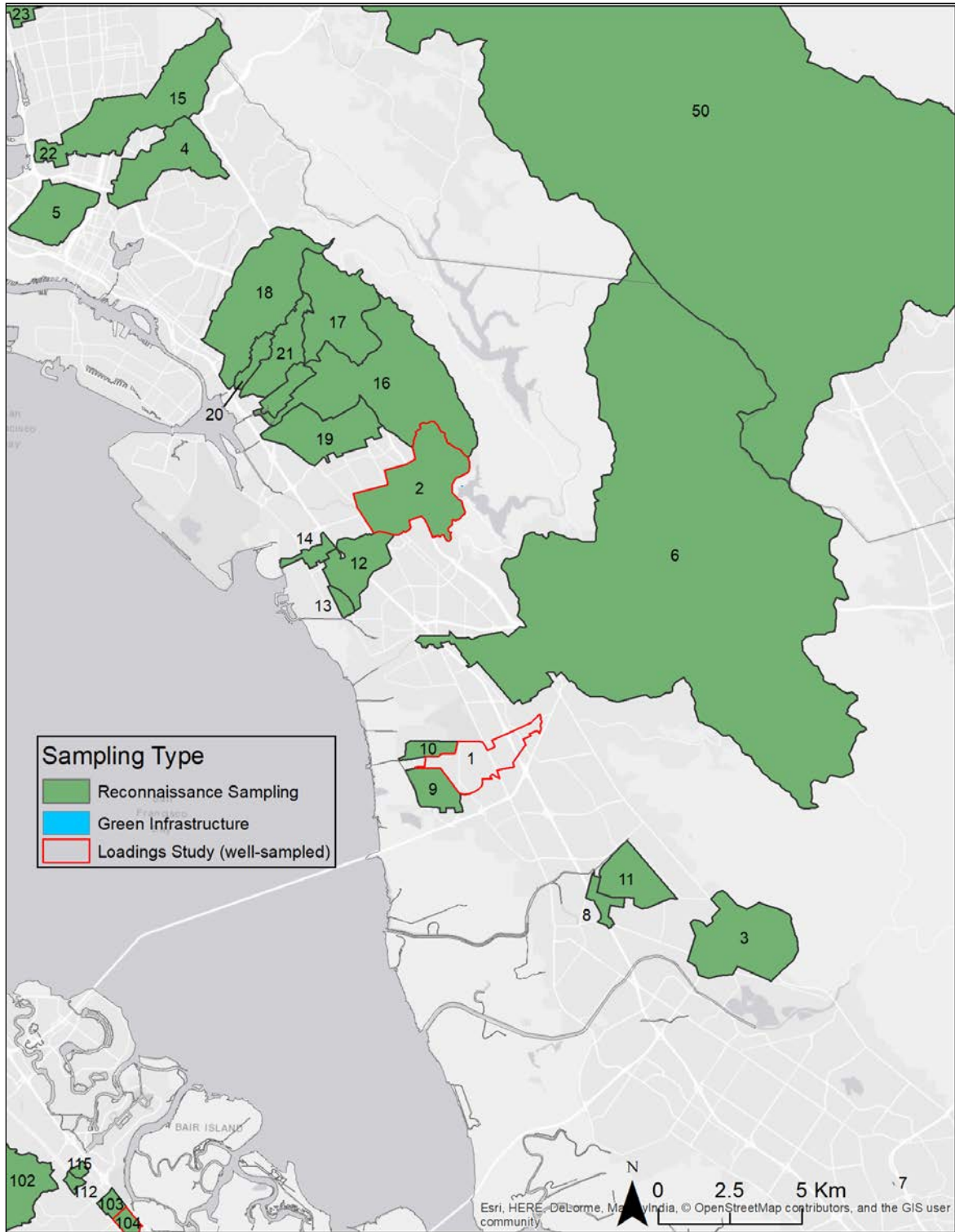

Figure 1c. Watershed boundaries of sites sampled in Alameda County. Note: Green Infrastructure sampling sites are so small they are not visible, though they are given a numeric map key identifier.

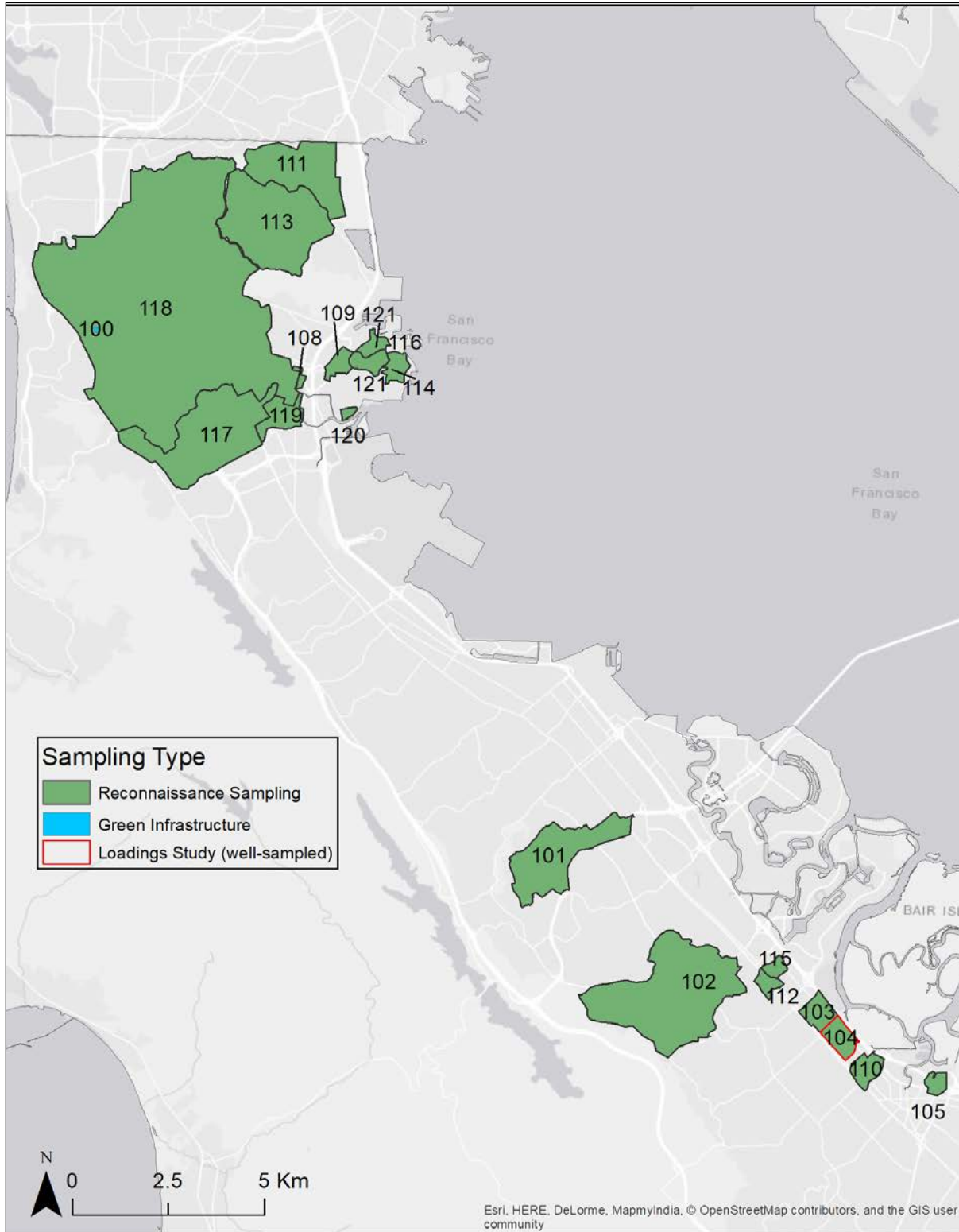

Figure 1d. Watershed boundaries of sites sampled in northern San Mateo County. Note: Green Infrastructure sampling sites are so small they are not visible, though they are given a numeric map key identifier.

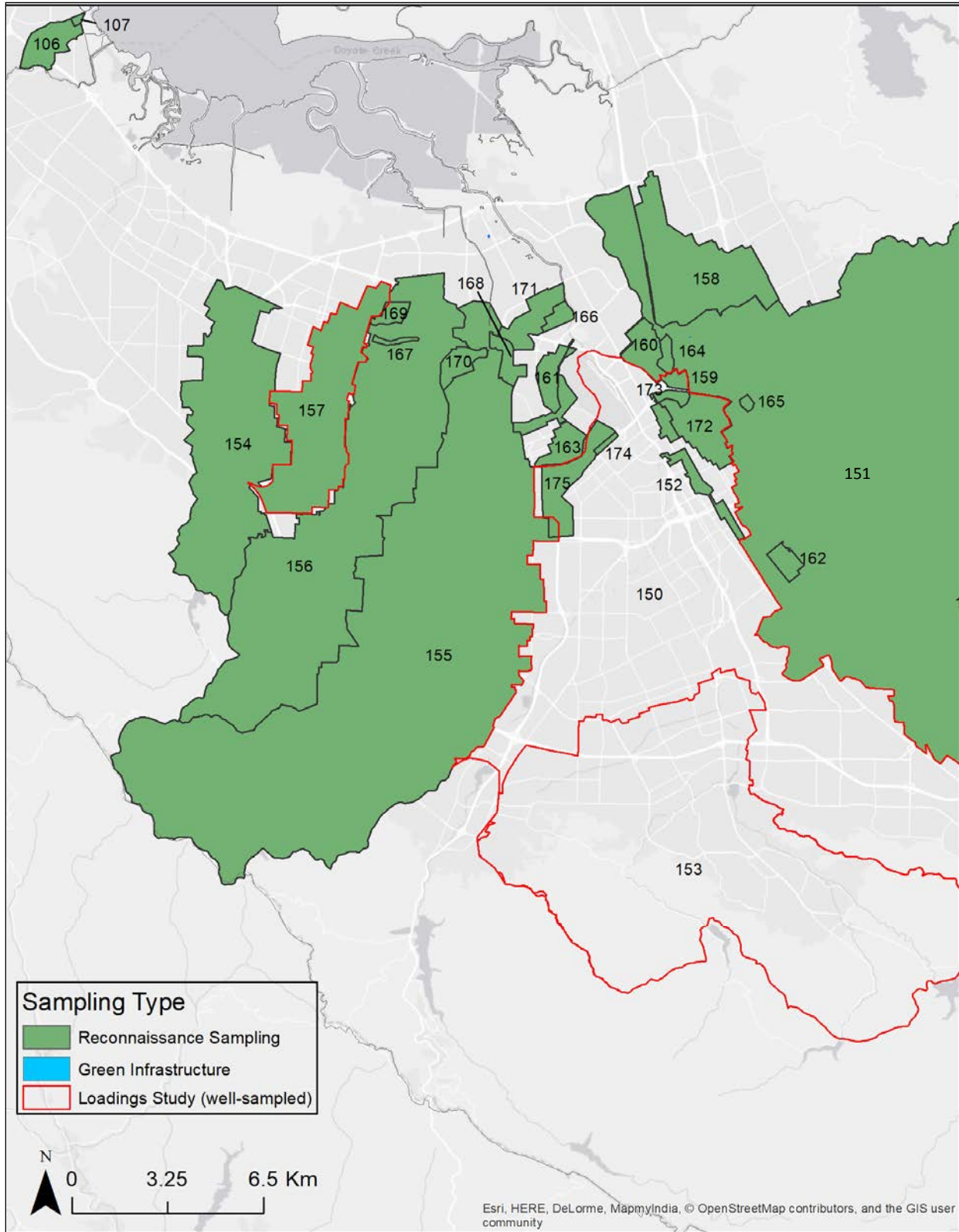

Figure 1e. Watershed boundaries of sites sampled in Santa Clara County. Note: Green Infrastructure sampling sites are so small they are not visible, though they are given a numeric map key identifier.

WYs 2015 through 2018 POC Reconnaissance Monitoring

Table 1. Key characteristics of the 83 sampling locations. Note gaps in continuous numbering allow for the addition of locations in the future so that the unique identifying numbers for each county remain in the same 50-count.

Map Key	County	City	Watershed Name	Catchment Code	MS4 or Receiving Water	Latitude	Longitude	Sample Date	Area (sq km)	Impervious Cover (%)	Old Industrial (%)
1	Alameda	Hayward	Zone 4 Line A	Z4LA	MS4	37.645328	-122.137364	WY 2007-2010	4.2	68%	12%
2	Alameda	San Leandro	San Leandro Creek	SLC	MS4	37.726119	-122.162696	12/5/10 & 12/19/10; WYs 2012-14	8.9	38%	0%
3	Alameda	Union City	Zone 5 Line M	Z5LM	MS4	37.586476	-122.028427	12/17/10 & 3/19/11	8.1	34%	5%
4	Alameda	Oakland	Glen Echo Creek	Glen Echo Creek	MS4	37.818271	-122.260326	2/15/11	5.5	39%	0%
5	Alameda	Oakland	Ettie Street Pump Station	ESPS	MS4	37.826043	-122.288942	2/17/11	4.0	75%	22%
6	Alameda	San Leandro	San Lorenzo Creek	San Lorenzo Creek	MS4	37.684836	-122.138599	12/17/10 & 12/19/10	125	13%	0%
7	Alameda	Fremont	Fremont Osgood Road Bioretention Influent	Fremont Osgood Road Bioretention Influent	Bioretention Influent	37.518394	-121.945225	2012, 2013	0.00	76%	0%
8	Alameda	Union City	Line 3A-M at 3A-D	AC-Line 3A-M	MS4	37.61285	-122.06629	12/11/14	0.88	73%	12%
9	Alameda	Hayward	Line 4-E	AC-Line 4-E	MS4	37.64415	-122.14127	12/16/14	2.00	81%	27%
10	Alameda	Hayward	Line 4-B-1	AC-Line 4-B-1	MS4	37.64752	-122.14362	12/16/14	0.96	85%	28%
11	Alameda	Union City	Line 3A-M-1 at Industrial PS	AC-Line 3A-M-1	MS4	37.61893	-122.05949	12/11/14	3.44	78%	26%
12	Alameda	San Leandro	Line 9-D	AC-Line 9-D	MS4	37.69383	-122.16248	4/7/15	3.59	78%	46%
13	Alameda	San Leandro	Line 9-D-1 PS at outfall to Line 9-D	AC-2016-15	MS4	37.69168	-122.16679	1/5/16	0.48	88%	62%
14	Alameda	San Leandro	Line 13-A at end of slough	AC-2016-14	MS4	37.70497	-122.19137	3/10/16	0.83	84%	68%
15	Alameda	Emeryville	Zone 12 Line A under Temescal Ck Park	AC-2016-3	MS4	37.83450	-122.29159	1/6/16	9.41	42%	0.6%
16	Alameda	Oakland	Line 12K at Coliseum Entrance	Line12KEntrance	MS4	37.75446	-122.20431	2/9/17	16.40	31%	1%
17	Alameda	Oakland	Line 12J at mouth to 12K	Line12J	MS4	37.75474	-122.20136	12/15/16	8.81	30%	2%
18	Alameda	Oakland	Line 12F below PG&E station	Line12F	MS4	37.76218	-122.21431	12/15/16	10.18	56%	3%
19	Alameda	Oakland	Line 12M at Coliseum Way	Line12MColWay	MS4	37.74689	-122.20069	2/9/17	5.30	69%	22%
20	Alameda	Oakland	Line 12H at Coliseum Way	Line12H	MS4	37.76238	-122.21217	12/15/16	0.97	71%	10%
21	Alameda	Oakland	Line 12I at Coliseum Way	Line12I	MS4	37.75998	-122.21020	12/15/16	3.41	63%	9%

WYs 2015 through 2018 POC Reconnaissance Monitoring

Map Key	County	City	Watershed Name	Catchment Code	MS4 or Receiving Water	Latitude	Longitude	Sample Date	Area (sq km)	Impervious Cover (%)	Old Industrial (%)
22	Alameda	Emeryville	Zone 12 Line A at Shellmound	Line12AShell	MS4	37.83424	-122.29352	1/8/18	10.48	41%	6%
23	Alameda	Berkeley	Outfall at Gilman St.	AC-2016-1	MS4	37.87761	-122.30984	12/21/15 & 1/9/18	0.84	76%	32%
50	Contra Costa	Concord	Walnut Creek	Walnut Creek	Receiving Water	37.96962	-122.053778	12/28/10	232	15%	0%
51	Contra Costa	Richmond	Santa Fe Channel	Santa Fe Channel	MS4	37.92118056	-122.3619972	12/05/10	3.3	69%	3%
52	Contra Costa	El Cerrito	El Cerrito Bioretention Influent	ELC	Bioretention Influent	37.905884	-122.304929	WY 2012, 2014-15, 2017	0.00	74%	0%
53	Contra Costa	Rodeo	Rodeo Creek at Seaclyff Ct. Pedestrian Br.	RodeoCk	Receiving Water	38.01604	-122.25381	1/18/17	23.41	2%	3%
54	Contra Costa	Hercules	Refugio Ck at Tsushima St	RefugioCk	Receiving Water	38.01775	-122.27710	1/18/17	10.73	23%	0%
55	Contra Costa	Antioch	East Antioch nr Trembath	EAntioch	Receiving Water	38.00333	-121.78106	1/8/17	5.26	26%	3%
56	Contra Costa	Richmond	MeekerWest	MeekerWest	Receiving Water	37.91313	-122.33871	1/9/18	0.41	70%	69%
57	Contra Costa	Port Costa	Little Bull Valley	Little Bull Valley	Receiving Water	38.03680	-122.17662	3/1/18	0.02	67%	2%
58	Contra Costa	Richmond	North Richmond Pump Station	NRPS	MS4	37.953903	-122.373997	WY 2011, 2013-14	2.0	62%	18%
59	Contra Costa	Oakley	Lower Marsh Creek	LMC	Receiving Water	37.990723	-121.696118	3/24/11; WYs 2012-14	84	10%	0%
60	Contra Costa	Richmond	Meeker Slough	Meeker Slough	Receiving Water	37.91786	-122.33838	12/3/14 & 1/9/18	7.34	64%	6%
61	Contra Costa	Pittsburg	Kirker Ck at Pittsburg Antioch Hwy and Verne Roberts Cir	KirkerCk	Receiving Water	38.01275	-121.84345	1/8/17 & 4/6/18	36.67	18%	5%
100	San Mateo	Daly City	Gellert Park Daly City Library Bioretention Influent	Gellert Park	Bioretention Influent	37.663037	-122.470585	WY 2009	0.02	40%	0%
101	San Mateo	San Mateo	Borel Creek	Borel Creek	MS4	37.551273	-122.309424	3/18/11	3.2	31%	0%
102	San Mateo	Belmont	Belmont Creek	Belmont Creek	MS4	37.517328	-122.276109	3/18/11	7.2	27%	0%
103	San Mateo	San Carlos	Pulgas Pump Station-North	Pulgas Pump Station-North	MS4	37.5045833	-122.2490056	2/17/11 & 3/18/11	0.55	84%	52%
104	San Mateo	San Carlos	Pulgas Pump Station-South	Pulgas Pump Station-South	MS4	37.5045833	-122.2490056	2/17/11 & 3/18/11; WYs 2013-14	0.58	87%	54%
105	San Mateo	Redwood City	Oddstad PS	SM-267	MS4	37.49172	-122.21886	12/2/14	0.28	74%	11%
106	San Mateo	East Palo Alto	Runnymede Ditch	SM-70	MS4	37.46883	-122.12701	2/6/15	2.05	53%	2%
107	San Mateo	East Palo Alto	SD near Cooley Landing	SM-72	MS4	37.47492	-122.12640	2/6/15	0.11	73%	39%

WYs 2015 through 2018 POC Reconnaissance Monitoring

Map Key	County	City	Watershed Name	Catchment Code	MS4 or Receiving Water	Latitude	Longitude	Sample Date	Area (sq km)	Impervious Cover (%)	Old Industrial (%)
108	San Mateo	South San Francisco	South Linden PS	SM-306	MS4	37.65018	-122.41127	2/6/15	0.14	83%	22%
109	San Mateo	South San Francisco	Gateway Ave SD	SM-293	MS4	37.65244	-122.40257	2/6/15	0.36	69%	52%
110	San Mateo	Redwood City	Veterans PS	SM-337	MS4	37.49723	-122.23693	12/15/14	0.52	67%	7%
111	San Mateo	Brisbane	Tunnel Ave Ditch	SM-350/368/more	Receiving Water	37.69490	-122.39946	3/5/16	3.02	47%	8%
112	San Mateo	San Carlos	Taylor Way SD	SM-32	MS4	37.51320	-122.26466	3/11/16	0.27	67%	11%
113	San Mateo	Brisbane	Valley Dr SD	SM-17	MS4	37.68694	-122.40215	3/5/16	5.22	21%	7%
114	San Mateo	South San Francisco	Forbes Blvd Outfall	SM-319	MS4	37.65889	-122.37996	3/5/16	0.40	79%	0%
115	San Mateo	San Carlos	Industrial Rd Ditch	SM-75	MS4	37.51831	-122.26371	3/11/16	0.23	85%	79%
116	San Mateo	South San Francisco	Gull Dr SD	SM-314	MS4	37.66033	-122.38510	3/5/16 & 1/9/18	0.30	78%	54%
117	San Mateo	South San Francisco	S Spruce Ave SD at Mayfair Ave (296)	SSpruce	MS4	37.65084	-122.41811	1/8/17	5.15	39%	1%
118	San Mateo	South San Francisco	Colma Ck at S. Linden Blvd	ColmaCk	MS4	37.65017	-122.41189	2/7/17	35.07	41%	3%
119	San Mateo	South San Francisco	S Linden Ave SD (291)	SLinden	MS4	37.64420	-122.41390	1/8/17	0.78	88%	57%
120	San Mateo	South San Francisco	Outfall to Colma Ck on service rd nr Littlefield Ave. (359)	ColmaCkOut	MS4	37.64290	-122.39677	2/7/17	0.09	88%	87%
121	San Mateo	South San Francisco	Gull Dr Outfall	SM-315	MS4	37.66033	-122.38502	3/5/16 & 1/9/18	0.43	75%	42%
150	Santa Clara	San Jose	Guadalupe River at Hwy 101	Guad 101	Receiving Water	37.37355	-121.93269	WYs 2003-2006, 2010, 2012-2014; 1/8/17	233.00	39%	3%
151	Santa Clara	Milpitas	Lower Coyote Creek	Lower Coyote Creek	Receiving Water	37.421814	-121.928153	2005	327	22%	1%
152	Santa Clara	San Jose	San Pedro Storm Drain	San Pedro Storm Drain	MS4	37.343769	-121.900781	2006	1.3	72%	16%
153	Santa Clara	San Jose	Guadalupe River at Foxworthy Road/ Almaden Expressway	GRFOX	Receiving Water	37.278396	-121.877944	2010	107	22%	0%
154	Santa Clara	Mountain View	Stevens Creek	Stevens Creek	Receiving Water	37.391306	-122.069586	2/18/11	26	38%	1%
155	Santa Clara	Santa Clara	San Tomas Creek	San Tomas Creek	Receiving Water	37.388992	-121.968634	12/28/10	108	33%	0%

WYs 2015 through 2018 POC Reconnaissance Monitoring

Map Key	County	City	Watershed Name	Catchment Code	MS4 or Receiving Water	Latitude	Longitude	Sample Date	Area (sq km)	Impervious Cover (%)	Old Industrial (%)
156	Santa Clara	Santa Clara	Calabazas Creek	Calabazas Creek	Receiving Water	37.4034556	-121.9867056	12/28/10	50	44%	3%
157	Santa Clara	Sunnyvale	Sunnyvale East Channel	SunCh	Receiving Water	37.394728	-122.010441	3/19/11; WYs 2012-14	15	59%	4%
158	Santa Clara	Milpitas	Lower Penitencia Ck	Lower Penitencia	Receiving Water	37.42985	-121.90913	WY 2011; 12/11/14	11.50	65%	2%
159	Santa Clara	San Jose	E. Gish Rd SD	SC-066GAC550	MS4	37.36632	-121.90203	12/11/14	0.44	84%	71%
160	Santa Clara	San Jose	Charcot Ave SD	SC-051CTC275	MS4	37.38413	-121.91076	4/7/15	1.79	79%	25%
161	Santa Clara	Santa Clara	Seaboard Ave SD SC-050GAC580	SC-050GAC580	MS4	37.37637	-121.93793	12/11/14	1.35	81%	68%
162	Santa Clara	San Jose	Rock Springs Dr SD	SC-084CTC625	MS4	37.31751	-121.85459	2/6/15	0.83	80%	10%
163	Santa Clara	Santa Clara	Seaboard Ave SD SC-050GAC600	SC-050GAC600	MS4	37.37636	-121.93767	12/11/14	2.80	62%	18%
164	Santa Clara	San Jose	Ridder Park Dr SD	SC-051CTC400	MS4	37.37784	-121.90302	12/15/14	0.50	72%	57%
165	Santa Clara	San Jose	Outfall to Lower Silver Ck	SC-067SCL080	MS4	37.35789	-121.86741	2/6/15	0.17	79%	78%
166	Santa Clara	Santa Clara	Victor Nelo PS Outfall	SC-050GAC190	MS4	37.38991	-121.93952	1/19/16	0.58	87%	4%
167	Santa Clara	Santa Clara	Lawrence & Central Expwys SD	SC-049CZC800	MS4	37.37742	-121.99566	1/6/16	1.20	66%	1%
168	Santa Clara	Santa Clara	E Outfall to San Tomas at Scott Blvd	SC-049STA550	MS4	37.37991	-121.96842	3/6/16	0.67	66%	31%
169	Santa Clara	Santa Clara	Duane Ct and Ave Triangle SD	SC-049CZC200	MS4	37.38852	-121.99901	12/13/15 & 1/6/2016	1.00	79%	23%
170	Santa Clara	Santa Clara	Condensa St SD	SC-049STA710	MS4	37.37426	-121.96918	1/19/16	0.24	70%	32%
171	Santa Clara	Santa Clara	Haig St SD	SC-050GAC030	MS4	37.38664	-121.95223	3/6/16	2.12	72%	10%
172	Santa Clara	San Jose	Rosemary St SD 066GAC550C	Rosemary	MS4	37.36118	-121.90594	1/8/17	3.67	64%	11%
173	Santa Clara	San Jose	North Fourth St SD 066GAC550B	NFourth	MS4	37.36196	-121.90535	1/8/17	1.01	68%	27%
174	Santa Clara	San Jose	GR outfall 066GAC900	GR outfall 066GAC900	MS4	37.35392	-121.91223	4/7/18	0.17	66%	1%
175	Santa Clara	San Jose	GR outfall 066GAC850	GR outfall 066GAC850	MS4	37.35469	-121.91279	4/7/18	3.35	61%	6%
200	Solano	Vallejo	Austin Ck at Hwy 37	AustinCk	Receiving Water	38.12670	-122.26791	3/24/17	4.88	61%	2%

2.2 Field methods

Mobilization and preparing to sample

The mobilization for sampling was typically triggered by storm forecast. When a minimum rainfall of at least one-quarter inch⁴ over 6 hours was forecast, sampling teams were deployed, ideally reaching the sampling site about 1 hour before the onset of rainfall⁵. When possible, one team sampled two sites close to one another to increase efficiency and reduce staffing costs. Upon arrival, the team assembled equipment and carried out final safety checks. Sampling equipment used at a site depended on the accessibility of drainage lines. Some sites were sampled by attaching laboratory-prepared trace-metal-clean Teflon sampling tubing to a painter's pole and a peristaltic pump with laboratory-cleaned silicone pump-roller tubing (Figure 2a). During sampling, the tube was dipped into the channel or drainage line at mid-channel mid-depth (if shallow) or depth integrating if the depth was more than 0.5 m. In other cases, a DH 84 (Teflon) sampler was used without a pump.

Manual time-paced composite stormwater sampling procedures

At each site, a time-paced composite sample was collected with a variable number of sub-samples, or aliquots. Based on the weather forecast, prevailing on-site conditions, and radar imagery, field staff estimated the duration of the storm and selected an aliquot size for each analyte (0.1-0.5 L) and number of aliquots (minimum=2; mode=5) to ensure the minimum volume requirements for each analyte (Hg, 0.25L; SSC, 0.3L; PCBs, 1L; Grain Size, 1L; TOC, 0.25L) were reached before the storm's end. Because the minimum volume requirements were less than the size of the sample bottles, there was flexibility to add aliquots in the event when a storm continued longer than predicted. The final volume of the aliquots was determined just before the first aliquot was taken and remained fixed for the sampling event. All aliquots for a storm were collected into the same bottle, which was kept in a cooler on ice and/or refrigerated at 4 °C before transport to a laboratory (see Yee et al. (2017)) for information about bottles, preservatives and holding times).

Remote suspended sediment sampling procedures

Two remote samplers, the Hamlin (Lubliner, 2012) and the Walling Tube (Phillips et al., 2000), were deployed at approximately mid-channel/storm drain to collect suspended sediment samples. To date, ten locations have been sampled with the Hamlin sampler and nine locations with the Walling Tube sampler (Table 2). Due to both samplers being trialed at five sites, a total of 14 sites of differing characteristics have now been sampled. During deployment, the Hamlin sampler⁶ was stabilized on the bed of the storm drain or concrete channel either by its own weight (approximately 25 lbs) or by attaching barbell weight plates to the bottom of the sampler (Figure 2b). The Walling Tube could not be deployed in storm drains because of its size and the requirement that it be horizontal, and therefore

⁴ Note, this was relaxed in some years due to a lack of larger storms. Ideally, mobilization would only proceed with a minimum forecast of at least 0.5".

⁵ Antecedent dry-weather was not considered prior to deployment. Antecedent conditions can have impacts on the concentration of certain build-up/wash-off pollutants like metals. For PCBs, however, antecedent dry-weather may be less important than the mobilization of in-situ legacy sources.

⁶ In future years, if the Hamlin is deployed within a natural bed channel, elevating the sampler a greater distance from the bed may be considered but was not done in WYs 2015-2018.

Walling Tube samplers were only used in open channels and secured either by barbell weights attached by hose clamps to a concrete bed, or to a natural bed with hose clamps attached to temporarily installed rebar (Figure 2c). To minimize the chances of sampler loss, both samplers were secured by a stainless steel cable to a temporary rebar anchor or another object such as a tree or fencepost.

The remote samplers were deployed for the duration of the manual sampling and removed from the channel bed/storm drain bottom shortly after the last water-quality-sample aliquot was collected. Water and sediment collected in the samplers were decanted into one or two large glass bottles. When additional water was needed to flush the settled sediment from the remote samplers into the collecting bottles, site water from the sampled channel was used. The collected samples were split and placed into laboratory containers and shipped to the laboratory for analysis. Most samples were analyzed as whole-water samples (because of insufficient solid mass to analyze as a sediment sample); a sample from only one location was analyzed as a sediment sample. Between sampling sites, the remote samplers were thoroughly cleaned using a brush and Alconox detergent, followed by a dionized water (DI) rinse.

DRAFT

(a)



(b)



(c)



(d)



Figure 2. Sampling equipment used in the field. (a) Painter's pole, Teflon tubing, and an ISCO used as a slave pump; (b) Teflon bottle attached to the end of a DH81 sampling pole; (c) a Hamlin suspended sediment sampler secured atop a 45-lb plate; and (d) a Walling Tube suspended sediment sampler secured by 5-lb weights along the body of the tube (because it is sitting atop a concrete bed) and rebar driven into the natural bed at the back of the sampler.

Table 2. Locations where remote sediment samplers were pilot tested.

Site	Date	Sampler(s) deployed	Comments
Meeker Slough	11/2015	Hamlin and Walling Tube	Sampling effort was unsuccessful because of very high velocities. Both samplers washed downstream because they were not weighted down enough and debris caught on the securing lines.
Outfall to Lower Silver Creek	2/06/15	Hamlin and Walling Tube	Sampling effort was successful. This sample was analyzed as a water sample.
Charcot Ave Storm Drain	4/07/15	Hamlin	Sampling effort was successful. This sample was analyzed as a sediment sample.
Cooley Landing Storm Drain	2/06/15	Hamlin	Sampling effort was successful. This sample was analyzed as a water sample.
Duane Ct and Ave Triangle SD	1/6/2016	Hamlin	Sampling effort was successful. This sample was analyzed as a water sample.
Victor Nelo PS Outfall	1/19/2016	Hamlin and Walling Tube	Sampling effort was successful. This sample was analyzed as a water sample.
Forbes Blvd Outfall	3/5/2016	Hamlin	Sampling effort was successful. This sample was analyzed as a water sample.
Tunnel Ave Ditch	3/5/2016	Hamlin and Walling Tuber	Sampling effort was successful. This sample was analyzed as a water sample.
Taylor Way SD	3/11/2016	Hamlin	Sampling effort was successful. This sample was analyzed as a water sample.
Colma Creek Outfall	2/7/2017	Walling Tube	Sampling effort was successful; however, sampler became submerged for several hours during a high tide cycle and was retrieved afterwards. We hypothesize that this may have had the effect of adding cleaner sediment into the sampler and therefore the result may be biased low. This sample was analyzed as a water sample.
Austin Creek	3/24/2017	Hamlin and Walling Tube	Sampling effort was successful. This sample was analyzed as a water sample.
Refugio Creek	1/18/2017	Walling Tube	Sampling effort was successful. This sample was analyzed as a water sample.
Rodeo Creek	1/18/2017	Walling Tube	Sampling effort was successful. This sample was analyzed as a water sample.
Outfall at Gilman St.	1/9/2018	Hamlin and Walling Tube	Sampling effort was successful; however, Hamlin sampler could not be gently lowered into place on the bed and instead was dropped from approximately 1.5 ft above the bed; it is possible, therefore, that the sampler did not lay horizontal along the bed. This sample was analyzed as a water sample.
Meeker West	1/9/2018	Walling Tube	Sampling effort was successful. This sample was analyzed as a water sample.

2.3 Laboratory analytical methods

The target analytes for this study are listed in Table 3. The analytical methods and quality control tests are further described in the RMP Quality Assurance Program Plan (Yee et al., 2017). Laboratory methods were chosen based on a combination of factors, including method detection limits, accuracy and precision, and costs (BASMAA, 2011; 2012) (Table 3). For some sites where remote samplers were deployed, both particulate and dissolved phases of Hg, PCBs and organic carbon (OC) were analyzed for comparison with whole-water concentrations and particulate-only concentrations from manually collected water samples.

Table 3. Laboratory analysis methods.

Analysis	Matrix	Analytical Method	Lab	Filtered	Field Preservation	Contract Lab / Preservation Hold Time
PCBs (40) ⁷ -Total	Water	EPA 1668	AXYS	No	NA	NA
PCBs (40) ⁷ -Dissolved	Water	EPA 1668	AXYS	Yes	NA	NA
PCBs (40) ⁷	Sediment	EPA 1668	AXYS	NA	NA	NA
Mercury-Total	Water	EPA 1631E	BRL	No	BrCl	BRL preservation with BrCl within 28 days
Mercury-Dissolved	Water	EPA 1631E	BRL	Yes	BrCl	BRL preservation with BrCl within 28 days
Mercury	Sediment	EPA 1631E, Appendix	BRL	NA	NA	7 days
Metals-Total (As, Cd, Pb, Cu, Zn)	Water	EPA 1638 mod	BRL	No	HNO ₃	BRL preservation with Nitric acid within 14 days
SSC	Water	ASTM D3977	USGS	No	NA	NA
Grain size	Water	USGS GS method	USGS	No	NA	NA
Organic carbon-Total (WY 2015)	Water	5310 C	EBMUD	No	HCL	NA
Organic carbon-Dissolved (WY 2015)	Water	5310 C	EBMUD	Yes	HCL	NA
Organic carbon-Total (WY 2016-2018)	Water	EPA 9060A	ALS	No	HCL	NA
Organic carbon-Dissolved (WY 2016, 2017)	Water	EPA 9060A	ALS	Yes	HCL	NA
Organic carbon (WY 2016, 2017)	Particulate	EPA 440.0	ALS	NA	NA	NA

⁷ Samples were analyzed for 40 PCB congeners (PCB-8, PCB-18, PCB-28, PCB-31, PCB-33, PCB-44, PCB-49, PCB-52, PCB-56, PCB-60, PCB-66, PCB-70, PCB-74, PCB-87, PCB-95, PCB-97, PCB-99, PCB-101, PCB-105, PCB-110, PCB-118, PCB-128, PCB-132, PCB-138, PCB-141, PCB-149, PCB-151, PCB-153, PCB-156, PCB-158, PCB-170, PCB-174, PCB-177, PCB-180, PCB-183, PCB-187, PCB-194, PCB-195, PCB-201, PCB-203).

2.4 Interpretive methods

Estimated particle concentrations

The reconnaissance monitoring field protocol is designed to collect one composite sample during a single storm at each site to characterize concentrations found during storm flow. Measured PCB and Hg concentrations at a site could have large inter-storm variability related to storm size and intensity and antecedent conditions, as observed from previous studies when a large number of storms were sampled (Gilbreath et al., 2015a); this variability cannot be captured in a single composite sample. However, variability can be reduced if concentrations are normalized to SSC, which produces an estimate of the pollutant concentration associated with particles in the sample. The estimated particle concentration (EPC) has been demonstrated to have less inter-storm variability than whole-water concentrations, and it was therefore reasoned that the EPC is likely a better characterization of water quality at a site than water concentration alone and therefore a better metric for comparison between sites (McKee et al., 2012; Rügner et al., 2013; McKee et al., 2015). EPCs were used as the primary index to compare sites without regard to climate or rainfall intensity. For each analyte at each site the estimated particle concentration (ratio of mass of a given pollutant of concern to mass of suspended sediment) was computed for each composite water sample (Equation 1):

$$EPC (ng/mg) = (\text{pollutant concentration (ng/L)}) / (\text{SSC (mg/L)}) \quad (1)$$

Although normalizing PCB and Hg concentrations to SSC provides an improved metric to compare sites, climatic conditions can nonetheless influence relative ranking based on EPCs. The absolute nature of that influence may differ between watershed locations depending on source characteristics. For example, dry years or lower storm intensity might result in a greater estimated particle concentration for some watersheds if transport of the polluted sediment is triggered and there is little dilution of contaminant concentrations by erosion of less contaminated particles from other parts of the watershed. This is most likely to occur in mixed land-use watersheds with large amounts of pervious area. For other watersheds, the source may be a patch of polluted soil that can only be eroded and transported when antecedent conditions and/or rainfall intensity reach some threshold. In this instance, a false negative could occur during a small storm or dry year. Only with many years of data during many types of storms can such processes be identified.

Because of concerns regarding inter-storm variability, relative ranking of sites based on EPC data from only one or two storms should be interpreted with caution and added to a broad set of evidence. Such comparisons may be sufficient for providing evidence to differentiate a group of sites with higher pollutant concentrations from a contrasting group with lower pollutant concentrations (acknowledging the risk that some data for watersheds in this group will be false negatives). However, to generate information on the absolute relative ranking between individual sites, a more rigorous sampling campaign targeting many storms over many years would be required (c.f. the Guadalupe River study: McKee et al., 2017; McKee et al., 2018, or the Zone 4 Line A study: Gilbreath and McKee, 2015; McKee and Gilbreath 2015). Alternatively, a more advanced data analysis would need to be performed that takes into account a variety of parameters (PCB and suspended sediment sources and mobilization processes, PCB congeners, rainfall intensity, rainfall antecedence, flow production and volume) in the

normalization and ranking procedure. As mentioned above, the RMP has funded a project in CY 2018 to complete this type of investigation (McKee et al., in review).

Derivations of central tendency for comparisons with past data

A mean, median, geometric mean, time-weighted mean, or flow-weighted mean can all be used as measures of a dataset's central tendency. Most of these measures have been used to summarize data from RMP studies with discrete stormwater samples. However, to best compare composite data from WY 2015-2018 monitoring with previously collected discrete sample data, a slightly different approach was used to re-compute the central tendency of the discrete stormwater samples. A water composite collected over a single storm with timed intervals is equivalent to mixing all discrete samples collected during a storm into a single bottle. Mathematically, this is done by taking the sum of all PCB or HgT concentrations in discrete samples and dividing that by the sum of SSCs from the same samples collected within the same storm event (Equation 2):

$$EPC_{comp} \left(\frac{ng}{mg} \right) = \frac{\sum POC_{dis} \left(\frac{ng}{L} \right)}{\sum SSC_{dis} \left(\frac{mg}{L} \right)} \quad (2)$$

where EPC_{comp} is the estimated composite particle concentration for a site with discrete sampling, POC_{dis} is the pollutant concentration of the discrete sample at a site, and SSC_{dis} is suspended sediment concentration of a discrete sample at a site. Note that this method is mathematically not equivalent to averaging together the EPCs of each discrete PCB:SSC or HgT:SSC pair. Because of the use of this alternative method, EPCs reported here differ slightly from those reported previously for some sites (McKee et al., 2012; McKee et al., 2014; Wu et al., 2016).

3. Results and Discussion

This report presents data from all available stormwater data⁸ collected since 2002 when stormwater studies first began through SFEI contracts or RMP projects, not just the data collected for this WY 2015-18 reconnaissance monitoring study. The additional data primarily includes data collected in intensive loadings studies from WYs 2003-2010 and 2012-2014, a similar reconnaissance study done in WY 2011, and studies of green infrastructure done between 2010 and the present. The data are presented in the context of three key questions:

- a) What are the concentrations and EPCs observed at each of the sites based on the composite water samples?
- b) How do the EPCs measured at each of the sites for composite water samples compare to EPCs derived from samples collected by the remote suspended-sediment samplers?
- c) How do concentrations and EPCs relate to other trace contaminant concentrations and land use?

⁸ Similar data collected by BASMAA in Santa Clara and San Mateo Counties is not included in this report.

These data contribute to a broad effort to identify potential management areas, and the rankings based on either stormwater concentration or EPCs are part of a weight-of-evidence approach for locating and prioritizing areas that may be disproportionately impacting downstream water quality. As the number of sample sites has increased, the relative rankings of particular sites have changed, but the highest-ranking sites have generally remained in the top quarter of sites.

3.1 SSC stormwater concentrations

Suspended sediment concentrations from the 84 sampling locations ranged from 16 to 2626 mg/L, with a median of 93 mg/L. These statistics include about a quarter of watersheds with agricultural and uncompacted open spaces at percentages greater than 5%. When those watersheds are removed, 61 remain that are nearly wholly urban (maximum agricultural plus uncompacted open space equals 2.1%). Summary statistics for these urban watersheds are presented below in Table 4 as a whole, as well as broken down by county.

Table 4. Summary statistics of SSC (in mg/L) for urban watersheds with agricultural and uncompacted open space <2.2%.

	All Counties	Alameda	Contra Costa	San Mateo	Santa Clara
n	61	18	6	16	20
Minimum	16	60	41	16	27
10%	26	68	49	20	34
25%	44	81	53	25	45
50%	73	111	60	43	65
75%	132	178	110	62	119
90%	182	388	123	183	149
Maximum	671	671	151	265	250

3.2 PCBs stormwater concentrations and estimated particle concentrations

Total PCB concentrations from the 83 sampling sites⁹ ranged from 533 to 448,000 pg/L excluding one sample that was <MDL (Table 5). Based on water composite concentrations for all available data, the 10 highest ranking sites for PCBs are (in order from higher to lower): Pulgas Pump Station-South, Santa Fe Channel, Industrial Rd Ditch, Line 12H at Coliseum Way, Sunnyvale East Channel, Pulgas Pump Station-North, Ettie Street Pump Station, Ridder Park Dr Storm Drain, Gull Dr. Outfall, and Outfall to Lower Silver Creek (Table 5, Figure 3). We often associate high PCB concentrations with old industrial land use, but these results suggest there is not a perfect correlation; the old industrial land use for these top-10 sites ranges from 3-79% (mean 40%, median 47%), highlighting the challenge of using land use alone as a guide to identify high leverage areas. Rather, localized sources (e.g. former transformer manufacturing

⁹ There are 84 sites in Table 5 but one site, San Pedro Stormdrain, only analyzed samples for Hg, not PCBs.

location) are likely the most important factor controlling PCB concentrations, and these sources frequently are located in old industrial areas.

Using PCB EPCs, the highest-ranking sites are: Pulgas Pump Station-South, Industrial Rd Ditch, Line 12H at Coliseum Way, Santa Fe Channel, Gull Dr SD, Pulgas Pump Station-North, Outfall to Colma Ck on service road near Littlefield Ave., Outfall to Lower Silver Creek, Ettie Street Pump Station, and South Linden Ave. SD. There was good correspondence between the sites ranked highest based on stormwater concentrations and those ranked highest based on EPCs. Seven sampling sites are on both of the lists of the top-10 highest-ranking sites (Figure 4); most sites in the top-10 for either concentrations or EPCs were within the top-20 of the other list, while only one site (South Linden Ave. SD) was ranked high (10th) in EPCs but low on water concentration (35th) because of very low suspended sediment concentration. Figure 3 shows how each year, one or more sites of interest were identified through this sampling effort. Of the 10 sites added, WY 2018 sampling identified one more PCB site of interest.

The fact that there are watersheds that rank high in water concentration but low in EPC suggests that there are PCB sources present but that the EPC is diluted by relatively high loading of clean sediment (e.g. >75% of SSC, Table 5). Examples include Line 13A at end of slough (357 mg/L) and Line 12K at Coliseum Entrance (671 mg/L). Conversely, that there are watersheds that rank high in EPC but not high in water concentration suggests that mobilization of PCBs is high relative to sediment mobilization, often with samples having a relatively low SSC. In addition to South Linden Ave. SD (16 mg/L), other examples of this include Austin Ck at Hwy 37 (20 mg/L) and Kirker Ck at Pittsburg Antioch Hwy and Verne Roberts Circle (27 mg/L). This latter scenario is more likely to occur in watersheds that are highly impervious with little erosion and transport of clean sediment from undeveloped areas.

Most of the sites investigated have PCB EPCs that are higher than average conditions needed for attainment of the TMDL. The PCB load allocation of 2 kg from the TMDL (SFBRWQCB 2008) translates to a mean water concentration of 1,330 pg/L and a mean particle concentration of 1.4 ng/g. These calculations assume an annual average flow from small tributaries of 1.5 km³ (Wu et al., 2017) and an average annual suspended sediment load of 1.4 million metric tons (McKee et al., 2013). Only five sampling locations investigated to date (Gellert Park bioretention influent stormwater, Duane Ct. and Triangle Ave., East Antioch nr Trembath, Refugio Ck at Tsushima St. and Little Bull Valley) have a composite averaged PCB water concentration of <1,330 pg/L (Table 5) and none of 83 sampling locations have composite averaged PCB EPCs of <1.4 ng/g (Table 5; Figure 3). The lowest PCB EPC measured to date is for Marsh Creek (2.9 ng/g).

WYs 2015 through 2018 POC Reconnaissance Monitoring

Table 5. PCB and total mercury (HgT) water concentrations and estimated particle concentrations (EPCs) measured in the Bay Area based on all RMP data collected in stormwater since water year 2003 (83 sites in total for PCBs and 84 sites for HgT). The data are sorted from high-to-low for PCB EPC to provide preliminary information on potential leverage. Note: Ranks with a half number (.5) are the result of two watersheds with the same rank.

Watershed/ Catchment	County	Water Year sampled	Area(km2)	Impervious cover(%)	Old Industrial land use (%)	Polychlorinated biphenyls (PCBs)				Total Mercury (HgT)				Suspended Sediment Concentration (SSC)	
						Estimated Particle Concentration		Composite /mean water concentration		Estimated Particle Concentration		Composite /mean water concentration		Composite /mean water concentration	
						(ng/g)	Rank	(ng/L)	Rank	(ng/g)	Rank	(ng/L)	Rank	(mg/L)	Rank
Pulgas Pump Station-South	San Mateo	2011-2014	0.58	87%	54%	8222	1	448	1	350	45.5	19	58	54	62
Industrial Rd Ditch	San Mateo	2016	0.23	85%	79%	6139	2	160	3	535	27	14	68	26	79
Line 12H at Coliseum Way	Alameda	2017	0.97	71%	10%	2601	3	156	4	602	19	36	43	60	55
Santa Fe Channel	Contra Costa	2011	3.3	69%	3%	1295	4	198	2	570	22.5	86	12.5	151	22
Gull Dr SD	San Mateo	2016	0.30	78%	54%	903	5	39.8	11	320	51	5.4	81	43	70
Pulgas Pump Station-North	San Mateo	2011	0.55	84%	52%	893	6	60.3	6	400	39	24	54.5	60	55
Outfall to Colma Ck on service rd nr Littlefield Ave. (359)	San Mateo	2017	0.09	88%	87%	788	7	33.9	16	210	65	9	78	43	68
Outfall to Lower Silver Creek	Santa Clara	2015	0.17	79%	78%	783	8	44.6	10	420	36	24	54.5	57	60
Ettie Street Pump Station	Alameda	2011	4.0	75%	22%	759	9	59.0	7	690	14	55	24.5	80	48
S Linden Ave SD (291)	San Mateo	2017	0.78	88%	57%	736	10	11.8	35	775	10	12	74	16	84
Gull Dr Outfall	San Mateo	2016 & 2018	0.43	75%	42%	599	11	49.5	9	180	70.5	7.6	79	62	53
Austin Ck at Hwy 37	Solano	2017	4.9	61%	2%	573	12	11.5	37	640	17	13	72.5	20	83
Ridder Park Dr Storm Drain	Santa Clara	2015	0.50	72%	57%	488	13	55.5	8	330	49	37	42	114	32
MeekerWest	Contra Costa	2018	0.41	70%	69%	458	14	28.0	20	530	29	32	46	61	54

WYs 2015 through 2018 POC Reconnaissance Monitoring

Watershed/ Catchment	County	Water Year sampled	Area(km2)	Impervious cover(%)	Old Industrial land use (%)	Polychlorinated biphenyls (PCBs)				Total Mercury (HgT)				Suspended Sediment Concentration (SSC)	
						Estimated Particle Concentration		Composite /mean water concentration		Estimated Particle Concentration		Composite /mean water concentration		Composite /mean water concentration	
						(ng/g)	Rank	(ng/L)	Rank	(ng/g)	Rank	(ng/L)	Rank	(mg/L)	Rank
Outfall at Gilman St.	Alameda	2016 & 2018	0.84	76%	32%	451	15	37.2	13	2820	3	233	5	81	47
Line 12I at Coliseum Way	Alameda	2017	3.4	63%	9%	398	16	37.0	14	129	76	12	76	93	43
Sunnyvale East Channel	Santa Clara	2011	15	59%	4%	343	17	96.6	5	200	67	50	28	250	13
Line 3A-M at 3A-D	Alameda	2015	0.88	73%	12%	337	18	24.8	21	1170	4	86	12.5	74	49
North Richmond Pump Station	Contra Costa	2011-2014	2.0	62%	18%	241	19	13.2	33	810	9	47	29.5	58	58
Seaboard Ave Storm Drain SC-050GAC580	Santa Clara	2015	1.4	81%	68%	236	20	19.9	26	550	25	47	29.5	85	44
Line 12M at Coliseum Way	Alameda	2017	5.3	69%	22%	222	21	24.1	22	365	42	40	38	109	36
Line 4-E	Alameda	2015	2.0	81%	27%	219	22	37.4	12	350	45.5	59	21	170	19
Kirker Ck at Pittsburg Antioch Hwy and Verne Roberts Cir	Contra Costa	2017 & 2018	36.67	18%	5%	219	23	5.64	55	540	26	16	62	27	77
Glen Echo Creek	Alameda	2011	5.5	39%	0%	191	24	31.1	18	210	66	73	17	348	11
Seaboard Ave Storm Drain SC-050GAC600	Santa Clara	2015	2.8	62%	18%	186	25	13.5	32	530	28	38	40.5	73	50
Line 12F below PG&E station	Alameda	2017	10	56%	3%	184	26	21.0	25	373	40	43	35	114	32
South Linden Pump Station	San Mateo	2015	0.14	83%	22%	182	27	7.81	49	680	15	29	50	43	68
Taylor Way SD	San Mateo	2016	0.27	67%	11%	169	28	4.23	60	1156	5	29	51	25	80
Line 9-D	Alameda	2015	3.6	78%	46%	153	29	10.5	40	240	59.5	17	60.5	69	52
Meeker Slough	Contra Costa	2015 & 2018	7.3	64%	6%	140	30	7.91	48	770	11	45	32	57	61
Rock Springs Dr Storm Drain	Santa Clara	2015	0.83	80%	10%	128	31	5.25	56	930	7	38	40.5	41	71
GR outfall 066GAC900	Santa Clara	2018	0.17	66%	1%	125	32	3.36	65	644	16	17	59	27	77

WYs 2015 through 2018 POC Reconnaissance Monitoring

Watershed/ Catchment	County	Water Year sampled	Area(km2)	Impervious cover(%)	Old Industrial land use (%)	Polychlorinated biphenyls (PCBs)				Total Mercury (HgT)				Suspended Sediment Concentration (SSC)	
						Estimated Particle Concentration		Composite /mean water concentration		Estimated Particle Concentration		Composite /mean water concentration		Composite /mean water concentration	
						(ng/g)	Rank	(ng/L)	Rank	(ng/g)	Rank	(ng/L)	Rank	(mg/L)	Rank
Charcot Ave Storm Drain	Santa Clara	2015	1.8	79%	24%	123	33	14.9	29	560	24	67	19	121	31
Veterans Pump Station	San Mateo	2015	0.52	67%	7%	121	34	3.52	64	470	32	14	67	29	76
Gateway Ave Storm Drain	San Mateo	2015	0.36	69%	52%	117	35	5.24	57	440	33	20	57	45	66
Guadalupe River at Hwy 101	Santa Clara	2003-2006, 2010, 2012-2014	233	39%	3%	115	36	23.7	23	3600	2	603	1	560	5
Line 9D1 PS at outfall to Line 9D	Alameda	2016	0.48	88%	62%	110	37	18.1	28	720	13	118	8.5	164	20
Tunnel Ave Ditch	San Mateo	2016	3.0	47%	8%	109	38	10.5	39	760	12	73	18	96	39
Valley Dr SD	San Mateo	2016	5.2	21%	7%	109	39	10.4	41	276	57	27	53	96	39
Runnymede Ditch	San Mateo	2015	2.1	53%	2%	108	40	28.5	19	190	69	52	27	265	12
E Gish Rd Storm Drain	Santa Clara	2015	0.45	84%	70%	99	41	14.4	30	590	21	85	14	145	25
Line 3A-M-1 at Industrial Pump Station	Alameda	2015	3.4	78%	26%	96	42	8.92	43	340	47	31	47	93	42
Line 13A at end of slough	Alameda	2016	0.83	84%	68%	96	43	34.3	15	331	48	118	8.5	357	9
Line 12A at Shellmound	Alameda	2018	10.48	41%	6%	95	44	10.8	38	406	37	46	31	114	32
Rosemary St SD 066GAC550C	Santa Clara	2017	3.7	64%	11%	89	45	4.11	62	591	20	27	52	46	65
North Fourth St SD 066GAC550B	Santa Clara	2017	1.0	68%	27%	87	46	4.17	61	477	31	23	56	48	63
Zone 4 Line A	Alameda	2007-2010	4.2	68%	12%	82	47	18.4	27	170	72	30	49	176	18
Forbes Blvd Outfall	San Mateo	2016	0.40	79%	0%	80	48	1.84	73	637	18	15	66	23	81

WYs 2015 through 2018 POC Reconnaissance Monitoring

Watershed/ Catchment	County	Water Year sampled	Area(km2)	Impervious cover(%)	Old Industrial land use (%)	Polychlorinated biphenyls (PCBs)				Total Mercury (HgT)				Suspended Sediment Concentration (SSC)	
						Estimated Particle Concentration		Composite /mean water concentration		Estimated Particle Concentration		Composite /mean water concentration		Composite /mean water concentration	
						(ng/g)	Rank	(ng/L)	Rank	(ng/g)	Rank	(ng/L)	Rank	(mg/L)	Rank
Storm Drain near Cooley Landing	San Mateo	2015	0.11	73%	39%	79	49	6.47	53	430	34	35	44	82	46
Lawrence & Central Expwys SD	Santa Clara	2016	1.2	66%	1%	78	50	4.51	59	226	61	13	69.5	58	59
Condensa St SD	Santa Clara	2016	0.24	70%	32%	74	51	2.60	71	329	50	12	77	35	74
San Leandro Creek	Alameda	2011- 2014	8.9	38%	0%	66	52	8.61	46	860	8	117	10	136	29
Oddstad Pump Station	San Mateo	2015	0.28	74%	11%	62	53	9.20	42	370	41	55	24.5	148	24
Line 4-B-1	Alameda	2015	1.0	85%	28%	57	54	8.67	45	280	55.5	43	34	152	21
Line 12A under Temescal Ck Park	Alameda	2016	9.4		1%	54	55	7.80	50	290	54	42	36	143	26
Victor Nelo PS Outfall	Santa Clara	2016	0.58	87%	4%	51	56	2.29	72	351	43	16	64	45	66
Line 12K at Coliseum Entrance	Alameda	2017	16	31%	1%	48	57	32.0	17	429	35	288	4	671	4
GR outfall 066GAC850	Santa Clara	2018	3.35	61%	6%	45	58	6.63	51	107	79	16	63	149	23
Haig St SD	Santa Clara	2016	2.1	72%	10%	43	59	1.45	75	194	68	7	80	34	75
Colma Ck at S. Linden Blvd	San Mateo	2017	35	41%	3%	37	60	2.65	70	215	64	15	65	71	51
Line 12J at mouth to 12K	Alameda	2017	8.8	30%	2%	35	61	6.48	52	401	38	73	16	183	17
S Spruce Ave SD at Mayfair Ave (296)	San Mateo	2017	5.1	39%	1%	30	62	3.36	66	350	44	39	39	111	35
Lower Coyote Creek	Santa Clara	2005	327	22%	1%	30	63	4.58	58	240	59.5	34	45	142	28
Calabazas Creek	Santa Clara	2011	50	44%	3%	29	64	11.5	36	150	75	59	21	393	7
E Outfall to San Tomas at Scott Blvd	Santa Clara	2016	0.67	66%	31%	27	65	2.80	69	127	77	13	69.5	103	38
San Lorenzo Creek	Alameda	2011	125	13%	0%	25	66	12.9	34	180	70.5	41	37	228	15

WYs 2015 through 2018 POC Reconnaissance Monitoring

Watershed/ Catchment	County	Water Year sampled	Area(km2)	Impervious cover(%)	Old Industrial land use (%)	Polychlorinated biphenyls (PCBs)				Total Mercury (HgT)				Suspended Sediment Concentration (SSC)	
						Estimated Particle Concentration		Composite /mean water concentration		Estimated Particle Concentration		Composite /mean water concentration		Composite /mean water concentration	
						(ng/g)	Rank	(ng/L)	Rank	(ng/g)	Rank	(ng/L)	Rank	(mg/L)	Rank
Stevens Creek	Santa Clara	2011	26	38%	1%	23	67	8.16	47	220	62.5	77	15	350	10
Guadalupe River at Foxworthy Road/ Almaden Expressway	Santa Clara	2010	107	22%	0%	19	68	3.12	67	4090	1	529	2	129	30
Duane Ct and Ave Triangle SD	Santa Clara	2016	1.0	79%	23%	17	69	0.832	77	268	58	13	71	48	63
Lower Penitencia Creek	Santa Clara	2011, 2015	12	65%	2%	16	70	1.59	74	160	73.5	17	60.5	106	37
Borel Creek	San Mateo	2011	3.2	31%	0%	15	71	6.13	54	160	73.5	58	23	363	8
San Tomas Creek	Santa Clara	2011	108	33%	0%	14	72	2.83	68	280	55.5	59	21	211	16
Little Bull Valley	Contra Costa	2018	0.02	67%	2%	13	73	0.543	78	312	53	13	72.5	41	71
Zone 5 Line M	Alameda	2011	8.1	34%	5%	13	74.5	21.1	24	570	22.5	505	3	886	3
Belmont Creek	San Mateo	2011	7.2	27%	0%	13	74.5	3.60	63	220	62.5	53	26	241	14
Refugio Ck at Tsushima St	Contra Costa	2017	11	23%	0%	9	76	0.533	79	509	30	30	48	59	57
Walnut Creek	Contra Costa	2011	232	15%	0%	7	77	8.83	44	70	80	94	11	1343	2
Rodeo Creek at Seacliff Ct. Pedestrian Br.	Contra Costa	2017	23	2%	3%	5	78	13.9	31	45	81	119	7	2626	1
Lower Marsh Creek	Contra Costa	2011- 2014	84	10%	0%	3	79	1.45	76	110	78	44	33	400	6
San Pedro Storm Drain	Santa Clara	2006	1.3	72%	16%	No data	No data	No data	No data	1120	6	160	6	143	27
East Antioch nr Trembath	Contra Costa	2017	5.3	26%	3%	NR	NR	<MDL	NR	313	52	12	75	39	73
El Cerrito Bioretention Influent	Contra Costa	2012, 2014-15, 2017	0.00	74%	0%	310	NR	29.7	NR	196	NR	19	NR	96	41

WYs 2015 through 2018 POC Reconnaissance Monitoring

Watershed/ Catchment	County	Water Year sampled	Area(km2)	Impervious cover(%)	Old Industrial land use (%)	Polychlorinated biphenyls (PCBs)				Total Mercury (HgT)				Suspended Sediment Concentration (SSC)	
						Estimated Particle Concentration		Composite /mean water concentration		Estimated Particle Concentration		Composite /mean water concentration		Composite /mean water concentration	
						(ng/g)	Rank	(ng/L)	Rank	(ng/g)	Rank	(ng/L)	Rank	(mg/L)	Rank
Fremont Osgood Road Bioretention Influent	Alameda	2012, 2013	0.00	76%	0%	45	NR ^a	2.906	NR ^a	120	NR ^a	10	NR ^a	83	45
Gellert Park Daly City Library Bioretention Influent	San Mateo	2009	0.02	40%	0%	36	NR ^a	0.725	NR ^a	1010	NR ^a	22	NR ^a	22	82

DRAFT

WYs 2015 through 2018 POC Reconnaissance Monitoring

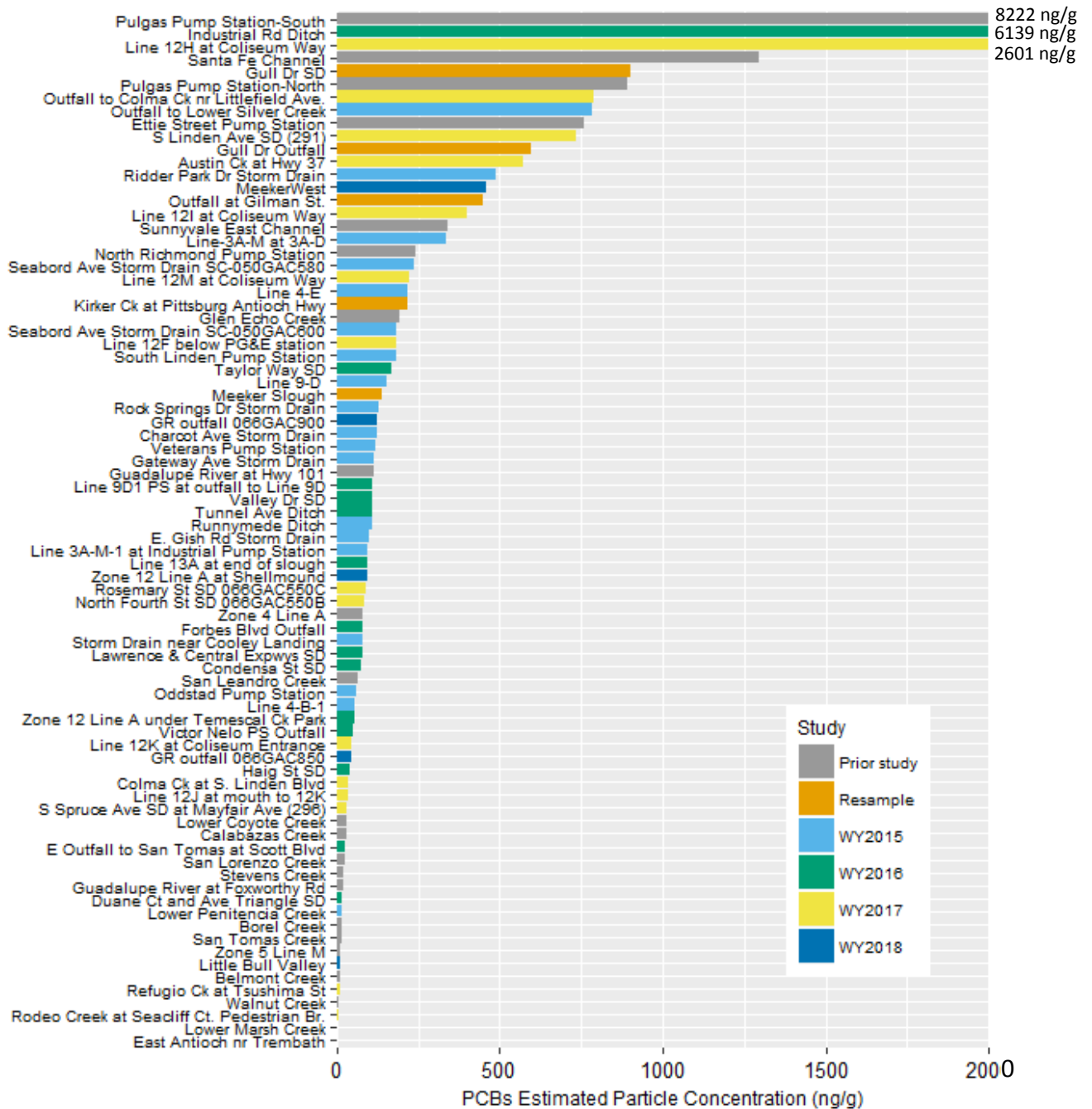

Figure 3. PCB estimated particle concentrations (EPCs) for watershed sampling sites measured to date (water years 2003-2018; where more than one storm is sampled at a site, the reported value is the average of the storm composite samples). Note that PCB EPCs for Pulgas Pump Station-South (8,222 ng/g), Industrial Road Ditch (6,139 ng/g), and Line 12H at Coliseum Way (2,601 ng/g) are beyond the extent of this graph. The sample count represented by each bar in the graph is provided in Appendix D.

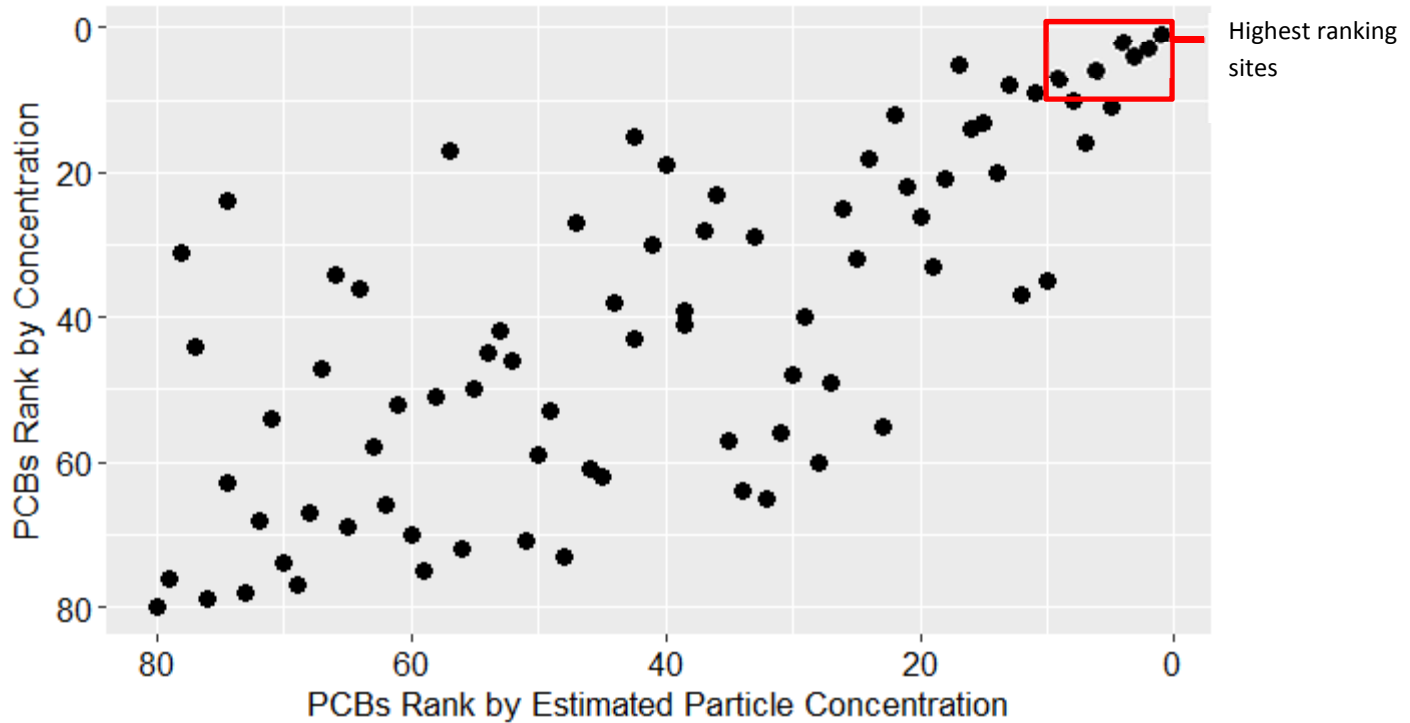

Figure 4. Comparison of site rankings for PCBs based on estimated particle concentrations (EPCs) versus water concentrations. 1 = highest rank; 80 = lowest rank.

3.3 Mercury stormwater concentrations and estimated particle concentrations

Total mercury concentrations in composite water samples ranged 110-fold from 5.4 to 603 ng/L, among the 84 sites sampled to date (Table 4). Based on water concentrations, the 10 highest ranking sites for HgT are the Guadalupe River at Hwy 101 (3% old industrial and with the legacy New Almaden Mining District upstream), Guadalupe River at Foxworthy Road/ Almaden Expressway (0% old industrial and with the legacy New Almaden Mining District upstream), Zone 5 Line M (5% old industrial), Line 12K at the Coliseum Entrance (1% old industrial), Outfall at Gilman St. (32% old industrial), San Pedro Storm Drain (16% old industrial), Rodeo Creek at Seacliff Ct. Pedestrian Br. (3% old industrial), Line 13-A at end of slough (68% old industrial), Line 9-D-1 PS at outfall to Line 9-D (62% old industrial) and San Leandro Creek (0% old industrial) (Table 4). These results suggest that there is no direct or strong positive relationship between mercury concentrations¹⁰ and old industrial land use, in contrast to the weak and positive relationship between concentrations measured in water and industrial land use for PCBs. None of these sites ranked among the 10 most highly-ranked sites for PCBs, also suggesting there is no direct relationship between mercury and PCBs in stormwater runoff in the Bay Area. Thus management of highly polluted PCB sites will not necessarily lead to multiple benefits that include similarly large reductions in Hg load.

¹⁰ There is a weak and negative relationship between old industrial land use and Hg concentrations in water.

There are several watersheds that have relatively low Hg concentrations. The HgT load allocation of 82 kg from the TMDL (SFBRWQCB, 2006) translates to a mean water concentration of 53 ng/L. These calculations assume an annual average flow from small tributaries of 1.5 km³ (Wu et al., 2017). Fifty-eight of 84 sampling locations have composite HgT water concentrations below this concentration (Table 4). There are likely few Hg sources in these watersheds besides atmospheric deposition¹¹.

Estimated particle concentrations ranged between 45 and 4090 ng/g. The 10 most polluted sites for HgT based on EPCs are Guadalupe River at Foxworthy Road/ Almaden Expressway, Guadalupe River at Hwy 101, Outfall at Gilman St., Line 3A-M at 3A-D, Taylor Way SD, San Pedro Storm Drain, Rock Springs Dr. Storm Drain, San Leandro Creek, North Richmond Pump Station and South Linden Ave. SD (Table 4; Figure 5). Management action in these watersheds might be most cost effective for reducing HgT loads. Only one of these 10 sites was among the 10 most highly-ranked sites for PCBs (South Linden Ave. SD), but 6 additional watersheds rank in the 20 most highly-ranked sites for both pollutants (Figure 6), providing the opportunity to address both PCBs and HgT. Twenty-five sites sampled to date have EPCs <250 ng/g, which, given a reasonable expectation of error of 25% around the measurements, could be considered equivalent to or less than 200 ng/g of Hg on suspended solids (the particulate Hg concentration specified in the Bay and Guadalupe River TMDLs (SFBRWQCB, 2006; 2008)).

Site ranking for HgT presents a different picture from PCBs. Sites ranking high based on water concentration are not necessarily ranked high for EPC (Figure 7). Given atmospheric deposition of Hg across the landscape (McKee et al., 2012), and the highly variable sediment erosion in Bay Area watersheds, it is possible that a watershed could have very elevated HgT stormwater concentrations but very low EPCs. The best example of this is Walnut Creek, which was ranked 11th (one of the highest) for stormwater composite HgT concentrations but 80th (nearly the lowest) on the basis of EPC. Therefore, ranking of sites for HgT should be approached more cautiously than for PCBs.

¹¹ Multiple studies in the Bay Area on atmospheric deposition rates for HgT reported very similar wet deposition rates of 4.2 µg/m²/y (Tsai and Hoenicke, 2001) and 4.4 µg/m²/y (Steding and Flegal, 2002), and Tsai and Hoenicke reported a total (wet + dry) deposition rate of 18-21 µg/m²/y. Tsai and Hoenicke computed volume-weighted mean mercury concentrations in precipitation based on 59 samples collected across the Bay Area of 8.0 ng/L. They reported that wet deposition contributed 18% of total annual deposition; scaled to volume of runoff, an equivalent stormwater concentration is 44 ng/L (8 ng/L/0.18 = 44 ng/L).

WYs 2015 through 2018 POC Reconnaissance Monitoring

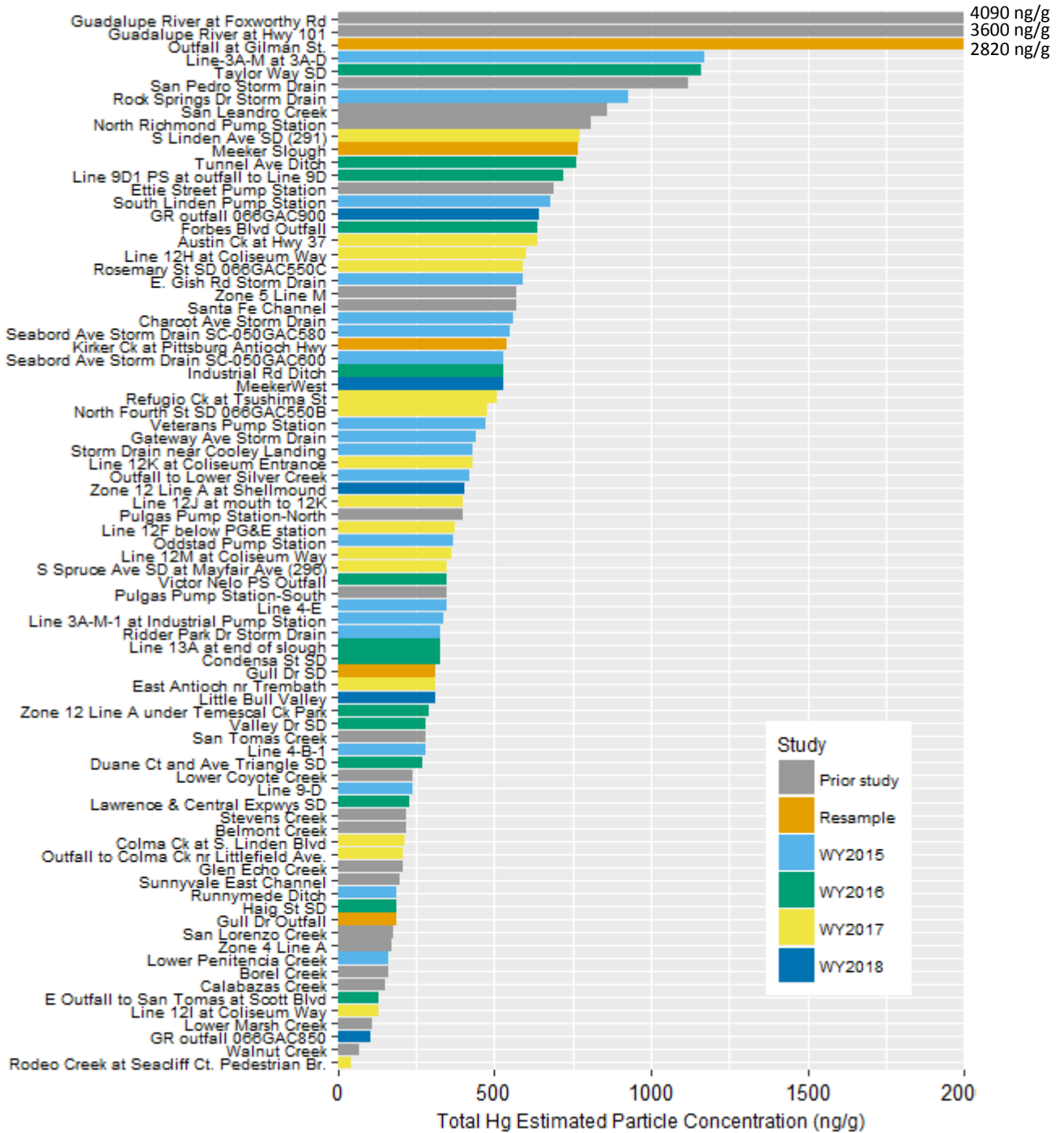

Figure 5. All watershed sampling locations measured to date (water years 2003-2018) ranked by total mercury (HgT) estimated particle concentrations (EPCs). The sample count represented by each bar in the graph is provided in Appendix D.

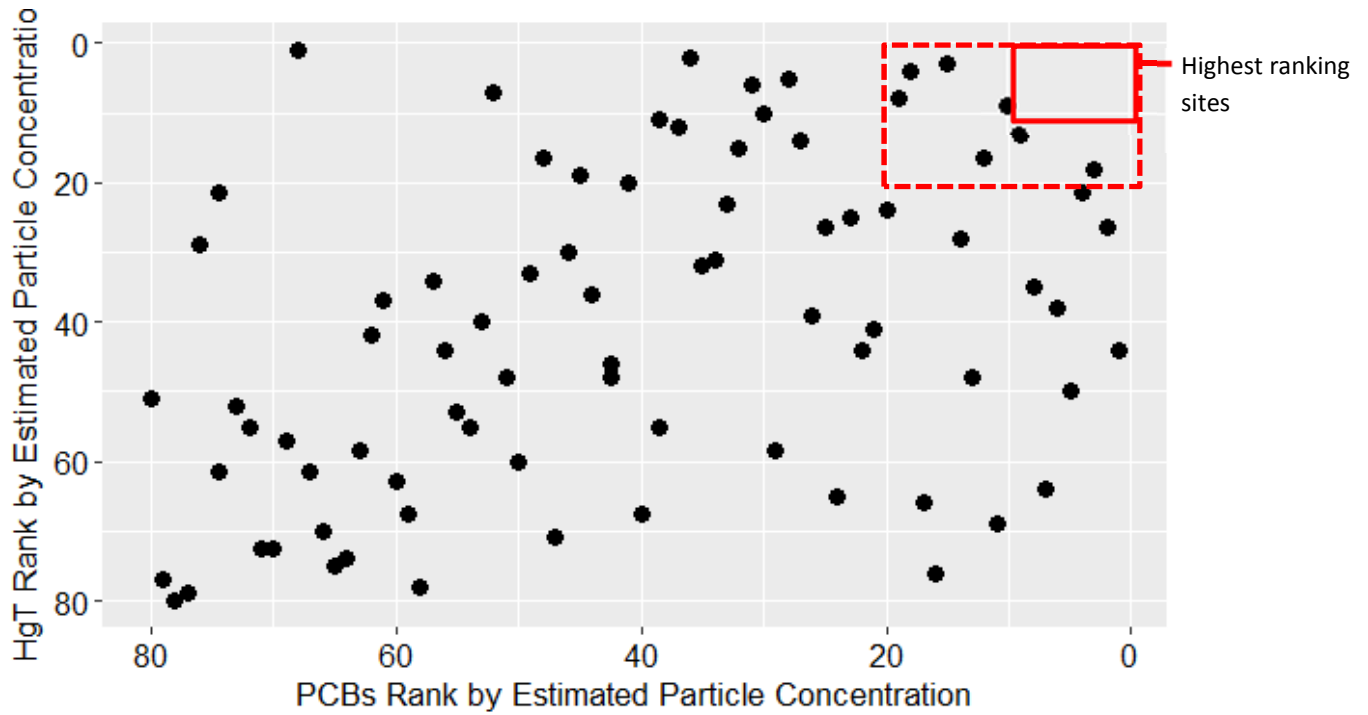

Figure 6. Comparison of site rankings for PCB and total mercury (HgT) estimated particle concentrations (EPCs). 1 = highest rank; 80 = lowest rank. One watershed ranks in the top 10 for both PCBs and HgT (in the solid red box), and seven watersheds rank in the top 20 for both pollutants (in the dashed red box).

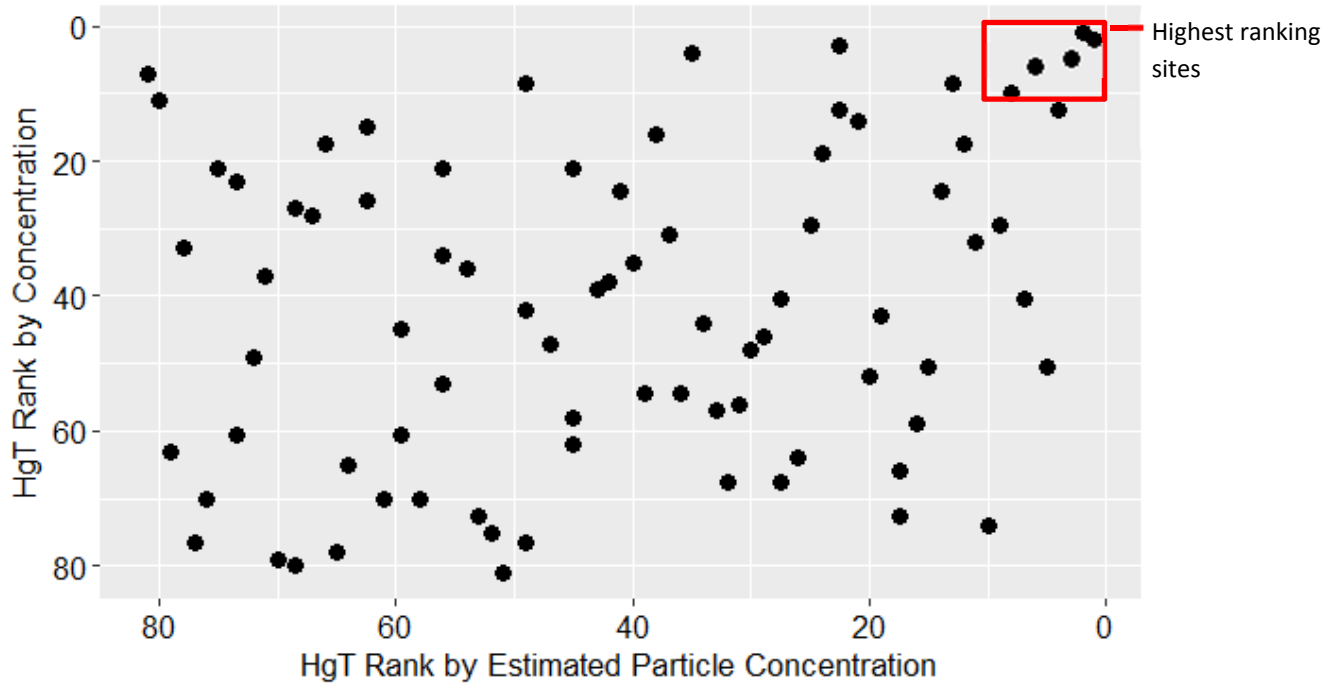

Figure 7. Comparison of site rankings for total mercury (HgT) estimated particle concentrations and water concentrations. 1 = highest rank; 81 = lowest rank.

3.4 Trace element (As, Cd, Cu, Mg, Pb, Se and Zn) concentrations

Trace metal (As, Cd, Cu, Pb and Zn) concentrations measured in selected watersheds during WYs 2015, 2016, and 2017 were similar in range to those previously measured in the Bay Area.

- **Arsenic (As):** Arsenic concentrations ranged from less than the MDL (0.34 µg/L for that sample) to 2.66 µg/L (Table 6). Total As concentrations of this magnitude have been measured in the Bay Area previously (Guadalupe River at Hwy 101: mean=1.9 µg/L; Zone 4 Line A: mean=1.6 µg/L) but are much lower than those measured at the North Richmond Pump Station (mean=11 µg/L) (Appendix A3 in McKee et al., 2015).
- **Cadmium (Cd):** Cadmium concentrations were 0.023-0.55 µg/L (Table 6). These Cd concentrations are similar to mean concentrations measured at Guadalupe River at Hwy 101 (0.23 µg/L), North Richmond Pump Station (mean = 0.32 µg/L), and Zone 4 Line A (mean = 0.25 µg/L) (Appendix A3 in McKee et al., 2015).
- **Copper (Cu):** Copper concentrations ranged from 3.63 to 52.7 µg/L (Table 6). These concentrations are typical of those measured in other Bay Area watersheds (mean concentrations for all of the following: Guadalupe River at Hwy 101: 19 µg/L; Lower Marsh Creek: 14 µg/L; North Richmond Pump Station: Cu 16 µg/L; Pulgas Pump Station-South: Cu 44 µg/L; San Leandro Creek: Cu 16 µg/L; Sunnyvale East Channel: Cu 18 µg/L; and Zone 4 Line A: Cu 16 µg/L) (Appendix A3 in McKee et al., 2015).
- **Lead (Pb):** Lead concentrations ranged from 0.910 to 21.3 µg/L (Table 6). Total Pb concentrations of this magnitude have been measured in the Bay Area previously (mean concentrations for all of the following: Guadalupe River at Hwy 101: 14 µg/L; North Richmond Pump Station: Pb 1.8 µg/L; and Zone 4 Line A: 12 µg/L) (Appendix A3 in McKee et al., 2015).
- **Zinc (Zn):** Zinc concentrations measured 39.4-337 µg/L (Table 6). Zinc measurements at 26 of the sites sampled during WYs 2015, 2016, and 2017 were comparable to mean concentrations measured in the Bay Area previously (Zone 4 Line A: 105 µg/L; Guadalupe River at Hwy 101: 72 µg/L) (see Appendix A3 in McKee et al., 2015).

In WY 2016, measurements of Mg (528-7350 µg/L) and Se (<MDL-0.39 µg/L) were added to the list of analytes. Both Mg and Se largely reflect geologic sources in watersheds. No measurements of Mg have been previously reported in the Bay Area. The measured concentrations of Se are on the lower end of previously reported values (North Richmond Pump Station: 2.7 µg/L; Walnut Creek: 2.7 µg/L; Lower Marsh Creek: 1.5 µg/L; Guadalupe River at Hwy 101: 1.3 µg/L; Pulgas Creek Pump Station - South: 0.93 µg/L; Sunnyvale East Channel: 0.62 µg/L; Zone 4 Line A: 0.48 µg/L; Mallard Island: 0.46 µg/L; Santa Fe Channel - Richmond: 0.28 µg/L; San Leandro Creek: 0.22 µg/L) (Table A3: McKee et al., 2015). Given the high proportion of Se transported in the dissolved phase and the inverse correlated with flow (David et al., 2015; McKee and Gilbreath, 2015; McKee et al., 2017), it is reasonable that the current sampling protocol, with a focus on high flow, measured lower concentrations than those measured with sampling designs that included low flow and baseflow samples (North Richmond Pump Station: 2.7 µg/L; Guadalupe River at Hwy 101: 1.3 µg/L; Zone 4 Line A: 0.48 µg/L; Mallard Island: 0.46 µg/L). Because of this sampling bias, care should be taken if the Se concentrations reported from this study were to be used in the future to estimate regional loads.

WYs 2015 through 2018 POC Reconnaissance Monitoring

Table 6. Concentrations of selected trace elements measured during winter storms of water years 2015, 2016, and 2017. The highest and lowest concentration for each trace element is in bold.

Watershed/Catchment	Sample Date	As (µg/L)	Cd (µg/L)	Cu (µg/L)	Pb (µg/L)	Mg (µg/L)	Se (µg/L)	Zn (µg/L)
Charcot Ave SD	4/7/2015	0.623	0.0825	16.1	2.02			115
Condensa St SD	1/19/2016	1.07	0.055	6.66	3.37	3,650	0.39	54.3
E. Gish Rd SD	12/11/2014	1.52	0.552	23.3	19.4			152
East Antioch nr Trembath	1/8/2017	1.57	0.119	3.53	1.68	5,363	0.53	36.3
Forbes Blvd Outfall	3/5/2016	1.5	0.093	31.7	3.22	7,350	<MDL	246
Gateway Ave SD	2/6/2015	1.18	0.053	24.3	1.04			78.8
Gull Dr SD	3/5/2016	<MDL	0.023	3.63	1.18	528	<MDL	39.4
Line 9-D-1 PS at outfall to Line 9-D	1/5/2016	1.07	0.524	22.5	20.9	2,822	0.2	217
Line 3A-M at 3A-D	12/11/2014	2.08	0.423	19.9	17.3			118
Line 3A-M-1 at Industrial PS	12/11/2014	1.07	0.176	14.8	7.78			105
Line 4-B-1	12/16/2014	1.46	0.225	17.7	8.95			108
Line 4-E	12/16/2014	2.12	0.246	20.6	13.3			144
Line 9-D	4/7/2015	0.47	0.053	6.24	0.91			67
Lower Penitencia Ck	12/11/2014	2.39	0.113	16.4	4.71			64.6
Meeker Slough	12/3/2014	1.75	0.152	13.6	14.0			85.1
North Fourth St SD 066GAC550B	1/8/2017	1.15	0.125	14.0	5.70	11,100	0.67	75.7
Oddstad PS	12/2/2014	2.45	0.205	23.8	5.65			117
Outfall to Lower Silver Ck	2/6/2015	2.11	0.267	21.8	5.43			337
Ridder Park Dr SD	12/15/2014	2.66	0.335	19.6	11.0			116
Rock Springs Dr SD	2/6/2015	0.749	0.096	20.4	2.14			99.2
Runnymede Ditch	2/6/2015	1.84	0.202	52.7	21.3			128
S Spruce Ave SD at Mayfair Ave (296)	1/8/2017	2.2	0.079	9.87	5.31	3,850	0.13	54.8
SD near Cooley Landing	2/6/2015	1.74	0.100	9.66	1.94			48.4
Seaboard Ave SD SC-050GAC580	12/11/2014	1.29	0.295	27.6	10.2			168
Seaboard Ave SD SC-050GAC600	12/11/2014	1.11	0.187	21	8.76			132
South Linden PS	2/6/2015	0.792	0.145	16.7	3.98			141
Taylor Way SD	3/11/2016	1.47	0.0955	10.0	4.19	5,482	<MDL	61.6
Veterans PS	12/15/2014	1.32	0.093	8.83	3.86			41.7
Victor Nelo PS Outfall	1/19/2016	0.83	0.140	16.3	3.63	1,110	0.04	118
Minimum		<MDL	0.023	3.53	0.91	528	<MDL	36.3
Maximum		2.66	0.552	52.7	21.3	11,100	0.67	337

3.5 Relationships between PCBs and Hg and other trace substances and land-cover attributes

Beginning in WY 2003, numerous sites have been evaluated for selected trace elements in addition to HgT. These sites include the fixed station loads monitoring sites on Guadalupe River at Hwy 101 (McKee et al., 2017, Zone 4 Line A (Gilbreath and McKee, 2015; McKee and Gilbreath, 2015), North Richmond Pump Station (Hunt et al., 2012) and four sites at which only Cu was measured (Lower Marsh Creek, San Leandro Creek, Pulgas Pump Station-South, and Sunnyvale East Channel) (Gilbreath et al., 2015a). Copper data were also collected at the inlets to several pilot performance studies for bioretention (El Cerrito: Gilbreath et al., 2012; Fremont: Gilbreath et al., 2015b), and Cu, Cd, Pb, and Zn data were collected at the Daly City Library Gellert Park demonstration bioretention site (David et al., 2015). During WYs 2015, 2016, and 2017, trace element data were collected at an additional 29 locations (Table 5). The pooled data comprise 39 sites for Cu; 33 for Cd, Pb, and Zn; and 32 for As. Data for Mg and Se were not included because of small sample size. Organic carbon has been collected at 28 locations in this study and an additional 21 locations in previous studies.

Spearman rank correlation analysis¹² was used to investigate relationships between EPCs of PCBs, HgT, and trace elements, and impervious land cover and old industrial land use (Table 6). Since the focus was on learning about pollutant covariance associated with urban land uses, HgT data associated with the main channel of the Guadalupe River were removed from the analysis because of historic mining influence in the watershed¹³. Estimated particle concentrations were chosen for this analysis for the same reasons as described above and in McKee et al. (2012): the influence of variable sediment production across Bay Area watersheds is best normalized out so that variations in the influence of pollutant sources and mobilization can be more easily observed between sites.

PCBs correlate positively with impervious cover, and old industrial land use, and correlate inversely with watershed area (Table 6). These observations are consistent with previous analysis (McKee et al., 2012), and make conceptual sense given that larger watersheds tend to have mixed land use and thus a lower proportional amount of PCB source areas versus the smaller watersheds that are more urbanized and more industrialized. There was also a positive but relatively weak correlation between PCBs and HgT, which is logical given the general relationships between impervious cover and old industrial land use and both PCBs and HgT. This observation contrasts with the conclusions drawn from the WY 2011 dataset, where there appeared to be more of a general correlation between PCBs and HgT (McKee et al., 2012). The difference between the studies might reflect a stronger focus on PCBs during the WY 2015-2018 sampling campaigns, which included more drainage-line outfalls to creeks with higher imperviousness and old industrial land use, or it might be an artifact of small sample size without sample representation along all environmental gradients. The weakness of the relationship may also partly be associated with

¹² The rank correlation was preferred because it makes no assumption of the type of relationship (linear or other) or the data distribution (normal data distribution is a requirement of a Pearson Product Moment correlation); in the Spearman correlation, every data pair has an equal influence on the coefficient.

¹³ Historic mining in the Guadalupe River watershed caused a unique positive relationship between Hg, Cr, and Ni, and unique inverse correlations between Hg and other typically urban metals such as Cu and Pb (McKee et al., 2017).

the larger role of atmospheric recirculation in the mercury cycle than the PCB cycle and large differences between the use history of each pollutant. PCBs are legacy contaminants that were used as dielectrics, plasticizers, and oils. Mercury was used in electronic devices, pressure and heat sensors, pigments, mildewcides, and dentistry, and has contemporary uses¹⁴ in addition to legacy use. Total Hg also has statistical relationships to the geospatial variables impervious cover, old industrial land use, and watershed area that are similar to but weaker than those for PCBs and these geospatial variables. Neither PCBs nor Hg are strongly correlated with other trace metals. Based on the analysis that uses the available pooled data, there is no support for the use of trace metals as a surrogate investigative tool for either PCB or HgT pollution sources.

To further explore relationships between PCBs, other pollutants, landscape and sediment characteristics, the PCB data were examined graphically (Figure 8). The graphs illustrate that the three highest PCB concentrations are in small watersheds that have a high proportion of impervious cover and old industrial area. But the lack of a stronger correlation between these metrics indicates that not all small, highly impervious watersheds have high PCB concentrations. The data also indicate the presence of outliers that may be worth exploring with additional data.

¹⁴ Some button-type batteries, cleansers, fireworks, folk medicines, grandfather clocks, pesticides, and skin-lightening creams and soaps still contain mercury, but domestic mercury consumption will continue to decline owing to increased use of LED lighting and consequent reduced use of conventional fluorescent tubes and compact fluorescent bulbs, and continued substitution of non-mercury-containing products, such as digital thermometers, and in measuring, control, and dental applications.

Table 6. Spearman Rank correlation matrix based on estimated particle concentrations (EPCs) of stormwater samples collected in the Bay Area since water year 2003 (see text for data sources and exclusions). Sample size in correlations ranged from 28 to 79. Values shaded in light blue have a *p* value <0.05.

	PCBs (pg/mg)	HgT (ng/mg)	Arsenic (ug/mg)	Cadmium (ug/mg)	Copper (ug/mg)	Lead (ug/mg)	Zinc (ug/mg)	Area (sq km)	% Imperviousness	% Old Industrial	% Clay (<0.0039 mm)	% Silt (0.0039 to <0.0625 mm)	% Sands (0.0625 to <2.0 mm)
HgT (ng/mg)	0.357												
Arsenic (ug/mg)	-0.61	-0.07											
Cadmium (ug/mg)	-0.28	0.23	0.67										
Copper (ug/mg)	-0.08	0.162	0.56	0.743									
Lead (ug/mg)	-0.25	0.179	0.583	0.863	0.711								
Zinc (ug/mg)	-0.25	0.266	0.497	0.801	0.894	0.691							
Area (sq km)	-0.41	-0.25	0.00	-0.23	-0.43	-0.08	-0.41						
% Imperviousness	0.529	0.25	-0.35	0.00	0.185	-0.10	0.173	-0.75					
% Old Industrial	0.588	0.233	-0.48	-0.2	-0.21	-0.25	-0.14	-0.52	0.735				
% Clay (<0.0039 mm)	0.272	0.135	-0.12	0.038	-0.23	-0.04	-0.16	-0.23	0.037	0.115			
% Silt (0.0039 to <0.0625 mm)	-0.13	0.07	-0.14	-0.18	0.274	0.00	0.168	0.206	-0.05	-0.06	-0.37		
% Sands (0.0625 to <2.0 mm)	-0.19	-0.24	0.094	0.008	-0.02	0.086	-0.02	0.285	-0.14	-0.11	-0.84	-0.05	
TOC (mg/mg)	0.258	0.427	0.70	0.60	0.875	0.466	0.756	-0.48	0.441	0.173	-0.13	0.118	-0.06

p value <0.05

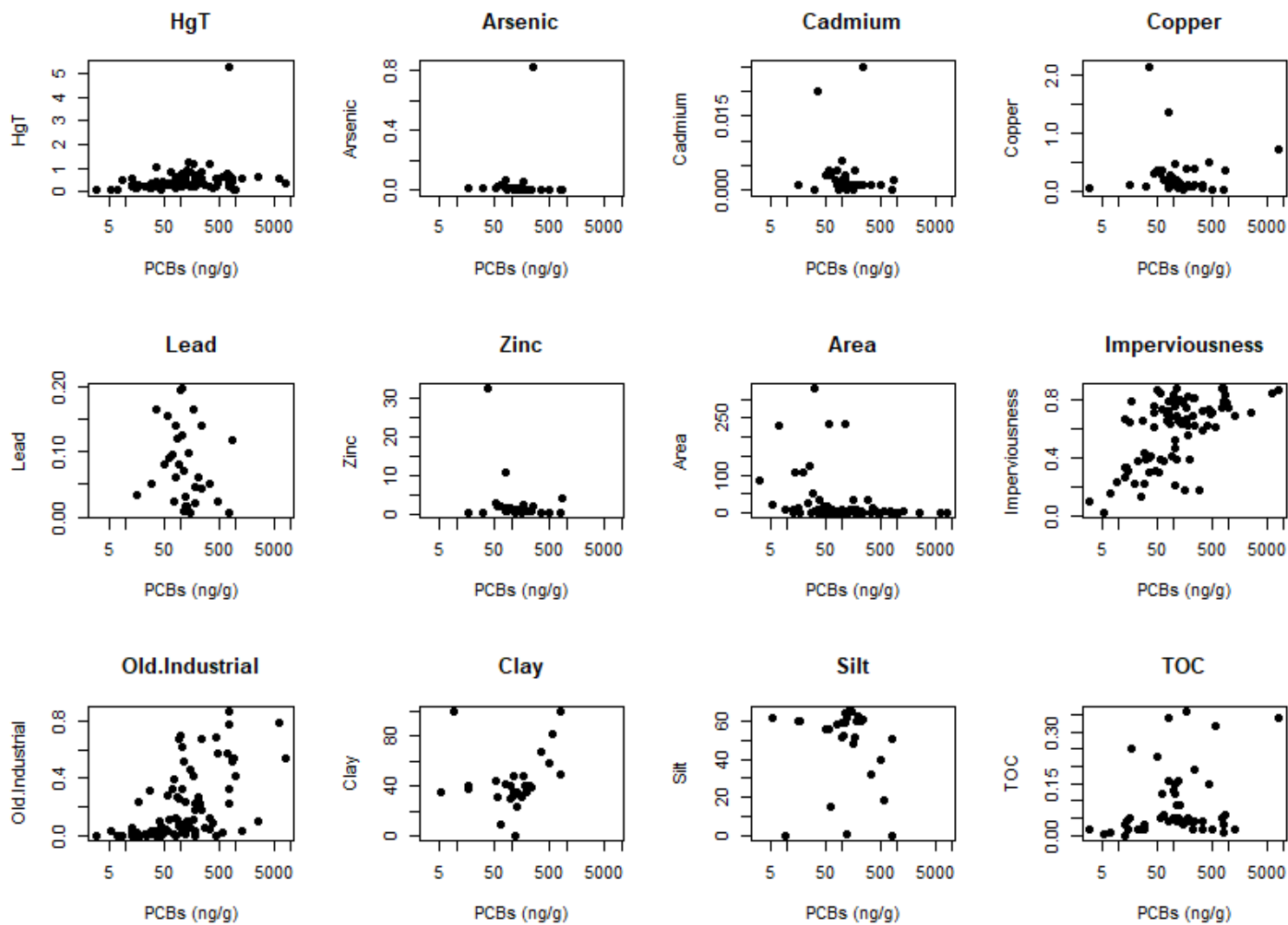

Figure 8. Relationships between observed estimated particle concentrations (EPCs) of PCBs and total mercury (HgT), trace elements, and impervious land cover and old industrial land use.

3.6 Comparison between remote and composite sampling methods

The results from remote suspended-sediment samplers were compared to those from the water composite samples collected in parallel (Table 7a and Table 7b). PCB EPCs in these manual water composite samples ranged widely from 5 to 788 ng/g. SSC for these same samples was generally below 100 mg/L, with the exception of one sample that was 121 mg/L and one sample that was a high outlier at 2626 mg/L. This outlier SSC sample is from a watershed with 67% agricultural and uncompacted open space, and was collected during a period in which the watershed was fully saturated (collected on 1/18/2017 after a large storm even approximately one week prior); therefore, the high SSC was not unexpected. Due to the high magnitude SSC, and relatively lesser mobilized PCBs in the watershed, the EPC at this site was only 5 ng/g. Conversely the site with the highest EPC (788 ng/g; Outfall to Colma Creek on service road near Littlefield Ave.) had a relatively low SSC at just 43 mg/L.

Mercury EPCs in the manual water composite samples in which remote samples were collected in parallel ranged three orders of magnitude from 45 to 1156 ng/g. Similar to the case for PCBs, the highest SSC sample also had the lowest Hg EPC, and the highest Hg EPC was measured in a sample with relatively low SSC (25 mg/L).

In addition to data shown in the tables, grain size was analyzed for the remote suspended sediment samples and the manual water composite samples collected in parallel. The grain-size distribution for the Walling tube samples agreed well with the manual water-composite samples (Figure 10). The grain-size distribution for the Hamlin samples typically was coarser than for the Walling tube or manual water composite samples. The results as they relate to grain size are discussed further below.

The EPCs for the samples from the remote samplers and manual water composites were compared to determine similarity of the results between the three differing field sampling techniques. The level of resemblance was determined following previously developed techniques (Bland and Altman, 1986; Dallal, 2012). The data were first plotted against one another for a basic visual inspection of scatter about the 1:1 line, and then the differences between concentrations measured in samples collected by the two methods were plotted against the mean of the two measurements to evaluate symmetric grouping around zero and systematic variation of the differences with the mean.

Results for Hg indicate that the Walling Tube samples were close to the 1:1 line with the stormwater samples (Figure 11A, B), and have no obvious bias (four samples are lower than the 1:1 line and two are higher). The Hamlin samples, however, were generally lower than the 1:1 line. The mean deviation of the paired sample differences (remote sample concentrations minus the water-composite sample concentrations) for the for Walling Tube sampler was -25 ng/g with a standard deviation of 170, whereas for the Hamlin sampler, the mean deviation was -241 ng/g and standard deviation was 275 ng/g. The smallest difference in Hg EPCs between the remote samplers and the composite water samples was at Rodeo Creek at Seacliff Ct. Pedestrian Br using a Walling Tube (RPD 9%); a difference this low could be entirely attributed to subsampling and analytical variation. However, at other sites the differences were as much as 5-fold and cannot be easily explained by subsampling or analytical variation. Instead, a possible explanation is that the manual water composite sample is collected using just 2 to 9 sub-samples whereas the remote sampler is a continuous time-integrated sample that

reduces the influence of momentary spikes in concentrations. That the remote sampler Hg EPCs are typically lower than the manual composites is conceptually in concordance with the findings in Yee and McKee (2010), with significant proportions of Hg in dissolved and slower settling fractions. This is consistent with the data (Table 7b), which indicate that, on average, 26% of the HgT was in the dissolved form (range 10-38%). Thus, these composited stormwater samples would be expected to have higher EPCs than would the remote samplers, resulting from lower sediment content and thus a greater relative proportion of Hg in the dissolved phase or on fine particles.

There is better agreement between PCB EPCs measured by the remote and manual sampling methods (Figure 11C, D). Those sites with high EPCs from composite samples also had high EPCs as measured from remote samples. The EPCs from remote samples were higher than those from the manual samples, a result that is conceptually reasonable but somewhat surprising, since the manual composite EPCs also included a dissolved proportion (mean 15%, median 12%; Table 7) that would elevate the manual composite EPC relative to a remote sample that has an insignificant dissolved phase contribution. There was one interesting outlier from the Hamlin remote sampler with EPC (1767 ng/g) elevated well above the manual water composite EPC (783 ng/g). A Walling Tube was also deployed at this location during the same storm and resulted with an EPC (956 ng/g), much more similar to the manual water composite EPC (783 ng/g). One hypothesis is that the remote samplers captured a time-limited pulse of PCBs during the storm but the manual composite subsampling missed the pulse. This hypothesis may not entirely explain the high concentration in the Hamlin samples, however, since the EPC from the Walling Tube sampler was only slightly elevated above the manual composite EPC. A key difference between the Hamlin sampler and the other two methods is that it disproportionately captures heavier and larger particles. These two ideas, taken together, may explain the very high Hamlin concentration – there may have been a time-limited pulse between manual samples causing both remote samplers to have relatively elevated concentrations, and a substantial portion of the PCBs flowing through this catchment may have been associated with slightly larger particles, which the Hamlin is more likely to capture than the Walling Tube.

The percentage dissolved phase in the PCB samples, where measured (n=9), ranged from 0 to 34% and did not correlate with the PCB EPC; the more polluted a site was did not translate into a larger percentage in dissolved phase. However, the disparity between the manual water composite and remote sampling methods (indicated in the far right hand column of the table titled “Comparative Ratio between Remote Sampler and Manual Water Composites”) was well correlated with the percentage dissolved in the manual water composite for each sampler (Figure 12). In other words, when more of a sample that was in the dissolved phase, the match between the manual water composite samples and the remote sampler samples was worse.

WYs 2015 through 2018 POC Reconnaissance Monitoring

Table 7a. Remote suspended-sediment sampler PCB data and comparison with manually collected composite water data. Note: EPC = estimated particle concentration.

Site	Remote Sampler Used	Manual Water Composite Data								Remote Sampler Data						
		SSC (manual composite) (mg/L)	PCBs Total (ng/L)	PCBs Particulate (ng/L)	PCBs Dissolved (ng/L)	% Dissolved	PCB particle concentration (lab measured on filter) (ng/g)	PCB EPC (ng/g)	Bias (EPC: lab measured)	PCB EPC (remote) (ng/g)	Comparative Ratio between Remote Sampler and Manual Water Composites					
Duane Ct and Ave Triangle SD (Jan 6)	Hamlin	48	0.8	0.55	0.28	34%	11	17	151%	43	246%					
Victor Nelo PS Outfall	Hamlin	45	2.3	2.0	0.28	12%	45	51	114%	70	137%					
Taylor Way SD	Hamlin	25	4.2	3.5	0.76	18%	139	169	122%	237	140%					
Tunnel Ave Ditch	Hamlin	96	10	9.9	0.60	6%	103	109	106%	150	137%					
Forbes Blvd Outfall	Hamlin	23	1.8	1.8	0.047	3%	78	80	103%	42	53%					
Charcot Ave SD	Hamlin	121	15	No data				123	No data	142	115%					
Outfall to Lower Silver Ck	Hamlin	57	45					783		1767	226%					
SD near Cooley Landing	Hamlin	82	6.5					79		68	87%					
Austin Ck at Hwy 37	Hamlin	20	11					573		700	122%					
Outfall at Gilman St	Hamlin	81	8.6					107		64	60%					
Outfall at Gilman St	Walling	81	8.6					107		144	135%					
MeekerWest	Walling	61	28					458		522	114%					
Outfall to Lower Silver Ck	Walling	57	45					783		956	122%					
Austin Ck at Hwy 37	Walling	20	11					573		362	63%					
Rodeo Creek at Seacliff Ct. Pedestrian Br.	Walling	2626	14					5		10	195%					
Victor Nelo PS Outfall	Walling	45	2.3					2.0		0.28	12%	45	51	114%	100	197%
Tunnel Ave Ditch	Walling	96	10					10		0.60	6%	103	109	106%	96	88%
Refugio Ck at Tsushima St	Walling	59	0.5					0.53		<MDL	0%	0	9	100000%	8	86%
Outfall to Colma Ck on service rd nr Littlefield Ave. (359)	Walling	43	34					37		1.0	3%	1	788	90428%	1172	149%
Median						6%			122%		122%					
Mean						11%			27289%		130%					

Table 7b. Remote suspended-sediment sampler Hg data and comparison with manually collected composite water data. Note: EPC = estimated particle concentration.

Site	Remote Sampler Used	Manual Water Composite Data								Remote Sampler Data	
		SSC (manual composite)	Hg Total (ng/L)	Hg Particulate (ng/L)	Hg Dissolved (ng/L)	% Dissolved	Hg particle concentration (lab measured on filter) (ng/g)	Hg EPC (ng/g)	Bias (EPC: lab measured)	Hg EPC (remote) (ng/g)	Comparative Ratio between Remote Sampler and Manual Water Composites
Duane Ct and Ave Triangle SD (Jan 6)	Hamlin	48	13	11	1.9	15%	229	268	117%	99	37%
Victor Nelo PS Outfall	Hamlin	45	16	12	3.7	23%	269	351	131%	447	127%
Taylor Way SD	Hamlin	25	29	18	11	38%	716	1156	161%	386	33%
Tunnel Ave Ditch	Hamlin	96	73	66	7.2	10%	685	760	111%	530	70%
Forbes Blvd Outfall	Hamlin	23	15	12	2.5	17%	530	637	120%	125	20%
Charcot Ave SD	Hamlin	121	67	No data				557	No data	761	137%
Outfall to Lower Silver Ck	Hamlin	57	24					423		150	36%
SD near Cooley Landing	Hamlin	82	35					427		101	24%
Austin Ck at Hwy 37	Hamlin	20	13					640		459	72%
Outfall at Gilman St	Hamlin	81	27					333		82	25%
Outfall at Gilman St	Walling	81	27					333		408	123%
MeekerWest	Walling	61	32					530		772	146%
Outfall to Lower Silver Ck	Walling	57	24					423		255	60%
Austin Ck at Hwy 37	Walling	20	13					640		548	86%
Rodeo Creek at Seacliff Ct. Pedestrian B	Walling	2626	119					45		50	110%
Victor Nelo PS Outfall	Walling	45	16	12	3.7	23%	269	351	131%	483	138%
Tunnel Ave Ditch	Walling	96	73	66	7.2	10%	685	760	111%	577	76%
Refugio Ck at Tsushima St	Walling	59	30	22	8.4	28%	366	509	139%	223	44%
Outfall to Colma Ck on service rd nr Littlefield Ave. (359)	Walling	43	9	9.7	4.9	54%	225	210	93%	264	125%
Median						23%			120%		72%
Mean						26%			125%		78%

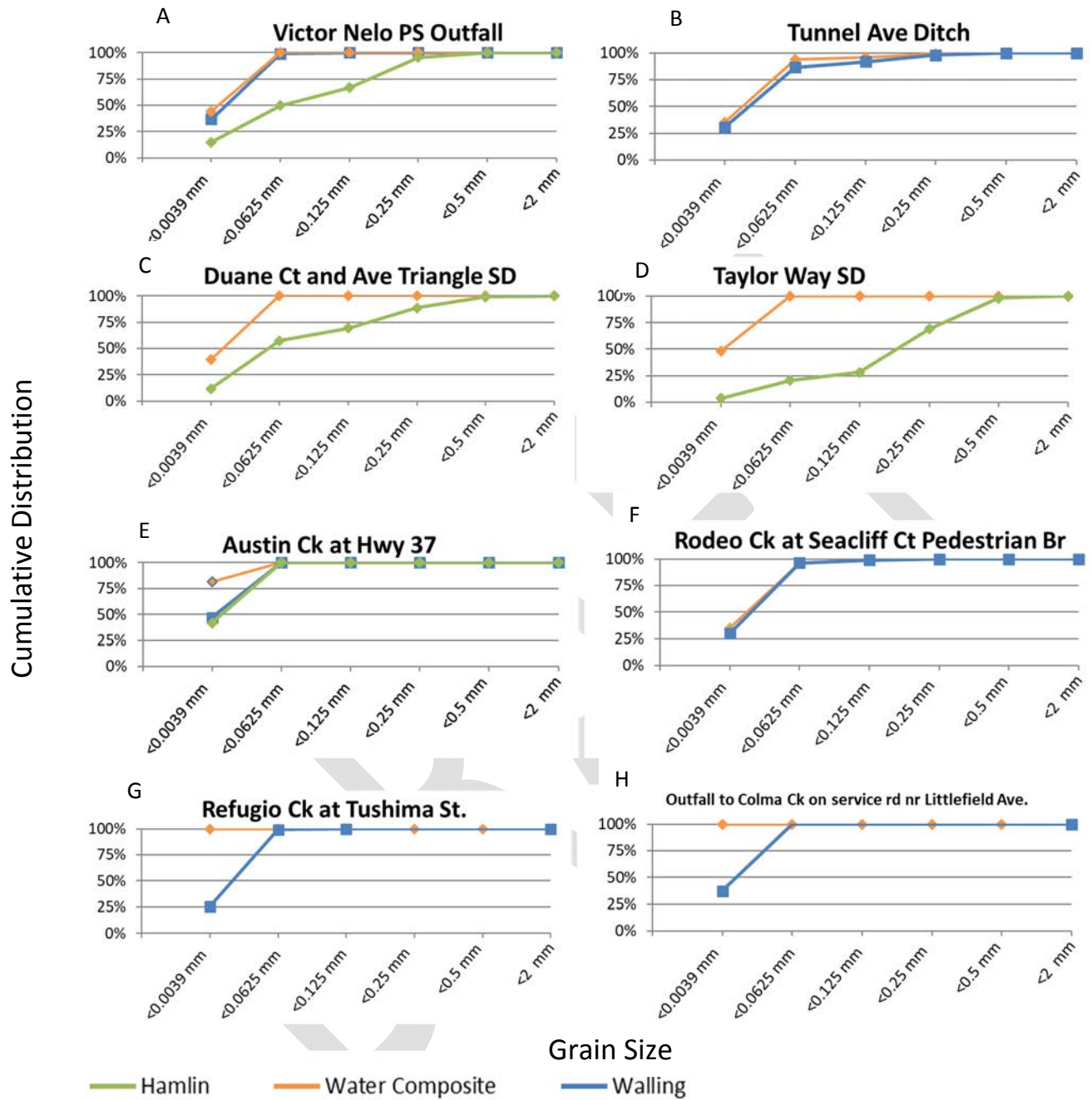

Figure 10. Cumulative grain size distribution in the Hamlin suspended-sediment sampler, Walling Tube suspended-sediment sampler, and water composite samples at eight of the sampling locations. Note that the two samplers were deployed together at only two of these eight sites.

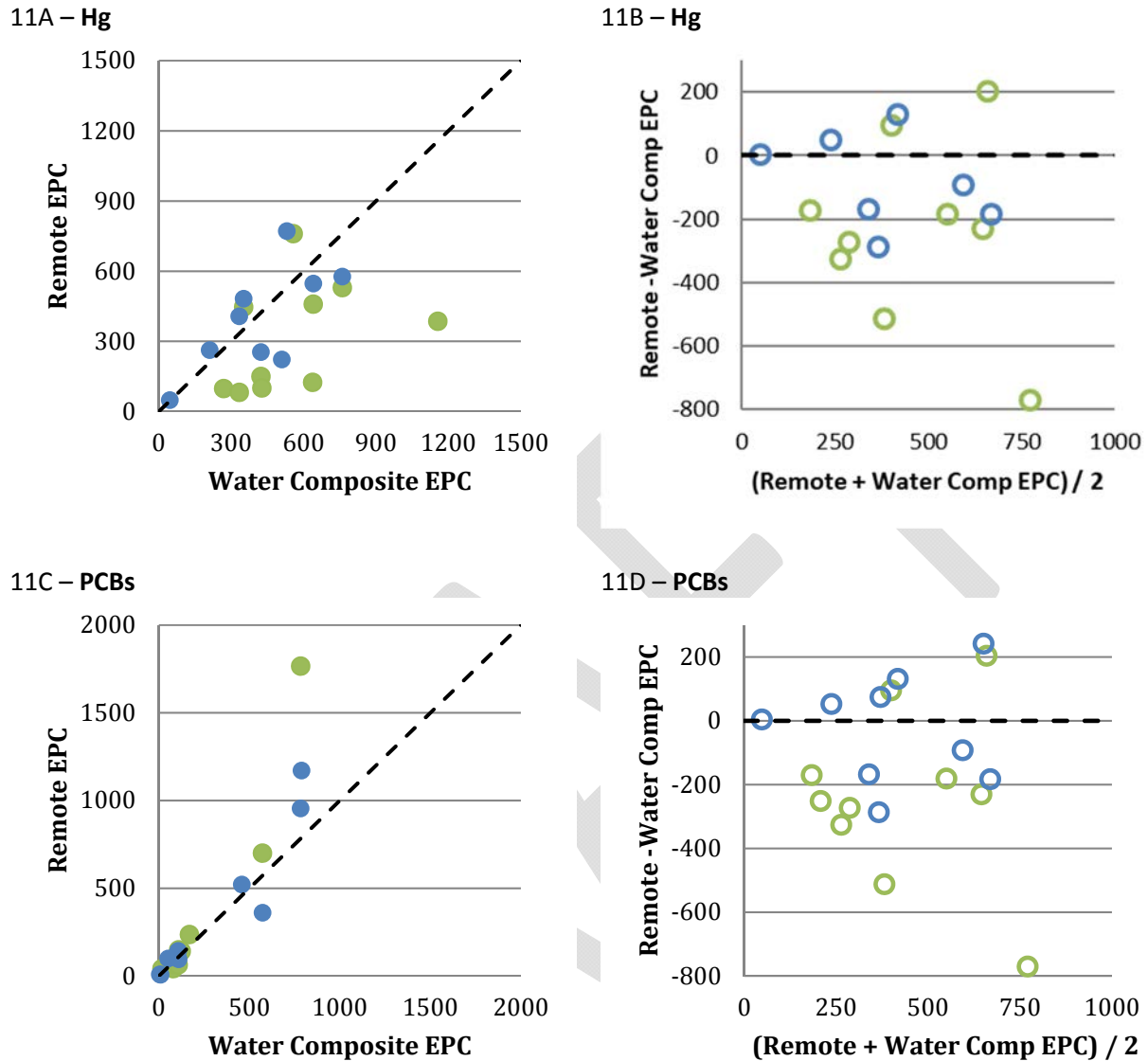

Figure 11. Estimated particle concentration comparisons between remote suspended-sediment samples versus manually collected composite samples, and comparisons of the differences between the methods against their means. Figures 11A and 11C show the 1:1 line (dashed black line), and Figures 11B and 11D show the zero line as dashed. Data for samples collected with the Hamlin sampler are green, and data for samples collected using the Walling Tube are blue.

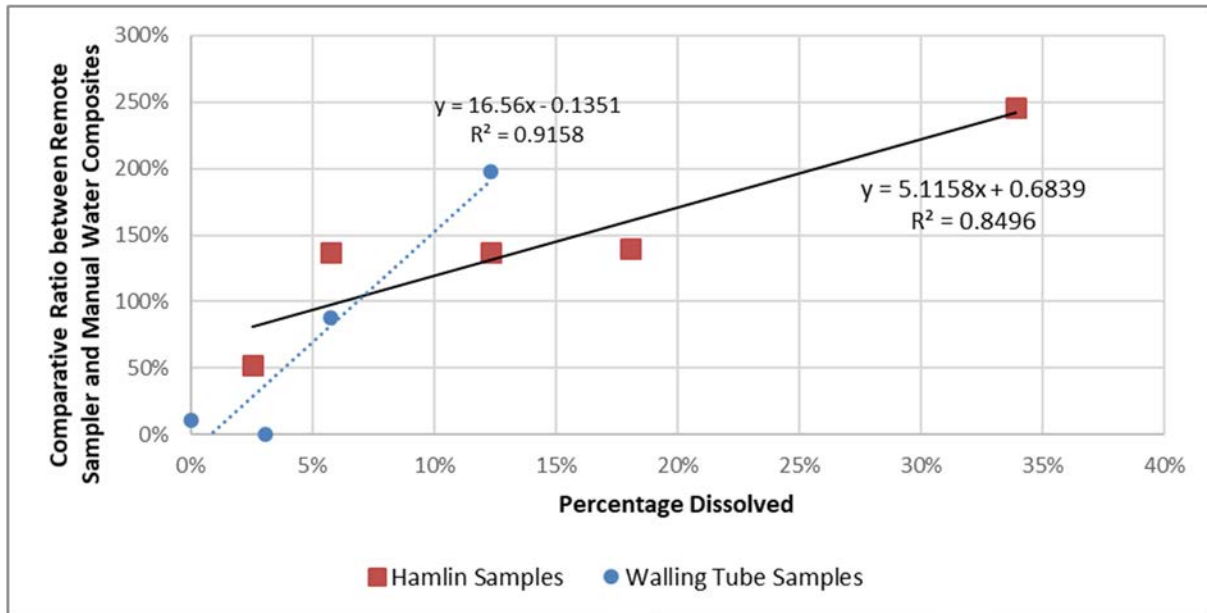

Figure 12. Comparative ratio between remote sampler and manual water composites as a function of the percentage dissolved in the manual water composite for each sampler.

While remote sampling methods could be used as an alternative for cost saving and in places where manual sampling is not feasible, interpreting the data from remote samples and comparing them to the composite water samples remains challenging. Whereas the remote methods collect primarily a concentrated, whole-storm-integrated suspended sediment sample, the manually composited water samples include a proportion of dissolved concentration, which confounds the metric of comparison (EPC) between the methods. In addition, although the Walling Tube does not, the data collected thus far from the Hamlin sampler has a different grain-size distribution than for data collected by the manual water composite method. Another challenge with the remote sampling data is that they cannot be used to estimate loads without corresponding sediment load estimates, which are not readily available.

In summary, remote samplers have shown promise as a screening tool based on data collected to date. The SPLWG has decided that the pilot phase of this study is now complete and recommended that the remote samplers are now ready for use as a low-cost screening tool to identify watersheds where greater investment in manual sampling and other methods of investigation may be needed. Reconnaissance characterization monitoring will continue into WY 2019, during which time remote samplers will be used for a portion of the effort, allowing the project to gather information at more sites for the same budget allocation.

3.7 Pros and cons of the remote sampling method

The pilot study to assess effectiveness of remote samplers is now complete. The samplers have been successfully deployed at 14 locations; the Hamlin sampler tested at ten locations and the Walling Tube sampler tested at nine locations. A comparison between remote sampling and manual sampling methods is described below and presented in Table 8a and 8b.

Cost: Both manual and remote sampling include many of the same costs, though manual sampling generally requires more staff labor related to tracking the storm carefully in order to deploy field staff at just the right time. Manual sampling requires more labor during long storms. There are some greater costs for remote sampling related to having to drive to the site twice (to deploy and then to retrieve) and then slightly more for post-sample processing, but these additional costs are minimal relative to the amount of time required to track storms and sample on site during the storm using the manual storm characterization protocol. Laboratory analytical costs are equivalent. See additional details in Table 8b below.

Sampling Feasibility: Remote sampling has a number of feasibility advantages over manual sampling. With remote sampling, manpower is less of a constraint; there is no need to wait on equipment (tubing, Teflon bottle, graduated cylinder) cleaning at the lab; the samplers can be deployed for longer than a single storm event, if desired; the samplers composite more evenly over the entire hydrograph; and conceivably, with the help of municipalities, remote samplers may be deployed in storm drains in logistically difficult locations such as the middle of streets. On the contrary, at this time there is no advantage to deploy remote samplers (and perhaps it is easier to just manually sample) in tidal locations since they must be deployed and retrieved within the same tidal cycle.

Data Quality: Comparison between the remote sampler and manual sampling results were assessed in this study. Both methods appear to reproduce similar trends – the highly polluted sites have high concentrations using both methods, and the lesser polluted sites have low concentrations for both methods. Although a more direct comparison of absolute measurements has not been studied, there does not seem to be a consistent systematic bias between the field protocols. It is not entirely clear which sampling method is superior for data quality because the remote samplers arguably miss the very finest fraction of sediments and dissolved phase portion, which is achieved in the manual water composite sampling. Yet the remote samplers have the benefit of sampling continuously throughout the storm and not missing any important pulses of pollutants through the flow path, versus manual water composite sampling in which only 3¹⁵ to 9 discrete aliquots are collected throughout a storm event. Additionally, if remote samplers are deployed over multiple storm events, it is reasonable to think that the extended sample collection would improve the representativeness of the sample. Because of these challenges in direct comparison, we suggest that the data quality for both methods is good for characterization, although for absolute comparison, the assessment is incomplete and would require a different study design to adequately compare.

Data Uses: At this time, the particle concentration data being collected using the remote sedimentation sampler methods will be used as a screening method for proposing further sampling at sites with elevated concentrations. We will continue to use data collected by the manual composite water sampling techniques for comparing sites. The water concentration data from the manual water

¹⁵ There were two exceptions in which only 2 aliquots were collected, Little Bull Valley and Outfall to Colma Ck on service rd nr Littlefield Ave. (359). At Little Bull Valley, flow was so minimal that 2 aliquots were sufficient to adequately characterize the runoff. At Out to Colma Ck on service rd nr Littlefield Ave. (359), a high tide cycle prevented collection during the middle of the storm; one aliquot was collected before and after the high tide cycle.

composites may also be used to estimate single storm loads if the volume is known or can be estimated (e.g., using the RWSM). Particle concentration data from remote samplers cannot be used for this purpose.

Human Stresses and Risks Associated with Sampling Protocol: Manual sampling involves a great deal of stressful planning and logistical coordination to sample storms successfully; these stresses include irregular schedules and having to cancel other plans; often working late and unpredictable hours; working in wet and often dark conditions after irregular or insufficient sleep and added risks under these cumulative stresses. Some approaches to remote sampling (e.g., not requiring exact coincidence with storm timing) could greatly reduce many of these stresses (and attendant risks).

Table 8a. Comparison of the advantages and disadvantages of the remote sampling method for screening sites for further investigation by sampling versus the manual sampling method ranking sites relative to each other to support management decisions.

Category	Remote Sampling Relative to Manual Sampling	Notes
Cost	Less	<ul style="list-style-type: none"> Less labor during storms when labor is the limiting factor. (See table 8b. below for additional details.)
Sampling Feasibility	Some advantages	<ul style="list-style-type: none"> Minimized cleaning time between storms Can be deployed over multiple storms Samplers composite more evenly over a storm Could be deployed by municipalities No advantage in tidal location
Data Quality	Good for characterization; for absolute comparison, assessment incomplete	<ul style="list-style-type: none"> Both methods appear to reproduce similar trends – the highly polluted sites have high concentrations using both methods, and the lesser polluted sites have low concentrations for both methods. May underrepresent the finest fractions, but sample continuously and do not miss any pulses.
Data Uses	Equivalent or slightly lower	<ul style="list-style-type: none"> Successful as a site screening tool. Unlike with manually collected samples, cannot be combined with volume (if known) to estimate loads.
Human stresses and risks associated with sampling protocol	Much less	<ul style="list-style-type: none"> Greatly reduced stress associated with storm planning and storm timing.

Table 8b. Labor and cost comparison between the remote sampling method for screening sites for further investigation by sampling versus the manual composite sampling method for the ranking sites relative to each other to support management decisions.

Task	Remote Sampling Labor Hours Relative to Manual Sampling	Manual Composite Sampling Task Description	Remote Sampling Task Description
Sampling Preparation in Office	Equivalent	Cleaning tubing/bottles; preparing bottles, field sampling basic materials	Cleaning sampler; preparing bottles, field sampling basic materials
Watching Storms	Much less	Many hours spent storm watching and deciding if/when to deploy	Storm watching is minimized to only identifying appropriate events with less/little concern about exact timing
Sampling Preparation at Site	Equivalent	Set up field equipment	Deploy sampler
Driving	More (2x)	Drive to and from site	Drive to and from site twice
Waiting on Site for Rainfall to Start	Less	Up to a few hours	No time since field crew can deploy equipment prior to rain arrival
On Site Sampling	Much less	10-20 person hours for sampling and field equipment clean up	2 person hours to collect sampler after storm
Sample Post-Processing	Slightly more (~2 person hours)	NA	Distribute composited sample into separate bottles; takes two people about 1 hour per sample
Data Management and Analysis	Equivalent	Same analytes and sample count (and usually same matrices)	Same analytes and sample count (and usually same matrices)

3.8 Sampling progress in relation to data uses

Sampling completed in older industrial areas can be used as an indicator of progress towards identifying areas for potential management. It has been argued previously that old industrial land use and the specific source areas found within or in association with older industrial areas are likely to have higher concentrations and loads of PCBs and HgT (McKee et al., 2012; McKee et al., 2015).

RMP sampling for PCBs and HgT since WY 2003 has included 34% of the old industrial land use in the region. The best coverage to date has occurred in Santa Clara County (61% of old industrial land use in the county is in watersheds that have been sampled), followed by Alameda County (30%) and San Mateo County (27%). In Contra Costa County, only 9% of old industrial land use is in watersheds that have been sampled, and just 1% in Solano County. The disproportional coverage in Santa Clara County is a result of sampling several large watersheds (Lower Penitencia Creek, Lower Coyote Creek, Guadalupe River at Hwy 101, Sunnyvale East Channel, Stevens Creek and San Tomas Creek) that have relatively large proportions of older industrial land use upstream from their sampling points. Of the remaining older industrial land use yet to be sampled, 49% of it lies within 1 km and 63% within 2 km of the Bay. These areas are more likely to be tidal and are likely to include heavy industrial areas that were historically serviced by rail and ship-based transport and military areas, but are often very difficult to sample because of a lack of public rights-of-way and tidal conditions. A different sampling strategy may

be required to effectively assess what pollution might be associated with these areas to better identify areas for potential management.

4. Summary and Recommendations

During WYs 2015-2018, composite water samples were collected at 65 sites during at least one storm event and analyzed for PCBs, HgT, and SSC, and, for a subset of samples, trace metals, organic carbon, and grain size. Sampling efficiency was increased, when possible, by sampling two nearby sites during a single storm. In parallel, a second sample was collected at 10 of the sampling sites using a Hamlin remote sedimentation sampler, and at nine sites using a Walling Tube sedimentation sampler. From this dataset, a number of sites with elevated PCB and HgT concentrations and EPCs were identified, in part because of an improved site selection process that focused on older industrial landscapes. The testing of the remote samplers showed positive results and beginning in WY 2019, the remote samplers will be used as a low-cost screening tool, for the first time unaccompanied by manual water composite sampling. Based on the WY 2015-2018 results, the following recommendations are made.

- Continue to select sites based on the four main selection objectives (Section 2.2). The majority of the sampling effort should be devoted to identifying potential high leverage areas with high unit area loads (yields) or concentrations/EPCs. Selecting sites by focusing on older industrial and highly impervious landscapes appears to be successful in identifying high leverage areas.
- Continue to use the composite sampling field protocol as developed and applied during WYs 2015-2018 without further modifications. In the event of a higher rainfall wet season, when there is a greater likelihood that more storm events will fall within the required tidal windows, it may be possible to sample tidally influenced sites.
- Develop a procedure for identifying sites that return lower-than-expected concentrations or EPCs and consider re-sampling those sites. This method is being developed currently in an advanced data analysis project.
- Positive results from the remote sampler study indicate that the samplers show promise as a screening tool. It is therefore recommended that future sampling can include the use of remote samplers as a low-cost screening tool to support decisions about possible further sampling using the reconnaissance characterization monitoring protocol.
- Develop an advanced data analysis method for identifying and ranking watersheds of management interest for further characterization or investigation. This recommendation will be implemented during the 2018 calendar year and possibly be ready to influence site selection in WY 2019.

5. References

- BASMAA, 2011. Small Tributaries Loading Strategy Multi-Year Plan (MYP) Version 2011. A document developed collaboratively by the Small Tributaries Loading Strategy Team of the Regional Monitoring Program for Water Quality in the San Francisco Estuary (RMP): Lester McKee, Alicia Gilbreath, Ben Greenfield, Jennifer Hunt, Michelle Lent, Aroon Melwani (SFEI), Arleen Feng (ACCWP) and Chris Sommers (EOA/SCVURPPP) for BASMAA, and Richard Looker and Tom Mumley (SFBRWQCB). Submitted to the Regional Water Board, September 2011, in support of compliance with the Municipal Regional Stormwater Permit, provision C.8.e.
http://www.swrcb.ca.gov/rwqcb2/water_issues/programs/stormwater/MRP/2011_AR/BASMAA/B2_2_010-11_MRP_AR.pdf
- Bland, J.M., Altman, D.G, 1986. Statistical methods for assessing agreement between two methods of clinical measurement. *The Lancet* 1, 307-310.
- Dallal, G.E. (2012): Comparing two measurement devices, Part I.
<http://www.jerrydallal.com/lhsp/compare.htm>
- David, N., Gluchowski, D.C, Leatherbarrow, J.E, Yee, D., and McKee, L.J, 2015. Estimation of Contaminant Loads from the Sacramento-San Joaquin River Delta to San Francisco Bay. *Water Environment Research*, 87 (April), 334-346.
<https://www.ingentaconnect.com/content/wef/wer/2015/00000087/00000004/art00007>
- David, N., Leatherbarrow, J.E, Yee, D., and McKee, L.J, 2015. Removal Efficiencies of a Bioretention System for Trace Metals, PCBs, PAHs, and Dioxins in a Semi-arid Environment. *J. of Environmental Engineering*, 141(6). [https://ascelibrary.org/doi/abs/10.1061/\(ASCE\)EE.1943-7870.0000921](https://ascelibrary.org/doi/abs/10.1061/(ASCE)EE.1943-7870.0000921)
- EOA, 2017a. Pollutants of Concern Monitoring - Data Report Water Year 2016. Prepared by Eisenberg Olivieri and Associates Incorporated (EOA, INC) for San Mateo Countywide Water Pollution Prevention Program (SMCWPPP) and submitted in compliance with NPDES Permit No. CAS612008 (Order No. R2-2015-0049), Provision C.8.h.iii. March 2017.
- EOA, 2017b. Pollutants of Concern Monitoring - Data Report Water Year 2016. Prepared by Eisenberg Olivieri and Associates Incorporated (EOA, INC) for Santa Clara Valley Urban Runoff Pollution Prevention Program (SCVURPPP) and submitted in compliance with NPDES Permit No. CAS612008 (Order No. R2-2015-0049), Provision C.8.h.iii. March 2017.
- Geosyntec Consultants, Inc. 2011. Final Remedial Action Plan, General Electric Site, 5441 International Boulevard, Oakland, California. June 30, 2011.
- Gilbreath, A. N., Pearce, S.A., and McKee, L. J., 2012. Monitoring and Results for El Cerrito Rain Gardens. Contribution No. 683. San Francisco Estuary Institute, Richmond, California.
http://www.sfei.org/sites/default/files/El%20Cerrito%20Rain%20Garden_FINALReport.pdf

WYs 2015 through 2018 POC Reconnaissance Monitoring

- Gilbreath, A.N., Hunt, J.A., Wu, J., Kim, P.S., and McKee, L.J., 2015a. Pollutants of concern (POC) loads monitoring progress report, water years (WYs) 2012, 2013, and 2014. A technical report prepared for the Regional Monitoring Program for Water Quality (RMP), Sources, Pathways and Loadings Workgroup (SPLWG), Small Tributaries Loading Strategy (STLS). Contribution No. 741. San Francisco Estuary Institute, Richmond, CA. <http://www.sfei.org/documents/pollutants-concern-poc-loads-monitoring-2012-2014>
- Gilbreath, A.N., Hunt, J.A., and McKee, L.J., 2015b. Hydrological response and pollutant removal by tree-well filter bioretention, Fremont, CA. A technical report of the Clean Water Program. SFEI Contribution No. 772. San Francisco Estuary Institute, Richmond, CA.
- Gilbreath, A.N. and McKee, L.J. 2015. Concentrations and loads of PCBs, dioxins, PAHs, PBDEs, OC pesticides and pyrethroids during storm and low flow conditions in a small urban semi-arid watershed. *Science of the Total Environment* 526 (September), 251-261. <https://www.sciencedirect.com/science/article/pii/S0048969715005033>
- Gilbreath, A. N.; Hunt, J. A.; Yee, D.; McKee, L. J. 2017. Pollutants of concern reconnaissance monitoring final progress report, water years 2015 and 2016. A technical report prepared for the Regional Monitoring Program for Water Quality (RMP), Sources, Pathways and Loadings Workgroup (SPLWG), Small Tributaries Loading Strategy (STLS). Contribution No. 817. San Francisco Estuary Institute, Richmond, CA. <http://www.sfei.org/documents/pollutants-concern-reconnaissance-monitoring-final-progress-report-water-years-2015-and>
- Homer, C.G., Dewitz, J.A., Yang, L., Jin, S., Danielson, P., Xian, G., Coulston, J., Herold, N.D., Wickham, J.D., and Megown, K. 2015. Completion of the 2011 National Land Cover Database for the conterminous United States-Representing a decade of land cover change information. *Photogrammetric Engineering and Remote Sensing*, v. 81, no. 5, p. 345-354.
- Hunt, J.A., Gluchowski, D., Gilbreath, A., and McKee, L.J., 2012. Pollutant Monitoring in the North Richmond Pump Station: A Pilot Study for Potential Dry Flow and Seasonal First Flush Diversion for Wastewater Treatment. A report for the Contra Costa County Watershed Program. Funded by a grant from the US Environmental Protection Agency, administered by the San Francisco Estuary Project. San Francisco Estuary Institute, Richmond, CA. http://www.sfei.org/sites/default/files/NorthRichmondPumpStation_Final_19112012_ToCCCWP.pdf
- Lubliner, B., 2012. Evaluation of Stormwater Suspended Particulate Matter Samplers. Toxics Studies Unit, Environmental Assessment Program, Washington State Department of Ecology, Olympia, Washington. <https://fortress.wa.gov/ecy/publications/summarypages/1203053.html>
- McKee, L.J., Gilbreath, A.N., Hunt, J.A., and Greenfield, B.K., 2012. Pollutants of concern (POC) loads monitoring data, Water Year (WY) 2011. A technical report prepared for the Regional Monitoring Program for Water Quality in San Francisco Bay (RMP), Small Tributaries Loading Strategy (STLS). Contribution No. 680. San Francisco Estuary Institute, Richmond, California. <http://www.sfei.org/documents/pollutants-concern-poc-loads-monitoring-data-water-year-wy-2011>

WYs 2015 through 2018 POC Reconnaissance Monitoring

- McKee, L.J., M. Lewicki, D.H. Schoellhamer, N.K. Ganju, 2013. Comparison of sediment supply to San Francisco Bay from watersheds draining the Bay Area and the Central Valley of California, In *Marine Geology*, Volume 345, Pages 47-62, ISSN 0025-3227, <https://doi.org/10.1016/j.margeo.2013.03.003>.
- McKee, L.J., Gilbreath, A.N., Wu, J., Kunze, M.S., Hunt, J.A., 2014. Estimating Regional Pollutant Loads for San Francisco Bay Area Tributaries using the Regional Watershed Spreadsheet Model (RWSM): Year's 3 and 4 Progress Report. A technical report prepared for the Regional Monitoring Program for Water Quality in San Francisco Bay (RMP), Sources, Pathways and Loadings Workgroup (SPLWG), Small Tributaries Loading Strategy (STLS). Contribution No. 737. San Francisco Estuary Institute, Richmond, California.
http://www.sfei.org/sites/default/files/737%20RWSM%20Progress%20Report%20Y3_4%20for%20the%20WEB.pdf
- McKee, L.J., and Gilbreath, A.N., 2015. Concentrations and loads of suspended sediment and trace element pollutants in a small semi-arid urban tributary, San Francisco Bay, California. *Environmental Monitoring and Assessment* 187(8) (August), 1-16. <https://link.springer.com/article/10.1007/s10661-015-4710-4>
- McKee, L.J. Gilbreath, N., Hunt, J.A., Wu, J., and Yee, D., 2015. Sources, Pathways and Loadings: Multi-Year Synthesis with a focus on PCBs and Hg. A technical report prepared for the Regional Monitoring Program for Water Quality in San Francisco Bay (RMP), Sources, Pathways and Loadings Workgroup (SPLWG), Small Tributaries Loading Strategy (STLS). Contribution No. 773. San Francisco Estuary Institute, Richmond, Ca. <http://www.sfei.org/documents/sources-pathways-and-loadings-multi-year-synthesis-pcb-and-hg>
- McKee, L. J.; Bonnema, A.; David, N.; Davis, J. A.; Franz, A.; Grace, R.; Greenfield, B. K.; Gilbreath, A. N.; Grosso, C.; Heim, W.; et al. 2017. Long-term variation in concentrations and mass loads in a semi-arid watershed influenced by historic mercury mining and urban pollutant sources. *Science of The Total Environment* 605-606, 482-497. SFEI Contribution No. 831.
<https://www.sciencedirect.com/science/article/pii/S0048969717310483>
- McKee, L.J., Gilbreath, A.N., Pearce, S.A. and Shimabuku, I., 2018. Guadalupe River mercury concentrations and loads during the large rare January 2017 storm. A technical report prepared for the Regional Monitoring Program for Water Quality in San Francisco Bay (RMP), Sources, Pathways and Loadings Workgroup (SPLWG). Contribution No. 837. San Francisco Estuary Institute, Richmond, California. <http://www.sfei.org/documents/guadalupe-river-mercury-concentrations-and-loads-during-large-rare-january-2017-storm>
- McKee, L.J., Gilbreath, A.N., Hunt, J.A., Wu, J., Yee, D., and Davis, J.A., in review. Pollutants of Concern, Small Tributaries Reconnaissance Monitoring Data: Site inter-comparison methodologies. Progress report: Year 1. A technical report prepared for the Regional Monitoring Program for Water Quality in San Francisco Bay (RMP), Sources, Pathways and Loadings Workgroup (SPLWG), Small Tributaries Loading Strategy (STLS). Contribution No. xxx. San Francisco Estuary Institute, Richmond, California.
www.xxx

WYs 2015 through 2018 POC Reconnaissance Monitoring

- Melwani, A.R., Yee, D., McKee, L., Gilbreath, A., Trowbridge, P., and Davis, J.A., 2018. Statistical Methods Development and Sampling Design Optimization to Support Trends Analysis for Loads of Polychlorinated Biphenyls from the Guadalupe River in San Jose, California, USA, Final Report. <https://www.sfei.org/documents/statistical-methods-development-and-sampling-design-optimization-support-trends-analysis>
- Phillips, J. M., Russell, M. A. and Walling, D. E. (2000), Time-integrated sampling of fluvial suspended sediment: a simple methodology for small catchments. *Hydrol. Process.*, 14: 2589–2602.
- Rügner et al., 2013. Turbidity as a proxy for total suspended solids (TSS) and particle facilitated pollutant transport in catchments. *Environmental Earth Sciences* 69 (2), 373-380.
- SFEI, 2009. RMP Small Tributaries Loading Strategy. A report prepared by the strategy team (L McKee, A Feng, C Sommers, R Looker) for the Regional Monitoring Program for Water Quality. SFEI Contribution #585. San Francisco Estuary Institute, Oakland, CA. <http://www.sfei.org/rmp/stls>
- SFBRWQCB, 2006. Mercury in San Francisco Bay: Proposed Basin Plan Amendment and Staff Report for Revised Total Maximum Daily Load (TMDL) and Proposed Mercury Water Quality Objectives. California Regional Water Quality Control Board San Francisco Bay Region, August 1st, 2006. 116pp. <http://www.waterboards.ca.gov/sanfranciscobay/TMDL/SFBayMercury/sr080906.pdf>
- SFBRWQCB, 2007. Total Maximum Daily Load for PCBs in San Francisco Bay Proposed Basin Plan Amendment and Staff Report. San Francisco Bay Regional Water Quality Control Board. Oakland, CA. December 4th, 2007. 178pp. <http://www.waterboards.ca.gov/sanfranciscobay/TMDL/SFBayPCBs/PCBsSR1207rev.pdf>
- SFBRWQCB, 2008. Guadalupe River Watershed Mercury Total Maximum Daily Load (TMDL) Project BASIN PLAN AMENDMENT. California Regional Water Quality Control Board San Francisco Bay Region October 8, 2008. http://www.waterboards.ca.gov/sanfranciscobay/water_issues/programs/TMDLs/guadalupe_river_mercury/Guad_Hg_TMDL_BPA_final_EOcorrSB_clean.pdf
- SFBRWQCB, 2009. California Regional Water Quality Control Board San Francisco Bay Region Municipal Regional Stormwater NPDES Permit, Order R2-2009-0074, Permit No. CAS612008. Adopted 10/14/2009. 279pp. http://www.waterboards.ca.gov/sanfranciscobay/water_issues/programs/stormwater/Municipal/index.shtml
- SFBRWQCB, 2011. California Regional Water Quality Control Board San Francisco Bay Region Municipal Regional Stormwater NPDES Permit, Order R2-2009-0074, NPDES Permit No. CAS612008. Adopted October 14, 2009. Revised November 28, 2011 http://www.waterboards.ca.gov/sanfranciscobay/water_issues/programs/stormwater/Municipal/R2-2009-0074_Revised.pdf

WYs 2015 through 2018 POC Reconnaissance Monitoring

SFBRWQCB, 2015. California Regional Water Quality Control Board San Francisco Bay Region Municipal Regional Stormwater NPDES Permit, Order R2-2015-0049, NPDES Permit No. CAS612008. Adopted November 15, 2015.

http://www.waterboards.ca.gov/sanfranciscobay/water_issues/programs/stormwater/Municipal/R2-2015-0049.pdf

SPLWG, 2014. Regional Monitoring Program for Water Quality (RMP), Sources, Pathways and Loadings Workgroup (SPLWG) meeting. May 2014. San Francisco Estuary Institute, Richmond, California.

<http://www.sfei.org/events/rmp-sources-pathways-and-loading-workgroup-meeting>

Steding, D. J. and Flegal, A. R. 2002. Mercury concentrations in coastal California precipitation: evidence of local and trans-Pacific fluxes of mercury to North America. Journal of Geophysical Research.

Tsai, P., and Hoenicke, R., 2001. San Francisco Bay atmospheric deposition pilot study Part 1: Mercury. San Francisco Estuary Institute, Oakland CA, July, 2001. 45pp.

http://www.sfei.org/rmp/reports/air_dep/mercury_airdep/ADHg_FinalReport.pdf

Wu, J., Gilbreath, A.N., and McKee, L.J., 2016. Regional Watershed Spreadsheet Model (RWSM): Year 5 Progress Report. A technical report prepared for the Regional Monitoring Program for Water Quality in San Francisco Bay (RMP), Sources, Pathways and Loadings Workgroup (SPLWG), Small Tributaries Loading Strategy (STLS). Contribution No. 788. San Francisco Estuary Institute, Richmond, CA.

http://www.sfei.org/sites/default/files/biblio_files/RWSM%202015%20FINAL.pdf

Wu, J., Gilbreath, A.N., McKee, L.J., 2017. Regional Watershed Spreadsheet Model (RWSM): Year 6 Progress Report. A technical report prepared for the Regional Monitoring Program for Water Quality in San Francisco Bay (RMP), Sources, Pathways and Loadings Workgroup (SPLWG), Small Tributaries Loading Strategy (STLS). Contribution No. 811. San Francisco Estuary Institute, Richmond, CA.

<http://www.sfei.org/documents/regional-watershed-spreadsheet-model-rws-year-6-final-report>

Yee, D.; Franz, A.; Wong, A.; Ross, J.; Trowbridge, P. 2017. 2017 Quality Assurance Program Plan for the Regional Monitoring Program for Water Quality in San Francisco Bay. SFEI Contribution No. 828. San Francisco Estuary Institute: Richmond, CA.

<http://www.sfei.org/documents/2017-quality-assurance-program-plan-regional-monitoring-program-water-quality-san-francisco-bay>

Yee, D., and McKee, L.J., 2010. Task 3.5: Concentrations of PCBs and Hg in soils, sediments and water in the urbanized Bay Area: Implications for best management. A technical report of the Watershed Program. SFEI Contribution 608. San Francisco Estuary Institute, Oakland CA 94621. 36 pp. + appendix.

http://www.sfei.org/sites/default/files/Concentrations%20of%20Hg%20PCBs%20in%20soils%20sediment%20and%20water%20in%20the%20urbanized%20Bay%20Area_0.pdf

Wu, J., Trowbridge, P., Yee, D., McKee, L., and Gilbreath, A., 2018. RMP Small Tributaries Loading Strategy: Trends Strategy 2018. Contribution No. 886. San Francisco Estuary Institute, Richmond, California.

<https://www.sfei.org/documents/rmp-small-tributaries-loading-strategy-trends-strategy-2018>

6. Appendices

Appendix A: Characteristics of Larger Watersheds

Characteristics of larger watersheds to be monitored, proposed sampling location, and proposed sampling trigger criteria. None of these watersheds were sampled during water years 2015, 2016 or 2018 because sampling trigger criteria for flow and rainfall were not met, and in WY 2017 large watershed sampling was focused on the Guadalupe River rather than the watersheds on this list.

Proposed sampling location							Relevant USGS gauge for 1st order loads computations	
Watershed system	Watershed Area (km ²)	Impervious Surface (%)	Industrial (%)	Sampling Objective	Commentary	Proposed Sampling Triggers	Gauge number	Area at USGS Gauge (sq ²)
Alameda Creek at EBRPD Bridge at Quarry Lakes	913	8.5	2.3	2, 4	Operating flow and sediment gauge at Niles just upstream will allow the computation of 1st order loads to support the calibration of the RWSM for a large, urbanizing type watershed.	7" of antecedent rainfall in Livermore (reliable web published rain gauge), after at least an annual storm has already occurred (~2000 cfs at the Niles gauge), and a forecast for the East Bay interior valleys of 2-3" over 12 hrs.	11179000	906
Dry Creek at Arizona Street (purposely downstream from historic industrial influences)	25.3	3.5	0.3	2, 4	Operating flow gauge at Union City just upstream will allow the computation of 1st order loads to support the calibration of the RWSM for mostly undeveloped land use type watersheds.	7" of antecedent rainfall in Union City, after at least a common annual storm has already occurred (~200 cfs at the Union City gauge), and a forecast for the East Bay Hills of 2-3" over 12 hrs.	11180500	24.3
San Francisquito Creek at University Avenue (as far down as possible to capture urban influence upstream from tide)	81.8	11.9	0.5	2, 4	Operating flow gauge at Stanford upstream will allow the computation of 1st order loads to support the calibration of the RWSM for larger mixed land use type watersheds. Sample pair with Matadero Ck.	7" of antecedent rainfall in Palo Alto, after at least a common annual storm has already occurred (~1000 cfs at the Stanford gauge), and a forecast for the Peninsula Hills of 3-4" over 12 hrs.	11164500	61.1
Matadero Creek at Waverly Street (purposely downstream from the railroad)	25.3	22.4	3.7	2, 4	Operating flow gauge at Palo Alto upstream will allow the computation of 1st order loads to support the calibration of the RWSM for mixed land use type watersheds. Sample pair with San Francisquito Ck.	7" of antecedent rainfall in Palo Alto, after at least a common annual storm has already occurred (~200 cfs at the Palo Alto gauge), and a forecast for the Peninsula Hills of 3-4" over 12 hrs.	11166000	18.8
Colma Creek at West Orange Avenue or further downstream (as far down as possible to capture urban and historic influence upstream from tide)	27.5	38	0.8	2, 4 (possibly 1)	Historic flow gauge (ending 1996) in the park a few hundred feet upstream will allow the computation of 1st order loads estimates to support the calibration of the RWSM for mixed land use type watersheds.	Since this is a very urban watershed, precursor conditions are more relaxed: 4" of antecedent rainfall, and a forecast for South San Francisco of 2-3" over 12 hrs. Measurement of discharge and manual staff plate readings during sampling will verify the historic rating.	11162720	27.5

Appendix B – Sampling Method Development

The monitoring protocol implemented in WYs 2015-2018 was based on a previous monitoring design that was trialed in WY 2011 when multiple sites were visited during one or two storm events. In that study, multiple discrete stormwater samples were collected at each site and analyzed for a number of POCs (McKee et al., 2012). At the 2014 SPLWG meeting, an analysis of previously collected stormwater sample data from both reconnaissance and fixed station monitoring was presented (SPLWG et al. 2014). A comparison of three sampling designs for Guadalupe River at Hwy 101 (sampling 1, 2, or 4 storms, respectively: functionally 4, 8, and 16 discrete samples) showed that PCB estimated particle concentrations (EPC) at this site can vary from 45-287 ng/g (1 storm design), 59-257 ng/g (2 storm design), and 74-183 ng/g (4 storm design) between designs, suggesting that the number of storms sampled for a given watershed has big impacts on the EPCs and therefore the potential relative ranking among sites. A similar analysis that explores the relative ranking based on a random 1-storm composite or 2-storm composite design was also presented for other monitoring sites (Pulgas Pump Station-South, Sunnyvale East Channel, North Richmond Pump Station, San Leandro Creek, Zone 4 Line A, and Lower Marsh Creek). This analysis showed that the potential for a false negative could occur due to a low number of sampled storms, especially in smaller and more urbanized watersheds where transport events can be more acute due to lack of channel storage. The analysis further highlighted the trade-off between gathering information at fewer sites with more certainty versus at more sites with less certainty. Based on these analyses, the SPLWG recommended a 1-storm composite per site design with allowances that a site could be revisited if the measured concentrations were lower than expected, either because a low-intensity storm was sampled or other information suggested that potential sources exist.

In addition to composite sampling, a pilot study was designed and implemented to test remote suspended sediment samplers based on enhanced water column settling. Four sampler types were considered: the single-stage siphon sampler, the CLAM sampler, the Hamlin sampler, and the Walling Tube. The SPLWG recommended the single-stage siphon sampler be dropped because it allowed for collection of only a single stormwater sample at a single time point, and therefore offers no advantage over manual sampling but requires more effort and expense to deploy. The CLAM sampler was also dropped as it had limitations affecting the interpretation of the data; primarily its inability to estimate the volume of water passing through the filters and the lack of performance tests in high turbidity environments. As a result, the remaining two samplers (Hamlin sampler and Walling Tube) were selected for the pilot study as previous studies showed the promise of using these devices in similar systems (Phillips et al., 2000; Lubliner, 2012). The SPLWG recommended piloting these samplers at 12 locations¹⁶ where manual water composites would be collected in parallel to test the comparability between sampling methods.

¹⁶ Note that so far due to climatic constraints, only 9 and 7 locations have been sampled with the Hamlin and Walling samplers, respectively. Additional samples using the Walling sampler are planned for WY 2018.

Appendix C – Quality assurance

The sections below report quality assurance reviews on WYs 2015-18 data only. The data were reviewed using the quality assurance program plan (QAPP) developed for the San Francisco Bay Regional Monitoring Program for Water Quality (Yee et al., 2017). That QAPP describes how RMP data are reviewed for possible issues with hold times, sensitivity, blank contamination, precision, accuracy, comparison of dissolved and total phases, magnitude of concentrations versus concentrations from previous years, other similar local studies or studies described from elsewhere in peer-reviewed literature and PCB (or other organics) fingerprinting. Data handling procedures and acceptance criteria can differ among monitoring protocols, however, for the RMP the underlying data were never discarded. Because the results for “censored” data were maintained, the effects of applying different QA protocols can be assessed by a future analyst if desired.

Suspended Sediment Concentration and Particle Size Distribution

In WY 2015, the SSC and particle size distribution (PSD)¹⁷ data from USGS-PCMISC were acceptable, aside from failing hold-time targets. SSC samples were all analyzed outside of hold time (between 9 and 93 days after collection, exceeding the 7-day hold time specified in the RMP QAPP); hold times are not specified in the RMP QAPP for PSD. Minimum detection limits (MDLs) were generally sufficient, with <20% non-detects (NDs) reported for SSC and the more abundant Clay and Silt fractions. Extensive NDs (>50%) were generally reported for the sand fractions starting as fine as 0.125 mm and larger, with 100% NDs for the coarsest (Granule + Pebble/2.0 to <64 mm) fraction. Method blanks and spiked samples are not typically reported for SSC and PSD. Blind field replicates were used to evaluate precision in the absence of any other replicates. The relative standard deviation (RSD) for two field blind replicates of SSC were well below the 10% target. Particle size fractions had average RSDs ranging from 12% for Silt to 62% for Fine Sand. Although some individual fractions had average relative percent difference (RPD) or RSDs >40%, suspended sediments in runoff (and particle size distributions within that SSC) can be highly variable, even when collected by minutes, so results were flagged as estimated values rather than rejected. Fines (clay and silt) represented the largest proportion (~89% average) of the mass.

In 2016 samples, SSC and PSD was analyzed beyond the specified 7-day hold time (between 20 and 93 days after collection) and qualified for holding-time violation but not censored. No hold time is specified for grain-size analysis. Method detection limits were sufficient to have some reportable results for nearly all the finer fractions, with extensive NDs (> 50%) for many of the coarser fractions. No method blanks or spiked samples were analyzed/reported, common with SSC and PSD. Precision for PSD could not be evaluated as no replicates were analyzed for 2016. Precision of the SSC analysis was evaluated using the field blind replicates and the average RSD of 2.12% was well within the 10% target Method Quality Objective (MQO). PSD results were similar to other years, dominated by around 80% Fines.

¹⁷ Particle size data were captured for % Clay (<0.0039 mm), % Silt (0.0039 to <0.0625 mm), % V. Fine Sand (0.0625 to <0.125 mm), % Fine Sand (0.125 to <0.25 mm), % Medium Sand (0.25 to <0.5 mm), % Coarse Sand (0.5 to <1.0 mm), % V. Coarse Sand (1.0 to <2.0 mm), and % Granule + Pebble (>2.0 mm).

Average SSC for whole-water samples (excluding those from passive samplers) was in a reasonable range of a few hundred mg/L.

In 2017, method detection limits were sufficient to have at least one reportable result for all analyte/fraction combinations. Extensive non-detects (NDs > 50%) were reported for only Granule + Pebble/2.0 to <64 mm (90%). The analyte/fraction combinations Silt/0.0039 to <0.0625 mm; Sand/Medium 0.25 to <0.5 mm; Sand/Coarse 0.5 to <1.0 mm; Sand/V. Coarse 1.0 to <2.0 mm all had 20% (2 out of 10) non-detects. No method blanks were analyzed for grain size analysis. SSC was found in one of the five method blanks at a concentration of 1 mg/L. The average SSC concentration for the 3 method blanks in that batch was 0.33 mg/L < than the average method blank method detection limit of 0.5 mg/L. No blank contamination qualifiers were added. No spiked samples were analyzed/reported. Precision for grain size could not be evaluated as there was insufficient amount of sample for analysis of the field blind replicate. Precision of the SSC analysis was examined using the field blind replicates with the average RSD of 29.24% being well above the 10% target MQO, therefore they were flagged with the non-censoring qualifier "VIL" as an indication of possible uncertainty in precision.

In WY 2015, the SSC and particle size distribution (PSD)¹⁸ data from USGS-PCMSC were acceptable, aside from failing hold-time targets. SSC samples were all analyzed outside of hold time (between 25 and 62 days after collection, exceeding the 7-day hold time specified in the RMP QAPP); hold times are not specified in the RMP QAPP for PSD. Minimum detection limits (MDLs) were generally sufficient, with zero non-detects (NDs) reported for SSC and the more abundant Clay and Silt fractions. Extensive NDs (>50%) were generally reported for the sand fractions starting as fine as 0.125 mm and larger, with 100% NDs for the coarsest (Granule + Pebble/2.0 to <64 mm) fraction. Method blanks and spiked samples are not typically reported for SSC and PSD. Blind field replicates were used to evaluate precision in the absence of any other replicates. The relative standard deviation (RSD) for the field blind replicate of SSC was 8.22%, below the 10% target. Particle size fractions had average RSDs ranging from 10.6% - 10.7% for Fine, Clay and Silt fractions.

Organic Carbon in Water

Reported TOC and DOC data from EBMUD and ALS were acceptable. In 2015, TOC samples were field acidified on collection, DOC samples were field or lab filtered as soon as practical (usually within a day) and acidified after, so were generally within the recommended 24-hour holding time. MDLs were sufficient with no NDs reported for any field samples. TOC was detected in only one method blank (0.026 mg/L), just above the MDL (0.024 mg/L), but the average blank concentration (0.013 mg/L) was still below the MDL, so results were not flagged. Matrix spike samples were used to evaluate accuracy, although many samples were not spiked high enough for adequate evaluation (must be at least two times the parent sample concentration). Recovery errors in the remaining DOC matrix spikes were all below the 10% target MQO. TOC errors in WY 2015 averaged 14%, above the 10% MQO, and TOC was therefore qualified but not censored. Laboratory replicate samples evaluated for precision had an

¹⁸ Particle size data were captured for % Clay (<0.0039 mm), % Silt (0.0039 to <0.0625 mm), % V. Fine Sand (0.0625 to <0.125 mm), % Fine Sand (0.125 to <0.25 mm), % Medium Sand (0.25 to <0.5 mm), % Coarse Sand (0.5 to <1.0 mm), % V. Coarse Sand (1.0 to <2.0 mm), and % Granule + Pebble (>2.0 mm).

WYs 2015 through 2018 POC Reconnaissance Monitoring

average RSD of <2% for DOC and TOC, and 5.5% for POC, within the 10% target MQO. RSDs for field replicates were also within the target MQO of 10% (3% for DOC and 9% for TOC), so no precision qualifiers were needed.

POC and DOC were also analyzed by ALS in 2016. One POC sample was flagged for a holding time of 104 days (past the specified 100 days). All OC analytes were detected in all field samples and were not detected in method blanks, but DOC was detected in filter blanks at 1.6% of the average field sample and 5% of the lowest field sample. The average recovery error was 4% for POC evaluated in LCS samples, and 2% for DOC and TOC in matrix spikes, within the target MQO of 10%. Precision on POC LCS replicates averaged 5.5% RSD, and 2% for DOC and TOC field sample lab replicates, well within the 10% target MQO. No recovery or precision qualifiers were needed. The average 2016 POC was about three times higher than 2014 results. DOC and TOC were 55% and 117% of 2016 results, respectively.

In 2017, method detection limits were sufficient with no non-detects (NDs) reported except for method blanks. DOC and TOC were found in one method blank in one lab batch for both analytes. Four DOC and 8 TOC results were flagged with the non-censoring qualifier "VIP". TOC was found in the field blank and its three lab replicates at an average concentration of 0.5375 mg/L which is 8.6% of the average concentration found in the field and lab replicate samples (6.24 mg/L). Accuracy was evaluated using the matrix spikes except for POC which was evaluated using the laboratory control samples. The average %error was less than the target MQO of 10% for all three analytes; DOC (5.2%), POC (1.96%), and TOC (6.5%). The laboratory control samples were also examined for DOC and TOC and the average %error was once again less than the 10% target MQO. No qualifying flags were needed. Precision was evaluated using the lab replicates with the average RSD being well below the 10% target MQO for all three analytes; DOC (1.85%), POC (0.97%), and TOC (1.89%). The average RSD for TOC including the blind field replicate and its lab replicates was 2.32% less than the target MQO of 10%. The laboratory control sample replicates were examined and the average RSD was once again well below the 10% target MQO. No qualifying flags were added.

In WY 2018, all TOC samples were censored. Accuracy was evaluated using the matrix spikes. The average %error for TOC in the matrix spikes of 47.68% (average recovery 147.68%) was above the 10% target MQO.

PCBs in Water and Sediment

PCBs samples were analyzed for 40 PCB congeners (PCB-8, PCB-18, PCB-28, PCB-31, PCB-33, PCB-44, PCB-49, PCB-52, PCB-56, PCB-60, PCB-66, PCB-70, PCB-74, PCB-87, PCB-95, PCB-97, PCB-99, PCB-101, PCB-105, PCB-110, PCB-118, PCB-128, PCB-132, PCB-138, PCB-141, PCB-149, PCB-151, PCB-153, PCB-156, PCB-158, PCB-170, PCB-174, PCB-177, PCB-180, PCB-183, PCB-187, PCB-194, PCB-195, PCB-201, PCB-203). Water (whole water and dissolved) and sediment (separately analyzed particulate) PCB data from AXYS were acceptable. EPA 1668 methods for PCBs recommend analysis within a year, and all samples were analyzed well within that time (maximum 64 days). MDLs were sufficient with no NDs reported for any of the PCB congeners measured. Some blank contamination was detected in method

WYs 2015 through 2018 POC Reconnaissance Monitoring

blanks for about 20 of the more abundant congeners, with only two PCB 008 field sample results censored for blank contamination exceeding one-third the concentration of PCB 008 in those field samples. Many of the same congeners detected in the method blank also were detected in the field blank, but at concentrations <1% the average measured in the field samples and (per RMP data quality guidelines) always less than one-third the lowest measured field concentration in the batch. Three target analytes (part of the "RMP 40 congeners"), PCBs 105, 118, and 156, and numerous other congeners were reported in laboratory control samples (LCS) to evaluate accuracy, with good recovery (average error on target compounds always <16%, well within the target MQO of 35%). A laboratory control material (modified NIST 1493) was also reported, with average error 22% or better for all congeners. Average RSDs for congeners in the field replicate were all <18%, within the MQO target of 35%, and LCS RSDs were ~2% or better. PCB concentrations have not been analyzed in remote sediment sampler sediments for previous POC studies, so no inter-annual comparisons could be made. PCBs in water samples were similar to those measured in previous years (2012-2014), ranging from 0.25 to 3 times previous averages, depending on the congener. Ratios of congeners generally followed expected abundances in the environment.

AXYS analyzed PCBs in dissolved, particulate, and total fraction water samples for 2016. Numerous congeners had several NDs, but extensive NDs (>50%) were reported for only PCBs 099 and 201 (both 60% NDs). Some blank contamination was detected in method blanks, with results for some congeners in field samples censored due to concentrations that were less than 3 times higher than the highest concentration measured in a blank. This was especially true for dissolved-fraction field samples with low concentrations. Accuracy was evaluated using the laboratory control samples. Again, only three of the PCBs (PCB 105, PCB 118, and PCB 156) reported in the field samples were included in LCS samples (most being non-target congeners), with average recovery errors for those of <10%, well below the target MQO of 35%. Precision on LCS and blind field replicates was also good, with average RSDs <5% and <15%, respectively, well below the 35% target MQO. Average PCB concentrations in total fraction water samples were similar to those measured to previous years, but total fraction samples were around 1% of those measured in 2015, possibly due to differences in the stations sampled.

AXYS also analyzed PCBs in dissolved, particulate, and total fraction water samples for 2017. Numerous congeners had several NDs but none extensively. Some blank contamination was detected in method blanks, with results for some congeners in field samples censored due to concentrations that were less than 3 times higher than the highest concentration measured in a blank. This was especially true for dissolved-fraction field samples with low concentrations. Accuracy was evaluated using the laboratory control samples. Again, only three of the PCBs (PCB 105, PCB 118, and PCB 156) reported in the field samples were included in LCS samples (most being non-target congeners), with average recovery errors for those of <10%, well below the target MQO of 35%. Precision on LCS replicates was also good, with average RSDs <5%, well below the 35% target MQO.

In WY 2018, AXYS analyzed total water samples for PCBs (no samples for dissolved or particulate fractions were submitted for analysis). Method detection limits were acceptable with non-detects (NDs) reported for a single PCB 170 result (7.14%; 1 out of 14 PCB 170 results). PCB 008, PCB 018, PCB 028, PCB 031, PCB 033, PCB 044, PCB 049, PCB 052, PCB 056, PCB 066, PCB 070, PCB 087, PCB 095, PCB 099,

WYs 2015 through 2018 POC Reconnaissance Monitoring

PCB 101, PCB 105, PCB 110, PCB 118, PCB 138, PCB 149, PCB 151, and PCB 174 were found in at least one and often both method blanks at concentrations above the method detection limits. Two PCB 008 results (14.29%; 2 out of 14 results) were flagged with the censoring qualifier VRIP; other blank contaminated results were flagged by the laboratory and did not need to be censored. Contamination was found in the field blank for PCB 008, PCB 018, PCB 028, PCB 031, PCB 033, PCB 044, PCB 049, PCB 052, PCB 056, PCB 060, PCB 066, PCB 070, PCB 087, PCB 095, PCB 099, PCB 101, PCB 110, PCB 118, PCB 138, PCB 151, PCB 153, and PCB187 at concentrations generally less than 1% of the average concentrations found in the field samples (the only exception was PCB 008 which was found in the field blank at a concentration representing ~2% of the average field sample concentration). Accuracy was evaluated using the laboratory control samples (LCSs); the only spiked samples reported. PCB 105, PCB 118, and PCB 156 were the only target congeners included in the LCS samples with an average %error of 8.35%, 9.25%, and 13.63%, respectively, all well below the 35% target MQO. No qualifiers were needed. Precision was evaluated using the blind field replicates. The average RSD ranged from 0.10% to 17.99% for the 40 target PCB congeners; all below the target MQO of 35% target. Laboratory control sample replicates were examined, but not used in the evaluation. The respective RSD's for PCB 105, PCB 118, and PCB 156 were 11.07%, 12.25%, and 3.27%, respectively. No qualification was necessary.

Trace Elements in Water

Overall the 2015 water trace elements (As, Cd, Pb, Cu, Zn, Hg) data from Brooks Rand Labs (BRL) were acceptable. MDLs were sufficient with no NDs reported for any field samples. Arsenic was detected in one method blank, and mercury in four method blanks; the results were blank corrected, and blank variation was <MDL. No analytes were detected in the field blank. Recoveries in certified reference materials (CRMs) were good, averaging 2% error for mercury to 5% for zinc, all well below the target MQOs (35% for arsenic and mercury; 25% for all others). Matrix spike and LCS recovery errors all averaged below 10%, well within the accuracy MQOs. Precision was evaluated in laboratory replicates, except for mercury, which was evaluated in certified reference material replicates (no mercury lab replicates were analyzed). RSDs on lab replicates ranged from <1% for zinc to 4% for arsenic, well within target MQOs (35% for arsenic and mercury; 25% for all the other analytes). Mercury CRM replicate RSD was 1%, also well within the target MQO. Matrix spike and laboratory control sample replicates similarly had average RSDs well within their respective target MQOs. Even including the field heterogeneity from blind field replicates, precision MQOs were easily met. Average concentrations were up to 12 times higher than the average concentrations of 2012-2014 POC water samples, but whole water composite samples were in a similar range those measured in as previous years.

For 2016 the quality assurance for trace elements in water reported by Brooks Applied Lab (BRL's name post-merger) was good. Blank corrected results were reported for all elements (As, Cd, Ca, Cu, Hardness (as CaCO₃), Pb, Mg, Hg, Se, and Zn). MDLs were sufficient for the water samples with no NDs reported for Cd, Cu, Pb, Hg, and Zn. Around 20% NDs were reported for As, Ca, Hardness, and Mg, and 56% for Se. Mercury was detected in a filter blank, and in one of the three field blanks, but at concentrations <4% of the average in field samples and (per RMP data quality guidelines) always less than one-third the lowest measured field concentration in the batch. Accuracy on certified reference materials was good, with

WYs 2015 through 2018 POC Reconnaissance Monitoring

average %error for the CRMs ranging from 2 to 18%, well within target MQOs (25% for Cd, Ca, Cu, Pb, Mg, Zn; 35% for As, Hg, and Se). Recovery errors on matrix spike and LCS results on these compounds was also good, with the average errors all below 9%, well within target MQOs. The average error of 4.8% on a Hardness LCS was within the target MQO of 5%. Precision was evaluated for field sample replicates, except for Hg, where matrix spike replicates were used. Average RSDs were all < 8%, and all below their relevant target MQOs (5% for Hardness; 25% for Cd, Ca, Cu, Pb, Mg, Zn; 35% for As, Hg, and Se). Blind field replicates were also consistent, with average RSDs ranging from 1% to 17%, all within target MQOs. Precision on matrix spike and LCS replicates was also good. No qualifiers were added. Average concentrations in the 2016 water samples were in a similar range of POC samples from previous years (2003-2015), with averages ranging 0.1x to 2x previous years' averages.

In 2017, the data was overall good and all field samples were usable. Blank corrected results were reported for all elements (As, Cd, Ca, Cu, Hardness (as CaCO₃), Pb, Mg, Hg, Se, and Zn). MDLs were sufficient for the water samples with no NDs reported. The Hg was also not detected. Accuracy on certified reference materials was good, with average %error for the CRMs within 12%, well within target MQOs (25% for Cd, Ca, Cu, Pb, Mg, Zn; 35% for As, Hg, and Se). Recovery errors on matrix spike and LCS results on these compounds were also all within target MQOs. Precision was evaluated for field sample replicates. Average RSDs were all < 8%, and all below their relevant target MQOs (5% for Hardness; 25% for Cd, Ca, Cu, Pb, Mg, Zn; 35% for As, Hg, and Se).

In WY 2018, samples were only analyzed for mercury. Samples were all measured well within hold time. Method detection limits were acceptable as no non-detects (NDs) were reported for mercury. Mercury was not found in the method blanks at concentrations above the method detection limits. All method blank results were NDs. The single field blank contained mercury at a low concentration (0.00015 ug/L) equal to ~0.1% of the average mercury concentration measured in the field samples. Accuracy was evaluated using the matrix spikes. The average %error for mercury in the matrix spikes of 4% was well below the 35% target MQO. Laboratory control material samples were examined, but not used in the evaluation. The average %error of 6% was also well below the target MQO of 35%. No qualifiers were needed. Precision was evaluated using the lab replicates. The average RSD for Mercury was 3% well below the target MQO of 35% target (average RSD for lab replicates and field replicates combined was 6%). Matrix spike replicates were examined, but not used in the evaluation. The average RSD of 2% was also below the 35% target MQO. The laboratory control materials were not used because they had different though similar target values. No additional qualifiers were added.

Trace Elements in Sediment

A single sediment sample was obtained in 2015 from fractionating one Hamlin sampler and analyzing for As, Cd, Pb, Cu, Zn, and Hg concentration on sediment. Overall the data were acceptable. MDLs were sufficient with no NDs for any analytes in field samples. Arsenic was detected in one method blank (0.08 mg/kg dw) just above the MDL (0.06 mg/kg dw), but results were blank corrected and the blank standard deviation was less than the MDL so results were not blank flagged. All other analytes were not detected in method blanks. CRM recoveries showed average errors ranging from 1% for copper to 24%

WYs 2015 through 2018 POC Reconnaissance Monitoring

for mercury, all within their target MQOs (35% for arsenic and mercury; 25% for others). Matrix spike and LCS average recoveries were also within target MQOs when spiked at least 2 times the native concentrations. Laboratory replicate RSDs were good, averaging from <1% for zinc to 5% for arsenic, all well within the target MQOs (35% for arsenic and mercury; 25% for others). Matrix spike RSDs were all 5% or less, also well within target MQOs. Average results ranged from 1 to 14 times higher than the average concentrations for the RMP Status and Trend sediment samples (2009-2014). Results were reported for Mercury and Total Solids in one sediment sample analyzed in two laboratory batches. Other client samples (including lab replicates and Matrix Spike/Matrix Spike replicates), a certified reference material (CRM), and method blanks were also analyzed. Mercury results were reported blank corrected.

In 2016, a single sediment sample was obtained from a Hamlin sampler, which was analyzed for total Hg by BAL. MDLs were sufficient with no NDs reported, and no target analytes were detected in the method blanks. Accuracy for mercury was evaluated in a CRM sample (NRC MESS-4). The average recovery error for mercury was 13%, well within the target MQO of 35%. Precision was evaluated using the laboratory replicates of the other client samples concurrently analyzed by BAL. Average RSDs for Hg and Total Solids were 3% and 0.14%, respectively, well below the 35% target MQO. Other client sample matrix spike replicates also had RSDs well below the target MQO, so no qualifiers were needed for recovery or precision issues. The Hg concentration was 30% lower than the 2015 POC sediment sample.

Appendix D – Figures 7 and 10 Supplementary Info

Sample counts for data displayed in Figures 7 and 10 bar graphs. For samples with a count of 2 or more, the central tendency was used which was calculated as the sum of the pollutant water concentrations divided by the sum of the SSC data.

Catchment	Year Sampled	Discrete Grabs	Composite Samples	Number of Aliquots per composite sample
Belmont Creek	Prior to WY2015	4	0	NA
Borel Creek	Prior to WY2015	5	0	NA
Calabazas Creek	Prior to WY2015	5	0	NA
Ettie Street Pump Station	Prior to WY2015	4	0	NA
Glen Echo Creek	Prior to WY2015	4	0	NA
Guadalupe River at Foxworthy Road/ Almaden Expressway	Prior to WY2015	14 PCB; 46 Hg	0	NA
Guadalupe River at Hwy 101	Prior to WY2015	119 PCB; 261 Hg	0	NA
Lower Coyote Creek	Prior to WY2015	5 PCB; 6 Hg	0	NA
Lower Marsh Creek	Prior to WY2015	28 PCB; 31 Hg	0	NA
Lower Penitencia Creek	Prior to WY2015	4	0	NA
North Richmond Pump Station	Prior to WY2015	38	0	NA
Pulgas Pump Station-North	Prior to WY2015	4	0	NA
Pulgas Pump Station-South	Prior to WY2015	29 PCB; 26 Hg	0	NA
San Leandro Creek	Prior to WY2015	39 PCB; 38 Hg	0	NA
San Lorenzo Creek	Prior to WY2015	5 PCB; 6 Hg	0	NA
San Pedro Storm Drain	Prior to WY2015	0 PCB; 3 Hg	0	NA
San Tomas Creek	Prior to WY2015	5	0	NA
Santa Fe Channel	Prior to WY2015	5	0	NA
Stevens Creek	Prior to WY2015	6	0	NA
Sunnyvale East Channel	Prior to WY2015	42 PCB; 41 Hg	0	NA
Walnut Creek	Prior to WY2015	6 PCB; 5 Hg	0	NA
Zone 4 Line A	Prior to WY2015	69 PCB; 94 Hg	0	NA
Zone 5 Line M	Prior to WY2015	4	0	NA
Charcot Ave Storm Drain	WY2015	0	1	6
E. Gish Rd Storm Drain	WY2015	0	1	5
Gateway Ave Storm Drain	WY2015	0	1	6
Line 3A-M-1 at Industrial Pump Station	WY2015	0	1	6
Line 4-B-1	WY2015	0	1	5
Line 9-D	WY2015	0	1	8
Line-3A-M at 3A-D	WY2015	0	1	5
Line4-E	WY2015	0	1	6
Lower Penitencia Creek	WY2015	0	1	7
Meeker Slough	WY2015	0	1	6
Oddstad Pump Station	WY2015	0	1	6
Outfall to Lower Silver Creek	WY2015	0	1	5
Ridder Park Dr Storm Drain	WY2015	0	1	5
Rock Springs Dr Storm Drain	WY2015	0	1	5
Runnymede Ditch	WY2015	0	1	6
Seabord Ave Storm Drain SC-050GAC580	WY2015	0	1	5
Seabord Ave Storm Drain SC-050GAC600	WY2015	0	1	5
South Linden Pump Station	WY2015	0	1	5
Storm Drain near Cooley Landing	WY2015	0	1	6

WYs 2015 through 2018 POC Reconnaissance Monitoring

Catchment	Year Sampled	Discrete Grabs	Composite Samples	Number of Aliquots per composite sample
Veterans Pump Station	WY2015	0	1	5
Condensa St SD	WY2016	0	1	6
Duane Ct and Ave Triangle SD	WY2016	0	1	5
Duane Ct and Ave Triangle SD	WY2016	0	1	3
E Outfall to San Tomas at Scott Blvd	WY2016	0	1	6
Forbes Blvd Outfall	WY2016	0	1	5
Gull Dr Outfall	WY2016	0	1	5
Gull Dr SD	WY2016	0	1	5
Haig St SD	WY2016	0	1	6
Industrial Rd Ditch	WY2016	0	1	4
Lawrence & Central Expwys SD	WY2016	0	1	3
Line 13A at end of slough	WY2016	0	1	7
Line 9D1 PS at outfall to Line 9D	WY2016	0	1	8
Outfall at Gilman St.	WY2016	0	1	9
Taylor Way SD	WY2016	0	1	5
Tunnel Ave Ditch	WY2016	0	1	6
Valley Dr SD	WY2016	0	1	6
Victor Nelo PS Outfall	WY2016	0	1	9
Zone 12 Line A under Temescal Ck Park	WY2016	0	1	8
Line 12H at Coliseum Way	WY2017	0	1	3
Outfall to Colma Ck on service rd nr Littlefield Ave. (359)	WY2017	0	1	2
S Linden Ave SD (291)	WY2017	0	1	7
Austin Ck at Hwy 37	WY2017	0	1	6
Line 12I at Coliseum Way	WY2017	0	1	3
Kirker Ck at Pittsburg Antioch Hwy and Verne Roberts Cir	WY2017	0	1	4
Line 12M at Coliseum Way	WY2017	0	1	4
Line 12F below PG&E station	WY2017	0	1	3
Rosemary St SD 066GAC550C	WY2017	0	1	5
North Fourth St SD 066GAC550B	WY2017	0	1	5
Line 12K at Coliseum Entrance	WY2017	0	1	4
Colma Ck at S. Linden Blvd	WY2017	0	1	5
Line 12J at mouth to 12K	WY2017	0	1	3
S Spruce Ave SD at Mayfair Ave (296)	WY2017	0	1	8
Guadalupe River at Hwy 101	WY2017	0	0	7
Refugio Ck at Tsushima St	WY2017	0	1	6
Rodeo Creek at Seacliff Ct. Pedestrian Br.	WY2017	0	1	7
East Antioch nr Trembath	WY2017	0	1	6
Outfall at Gilman St.	WY2018	0	1	5
Zone 12 Line A at Shellmound	WY2018	0	1	6
Meeker Slough	WY2018	0	1	5
MeekerWest	WY2018	0	1	5
Little Bull Valley	WY2018	0	1	2
Kirker Ck at Pittsburg Antioch Hwy and Verne Roberts Cir	WY2018	0	1	5
Gull Dr Outfall	WY2018	0	1	6
Gull Dr SD	WY2018	0	1	5
GR outfall 066GAC850	WY2018	0	1	4
GR outfall 066GAC900	WY2018	0	1	4

Appendix 8

BASMAA RMC Five-Year Bioassessment Report

This page intentionally blank

BASMAA Regional Monitoring Coalition Five-Year Bioassessment Report

Water Years 2012 - 2016



Prepared for:

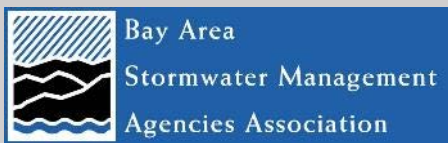

Prepared by:



March 2019

Table of Contents

Executive Summary.....	iv
1 Introduction	1
1.1 Background.....	1
1.2 Project Goal	1
1.3 Bioassessments Programs in California	2
1.4 Biostimulatory/Biointegrity Policy Development	3
2 Methods.....	5
2.1 Study Area	5
2.2 Survey Design and Sampling Sites.....	5
2.3 Sampling Protocols/Data Collection	6
2.4 Data Analyses	8
3 Results.....	14
3.1 Site Evaluation Results	14
3.2 Biological Condition of Bay Area Streams.....	16
3.3 Stressors Associated with Biological Condition	23
3.4 Trends.....	33
4 Findings and Next Steps	37
4.1 <i>What are the biological conditions of streams in the RMC Area?</i>	37
4.2 <i>What stressors are associated with biological conditions?</i>	39
4.3 <i>Are Biological Conditions Changing Over Time?</i>	40
4.4 Evaluation of Monitoring Design	41
4.5 Possible Next Steps for the RMC Bioassessment Monitoring	42
5 References.....	44

List of Tables

Table 1. Number of sites and stream length from the master draw in each post-stratification category. ... 6

Table 2. Biological condition indices, categories and thresholds..... 10

Table 3. Biological condition and stressor variable thresholds used for relative risk assessment. 12

Table 4. Number of sites per county in each site evaluation class. 14

Table 5. Summary statistics for the CSCI random forest model. Rank of importance of selected stressor variables are colored according to categories: physical habitat (green), land use (brown), and water quality (blue). The correlation coefficient (rho) for each stressor variable is also presented..... 23

Table 6. Summary statistics for the D18 random forest model. Rank of importance of selected stressor variables are colored according to categories: physical habitat (green), land use (brown), and water quality (blue). The correlation coefficient (rho) for each stressor variable is also presented..... 24

Table 7. Sites remaining in RMC sample frame before site evaluation in water year 2019..... 41

List of Figures

Figure 1. Distribution of CSCI scores at reference sites with thresholds and condition categories used to evaluate CSCI scores (from Rehn et al. 2015)..... 10

Figure 2. Plot of CSCI score and *chlorophyll a* concentration at RMC sites. 13

Figure 3. RMC sites evaluated by evaluation class. 15

Figure 4. Annual precipitation at San Francisco Airport (2000-2017)..... 16

Figure 5. Cumulative distribution function (CDF) of CSCI scores at all RMC sites and urban sites. 17

Figure 6. Cumulative distribution function (CDF) of D18 scores at all RMC sites and urban sites. 18

Figure 7. Cumulative distribution function (CDF) of S2 scores at all RMC sites and urban sites..... 18

Figure 8. Cumulative distribution functions of CSCI scores at RMC urban sites in each participating Bay Area County..... 19

Figure 9. Biological condition of streams in the RMC area based on CSCI scores. 20

Figure 10. CSCI scores for urban and non-urban sites in each County. Sample sizes for each county are included in each boxplot. 21

Figure 11. D18 scores for urban and non-urban sites in each County. Sample sizes for each county are included in each boxplot. 22

Figure 12. S2 scores for urban and non-urban sites in each County. Sample sizes for each county are included in each boxplot. 22

Figure 13. Relationship of CSCI scores to the Human Disturbance Index (HDI) stressor indicator. Red line indicates a reference condition cutoff of 1.5 (Ode et al. 2016)..... 26

Figure 14. Relationship of CSCI scores to the percentage of land area in a 5 km radius (km²) around the site that is impervious. 27

Figure 15. Relationship of CSCI score to the percent of substrate in the stream reach that was smaller than sand..... 28

Figure 16. Relationship of D18 score to chloride concentration (mg/L). Note the chloride concentration scale is displayed in log units. 29

Figure 17. Relationship of D18 score to specific conductivity (µS/cm)..... 30

Figure 18. Relationship of D18 score to the percent of substrate in the stream reach that was smaller than sand. 31

Figure 19. Relative risk of poor biological condition (i.e., scores in the lowest two CSCI condition categories) for sites that exceed stressor disturbance thresholds. 32

Figure 20. Distribution of CSCI scores during water years 2012-2016. NU = non-urban, U= urban 34

Figure 21. Distribution of D18 scores during water years 2012-2016. NU = non-urban, U= urban..... 34

Figure 22. Distribution of S2 scores during water years 2012-2016. NU = non-urban, U= urban 35

Figure 23. Relationship between median CSCI scores and accumulated annual rainfall in each County during water years 2012-2016. Includes urban and non-urban sites. 36

Executive Summary

Biological assessment (bioassessment) is an evaluation of the biological condition of a water body based on the organisms living within it. In 2009, the Bay Area Stormwater Management Agencies Association's (BASMAA) Regional Monitoring Coalition (RMC) developed a bioassessment monitoring program to answer management questions identified in the Municipal Regional Stormwater National Pollutant Discharge Elimination System (NPDES) Permit (referred to as the Municipal Regional Permit or MRP):

- *Are water quality objectives, both numeric and narrative, being met in local receiving waters, including creeks, rivers and tributaries?*
- *Are conditions in local receiving waters supportive or likely to be supportive of beneficial uses?*

Bioassessment data collected over the first five years of RMC monitoring (2012-2016) are included in this report. The RMC's monitoring design addresses these management questions on a regional (Bay Area) scale to monitoring results across the five participating Bay Area counties (Alameda, Contra Costa, San Mateo, Santa Clara and Solano). Three study questions, developed to assist with addressing the management questions described above, including:

- 1) What is the biological condition of perennial and non-perennial streams in the region?
- 2) What stressors are associated with poor condition?
- 3) Are conditions changing over time?

The findings of this study are intended to help stormwater programs better understand the current condition of these water bodies and identify stressors that are likely to pose the greatest risk to the health of streams in the Bay Area. The report evaluates the existing RMC monitoring design and identifies a range of potential options for revising the design (if desired) to better address the questions posed. These options are intended to provide considerations for discussion during the planning for reissuance of the Municipal Regional Permit, which is likely to be adopted in 2020 or 2021.

KEY FINDINGS

- **Most streams in the region are in poor biological condition.** The biological conditions of streams in the RMC area are assessed using two ecological indicators: benthic macroinvertebrates (BMIs) and algae. Results from 2012 through 2016 study period indicate that streams in the RMC area are generally in poor biological condition. Based on BMIs, over half (58%) of stream length was ranked in the lowest condition category of the California Stream Condition Index (CSCI). For algae indices (D18 and S2), stream conditions appear slightly less degraded, with approximately 40% of the streams ranked in lowest condition category. These findings should be interpreted with the understanding that the survey focused on urban stream conditions, and that these data represent current (baseline) conditions.
- **Poor biological conditions are strongly associated with physical habitat and landscape stressors.** The associations between biological indicators (CSCI and D18) and stressor data were evaluated using random forest and relative risk analyses. The study results showed that different biological indicators responded to different types of stressors. CSCI scores were strongly influenced by

physical habitat variables (e.g., level of human disturbance at a site) and land use factors (e.g., level of impervious surfaces near the site), while D18 scores were moderately influenced by water quality variables (e.g., dissolved oxygen and conductivity). Together, BMI and algae indices can be used to assess the overall biological condition of water bodies and potentially identify the causes of poor (or good) conditions. In general, CSCI scores at urban sites were consistently low, indicating that degraded physical habitat conditions common in urban settings are impacting biological conditions in streams. In contrast, D18 scores at urban sites were more variable, indicating that healthy diatom (algae) assemblages can occur at sites with poor physical habitat, which may provide valuable information about the overall water quality conditions in urban streams.

- **No changes in biological conditions are evident over the 5-year survey.** The short time frame of the survey (five years) limited the ability to detect trends. The variability in biological condition observed over the five years of the current analysis may have been associated with annual variation in precipitation, which included drought conditions during the first four years of the survey. A longer time period may be needed to detect trends in biological condition at a regional scale.
- **Baseline biological assessment data can assist Bay Area stormwater managers in evaluating the long-term effectiveness of ongoing or planned management actions.** Baseline bioassessment monitoring data collected by the RMC provides valuable information about the current status of aquatic life uses in the Bay Area and how RMC streams compare to other regions in the State of California. The baseline dataset provides context for potential future biological integrity policies being developed by the State Water Resources Control Board (State Water Board) and serves as a foundation for evaluating on-going and future watershed management actions that attempt to reduce the impacts of urbanization on creeks and channels. Future creek status monitoring may provide additional insight into the potential positive impacts of actions, such as green stormwater infrastructure and creek restoration, that improve water quality and address other needs of aquatic life uses in urban creeks.
- **The RMC monitoring design provides estimates for overall stream conditions in RMC area and urban stream conditions for each county.** Because participating municipalities are primarily concerned with stormwater runoff from urban areas, the RMC focused sampling efforts on urban sites (approximately 80%) over non-urban sites (approximately 20%). As a result, non-urban sites are under-represented in the dataset, resulting in lower overall biological condition scores than would be expected for a spatially balanced dataset. Depending on the goals for the RMC moving forward, consideration should be given to developing a new sample draw that establishes a new list of assessment sites that are weighted for specific land uses categories and Program areas of interest. Based on evaluation of data collected during the first five years of the survey, several options to revise the RMC Monitoring Design are presented in the report.

1 INTRODUCTION

1.1 BACKGROUND

The Bay Area Stormwater Management Agencies Association (BASMAA) Regional Monitoring Coalition (RMC) is a consortium of six San Francisco Bay Area municipal stormwater programs that joined together in 2010 to coordinate and oversee water quality monitoring required by the Municipal Regional Stormwater National Pollutant Discharge Elimination System (NPDES) Permit (referred to as the Municipal Regional Permit or “MRP”). The MRP was first adopted in 2009 (Order R2-2009-0074) by the San Francisco Bay Regional Water Quality Control Board (SFBRWQCB). The MRP was reissued in 2015 through Order R2-2015-1049. The 2009 and 2015 versions of the MRP are referred to as MRP 1.0 and MRP 2.0, respectively. Both versions of the MRP require bioassessment monitoring in accordance with Standard Operating Procedures (SOPs) established by the California Surface Water Ambient Monitoring Program (SWAMP), including sampling of benthic macroinvertebrates (BMIs), benthic algae (i.e., diatoms and soft algae), and water chemistry, and the characterization of physical habitat.

The MRP identifies two broad management questions that required bioassessment monitoring (and other creek status monitoring requirements) is intended to address:

- *Are water quality objectives, both numeric and narrative, being met in local receiving waters, including creeks, rivers and tributaries?*
- *Are conditions in local receiving waters supportive or likely to be supportive of beneficial uses?*

Consistent with the requirements of the MRP, the RMC developed a probabilistic monitoring design to address the management questions on a regional scale and compare monitoring results across stormwater programs. The probabilistic design is based on the Generalized Random Tessellation Stratified (GRTS) approach (Stevens and Olson 2004) for evaluating and selecting sampling stations in perennial and nonperennial streams. A power analysis estimated a minimum sample size of 30 sites to evaluate the condition of aquatic life within a confidence interval of approximately 12%. This was considered sufficient for decision-making in the RMC area. Under the MRP, each municipal Stormwater Program is required to assess a minimum number of stream/channel sites based on their relative population. As a result, the number of sites required each year varies by county: 20 sites for Santa Clara and Alameda counties and 10 sites for San Mateo and Contra Costa counties. Fairfield-Suisun and Vallejo are required to sample 8 and 4 sites, respectively, during each five-year period. In addition, the San Francisco Bay Regional Water Quality Control Board (SF Bay Water Board) collaborated with the RMC by monitoring additional sites in non-urban areas in each of the counties.

1.2 PROJECT GOAL

This goal of this project was to compile and evaluate bioassessment data collected over the first 5-years of bioassessment monitoring conducted by the RMC (2012 – 2016). The evaluation was designed to address three main questions, consistent with the overarching questions in the MRP:

- 1) What is the biological condition of perennial and non-perennial streams in the region?

- 2) What stressors are associated with poor condition?
- 3) Are conditions changing over time?

The findings of this report are intended to help stormwater programs better understand the current condition of these water bodies, prioritize stream reaches in need of protection or restoration, and identify stressors that are likely to pose the greatest risk to the health of streams in the Bay Area.

This report also provides an evaluation of the existing RMC monitoring design and identifies a range of potential options for revising the design (if desired) in anticipation of the next version of the MRP, which is likely to be adopted in 2020 or 2021. These options can inform the monitoring re-design process as part of a future BASMAA Regional Project.

This project was implemented by a Project Team comprised of EOA, Inc. and Applied Marine Sciences, Inc. (AMS) with technical review provided by the Southern California Coastal Water Research Project (SCCWRP). A BASMAA Project Management Team (PMT) consisting of representatives from BASMAA stormwater programs and municipalities provided oversight and guidance to the Project Team.

Sections of this report are organized according to the following topics:

- **Section 1.0** – Introduction including summary of other Regional Monitoring Programs using biological assessments, development of State policies that are relevant to bioassessment data collection, and description of the goals for this report;
- **Section 2.0** – Methods including monitoring survey design, site evaluation procedures, field sampling and data analyses;
- **Section 3.0** – Results summarizing biological conditions, stressor association with conditions, and trends;
- **Section 4.0** – Discussion organized by the management questions and goals; and
- **Section 5.0** – Conclusions and recommendations.

1.3 BIOASSESSMENTS PROGRAMS IN CALIFORNIA

Bioassessment programs are currently implemented on a statewide and regional basis in California. The RMC's monitoring design is consistent with the design used by the statewide Perennial Streams Assessment (PSA) program and is specifically intended to allow for future integration of data between the two monitoring programs. The RMC has also integrated lessons learned from the Stormwater Monitoring Coalition (SMC), which spearheads a similar collaborative monitoring effort in Southern California, in the development of alternatives for potential re-design of the RMC monitoring survey described at the end of this report.

Since 2000, the State of California has conducted probability surveys of its perennial streams and rivers with a focus on biological endpoints. These surveys are managed collectively by the Surface Water Ambient Monitoring Program (SWAMP) under its PSA program. The PSA collects samples for biological indicators (BMIs and algae), chemical constituents (nutrients, major ions, etc.), and physical habitat assessments for both in-stream and riparian corridor conditions. As of 2012, over 1300 unique perennial

stream sites have been monitored by PSA and its partner programs.¹ In 2015, the PSA developed a management memorandum summarizing biological conditions (based on California Stream Condition Index score) and associated stressor data collected at probabilistic sites over a 13-year time period (2000 – 2012) (SWRCB 2015).

The SMC, a coalition of multiple state, federal, and local agencies, initiated a regional monitoring program in 2009. The SMC uses multiple biological indicators to assess ecological health of streams, including BMIs, benthic algae (diatoms and soft algae) and riparian wetland condition. The SMC also collects water chemistry, water column toxicity, and physical habitat data to evaluate potential stressors to biological health. During the first five years of the program (2009 to 2013), the SMC monitored more than 500 probabilistic sites in 15 major watersheds in California’s South Coast region, with a focus on perennial streams (Mazor 2015). Evolution of those data suggested that few perennial, wadeable streams in the SMC study area are in good biological condition (Mazor 2015a). Recognizing that perennial streams account for only 25% of stream-miles in the region, in 2015, the SMC expanded its monitoring program to include nonperennial streams, which account for approximately 59% of stream-miles (Mazor 2015b). The SMC program also focused about 30% of the monitoring effort towards revisiting probabilistic sites to provide an estimate of change in condition (Mazor 2015b). The next iteration of the SMC monitoring program will likely include a larger focus on trends monitoring (Rafael Mazor, SCCWRP, personal communication, 2018).

1.4 BIOSTIMULATORY/BIOINTEGRITY POLICY DEVELOPMENT

Bioassessment monitoring conducted by the RMC not only provides information about the condition of aquatic life uses in Bay Area streams and how they compare to other regions (i.e., SMC), it also generates a significant baseline dataset that provides context for potential future biological integrity and biostimulatory policies that are currently under development by the State Water Resources Control Board (State Water Board). The biostimulatory policy will likely develop water quality objectives for biostimulatory substances (e.g., nutrients) along with an implementation program as an amendment to the Water Quality Control Plan for Inland Surface Water, Enclosed Bays and Estuaries of California (ISWEBE Plan).² The biostimulatory substances policy may include a numeric and/or narrative objective(s) that will be applicable to streams in California. The State Water Board plans is expected to establish the implementation plan for the biostimulatory substances policy in three phases, with each phase including a plan that would be unique for each of the three different water body types. The first phase of the Biostimulatory Amendment would be applicable to wadeable streams.

The biostimulatory policy will also include a water quality control policy (i.e., Biointegrity Policy) to establish and implement biological condition assessment methods, scoring tools, and targets aimed at protecting the biological integrity in wadeable streams. The policy will utilize a multi-indicator approach that includes the California Stream Condition Index (CSCI) for benthic macroinvertebrates and statewide

¹ The Stormwater Monitoring Coalition has collected a majority of samples at probabilistic sites in Coastal Southern California watersheds and the US Forest Service has collected PSA-comparable data from sites in National Forests of the Sierra Nevada.

² Information obtained from: https://www.waterboards.ca.gov/water_issues/programs/biostimulatory_substances_biointegrity

algal stream condition index (ACSI), which is currently under development. The State Water Board's plan is to establish "assessment endpoints" as primary lines of evidence to assess beneficial use support in wadeable streams. These endpoints may be used to establish default nutrient objectives or thresholds for California streams, with potential option to refine the thresholds under a "watershed approach."

The State Water Board's biostimulatory/biointegrity project has been delayed due to several unresolved policy issues that need to be addressed prior to development of the policy, including³:

- 1) Consideration of channels in highly developed landscapes (i.e., where assessment endpoints may not be achieved);
- 2) Identify Beneficial Uses;
- 3) Relationship between established biological assessment endpoints and nutrient endpoints; and
- 4) Define process for coordinated watershed approach.

The State Water Board is currently planning to develop draft policy options to present to Stakeholder Advisory and Regulatory Groups in 2019.

³ Information obtained from presentation by Jessie Maxfield, California State Water Board, given at the 2017 California Aquatic Bioassessment Workgroup conference in Davis, California.

2 METHODS

2.1 STUDY AREA

The study area for RMC creek status monitoring consists of the perennial and non-perennial streams, channels and rivers within the portions of the five participating counties (San Mateo, Santa Clara, Alameda, Contra Costa, Solano) that overlap with the San Francisco Bay Regional Water Quality Control Board (Region 2) boundary, and the eastern portion of Contra Costa County that drains to the Central Valley region (Region 5). The RMC creek status sample frame consists of the urban and non-urban portions of the stream network flowing through the RMC area. The source dataset used to create the sample frame was the 1:100,000 National Hydrography Dataset (NHD).

2.2 SURVEY DESIGN AND SAMPLING SITES

Creek status monitoring sites were selected based on a probabilistic survey design consisting of a master draw of 5,740 sites (approximately one site for every stream kilometer in the sample frame). The selection procedure employed the U.S. EPA's Generalized Random Tessellation Stratified (GRTS) survey design methodology (Stevens and Olson, 2004). The GRTS approach generated a spatially-balanced distribution of sites covering the majority of the San Francisco Bay Area. It should be noted that the sample draw of 5,740 sites did not account for land use designations or other emphases (i.e., County) and therefore, the master draw of sample sites was weighted towards commonly occurring conditions (i.e., non-urban sites), with less common conditions (i.e., reference and urban sites) being less represented due to their lower relative abundance in the sample frame.

The RMC sampling design targeted the population of accessible streams with flow conditions suitable for sampling (i.e., adequate flow during spring index period). A random set of potential monitoring sites (i.e., the master draw) was established, with each site having an equal, non-zero weight, proportional to the inverse of its selection probability. Thus, all sites were assumed to have an equal probability of selection throughout the sample frame. The weights represent the amount of stream length encompassed by each site in the overall target population.

Once the master draw was established, the list of monitoring sites was separated into 19 categories to facilitate site evaluations and implement creek status monitoring, including bioassessment (Table 1). The following attributes were used to generate the categories:

- County (n=5): San Mateo, Santa Clara, Alameda, Contra Costa, Solano (source: California Department of Forestry and Fire, 2009);
- Water Quality Control Board Region (n=2): Region 2, Region 5 (source: San Francisco Regional Water Quality Control Board, undated);
- Land use Category (n = 4): Urban or nonurban in all counties, except Solano ('urban_V' and 'urban_FS' in Solano County). Urban land use was defined as a combination of US Census (2000) areas classified as urban, and areas within Census City boundaries. This definition of urban land use results in some relatively undeveloped areas and parks along the fringes of cities to be

classified as urban. Urban sites therefore represent a broad range of developed (i.e., impervious surface) conditions. Non-urban area was defined as all remaining area in the RMC boundary not classified as urban.

Table 1. Number of sites and stream length from the master draw in each post-stratification category.

County	Urban		Non-Urban		Total	
	Sites	Stream Length (km)	Sites	Stream Length (km)	Sites	Stream Length (km)
San Mateo	222	233.8	528	556.0	750	789.8
Santa Clara	542	570.8	1376	1449.1	1918	2019.8
Alameda	454	478.1	842	886.7	1296	1364.8
Contra Costa (Region 2)	587	618.2	363	382.3	845	889.9
Contra Costa (Region 5)			349	367.5	454	478.1
Solano (Vallejo)	12	12.6	386	406.5	477	502.3
Solano (Fairfield-Suisun)	79	83.2				
Overall Total					5740	6,044.7

To maintain a spatially-balanced pool of monitoring sites, sites were evaluated in the order that they appeared in the master draw list (with a few exceptions). Sites were evaluated for sampling using both desktop and field reconnaissance. Field crews attempted to locate a reach suitable for sampling within 300 m of the target coordinates. Sites without a suitable reach were rejected for sampling. Reasons for rejection included physical barriers, lack of flowing water, refusal or lack of response from landowners, unwadeable (i.e., >1 m deep for at least 50% of the reach) and inappropriate waterbody types (e.g., tidally influenced). Sites with temporary inaccessibility, unsafe/hazardous or permission issues (e.g., construction, lack of response from landowners) were re-evaluated for sampling in subsequent years. All program participants were instructed to use a standard set of codes to identify the reason behind exclusion of sites.

In contrast to the PSA and SMC regional monitoring designs, which targeted perennial streams, the RMC sampled both perennial and non-perennial streams. Additionally, at the outset, each countywide Program agreed they would attempt to assess up to 20% of their required sites in non-urban areas.

2.3 SAMPLING PROTOCOLS/DATA COLLECTION

Biological sample collection and processing was consistent with the BASMAA RMC Quality Assurance Project Plan (QAPP)⁴ (BASMAA 2016a) and Standard Operating Protocols (SOPs) (BASMAA 2016b) which

⁴ The RMC QAPP and SOP documents were initially developed in 2012 (Version 1.0), revised in 2013 (Version 2.0) and 2016 (Version 3.0)

were developed to be consistent with the current SWAMP Quality Assurance Program Plan (QAPrP) and SOPs. Bioassessments were conducted during the spring index period (approximately April 15 – June 30) with the goal to sample a minimum of 30 days after any significant storm (defined as at least 0.5-inch of rainfall within a 24-hour period). A 30-day grace period allows diatom and soft algae communities to recover from peak flows that may scour benthic algae from the bottom of the stream channel.

2.3.1 Biological Indicators

Each monitoring site consisted of an approximately 150-meter stream reach that was divided into 11 equidistant transects placed perpendicular to the direction of flow. Benthic macroinvertebrate (BMI) and algae (i.e., diatom and soft algae) samples were collected at each transect using the Reach-wide Benthos (RWB) method described in Ode et al. (2016). The algae composite sample was also used to collect chlorophyll a and ash free dry mass (AFDM) samples following methods described in Ode et al. (2016).

Biological samples were sent to laboratories for analysis. The laboratory analytical methods used for BMIs followed Woodward et al. (2012), using the Southwest Association of Freshwater Invertebrate Taxonomists (SAFIT) Level 1a Standard Taxonomic Level of Effort, with the additional effort of identifying chironomids (midges) to subfamily/tribe instead of family (Chironomidae). Soft algae and diatom samples were analyzed following SWAMP protocols (Stancheva et al. 2015). The taxonomic resolution for all data was standardized to the SWAMP master taxonomic list.

2.3.2 Physical Habitat

Both quantitative and qualitative measurements of physical habitat structure were taken at each of the 11 transects and 10 inter-transects at each monitoring site. At the outset of the monitoring program in 2012, Physical habitat measurements followed procedures defined in the “BASIC” level of effort (Ode 2007), with the following exceptions as defined in the “FULL level of effort: stream depth and pebble count + coarse particulate organic matter (CPOM), cobble embeddedness, and discharge measurements. In 2016, the entire “FULL” level of effort for the characterization of physical habitat described in Ode et al. (2016) was adopted, consistent with the reissued MRP 2.0 (SFBRWQCB 2015). Physical habitat measurements include channel morphology (e.g., channel width and depth), habitat features (e.g., substrate size, algal cover, flow types, and in-stream habitat diversity) and human disturbance in the riparian zone (e.g., presence of buildings, roads, vegetation management). In addition, a qualitative Physical Habitat Assessment (PHAB) score was assessed for the entire bioassessment reach. The PHAB score is composed of three characteristics for the reach, including channel alteration, epifaunal substrate, and sediment deposition. Each attribute is individually scored on a scale of 0 to 20, with a score of 20 representing good condition.

2.3.3 Water Quality

Immediately prior to biological and physical habitat data collection, general water quality parameters (dissolved oxygen, pH, specific conductance and temperature) were measured at each site, at or near the centroid of the stream flow using pre-calibrated multi-parameter probes. In addition, water samples were collected for nutrients and conventional analytes analysis using the Standard Grab Sample Collection Method as described in SOP FS-2 (BASMAA 2016b).

2.3.4 Stressor Variables

Physical habitat, land-use, and water quality data were compiled and evaluated as potential stressor variables for biological condition. Land-use variables were calculated in GIS by overlaying the drainage area for sample locations with land use and road data. The variables included percent urbanization, percent impervious, total number of road crossings and road density at three different spatial scales (1 km, 5 km and entire watershed).

Physical habitat metrics were calculated using the SWAMP Bioassessment Reporting Module (SWAMP RM). The SWAMP RM output includes calculations based on parameters that are measured using EPA's Environmental Monitoring and Assessment Program (EMAP) for freshwater wadeable streams (Kaufmann et al. 1999), as well as parameters collected under the SWAMP protocol (Marco Sigala, personal communication, 2017). The RM produces a total of 176 different metrics based on data collected using the SWAMP "FULL" habitat protocol. Ten of the best performing metrics (Andy Rehn, CDFW, personal communication) were selected based on best professional judgment from the SWAMP RM output to analyze physical habitat data collected by the RMC.

General water quality (e.g., DO, SpCond) and chemistry (e.g., nitrate and phosphorus) data collected at the bioassessment sites were also included. Some of the water chemistry variables were calculated from the analytes that were measured. These include Total Nitrogen (sum of Nitrate, Nitrite and Total Kjeldahl Nitrogen) and Unionized Ammonia (calculated using pH and temperature).

2.3.5 Rainfall Data

For evaluation of trends, a representative rainfall dataset was collated for San Mateo, Santa Clara, Contra Costa, and Alameda counties. The total accumulated rainfall in each water year during the period of 2012-2016 was calculated. The rainfall dataset assembled was derived from: San Jose Airport (Santa Clara), San Francisco Airport (San Mateo), Oakland Airport (Alameda), and Walnut Creek (Contra Costa).

2.4 DATA ANALYSES

All statistical, tabular, and graphical analyses were conducted in R Studio, running R version 3.4.3 (R Core Team 2016). For analyses involving water quality data, censored results (i.e., below the method detection limit) were substituted with 50% of the method detection limit (MDL). Generally, analytical sensitivity was good, with only three variables having > 30% non-detects (Suspended Sediment Concentration, Nitrite, Ammonia). To facilitate use of the data for random forest and relative risk analyses, missing values were subject to an imputation method to fill in data gaps. Seven variables were found to have missing values. Three of these, Suspended Sediment Concentration (SSC), Dissolved Organic Carbon (DOC), and Alkalinity⁵, consisted of more than 50 missing values, and were excluded from further analysis. The remaining four variables (Silica, Ash Free Dry Mass, Chlorophyll a, Nitrate) were subject to imputation using the R-package *mice* (van Buuren and Groothuis-Oudshoorn, 2011). In this method, replacement values were randomly selected from the distribution of observed data. Overall, fewer than 25 values were

⁵ Suspended Sediment Concentration (SSC), Dissolved Organic Carbon (DOC) and alkalinity were not monitored in 2016, due to the removal of these parameters in Provision C.8.c of the reissued MRP.

imputed for any variable (Silica, n = 24; AFDM, n = 4; Nitrate, n = 1; Chl a, n = 1), and thus their influence on the analysis is assumed to be minor.

2.4.1 Biological Condition Indices

The California Stream Condition Index (CSCI) was developed by the State Water Board as a standardized measure of benthic macroinvertebrate assemblage condition in perennial wadeable rivers and streams. The CSCI was developed using a large reference data set representing the range of natural conditions in California (Ode et al. 2016). The CSCI tool (Mazor et al. 2016) translates BMI data into an overall measure of stream health by combining two types of indices: 1) ratio of observed-to-expected taxa (O/E) (used as a measure of taxonomic completeness), and 2) a predictive multi-metric index (pMMI) for reference conditions (used as a measure of ecological structure and function). The CSCI score is computed as the average of the sum of O/E and pMMI.

The CSCI scoring tool was used to assess BMI data collected at both perennial and non-perennial sites in the RMC area. The CSCI scores for RMC sites should be interpreted with caution, as the CSCI tool has not been fully validated at non-perennial sites. Preliminary analyses suggest that the CSCI is valid in certain types of nonperennial streams in southern California, but its validity in nonperennial streams in other regions, such as the Bay Area, remains unknown.

The algae data were analyzed using algal indices of biological integrity (IBIs) that were developed for streams in Southern California (Fetscher 2014). These include a soft algae index (S2), diatom index (D18) and soft algae-diatom hybrid index (H20). The algal indices were calculated using the SWAMP Algae Reporting Module (Algae RM). The interpretation of algae data collected in San Francisco Bay area using IBIs developed in Southern California (SoCal) should be considered preliminary. The State Board and SCCWRP are currently developing and testing a statewide index using benthic algae data as a measure of biological condition for streams in California. The statewide Algae Stream Condition Indices (ASCIs) were not available at the time this project was conducted, but are expected to be available in late 2018 (personal communication, Jessie Maxfield, SWRCB).

2.4.2 Biological Indicator Thresholds

Existing thresholds for biological indicator scores (CSCI, D18, S2) defined in Mazor (2015) were used to evaluate bioassessment data compiled and analyzed in this report (Table 2, Figure 1). The thresholds for each index were based on the distribution of scores for data collected at reference calibration sites in California (BMI) or in Southern California (algae). Four condition categories are defined by these thresholds: “likely intact” (greater than 30th percentile of calibration reference site scores); “possibly altered” (between the 10th and the 30th percentiles); “likely altered” (between the 1st and 10th percentiles); and “very likely altered” (less than the 1st percentile). The probability-based approach to develop the threshold classes was consistent across indices, allowing comparison for all indicators across sites.

The performance of CSCI on a statewide basis is the subject of ongoing review by the State Water Board. In the current MRP, the SF Bay Water Board defined a CSCI score of 0.795 as a threshold for identifying sites with degraded biological condition that should be considered candidates for Stressor Source Identification (SSID) projects. No MRP threshold has been established for any of the algae indices.

Table 2. Biological condition indices, categories and thresholds.

Index	Likely Intact	Possibly Altered	Likely Altered	Very Likely Altered
<i>Benthic Macroinvertebrates (BMI)</i>				
CSCI Score	≥ 0.92	≥ 0.79 to < 0.92	≥ 0.63 to < 0.79	< 0.63
<i>Benthic Algae</i>				
S2 Score	≥ 60	≥ 47 to < 60	≥ 29 to < 47	< 29
D18 Score	≥ 72	≥ 62 to < 72	≥ 49 to < 62	< 49

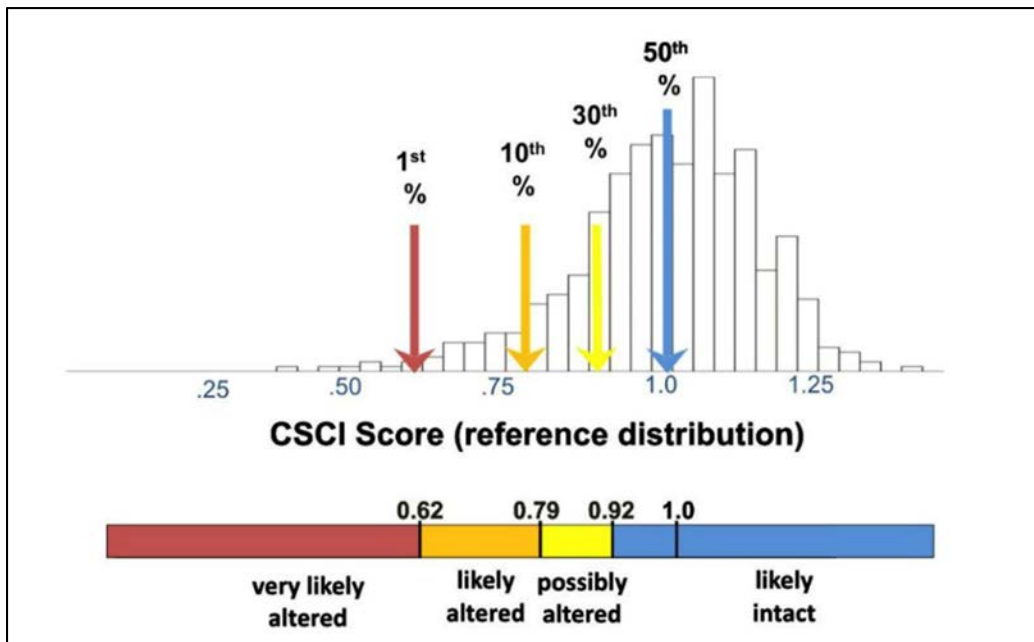

Figure 1. Distribution of CSCI scores at reference sites with thresholds and condition categories used to evaluate CSCI scores (from Rehn et al. 2015). Note: colors in this figure differ from other figures in this report.

2.4.3 Estimating Extent of Healthy Streams in SF Bay Area

To estimate overall extent of biological conditions in streams within the RMC area, cumulative distribution functions (CDFs) of biological condition scores were generated. Because the survey focused significantly more effort in urban areas compared to non-urban areas, sample weights were re-calculated as the total stream length in the sample frame, and divided by the stream length evaluated in each land use category. Therefore, sites contribute a proportional amount of stream length to the extent estimates, based on the number of sites assessed in each land use category. Sites without evaluations (6%), primarily non-urban sites, were excluded from the analysis. The adjusted sample weights were used to estimate the proportion of stream length represented by CSCI, D18, and S2 scores both regionwide and for urban

sites only. Estimates for non-urban streams were not calculated separately due to the lower number of monitoring events at non-urban sites and greater width of confidence intervals. Condition estimates and 95% confidence intervals were calculated for all sampled sites in the RMC sample frame and for urban sites only. Post-stratification of the urban sites by County was also performed. However, Solano County was excluded from this assessment, due to the relatively low sample size compared to the other areas. All calculations were conducted using the R-package *spsurvey* (Kincaid and Olsen 2016). See Section 4.4 for further discussion of the RMC sample design.

2.4.4 Evaluating the Importance of Stressors

2.4.4.1 Random Forest Analyses

Stressor association with biological condition scores was evaluated using random forest statistical analyses. Random forest analysis is a non-parametric classification and regression tree (CART) method commonly applied to large datasets of multiple explanatory variables. Recent papers describe their use for stressor identification in stream bioassessment studies (e.g., Maloney et al. 2009, Waite et al. 2012, Mazor et al. 2016). Random forest models use bootstrap averaging to determine splits of numerous trees (Elith et al. 2008) for reducing error and optimizing model predictions. Model outputs provide an ordered list of importance of the explanatory variables that can be applied to a new or validation dataset for prediction.

Random forest models were developed using the R-package *randomForest* to determine a list of explanatory variables related to biological condition scores (CSCI or D18 score). The stressor data consisted of 49 variables, related to (1) water quality; (2) habitat; and (3) land use factors that could potentially influence condition scores (Appendix 1, Table A). Subsequently, the data were partitioned into training (80%) and validation (20%) sets for model testing. A random selection of samples was generated by sub-sampling from within each RMC County to maintain a regional balance of samples within the partitioned datasets. The training dataset had 278 sites, while the validation data encompassed 76 sites across all counties.

First, several iterations of the model procedure were performed with the training data set to optimize the random forests, including tuning the model to the maximum number of predictors per branch, the number of trees to build, and validation of the predictions. Appendix 1 presents the results of initial steps to optimize the random forest model outputs. The final set of models evaluated a maximum of 6 predictor interactions, and 1000 trees. Two variable importance statistics were used to estimate the relative influence of predictor variables: (1) % Increase in MSE = percent increase in mean-square-error of predictions as a result of variable values being permuted; (2) Increase in Node Purity = difference between the residual sum-of-squares before and after a split in the tree. More important variables achieve larger changes in MSE and node purity. K-fold cross validation of the selected models was performed to assess prediction error, by evaluating residual error and R-squared differences.

Random forest models were developed in two steps: (1) random forest models were run with all variables included ($N = 49$), retaining the top 10 variables in the variable relative importance list ranked by % increase in MSE, and (2) random forest models were re-run with just the top 10 variables from step 1. Subsequently, the variable list was further trimmed by evaluating the corresponding variable importance scores, partial dependency plots, and the change in R^2 once the variable was excluded. Partial

dependency plots show the predicted biological response based on an individual explanatory variable with all other variables removed. No variable with less than 10% influence on CSCI or D18 predictions was retained in the final models. Finally, random forest models were used to predict biological condition scores for the validation data set. Appendix 1, Figure B presents the observed and predicted values for the validation models with CSCI and D18 in Steps 1 and 2 of the model development.

2.4.4.2 Stressor Thresholds and Relative Risk Assessment

Relative risk analyses were also conducted to evaluate associations between stressors with biological condition scores. From the list of potential stressors discussed in Section 2.3.4, eight variables were selected to conduct a relative risk analyses (Table 3). Six of the stressor thresholds were derived from statewide data collected for the Perennial Streams Assessment (SWAMP 2015). The thresholds were based on the 90th percentile of data collected at bioassessment sites that exhibited good biological condition (i.e., CSCI scores > 0.92, likely intact). The 90th percentile of stressor values at these sites was used to define the most-disturbed thresholds for variables where higher values indicate more disturbance (SWRCB 2015). Similarly, the chlorophyll a threshold (100 mg/m²) used for this report (Table 3) was based on 90th percentile of data that was collected at all RMC sites that had CSCI scores > 0.92 (Figure 2). The threshold for Dissolved Oxygen (7.0 mg/l) was based on Water Quality Objectives (WQOs) for COLD Freshwater Habitat Beneficial Use in the Water Quality Control Plan for the San Francisco Basin (SFBRWQCB 2017).

Table 3. Biological condition and stressor variable thresholds used for relative risk assessment.

Variables	Thresholds		Units	Reference	Criteria
	Poor	Good			
Biological Condition					
CSCI Score	< 0.625	≥ 0.925		Mazor et al. 2016	
Stressor Condition	High	Low			
Dissolved Oxygen (DO)	<7.0	≥ 7.0	mg/L	SF Bay Water Quality Control Plan	WQO
Specific Conductivity (SpCon)	> 1460	≤ 1460	us/cm	SWAMP 2015	90 th Percentile of sites with CSCI score > 0.925
Chloride	> 122	≤ 122	mg/L		
Total Nitrogen (TotN)	> 2.3	≤ 2.3	mg/L		
Total Phosphorus (TotP)	> 0.122	≤ 0.122	mg/L		
Chlorophyll a (Chla)	> 100	≤ 100	mg/m ²	RMC data	
Sand and Fines (SaFn)	> 69	≤ 69	%	SWAMP 2015	
Human Disturbance Index (HDI)	> 1.3	≤ 1.3			

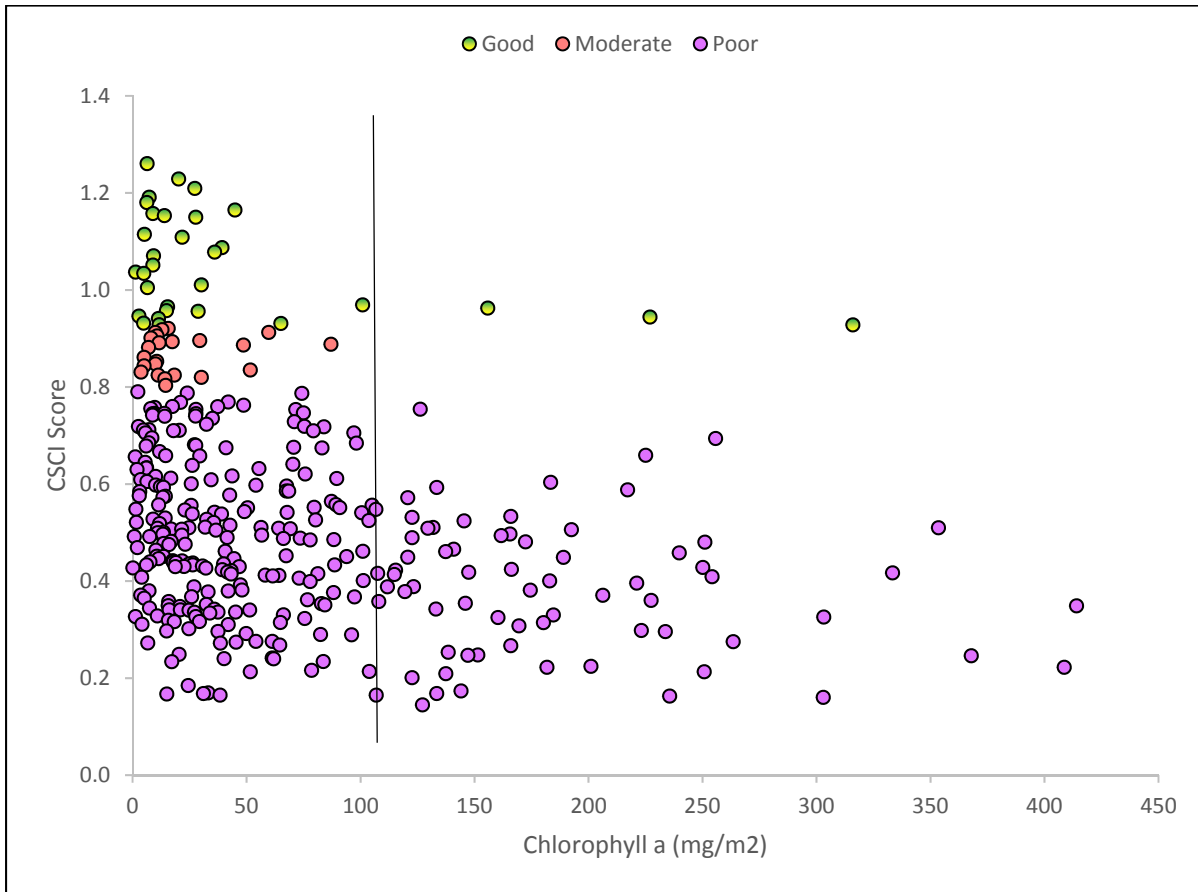

Figure 2. Plot of CSCI score and *chlorophyll a* concentration at RMC sites. Threshold for *chlorophyll a* used for relative risk assessment is shown. Sites classified as “good” include the two highest CSCI condition categories.

The relative risk approach was used to evaluate the association between stressors and biological condition (Van Sickle et al., 2008). The relative risk is a conditional probability representing the likelihood that poor biological condition is associated with high stressor levels and is calculated as follows:

$$\text{Relative Risk} = \frac{\Pr (CSCI_p)/S_h}{\Pr (CSCI_p)/S_l}$$

The numerator is the probability of finding poor biological condition ($CSCI_p$) given high stressor scores (S_h) and denominator is the probability of finding poor biological condition given low stressor scores (S_l). Poor biological conditions were defined as CSCI scores < 0.625. High and low stressor levels are defined in Table 3. In cases where RR is equal to 1, there is no association between stressor and biological indicator score. Where $RR > 1$, the higher the value, the more likely poor biological condition would occur given high stressor levels.

3 RESULTS

3.1 SITE EVALUATION RESULTS

A total of 354 monitoring sites were sampled in the RMC region between 2012 and 2016. These are identified as “target” sites in Figure 3 and Table 4. Samples were collected at 284 urban sites (80%) and 70 non-urban sites (20%) (Table 4). The greatest number of non-urban sampling locations were in Santa Clara (n=25) and San Mateo Counties (n=19). Samples were collected at 8 or 9 non-urban sites for each of the other counties.

The population of 354 monitored sites was obtained through the evaluation of 1,455 unique sites, which equate to a rejection rate of 76% for entire RMC area over the 5-year period. Solano County had the highest rejection rate (90%) and San Mateo County had the lowest (65%). The most common reason for site rejection (55% of all evaluated sites) was that a site did not present the physical requirements to support monitoring within a 300-meter radius of target coordinates. These “non-target sites” were rejected for several reasons, including lack of flowing water, site was not a stream (e.g., aqueduct or pipeline), tidally influenced, or non-wadeable. The lack of flow was the most common reason for rejection. The extended drought period between 2012 and 2014 may have resulted in an unusually high number of sites with no or low flow conditions during the target index period.

Another reason for site rejection was the inability to obtain access to conduct the sampling (e.g., physical access or obtain private land/permission). These “target non-sampleable” sites comprised 21% of sites that were rejected. These sites were often located on private land in non-urban areas where permissions were not granted and/or where steep, highly-vegetated conditions prevented access. Obtaining access to sites in urban areas was variable by county. For example, most of the streams in the urban area of San Mateo County are privately owned, while most of the urban sites in Santa Clara County are owned by municipal jurisdictions and water district agencies, making permissions more easily obtained.

Table 4. Number of sites per county in each site evaluation class.

County	Target Not-Sampleable		Non-Target		Target		Total by County
	Non-Urban	Urban	Non- Urban	Urban	Non- Urban	Urban	
Alameda	12	74	162	91	9	96	444
Contra Costa	12	34	32	89	9	48	224
San Mateo	21	42	9	37	19	41	169
Santa Clara	37	24	74	161	25	87	408
Solano	44	3	109	34	8	12	210
Total RMC	126	177	386	412	70	284	1,455
% of Total RMC	9%	12%	27%	28%	5%	20%	-

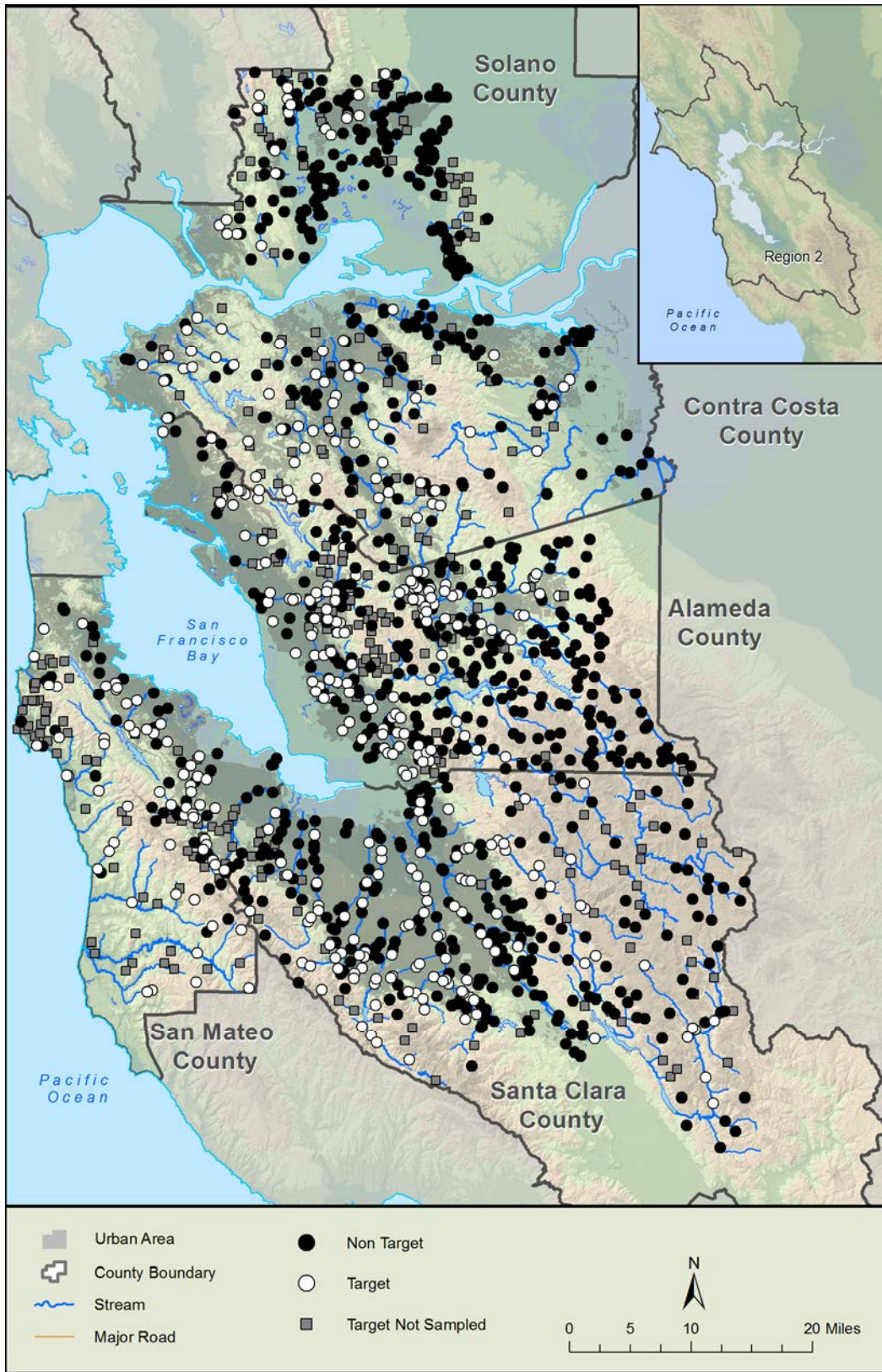

Figure 3. RMC sites evaluated by evaluation class.

Figure 4 presents rainfall for the 2000-2017 time period at the San Francisco Airport. Rainfall was generally below average during the 2012-2016 period, especially in 2014, and therefore, the RMC monitoring occurred in a drier-than-normal period. Because biological condition index scores can vary natural due to multi-year climatic patterns, it is important to note that the 5-year period of monitoring may not be representative of the long-term condition.

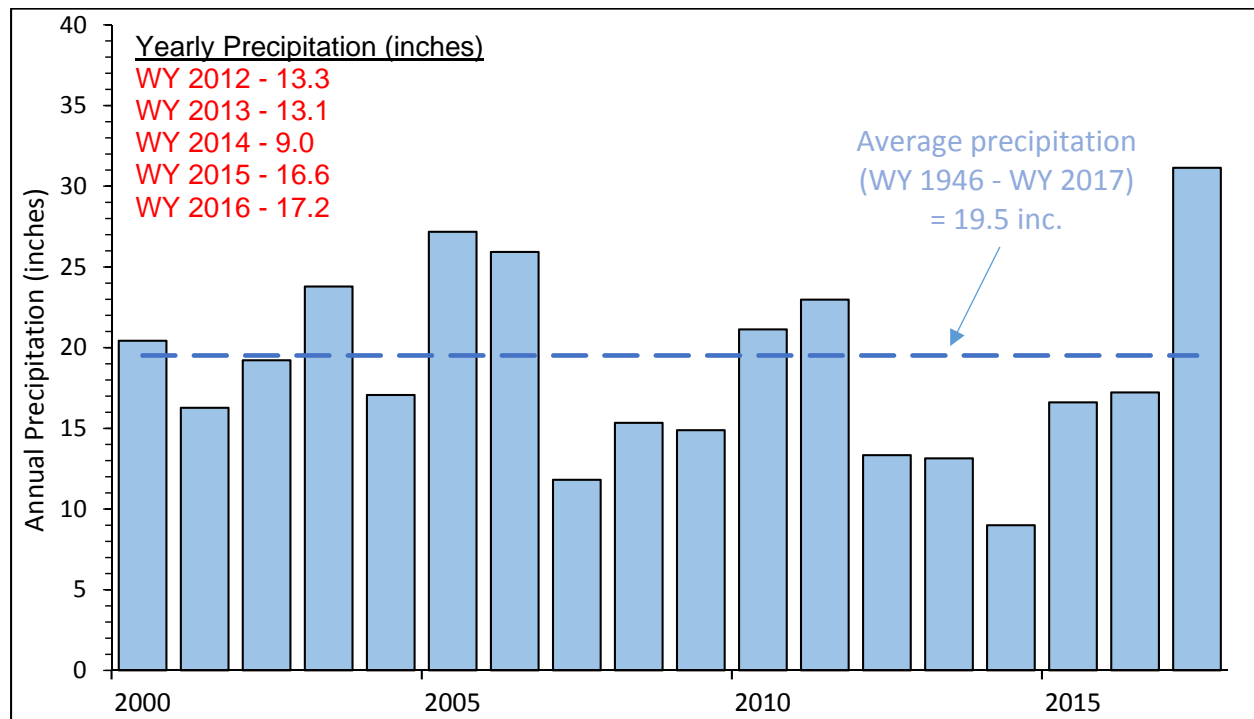

Figure 4. Annual precipitation at San Francisco Airport (2000-2017)

3.2 BIOLOGICAL CONDITION OF BAY AREA STREAMS

3.2.1 Regional Assessment

The distribution of BMI and algae index scores observed during 2012-2016 suggests that the majority of streams in the RMC sample area do not exhibit healthy biological conditions. Figures 5, 6 and 7 show cumulative distribution functions of the biological index scores for the entire regional dataset (i.e., urban and non-urban sites) and the urban dataset. Across all sites, over half (58%) of the stream-length was in the lowest condition class for CSCI (Very Likely Altered) and 15% of the stream-length was in the highest condition class (Likely Intact) (Figure 5).

Both of the algae index scores (D18 and S2) exhibited higher condition scores than CSCI regionally. For D18 (diatoms), 41% of the stream-length in the Bay Area was in the Very Likely Altered condition class and 19% of the stream-length was in the Likely Intact condition class (Figure 6). Similar distribution of

scores was evident with S2 (soft-algae), where less than half (44%) of the stream-length was in the Very Likely Altered condition class and 21% of the stream-length was in the Likely Intact condition class (Figure 7). The higher proportion of sites in the Likely Intact condition for algae indices compared to CSCI suggest that the algae communities in streams may be less degraded than BMI assemblages.

Bay Area wide, urban sites were responsible for the majority of poor CSCI scores. Seventy-nine percent (79%) of the stream length in urban areas was in the Very Likely Altered condition category for CSCI, while only 3.5% was in the Likely Intact class (Figure 5). Additionally, over 80% of the sampled stream length in urban areas was below the MRP trigger for CSCI scores (0.795), where potential follow-up source/stressor identification studies should be considered.

The influence of urban sites on the stream condition of all sites was also apparent for algae scores, although to a lesser degree than for CSCI. For D18, just over half (53%) of the stream length in urban areas was in the Very Likely Altered condition class, compared to 9% in the Likely Intact class (Figure 6). For S2 scores, 65% of stream length in urban areas was in the Very Likely Altered class, and only 7% in the Likely Intact class (Figure 7). These patterns suggest that stressors in the urban landscape may still exert influence on algae condition. Section 4.0 provides additional discussion about the results presented here.

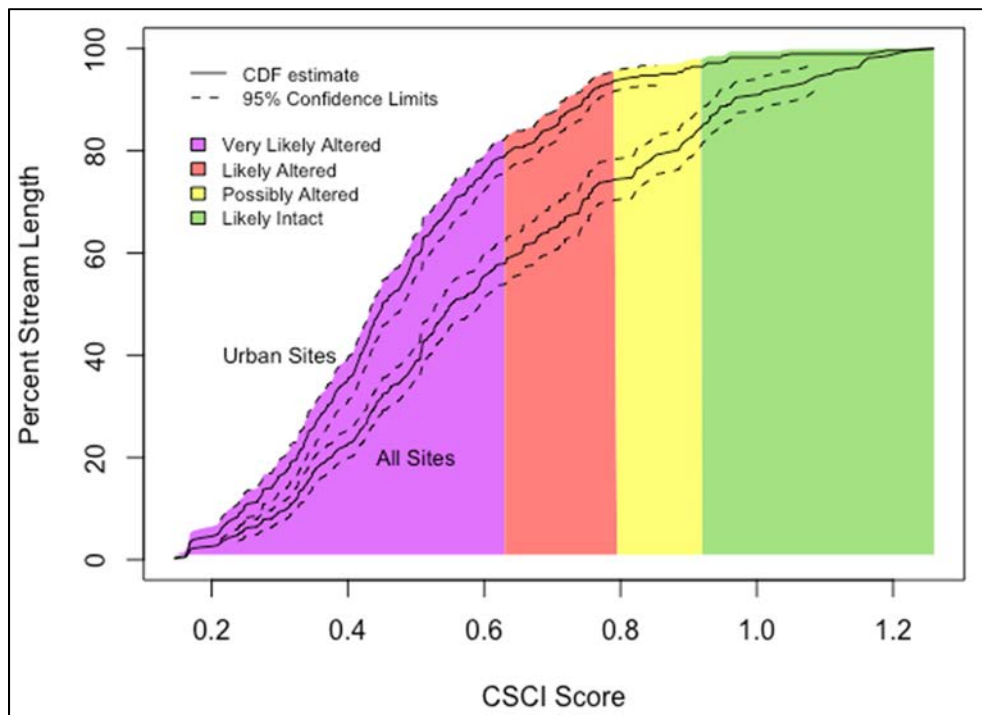

Figure 5. Cumulative distribution function (CDF) of CSCI scores at all RMC sites and urban sites.

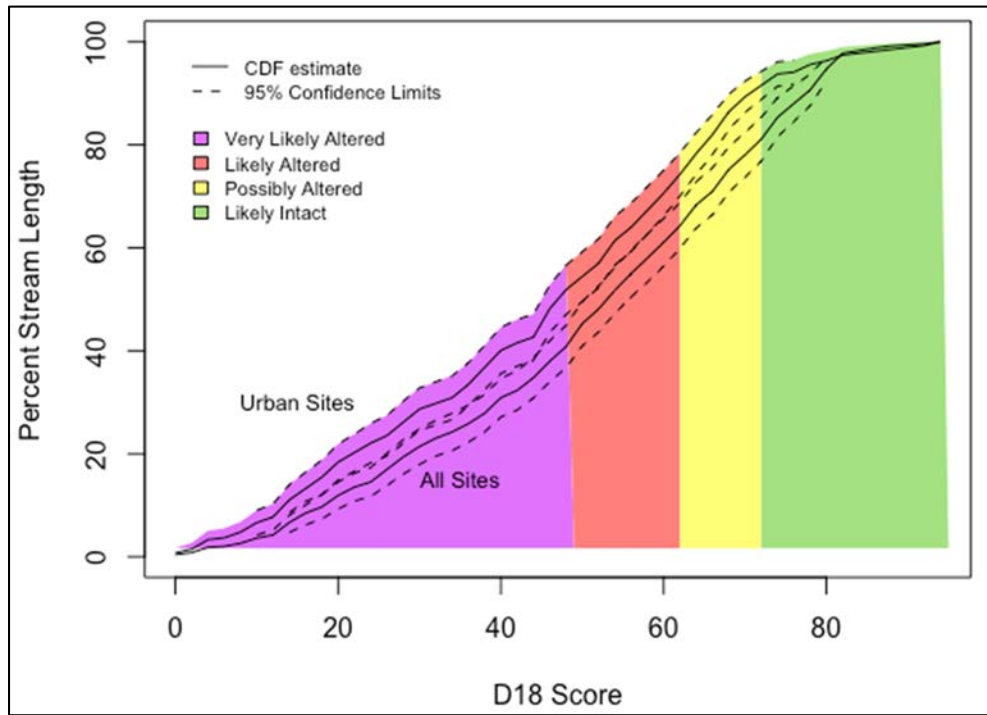

Figure 6. Cumulative distribution function (CDF) of D18 scores at all RMC sites and urban sites.

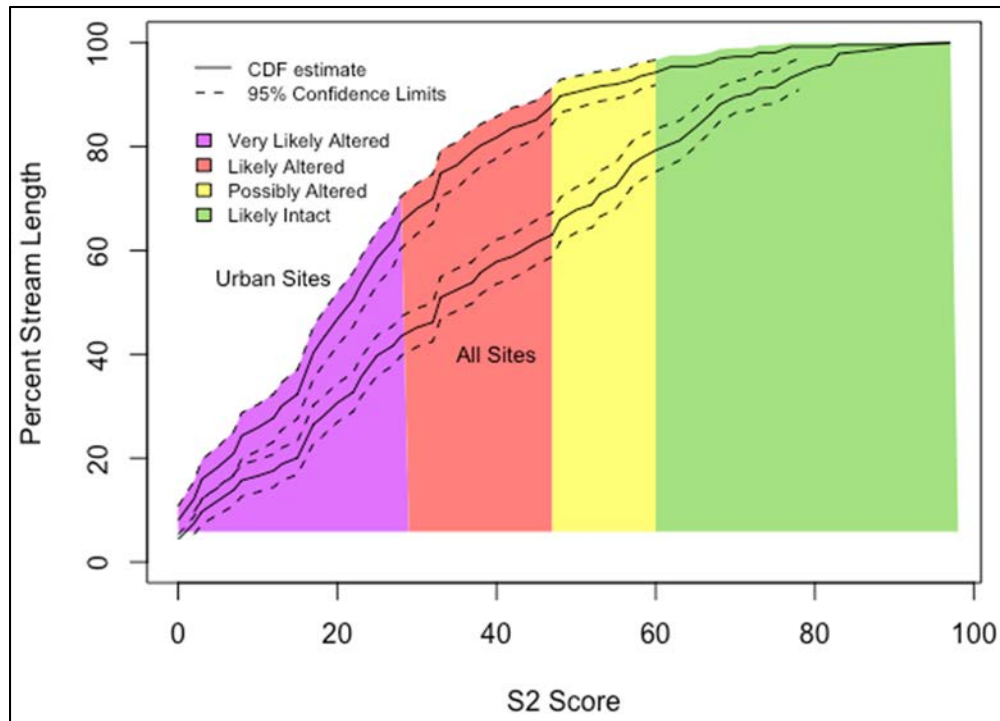

Figure 7. Cumulative distribution function (CDF) of S2 scores at all RMC sites and urban sites.

3.2.2 County Assessment

In addition to Bay Area wide biological condition estimates of streams, post-stratification of the CSCI condition estimates for urban sites in each County (excluding Solano County due to low sample size) suggests that poor condition scores are widespread in each Bay Area county. The proportion of urban stream length in the Very Likely Altered condition class was highest for Contra Costa (96%), followed by Alameda County (83%), San Mateo County (73%), and Santa Clara County (64%) (Figure 8). Less than 10% of the urban stream length in each of the counties was in the Likely Intact condition class. The highest proportion of Likely Intact BMI communities occurred in San Mateo and Santa Clara counties (7% each), followed by Alameda (1%) and Contra Costa (0%) counties. In comparison to the MRP threshold of 0.795, the vast majority of urban streams in each county fall below this threshold.

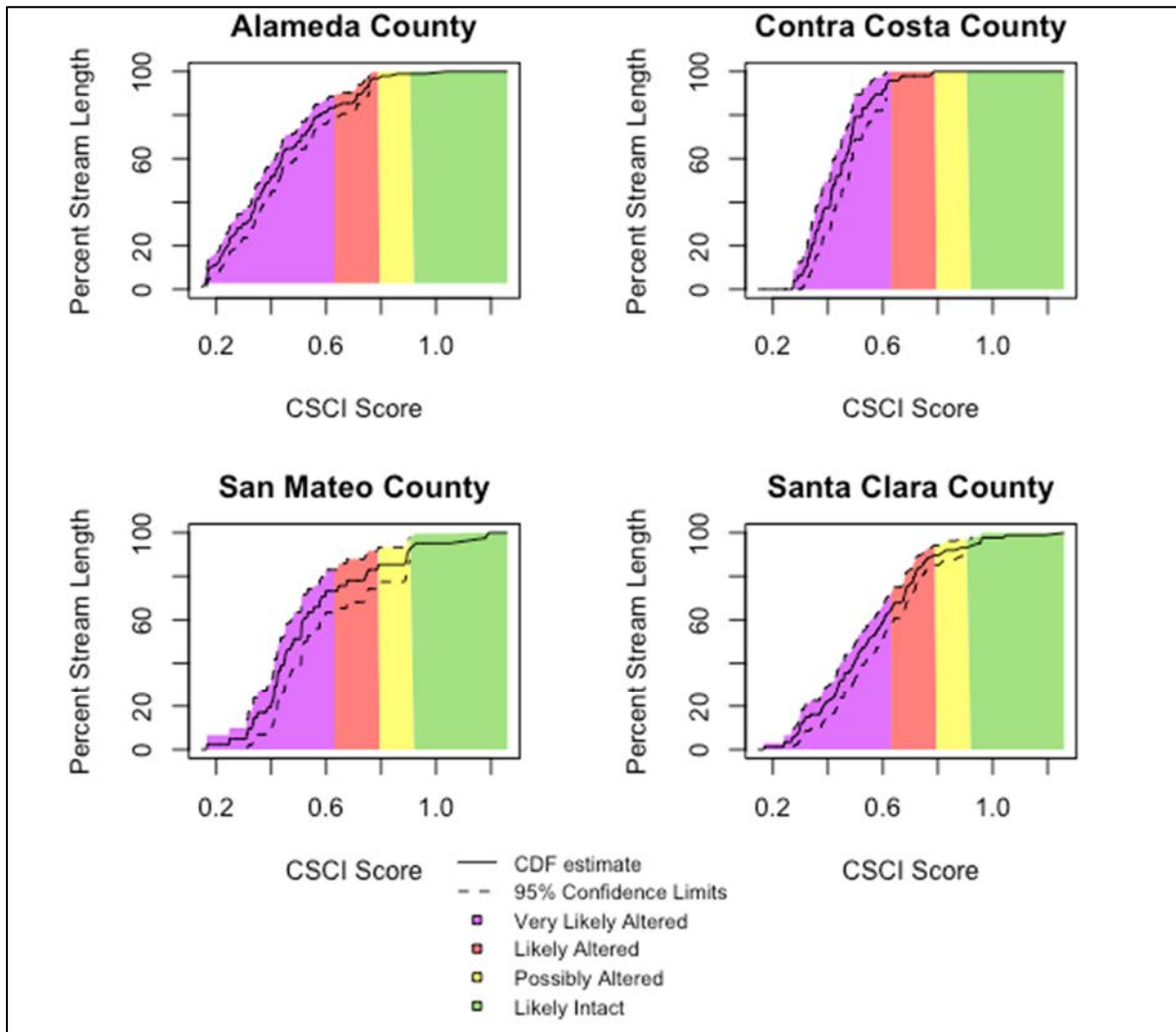

Figure 8. Cumulative distribution functions of CSCI scores at RMC urban sites in each participating Bay Area County.

3.2.3 Biological Condition of Urban and Non-Urban Streams

Figure 9 illustrates CSCI scores (by condition category) for the region and includes county boundaries and urban areas for reference. Maps illustrating the biological condition of stream in each county based on CSCI and D18 scores are included in Appendix 4.



Figure 9. Biological condition of streams in the RMC area based on CSCI scores.

CSCI scores grouped by land use class (urban vs. non-urban) showed that all counties, with the exception of Solano, exhibit higher scores in non-urban areas (Figure 10), which generally span a narrower scoring range than urban sites. Santa Clara and San Mateo counties had the highest median CSCI scores compared to other counties, with several sites in both counties receiving scores greater than 1.0, which typically represent reference conditions. However, non-urban sites for all five counties had CSCI scores below the MRP trigger (0.795), indicating that some sites non-urban areas have degraded biological condition.

Stratification of D18 and S2 scores by land use (urban vs non-urban; Figures 11 and 12) suggests that biological condition scores based on algae metrics generally mirror CSCI scores, which are based on BMIs. Generally, algae scores in the non-urban area were higher than scores for sites in urban areas within each county. The low sample sizes of the non-urban population preclude making any definitive comparisons, however, it was noteworthy that sites in the urban areas may receive similar or higher algae index scores than sites non-urban areas.

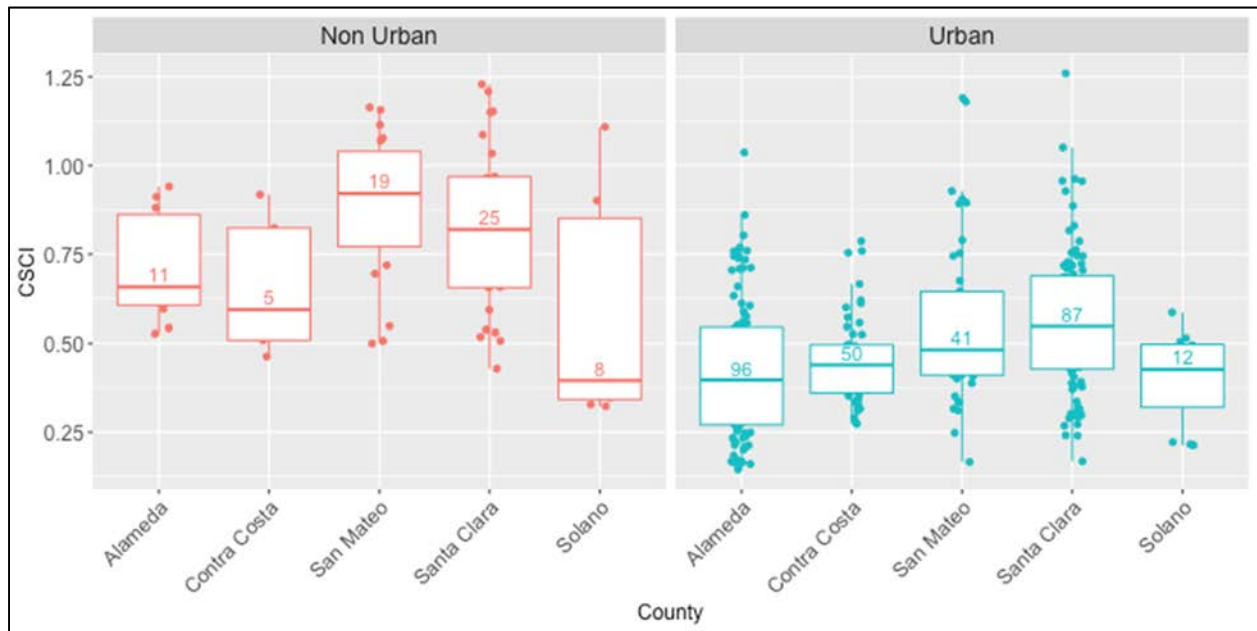

Figure 10. CSCI scores for urban and non-urban sites in each County. Sample sizes for each county are included in each boxplot.

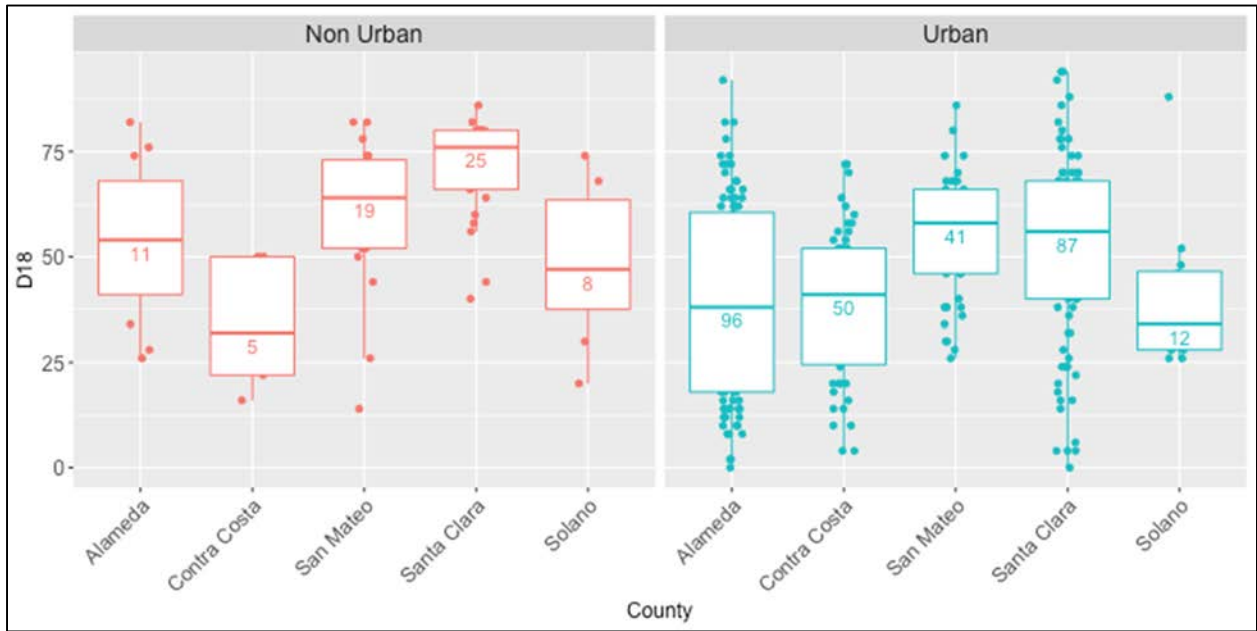

Figure 11. D18 scores for urban and non-urban sites in each County. Sample sizes for each county are included in each boxplot.

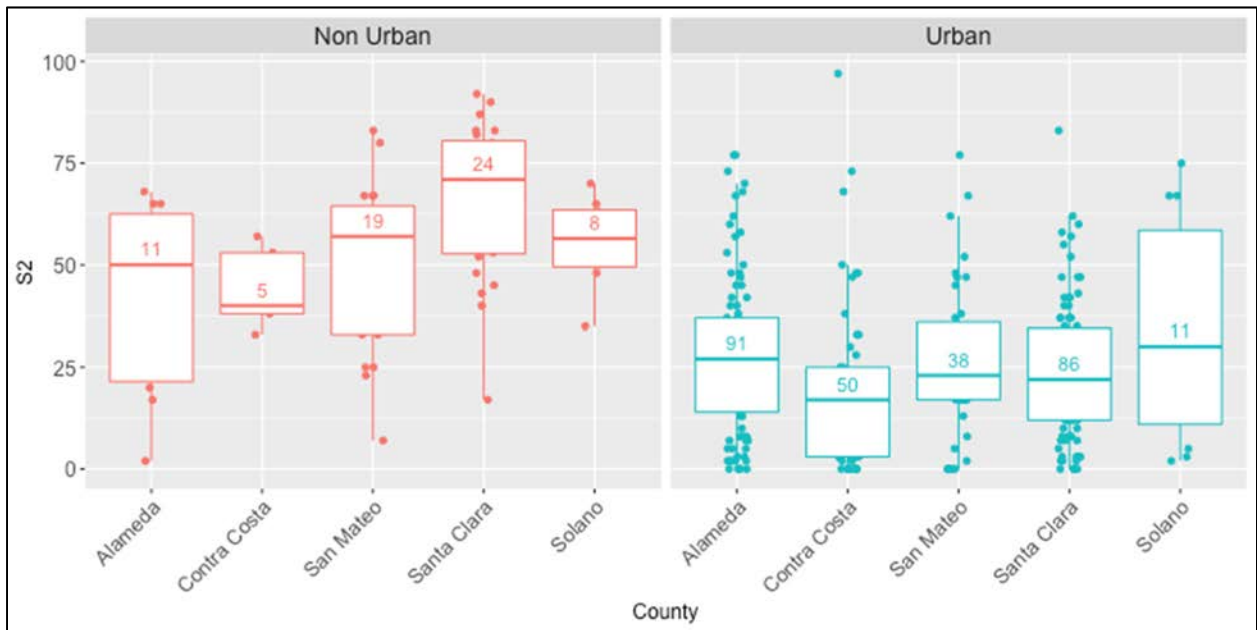

Figure 12. S2 scores for urban and non-urban sites in each County. Sample sizes for each county are included in each boxplot.

3.3 STRESSORS ASSOCIATED WITH BIOLOGICAL CONDITION

3.3.1 Random Forest Model Outputs

To evaluate stressors associated with biological condition within the RMC area, random forest models were developed using the CSCI and D18 index results. A parallel analysis was not performed for the S2 indicator due to the lack of soft algae at many of the assessment sites. Stressor data consisted of 49 variables grouped into three types: (1) water quality; (2) habitat; and (3) land use (Appendix 1, Table A). Model results clearly indicated better relationships between stressors and the CSCI, versus the D18 index. Validation of the final random forest models showed that the CSCI model explained 61% of the variance using eight predictor (stressor) variables, while the D18 model only explained 34% of the variance using six predictors.

The CSCI random forest model indicated that land use and physical habitat variables were most influential to most biological condition (Table 5). Of the eight variables in the final CSCI model, four were landscape-based (HDI, PctImp_5K, PctImp_1K, PctImp), three were habitat associated (PctFines, PctGra, PctFstH20), and one was a water quality variable (Dissolved Oxygen, DO). There was general consistency amongst the individual variables within each of the landscape and habitat groups. The landscape variables that were most influential to CSCI scores were associated with the degree of human impact/imperviousness and the habitat variables were associated with the characteristics of the sediment substrate and water flow. Overall, the largest influence on the CSCI random forest model was percent impervious area within a 5 km radius (35.2%) of the site. The other seven variables in the final model exerted a lesser, but similar degree of influence (18.8 – 25.3%) on CSCI scores. It was notable that none of the nutrient variables were identified as indicators of biological condition scores using the CSCI model (Appendix 3 Figure A). The same may be true for DO, where the apparent relationship was driven by a few high values (Appendix 3 Figure B).

Table 5. Summary statistics for the CSCI random forest model. Rank of importance of selected stressor variables are colored according to categories: physical habitat (green), land use (brown), and water quality (blue). The correlation coefficient (rho) for each stressor variable is also presented.

Stressor Variable	% Increase MSE	Increase Node Purity	Rank Correlation Coefficient (Rho)
Percent Impervious Area in 5km (PctImp_5K)	35.21	4.74	-0.62
Percent Impervious Areas of Reach (PctImp)	25.37	1.03	-0.59
Dissolved Oxygen (DO)	24.43	1.60	0.24
Percent Fast Water of Reach (PctFstH20)	22.52	1.62	0.51
Percent Fines (PctFin)	20.73	1.13	-0.36
Percent Substrate Smaller than Sand (PctSmaSnd)	20.64	1.36	-0.46
Percent Impervious Area in 1km (PctImp_1K)	20.64	2.26	-0.61
Human disturbance Index (HDI)	18.81	1.45	-0.62

The results of the random forest model for D18 indicated that different variables explained biological condition than the CSCI model. Water quality variables exerted greater influence in the D18 model (Table 6). Of the six variables in the final D18 model, four were water quality variables (SpCond, Chloride, AFDM, Phosphorus), one was a habitat variable (PctSmalSnd), and one was a landscape variable (RdDen_1k). Overall, the variable with the largest influence on the random forest model was specific conductivity (29.5%). The remaining five variables exerted a lesser, but similar influence (12.5% – 22.0%) on the model. The importance of water quality variables in the model suggests that general water quality conditions (e.g., conductivity) likely influence algae condition scores. Specific types of water quality stress, such as from nutrients, however, appear to be less important to algal community condition on a regionwide scale.

Table 6. Summary statistics for the D18 random forest model. Rank of importance of selected stressor variables are colored according to categories: physical habitat (green), land use (brown), and water quality (blue). The correlation coefficient (rho) for each stressor variable is also presented.

Stressor Variable	% Increase MSE	Increase Node Purity	Rank Correlation Coefficient (Rho)
Specific Conductivity (SpCond)	29.55	35357.81	-0.49
Percent Substrate Smaller than Sand (PctSmalSnd)	21.99	24671.80	-0.46
Phosphorus	21.93	17465.87	-0.33
Chloride	18.53	18873.52	-0.51
Ash Free Dry Mass (AFDM)	15.09	21937.23	-0.44
Road Density in 1km (RdDen_1k)	12.51	16383.17	-0.33

Using the random forest model outputs, plots of individual stressor variables versus observed response values (i.e., CSCI and D18 scores) were developed to illustrate relationships between stressors and biological condition (Figures 13 to 18 and Appendix 2). For the CSCI model output, the plots of habitat and landscape variables indicate patterns of dose-response. For example, the Human Disturbance Index (HDI) stressor variable indicated that poor condition scores are observed when HDI exceeds a value of 2. This pattern was also evident in the regressions of observed CSCI values, relative to HDI and separating out HDI scores by their condition class (Figure 13). It is worth noting that Ode et al. (2016) identified a cutoff of HDI = 1.5 for reference sites (Ode et al. 2016). Based on the analysis conducted on this five-year Bay Area dataset, the range between 1.5 and 2.0 appeared to separate out the urban and non-urban sites, supporting the previous authors’ assertion that sites with HDI values below this range exhibit reference conditions.

Similar to HDI, the stressor variables related to imperviousness indicated a threshold-style response with CSCI scores. For the variable ‘percent imperviousness in 5km’, a value above 10% appeared to correspond to poor CSCI condition scores (Figure 14). All sites that had less than 10% impervious area within 5km were classed as either Possibly Intact or Likely Intact condition. In the case of the habitat variables included in the final model, response patterns were less pronounced than for the landscape variables (Figure 15). For example, the variable ‘percent reach habitat smaller than sand’, indicated that poor sites spanned a wide-range in stressor values, while sites in the top three condition classes had a much

narrower range in this metric. Biological condition at sites where more than 50% of the stream reach had substrate smaller than sand appeared to be a line of demarcation between the bottom two and top three condition categories.

The results of the D18 model indicated dose-response relationships between biological condition and all four water quality variables (i.e. SpCond, Chloride, AFDM, Phosphorus), however there were less obvious patterns delineating biological condition. For example, the partial dependency plots for D18 scores indicated that poor condition (i.e., bottom two condition categories) was evident when chloride was above 200 mg/L (Figure 16) and specific conductivity was above 1200 $\mu\text{S}/\text{cm}^6$ (Figure 17). However, the plots of observed D18 values relative to these variables suggested that only some of the lowest scoring sites could be delineated using these threshold values. Similarly, response patterns of the habitat variables were inconclusive for delineating biological condition. A value of approximately 60% or greater of the stream habitat 'smaller than sand' corresponded to lower D18 scores (Figure 18), but there was considerable variability to this signal.

⁶ This corresponds well with the MRP threshold of 2000 uS/cm^2 for evaluating continuous monitoring data. Sites with 20% or more of instantaneous specific conductance results greater than 2000 uS/cm^2 are considered as candidates for SSID projects.

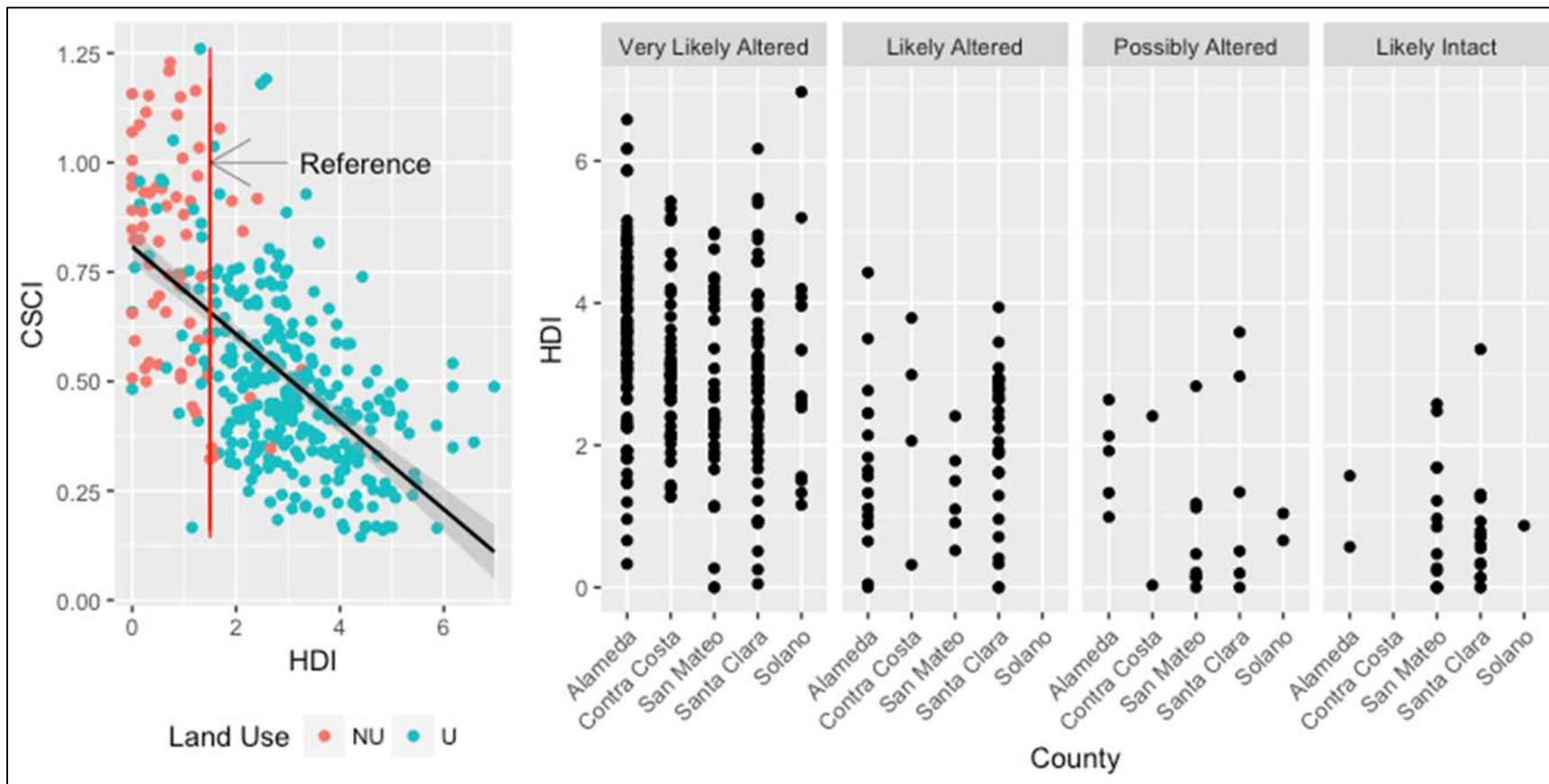

Figure 13. Relationship of CSCI scores to the Human Disturbance Index (HDI) stressor indicator. Red line indicates a reference condition cutoff of 1.5 (Ode et al. 2016).

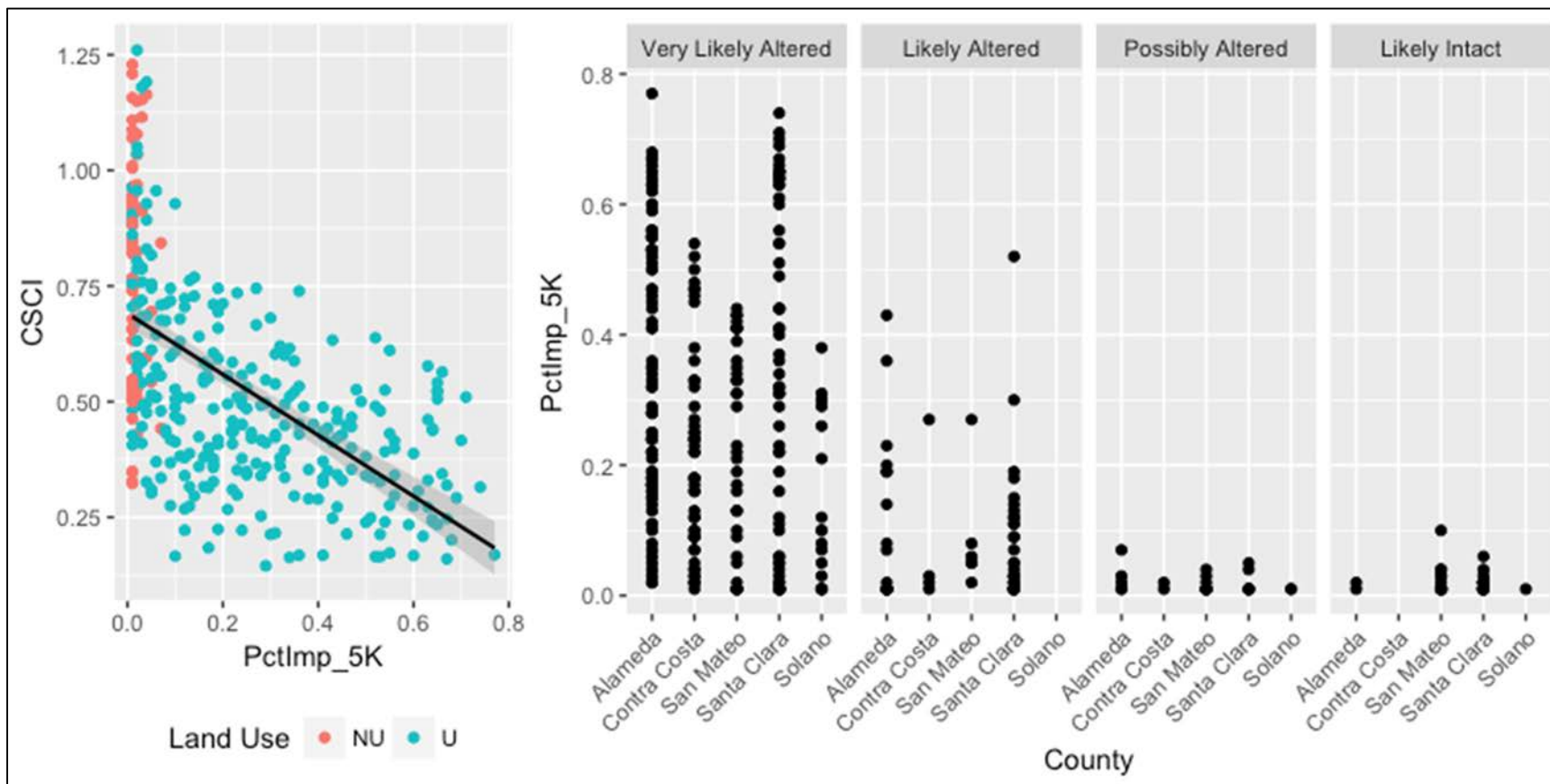

Figure 14. Relationship of CSCI scores to the percentage of land area in a 5 km radius (km²) around the site that is impervious.

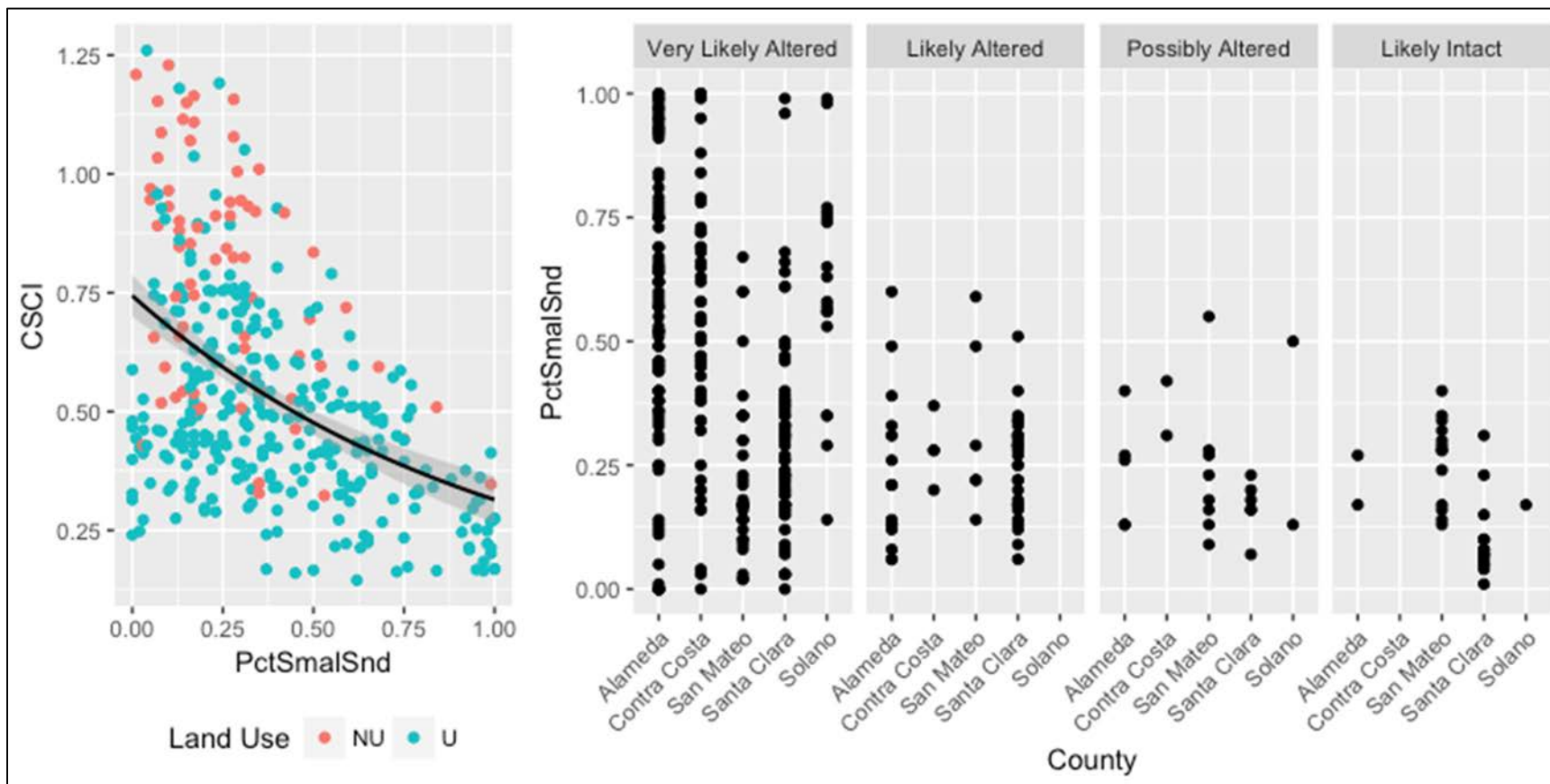

Figure 15. Relationship of CSCI score to the percent of substrate in the stream reach that was smaller than sand.

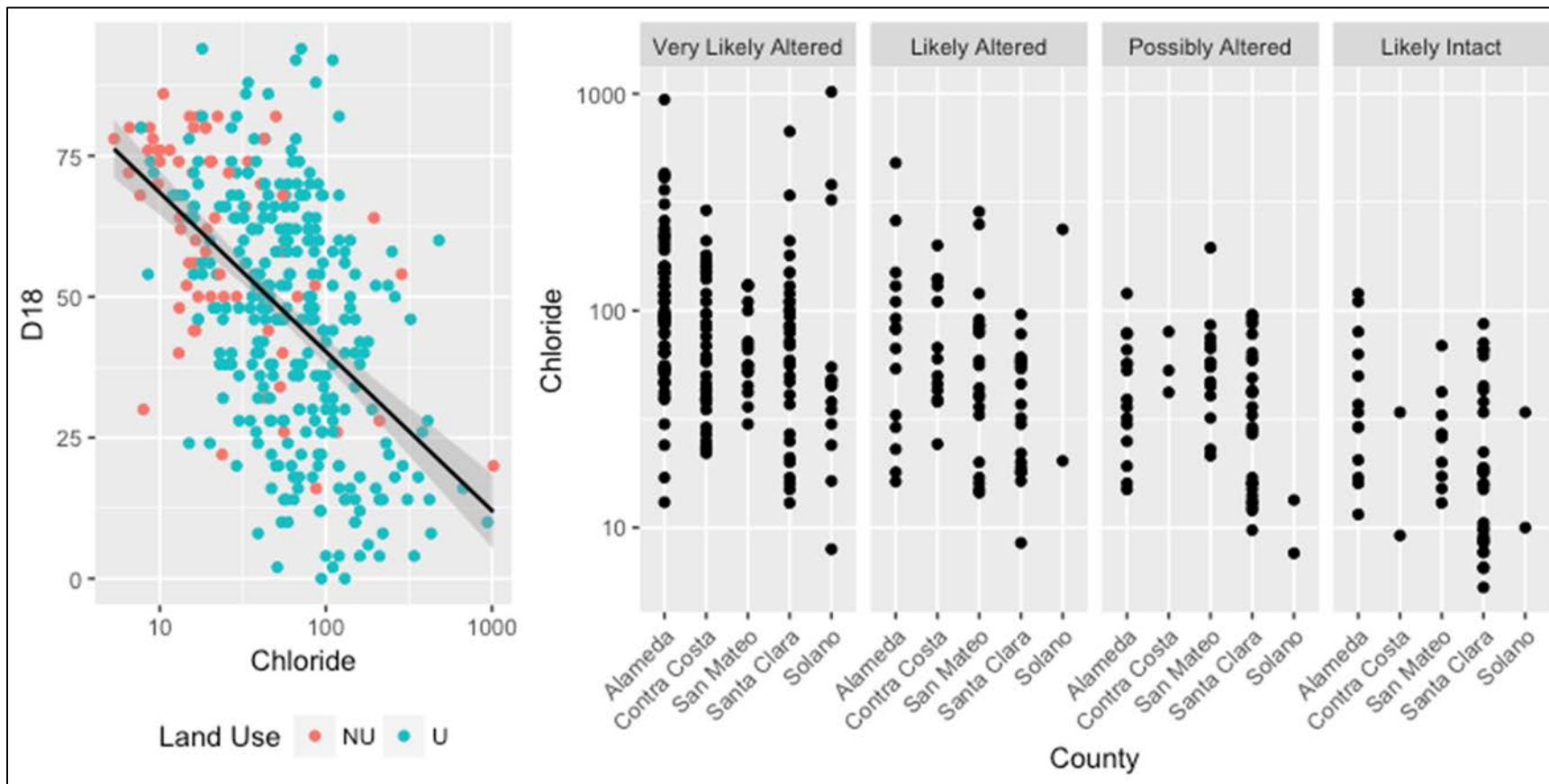

Figure 16. Relationship of D18 score to chloride concentration (mg/L). Note the chloride concentration scale is displayed in log units.

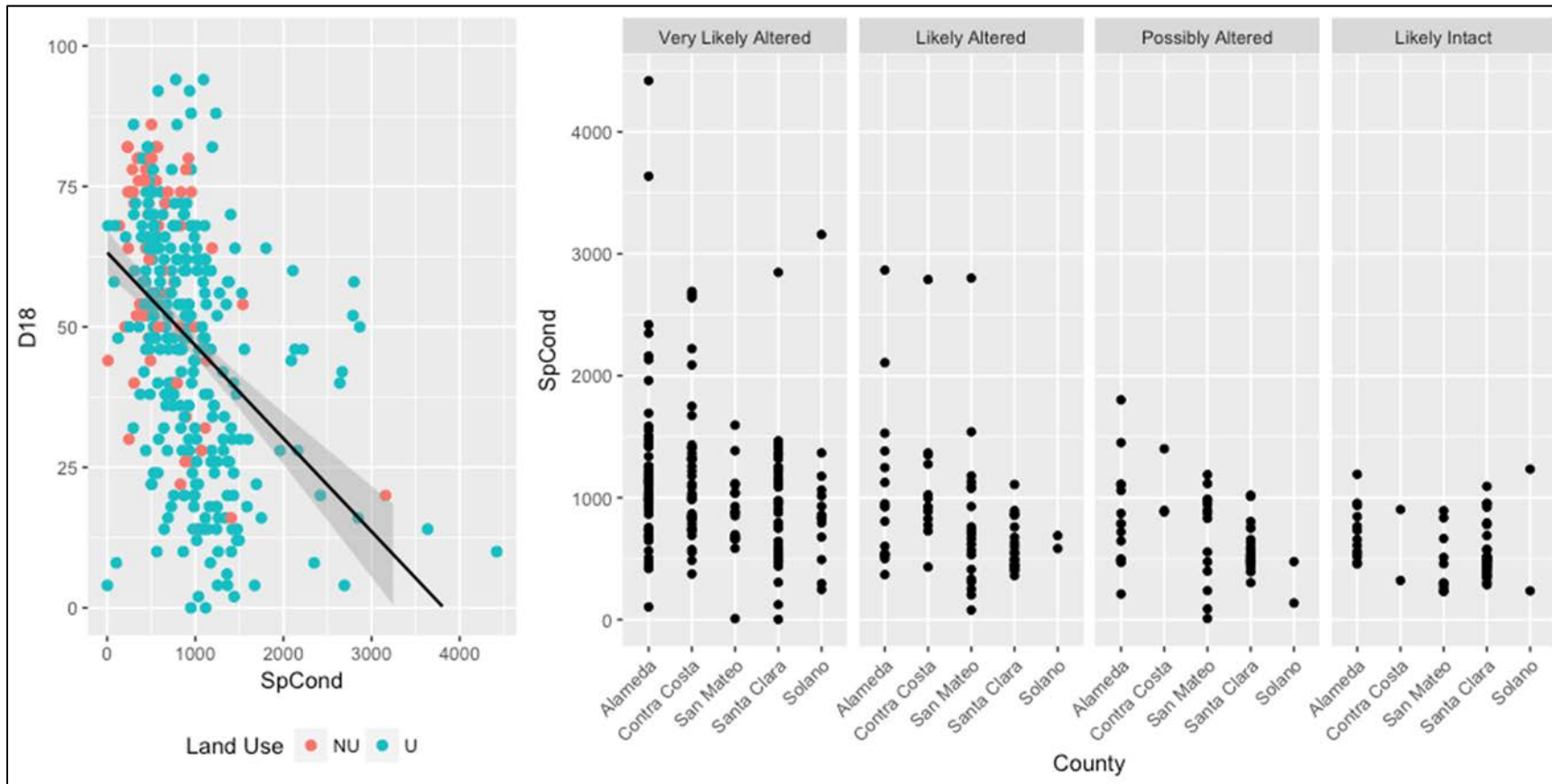

Figure 17. Relationship of D18 score to specific conductivity ($\mu\text{S}/\text{cm}$).

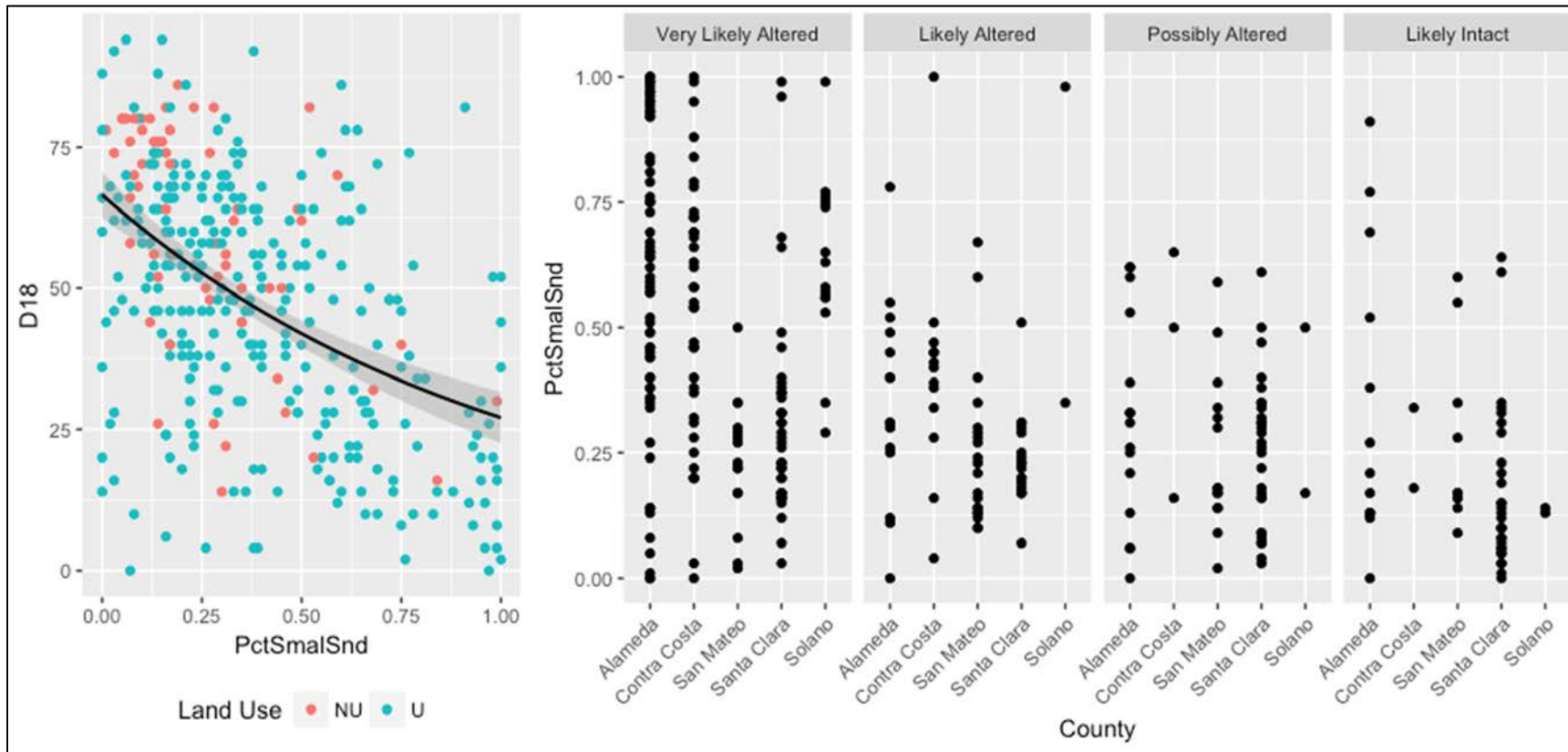

Figure 18. Relationship of D18 score to the percent of substrate in the stream reach that was smaller than sand.

3.3.2 Relative Risk Outputs

The relative risk of several stressors that may impact biological condition (based on CSCI scores) is shown in Figure 19. Definitions of abbreviations and threshold values for relative risk are described in Section 2.4.5. The Human Disturbance Index (HDI) stressor had the strongest relationship (> 3.0) with poor biological condition observed in the RMC dataset. Of the remaining physical habitat stressor variables, percent substrate smaller than sand (SmalSnd) had the strongest relationship (1.56) with poor biological condition. The remaining six stressors evaluated were associated with water quality and water chemistry and had Relative Risk values ranging between 1.26 and 1.51. These results are consistent with the random forest model results presented in the previous section, suggesting that physical habitat variables are more strongly associated with biological condition (based on CSCI scores) in the Bay Area, compared to water quality variables.

The relative risk for the eight stressors evaluated for RMC study were consistent with the results of the relative risk analysis of the same stressors that was conducted by the SMC (Mazor 2015a), with the exception of nutrients. The SMC study showed that relative risk for both Total Nitrogen and Phosphorus slightly under 3.0, while the RMC analysis indicated a much lower relative risk for each of these water quality parameters. The differences in relative risk of nutrients in Northern and Southern California suggest that there may be regional differences in the effects of these water quality parameters on biological condition (based on CSCI). However, it is important to note that the threshold values used by the SMC for Total Nitrogen and Phosphorus were lower than those used in the RMC data analyses.

Please note that the relative risk estimates for the eight stressors illustrated in Figure 19 could not be compared among RMC counties due to the insufficient number of sites with biological conditions above and below stressor thresholds in some counties.

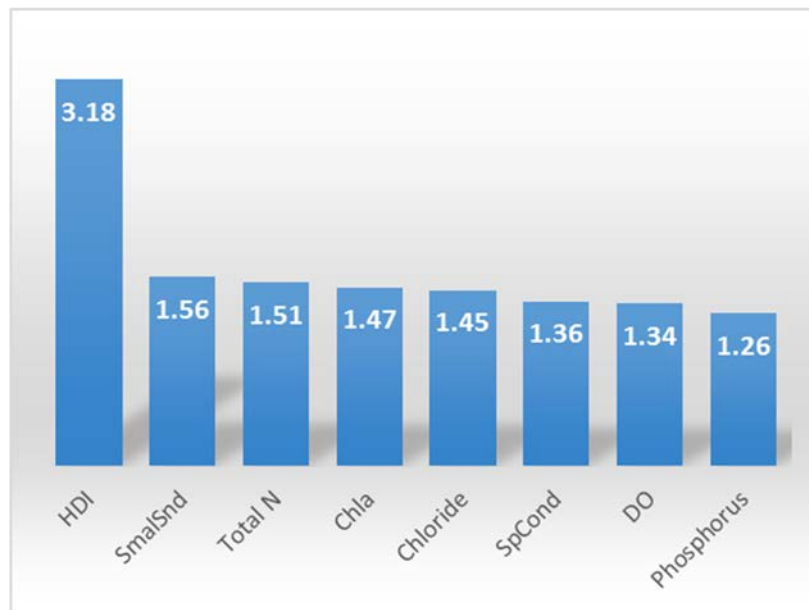

Figure 19. Relative risk of poor biological condition (i.e., scores in the lowest two CSCI condition categories) for sites that exceed stressor disturbance thresholds.

3.4 TRENDS

During the 2012-2016 monitoring period, there was no obvious temporal trend in biological condition, using either the CSCI, D18 or S2 indices. The median annual CSCI score for non-urban sites fluctuated between 0.518 and 0.931, but estimates in three of five years (2012, 2015, 2016) were only based on data collected at ten sites or less. Estimates were particularly imprecise for 2016, where only five non-urban sites were sampled. In urban areas, the median scores for CSCI had a much smaller range (0.408 to 0.510) than scores at non-urban sites. For urban sites, there was a clear lack of temporal trend, with 2016 exhibiting the highest median of the five years monitored (Figure 20).

D18 and S2 scores in each of the water years followed a similar pattern to CSCI scores. Scores in non-urban areas tended to vary widely depending on the water year and number of sites assessed (Figures 21 and 22). However, the urban sites tended to be relatively consistent, with scores generally being within a similar range each year. One observation to note was that S2 scores at urban sites were generally lower in 2016, compared to the preceding years of the survey, while CSCI scores were higher in 2016.

A comparison of median scores for CSCI each year and accumulated rainfall in each County did not reveal clear patterns on a county-by-county basis (Figure 23). Annual rainfall, as measured at San Francisco International Airport, during the five-year survey period was generally below the long-term average (Figure 5). Regional differences in accumulated rainfall additionally contribute to the lack of discernible changes in condition over time at a regional scale.

Contra Costa exhibited the highest range in accumulated rainfall during the monitoring period (10-20 inches) and generally had consistently low median CSCI scores. Alameda and Santa Clara counties, however, experienced a similar range in accumulated rainfall (5-16 inches), but had very different median CSCI scores in each water year. Given the variations in CSCI scores during different water years in some counties, future analyses to evaluate temporal trends in biological conditions will likely need to consider the influence of climatic variation at the county and regional-scales.

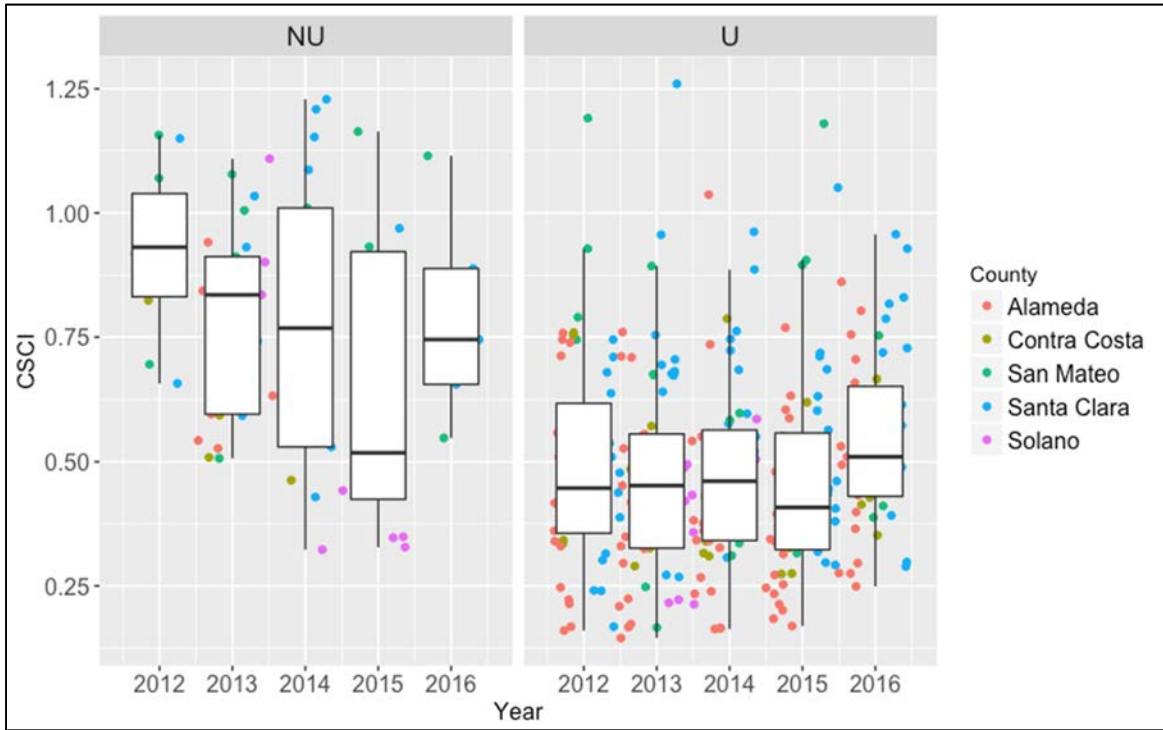

Figure 20. Distribution of CSCI scores during water years 2012-2016. NU = non-urban, U= urban.

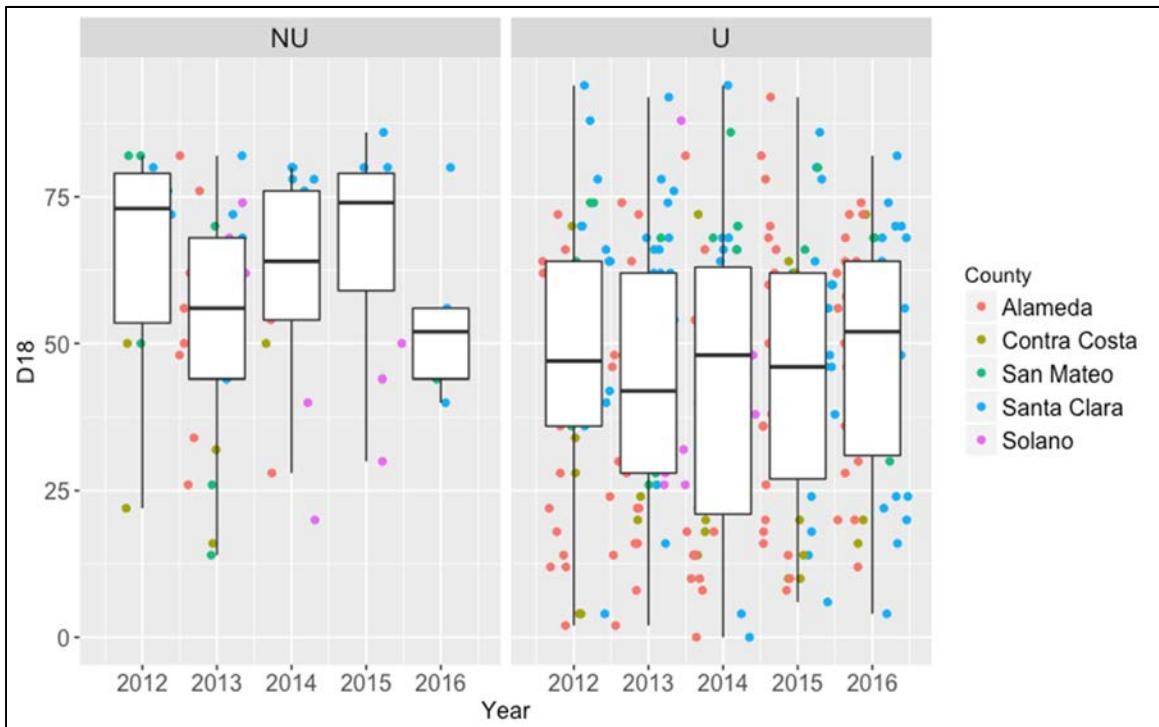

Figure 21. Distribution of D18 scores during water years 2012-2016. NU = non-urban, U= urban.

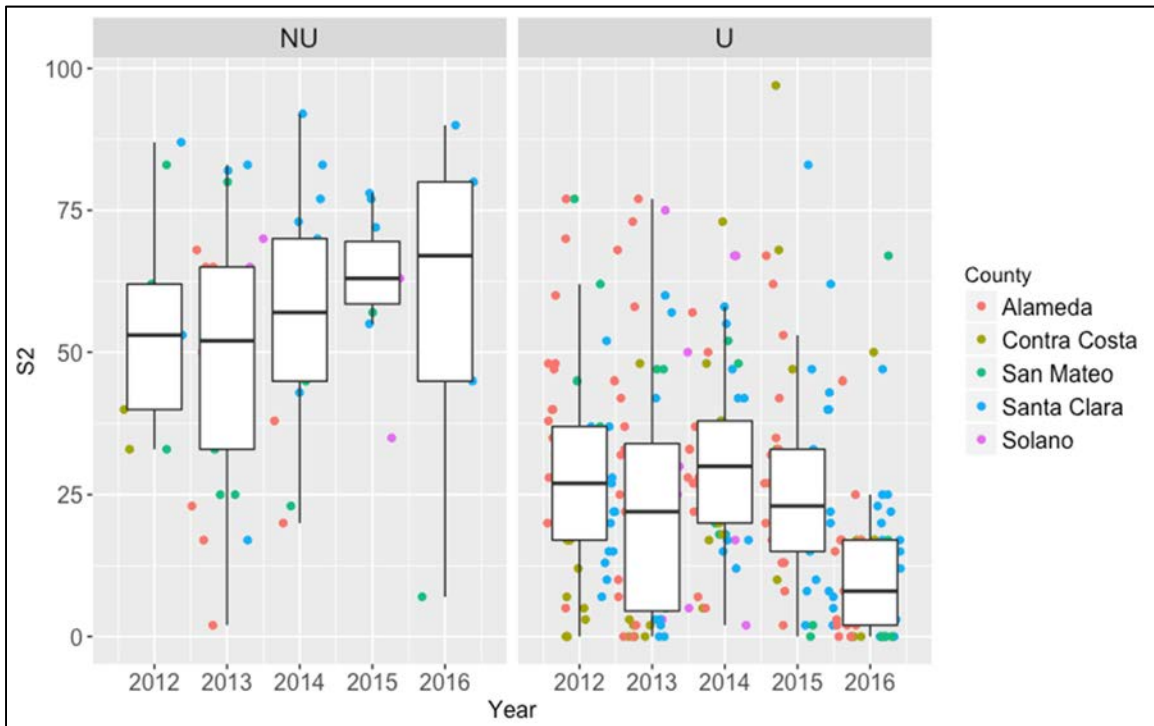

Figure 22. Distribution of S2 scores during water years 2012-2016. NU = non-urban, U= urban.

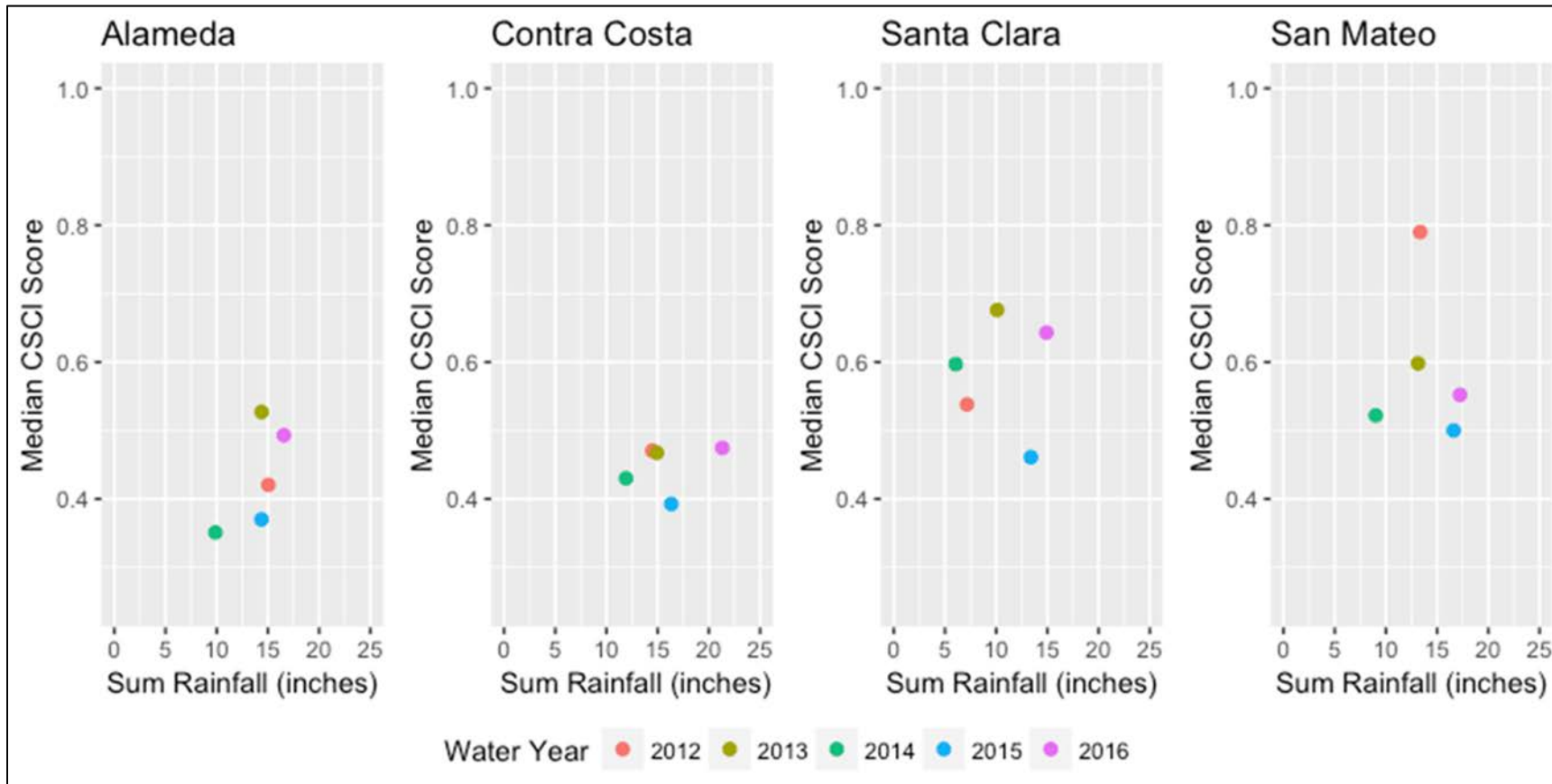

Figure 23. Relationship between median CSCI scores and accumulated annual rainfall in each County during water years 2012-2016. Includes urban and non-urban sites.

4 FINDINGS AND NEXT STEPS

The results and conclusions of the RMC's five-year bioassessment data evaluation are discussed below as they relate to the management questions and goals identified for the project.

4.1 WHAT ARE THE BIOLOGICAL CONDITIONS OF STREAMS IN THE RMC AREA?

Regional Conditions

The biological conditions of streams in the RMC area were assessed using two ecological indicators: BMIs and algae. The probabilistic survey design was developed to provide an objective estimate of biological condition of sampleable streams (i.e., accessible streams with suitable flow conditions) at both the RMC area and countywide scale.⁷ Results of the survey indicate that streams in the RMC area are generally in poor biological condition:

- The CSCI for benthic macroinvertebrates (BMIs) indicates that 58% of stream length in the region are in the lowest CSCI condition category (Very Likely Altered); 74% of the of the sampled stream length exhibited CSCI scores below 0.795, the MRP trigger for potential follow-on activity.
- Using both algae indices (D18 and S2), stream conditions regionwide appear slightly less degraded than when using CSI, with approximately 40% of the streams ranked in the lowest algae condition category (Very Likely Altered). The algal indices also indicate that greater stream lengths (19-21%) are in the highest condition category (Likely Intact) compared to lengths in this category when the CSCI is used (15%).

These findings should be interpreted with the understanding that the survey focused on urban stream conditions. Approximately 80% of the samples (284 of 354) were collected at urban sites. As a result, the overall condition assessment represents the range of conditions found in the urban area, which is defined in the sample frame as areas classified as "urban" in the US Census (2000), plus all areas within city boundaries. Although the low non-urban sample size precludes making any definitive comparisons, bioassessment scores in the non-urban area were higher than scores in the urban area for each of the RMC counties. In general, the biological condition assessment for the RMC area (with a focus on urban sites) was consistent with the statewide assessment of biological conditions at sites located within urban land uses (PSA 2015), which resulted in more than 90% of urban streams rated in the two lowest biological condition categories using CSCI.

Differences Across Counties

One of the goals for the RMC monitoring design was to compare biological conditions of streams between counties. In general, biological conditions, based on CSCI and D18 scores, appeared better in streams located in Santa Clara and San Mateo counties, compared others. However, Santa Clara and San Mateo counties had proportionally more non-urban sites (with higher CSCI and D18 scores) compared to other

⁷ More samples are needed to estimate condition for non-urban land use areas and finer spatial scales (i.e., watersheds).

counties. All counties exhibit higher biological condition scores in the non-urban area compared to the urban area. The difference between urban and non-urban median scores is lower for the D18 index, suggesting that diatoms may respond less to the habitat degradation commonly found at urban sites and may therefore provide better response to changes in water quality conditions.

Higher overall scores in Santa Clara and San Mateo may also be associated with regional differences in rainfall and flow duration. For example, San Mateo County and western Santa Clara County watersheds drain the Santa Cruz mountains, which typically receive higher rainfall, in contrast to Alameda and Contra Costa counties, which primarily contain watersheds that drain the western slopes of the drier Diablo range.

Indicator Tools

The use of multiple indicators provides a broad assessment of ecosystem functions. Streams that show degraded conditions for a single indicator may provide opportunities to identify the stressor and potentially implement management controls to reduce impacts. Alternatively, streams with poor conditions for both indicators (BMI and algae) may have multiple stressors that might be more challenging to address. Watershed managers may also choose to prioritize streams that are in good biological condition, based on both biological indicators, for protection of beneficial uses.

The RMC used existing tools to assess biological condition (CSCI and SoCal Algal IBIs). Although these tools were also used in the regional assessments conducted by the SMC, uncertainty remains as to how well these indices perform for streams within the San Francisco Bay Region:

- The CSCI is a statewide index that was developed for perennial streams. For the RMC project, however, the CSCI was used to evaluate BMI data collected in both perennial and non-perennial streams (note: the RMC assessed flow status by conducting site visits at all sampled sites during the dry season). In addition, CSCI scores appear highly sensitive to physical habitat degradation, which occurs frequently in the many highly modified urban streams monitored by the RMC. It is not clear how well the CSCI tool can show response to stressors associated with water quality, when physical habitat is the primary factor affecting the BMI community.
- For this report, the RMC evaluated algae data using SoCal Algae IBIs for diatoms (D18) and soft algae (S2). The D18 was more responsive to stressor gradients associated with water quality, however, high scores were often found in urban sites with highly degraded physical habitat. The soft algae index (S2) was not a reliable indicator of condition due to overall low taxa richness observed at both disturbed and undisturbed sites throughout the RMC area. In many cases, there was insufficient number of soft algae taxa to calculate S2, resulting in data gaps and lack of utility of the S2 index. Additional testing of soft algae indices is needed to assess the utility of this indicator in the RMC area.

The State Water Board and Southern California Coastal Water Research Project are currently developing and testing a set of statewide indices using benthic algae data as a measure of biological condition for streams in California. The statewide Algae Stream Condition Indices (ASCIs) are expected to be finalized in 2019. It is anticipated that the RMC will apply the ASCIs to analyze algae data when they become available.

4.2 WHAT STRESSORS ARE ASSOCIATED WITH BIOLOGICAL CONDITIONS?

This question was addressed by evaluating the relationships between biological indicators (CSCI and D18) and stressor data through random forest and relative risk analyses. The study results indicate that each of the biological indicators responded to different types of stressors and therefore the two may be best used in combination to assess potential causes of poor (or good) biological conditions in streams:

- Biological condition, based on CSCI scores, is strongly influenced by physical habitat variables and land use within the vicinity of the site. The percent of the land area within a 5 km radius of a site that is impervious appears to have the largest influence on CSCI scores based on the random forest model results. Based on the relative risk analysis, the degree of human disturbance near a site, as observed via the Human Disturbance Index (HDI), appears to have the greatest relationship with poor biological condition of streams.
- Biological condition, based on D18 scores, is moderately correlated with water quality variables and less associated with physical or landscape variables, such as imperviousness or HDI.

In general, CSCI scores at urban sites were consistently low in all RMC counties, indicating that degraded physical habitat conditions in and around streams do not support healthy in-stream biological communities. D18 scores at urban sites were more variable, indicating that healthy diatom assemblages can occur at sites with poor physical habitat and may be important water quality indicator these sites.

No nutrient variables (e.g., nitrate, total nitrogen, orthophosphate, phosphorus) correlated strongly with CSCI scores in the Bay Area, nor were nutrients ranked as important variables explaining CSCI scores via the random forest model. Phosphorus and ash-free dry mass, which increase in response to biostimulation, were important in predicting algae (D18) index scores, although no statistically significant relationships were observed. This finding suggests that nutrient targets currently under development by the State Water Board as part of their Biostimulatory/Biointegrity Project, should be applied in the context of observed biological conditions, not uniformly based solely on broad relationships that may not apply to the Bay Area streams.

Although results show associations between some stressors and biological condition, they do not establish causation. There are several factors that may affect the strength of the correlation between stressors and biological condition:

- Stressors are not independent of one another and may have synergistic or mediating effects on condition. For example, elevated temperatures reduce the amount of oxygen that can be dissolved in the water column and both stressors may result in adverse effects to aquatic biota.
- Potential variability of stressor concentrations over time may not be represented in a single grab sample. For example, dissolved oxygen can have a wide range of concentrations over a 24-hour period. Drops in DO concentrations typically occur in early morning hours, potentially well prior to the timing of measurements during bioassessment events.
- Many of the physical habitat variables can be highly variable throughout the sample reach. For example, a wide range of substrate grain sizes can occur within a single transect. Thus, degraded habitat conditions that may exist at selected transect(s) of the assessment reach may not be well represented in reach-wide averages used as endpoints for the stressor analysis.

- Stressor impacts may be dependent on other factors (possibly not measured) for negative effects to occur. For example, elevated nutrient concentrations do not necessarily result in eutrophication (i.e., excessive plant and algal growth, reduced oxygen levels). Stream locations that have minimal exposure to sunlight, cooler water and higher flow rates may not develop eutrophic conditions, despite presence of elevated concentrations of nutrients.
- Stressors may have natural sources; prevalence and magnitude may vary by watershed or regionally. For example, naturally occurring nitrogen or phosphorus concentrations may be present in minimally disturbed upper watershed areas.

4.3 *ARE BIOLOGICAL CONDITIONS CHANGING OVER TIME?*

The short timeframe of the survey (five years) limited the ability to detect temporal trends in bioassessment data. Since new sites are surveyed each year, it is expected that a much longer time period is needed to detect trends at a regional scale over time. The variability in biological condition observed over the five years of the current analysis may have been associated with annual variation in precipitation or other factors. Drought conditions were present during the first four years of the survey. Trends in biological condition are more likely to occur on the decadal timescale. That said, the PSA evaluated trends for unique probabilistic sites sampled over a 13-year period and observed no trends (i.e., consistent directional change over time) (PSA 2015).

It is also important to consider these results within the broader context of the progress made over the past decade to reduce the effects of urbanization on creeks and channels through the mandatory treatment of stormwater and reduction of impervious areas via applicable new and redevelopment projects, and the numerous stream restoration projects that have been put into place. The implementation of mandatory stormwater treatment via green stormwater infrastructure (GSI) and low impact development (LID) began prior to the adoption of the MRP in 2005. These requirements reduce the effects of stormwater from impervious surfaces created via new and redevelopment and likely have positive effects on biological condition in streams, although the responses may be delayed. Bay Area municipalities are currently developing GSI Plans, which will result in the strategic and widespread integration of GSI into Capital Improvement Projects and other co-benefit projects like regional stormwater capture projects, creek restoration and flood control and resiliency projects. These efforts are anticipated to further reduce the impacts of stormwater on local streams. Future creek status monitoring may provide additional insight into the potential positive impacts of GSI and creek restoration on water quality and beneficial uses in urban creeks.

The ability to detect trends would be increased if the sample design included re-visiting sites over multiple years. Multiple surveys at individual sites would provide more site-specific detection of changing biological conditions over time. Should RMC participants intend to use BMIs and algae as long-term indicators, analyses should be conducted to identify the minimum number of samples needed over a specified timeframe to detect trends at a site or within a watershed or county, with a specified level of confidence. The analysis could also be used to optimize the monitoring program by evaluating appropriate sample sizes for detecting trends when considering expected variability in condition for different groups of sites, land use types, or areas where management actions are being implemented.

4.4 EVALUATION OF MONITORING DESIGN

The information presented below is intended to provide recommendations on potential revisions RMC monitoring procedures that should be considered for future implementation of bioassessment programs in the Bay Area.

4.4.1 Site Evaluations

Over the first five years of monitoring, the RMC evaluated about 25% (1455 out of 5740) of the sites in the sample frame to assess 354 sites. Approximately 46% (873 out of 1896) of the total number of urban sites in the sample frame were evaluated during that time. Additional sites have subsequently been selected from the sample frame and evaluated for sampling in 2017 and 2018. The number of remaining sites for evaluation in the RMC Sample Frame for each county is presented in Table 7.

Table 7. Sites remaining in RMC sample frame before site evaluation in water year 2019.

County	Urban	Non-urban
Alameda	124	797
Contra Costa (R2)	348	307
Contra Costa (R5)		331
Santa Clara	143	1189
San Mateo	67	469
Fairfield-Suisun	37	208
Vallejo	4	

Based on rejection rates from previous years, the sample frame is anticipated to only last two to three years at which time the urban sites in the frame will be exhausted. Revision of the RMC monitoring design could seek to reduce the future rejection rate through re-evaluation of the sample frame to exclude areas of low management interest or regions that would not be candidates for sampling (such as due to lack of permissions or physical barriers to access). This would improve the spatial balance of samples that more closely represents the proportion of the sample frame that can be reliably assessed.

Each countywide stormwater program managed their site evaluation information independently using a standardized database. The site evaluation data were then compiled to conduct the spatial analysis needed to calculate the regional biological condition estimates presented in this report. During the compilation process, inconsistencies in procedures used to conduct site evaluation (BASMAA 2016a) were identified that affect the statistical certainty of the regional estimates. Some sites in the sample draw were skipped over (e.g., challenges in obtaining permissions from private land owners, lack of flow during period of drought) with the intention to re-evaluate the sites at a future date. The skipped sites created sampling bias that affects the spatial balance of the draw and reduces certainty in the condition estimates.

Another issue was the disproportionate sampling of non-urban sites among the counties. The RMC intended to sample twenty percent of the targeted sites each year. Some Programs had difficulty getting

access to non-urban sites, or decided to focus on urban sites, resulting in a wide range in number of samples collected at non-urban sites across the counties. As a result, biological condition scores at the county-scale tended to be higher in counties that sampled more non-urban sites.

4.4.2 RMC Sample Frame

Consistent with the PSA, the RMC sample design was created to probabilistically sample all streams within the RMC area, which resulted in a master list of 33% urban sites and 67% non-urban sites. However, because participating municipalities are primarily concerned with runoff from urban areas, the RMC focused sampling efforts on urban sites (80%) over non-urban sites (20%). As a result, non-urban samples are under-represented in the dataset resulting in much lower overall biological condition scores than would be expected for a spatially balanced dataset. In addition, the limited number of non-urban samples (2% sample frame assessed thru-2016) prevented statistical confidence in estimates of biological condition for non-urban land use at the regional scale.

Depending on the goals for the RMC moving forward, the RMC may want to consider developing a new sample draw that establishes a new list of sites that is weighted for specific land uses categories and Program areas of interest. Development of a revised sample frame would result in a new list of sites, associated with different length weights for each land use category. The sample draw could also include a list of sites for oversampling (replacements for sites not sampled) to maintain the spatial balance throughout any timeframe of the draw and allow for a much longer time frame before the list is exhausted.

Re-design of the RMC sample frame could also include new strata based on developed channel classifications created by SCCWRP. The classifications are created using a statistical model that predicts likely ranges of CSCI scores based on landscape characteristics (Mazor et al. 2018). These channel classifications could be integrated as strata into the RMC sample frame to allow varying sampling efforts for urbanized streams.

4.5 POSSIBLE NEXT STEPS FOR THE RMC BIOASSESSMENT MONITORING

Based on evaluation of data collected during the five years of the survey, several options to revise the RMC Monitoring Design are presented below:

- 1) Continue to sample new probabilistic sites until the draw is exhausted;
- 2) Re-visit probabilistic sites in support of assessing temporal trends;
- 3) Monitor targeted sites for special studies; or
- 4) Combination of two or more of the above.

Each of these options is discussed in more detail below.

Continue Sampling New Probabilistic Sites

The RMC could continue to sample new probabilistic sites from the current sample frame with the goal to establish baseline conditions over smaller spatial scales. Eventually, statistically significant datasets would be obtained to estimate biological condition for all strata previously considered (i.e., non-urban and countywide), as well as finer scales (e.g., watersheds). Smaller geographic scales of assessments may

provide stronger associations between biological conditions and stressor levels. Watershed-level assessments may provide managers more opportunities to evaluate spatial patterns and temporal trends for specific watersheds.

Exclusively sampling new sites would exhaust sites in the current sample draw. It is anticipated that at the current rate of sampling (at same proportion of urban/non-urban sites), some of the Programs would run out of urban sites in two to three years. Solano County has already depleted urban sites from their sample frame. Sampling effort at new non-urban sites should also be evaluated. Resources to conduct site evaluations (e.g., permission to access private property) are typically much higher at non-urban sites. In addition, the access to non-urban sites appears to be highly variable by county.

If this option is desired, the RMC could develop a new probabilistic sample draw with a list of oversample sites.

Re-visit Probabilistic Sites to Assess Temporal Trends

Re-visiting probabilistic sites previously sampled may provide trend estimates and more refined information to potentially explain causes of observed trends. The most robust trends scenario would involve sampling the same sites each year; however, given the current level-of-effort, this would only be possible at a relatively small number of sites in each county. Thus, the resulting trends assessment could only answer regional questions. Some sites could be sampled for multiple years to evaluate potential variability related to changes in precipitation; non-urban sites may be particularly sensitive to annual variation in precipitation. Integrating site re-visits into the sample design would have the advantage of extending the life of the sample frame (i.e., reduce number of new sites each year).

Targeted Studies

There are several potential objectives for conducting biological assessments at targeted sites, including:

- 1) Evaluate effectiveness of stream restoration/BMP implementation projects;
- 2) Determine source/stressor at impaired site (i.e., causal assessment);
- 3) Evaluate conditions in selected watersheds;
- 4) Study trends at minimally disturbed sites (e.g., climate change);
- 5) Assess validity of CSCI in nonperennial streams in the Bay Area;
- 6) Investigate variability in biological indicator scores within sampling index period.

Targeted studies could be coordinated among RMC participants to evaluate similar objectives at regional scale or could be done independently by each Program. It is anticipated that targeted studies may require more resources with regards to site selection, data needs, detailed analyses, and reporting. However, targeted monitoring could also leverage requirements that Permittees have for other projects.

Combined Approaches

The RMC may consider implementing a combination of all the approaches described above for the future monitoring design.

5 REFERENCES

- Bay Area Stormwater Management Agencies Association (BASMAA). 2016a. Regional Monitoring Coalition Creek Status Monitoring Standard Operating Procedures. Version 3, March 2016.
- Bay Area Stormwater Management Agencies Association (BASMAA). 2016b. Regional Monitoring Coalition Creek Status Monitoring Program Quality Assurance Project Plan. Version 3, March 2016.
- Elith, J., Leathwick, J. R. and Hastie, T. 2008. A working guide to boosted regression trees. *Journal of Animal Ecology* 77.4: 802-813.
- Fetscher, A. E., Stancheva, R., Kociolek, J. P., Sheath, R. G., Stein, E. D., Mazor, R. D., & Busse, L. B. 2014. Development and comparison of stream indices of biotic integrity using diatoms vs. non-diatom algae vs. a combination. *Journal of applied phycology*, 26(1), 433-450.
- Kincaid, T. M. and Olsen, A. R. 2016. spsurvey: Spatial Survey Design and Analysis. R package version 3.3.
- Maloney, K., Weller, D., Russell, M., Hothorn, T. 2009. Classifying the biological condition of small streams: an example using benthic macroinvertebrates. *J North Am Benthol Soc* 28(4): 869–884.
- Mazor, R.D. 2015a. Bioassessment of Perennial Streams in Southern California: A Report on the First Five Years of the Stormwater Monitoring Coalition’s Regional Stream Survey. SCCWRP Technical Report #844. May 2015.
- Mazor, R.D. 2015b. Bioassessment Survey of the Stormwater Monitoring Coalition. Workplan for Years 2015 through 2019. Version 1.0. SCCWRP Technical Report #849. February 2015.
- Mazor R.D., Rehn A.C., Ode P.R., Engeln M., Schiff K.C., Stein E.D., Gillett DJ, Herbst D.B., Hawkins C.P. 2016. Bioassessment in complex environments: designing an index for consistent meaning in different settings. *Freshwater Science* 35(1):249-71.
- Mazor, R., Ode, P.R., Rehn, A.C., Engeln, M., Boyle, T., Fintel, E., Verbrugge, S., and Yang, C. 2016. The California Stream Condition Index (CSCI): Interim instructions for calculating scores using GIS and R. SWAMP-SOP-2015-0004. Revision Date: August 5, 2016.
- Mazor, R., M. Beck, and J. Brown. 2018. 2017 Report on the Stormwater Monitoring Coalition Regional Stream Survey. SCCWRP Technical Report #1029. Southern California Coastal Water Research Project. Costa Mesa, CA.
- Ode, P.R., Fltscher, A.E. and Busse, L.B. 2016. Standard Operating Procedures for the Collection of Field Data for Bioassessments of California Wadeable Streams: Benthic Macroinvertebrates, Algae, and Physical Habitat. California State Water Resources Control Board Surface Water Ambient Monitoring Program (SWAMP) Bioassessment SOP 004.
- R Core Team. 2016. R: A language and environment for statistical computing. R Foundation for Statistical Computing, Vienna, Austria. <https://www.R-project.org/> (<https://www.R-project.org/>).
- Rehn, A.C., Mazor, R.D. and Ode, P.R. 2015. The California Stream Condition Index (CSCI): A new statewide biological scoring tool for assessing the health of freshwater streams. California State Water Resources Control Board Surface Water Ambient Monitoring Program (SWAMP) TM-2015-0002. September 2015.
- State Water Resources Control Board (SWRCB). 2015. Surface Water Ambient Monitoring Program (SWAMP) Perennial Stream Assessment Management Memo. SWAMP-MM-2015-0001. June 2015.
- Stevens, D.L., Jr., and Olsen, A.R. 2004. Spatially-balanced sampling of natural resources. *Journal of the American Statistical Association* 99: 262-278.

- San Francisco Bay Regional Water Quality Control Board (SFBRWQCB). 2017. San Francisco Bay Basin (Region 2) Water Quality Control Plan (Basin Plan). Incorporating all amendments approved by the OAL as of May 4, 2017.
- San Francisco Bay Regional Water Quality Control Board (SFBRWQCB). 2015. California Regional Water Quality Control Board San Francisco Bay Region Municipal Regional Stormwater NPDES Permit (MRP 2.0). Order No. R2-2015-0049. NPDES Permit No. CAS612008. November 19, 2015.
- San Francisco Bay Regional Water Quality Control Board (SFBRWQCB). 2009. California Regional Water Quality Control Board San Francisco Bay Region Municipal Regional Stormwater NPDES Permit (MRP 1.0). Order No. R2-2009-0049. NPDES Permit No. CAS612008. October 14, 2009.
- van Buuren, S. and Groothuis-Oudshoorn, K. 2011. mice: Multivariate Imputation by Chained Equations in R. *Journal of Statistical Software*, 45(3), 1–67.
- Waite, I. R., Kennen, J. G., May, J. T., Brown, L. R., Cuffney, T. F., Jones, K. A. and Orlando, J. L. 2012. Comparison of Stream Invertebrate Response Models for Bioassessment Metrics. *JAWRA Journal of the American Water Resources Association*, 48: 570-583.

APPENDICES

1. Random Forest Analysis
2. Partial Dependency Plots
3. CSCI-Stressor Plots
4. Additional Figures

APPENDIX 1 RANDOM FOREST ANALYSIS

Table 1-A. Variable group, variable code, and description of response variables (condition indices) and explanatory environmental variables (landscape, habitat, and water quality) used for random forest model development.

Variable Group	Variable Code	Description
Response	CSCI	California Stream Condition Index
Response	D18	Soft algae condition score
Habitat	AvAlgCov	Mean Filamentous Algae Cover
Habitat	AvBold	Mean Boulders cover
Habitat	AvWetWd	Mean Wetted Width/Depth Ratio
Habitat	AvWoodD	Mean Woody Debris <0.3m cover
Habitat	ChanAlt	Channel Alteration Score
Habitat	EpiSub	Epifaunal Substrate Score
Habitat	FlowHab	Evenness of Flow Habitat Types
Habitat	NatShelt	Natural Shelter cover - SWAMP
Habitat	NatSub	Evenness of Natural Substrate Types
Habitat	PctBold_L	Percent Boulders - large
Habitat	PctBold_LS	Percent Boulders - large & small
Habitat	PctBold_S	Percent Boulders - small
Habitat	PctFin	Percent Fines
Habitat	PctFstH2O	Percent Fast Water of Reach
Habitat	PctGra	Percent Gravel - coarse
Habitat	PctSlwH2O	Percent Slow Water of Reach
Habitat	PctSmalSnd	Percent Substrate Smaller than Sand (<2 mm)
Habitat	PctSnd	Percent Sand
Habitat	ShD.AqHab	Shannon Diversity (H) of Aquatic Habitat Types
Habitat	ShD.NatSub	Shannon Diversity (H) of Natural Substrate Types

Variable Group	Variable Code	Description
Land Use	HDI	Combined Riparian Human Disturbance Index - SWAMP
Land use	PctImp	Percent Impervious Area of Reach
Land use	PctImp_1K	Percent Impervious Area in 1km
Land use	PctImp_5K	Percent Impervious Area in 5km
Land use	PctUrb	Percent Urban Area of Reach
Land use	PctUrb_1K	Percent Urban Area in 1km
Land use	PctUrb_5K	Percent Urban Area in 5km
Land use	RdCrs_5K	Number Road Crossings in 5km
Land use	RdCrs_W	Number Road Crossings in watershed
Land use	RdDen_1K	Road Density in 1km
Land use	RdDen_5K	Road Density in 5km
Land use	RdDen_W	Road Density in watershed
Land use	RoadCrs_1K	Number Road Crossings in 1km
Water Quality	AFDM.sub	Ash Free Dry Mass
Water Quality	Ammonia.sub	Ammonia
Water Quality	Chla.sub	Chlorophyll a
Water Quality	Chloride	Chloride
Water Quality	DO	Dissolved oxygen
Water Quality	Nitrate.sub	Nitrate
Water Quality	Nitrite.sub	Nitrite
Water Quality	OP.sub	Orthophosphate
Water Quality	pH	pH
Water Quality	Phosphorus.sub	Phosphorus
Water Quality	Silica	Silica
Water Quality	SpCond	Specific conductivity
Water Quality	Temp	Temperature
Water Quality	TKN.sub	Total Kjeldahl Nitrogen

Variable Group	Variable Code	Description
Water Quality	Total N	Total Nitrogen
Water Quality	UIA.sub	Unionized Ammonia

Table 1-B. Model and cross-validation statistics for random forest models with CSCI and D18 scores using the final set of model variables (Table 2, Table 3)

Index	Model Dataset	Model Statistic	
CSCI	Training	R ²	0.95
	Validation	R ²	0.61
CSCI	Training	CV R ²	0.66
	Validation	CV R ²	0.52
D18	Training	R ²	0.92
	Validation	R ²	0.34
D18	Training	CV R ²	0.35
	Validation	CV R ²	0.33

Training and validation models run with the same variables, *R² = adjusted R-squared, CV R² = Cross validation R²

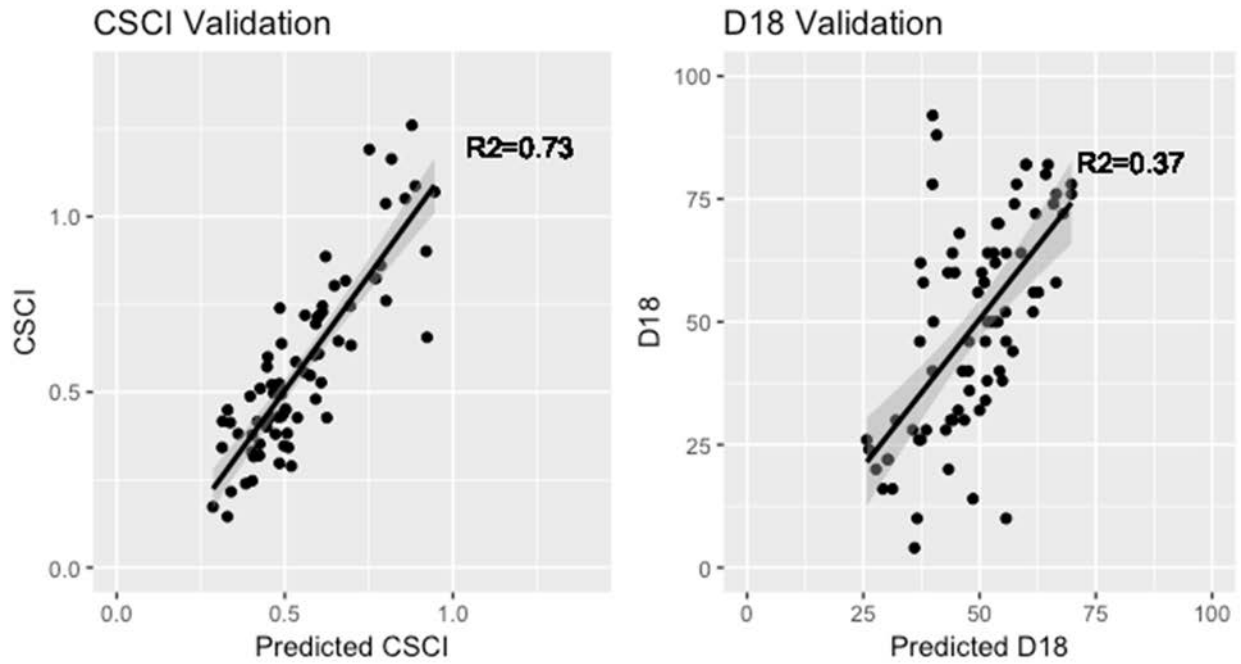

Figure 1-A. Relationship of observed to predicted CSCI and D18 scores in the validation dataset using all 49 explanatory variables in Step 1 of the random forest trial

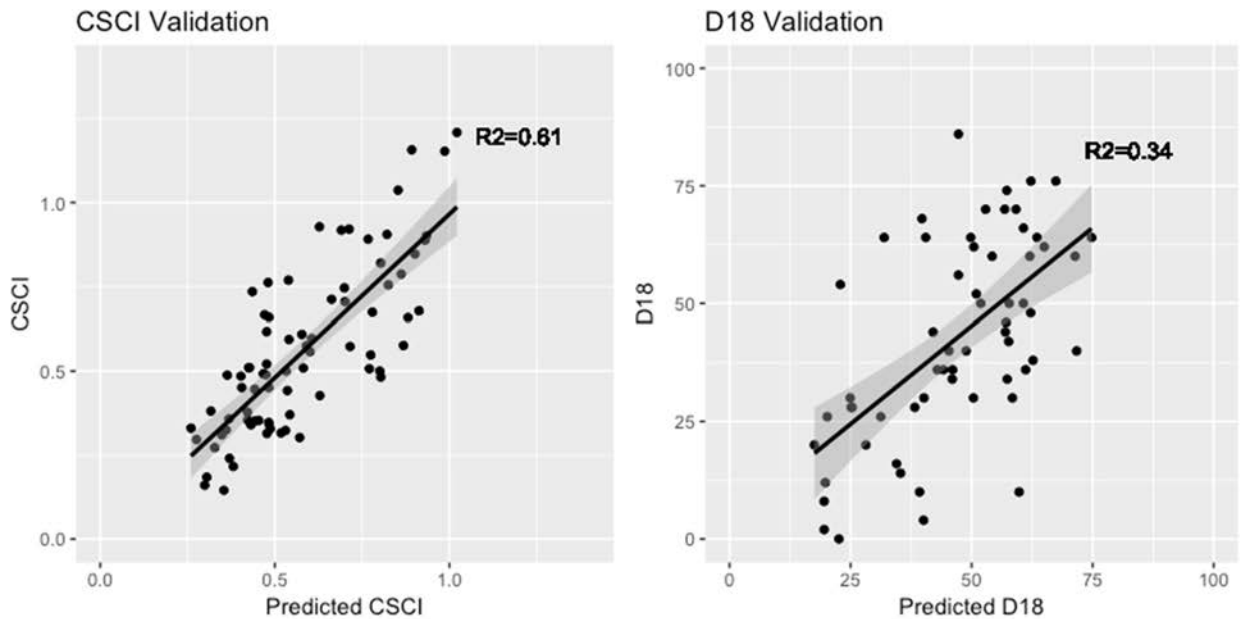

Figure 1-B. Relationship of observed to predicted CSCI and D18 scores in the validation dataset using the final, selected list of explanatory variables in Step 2 of the random forest trial

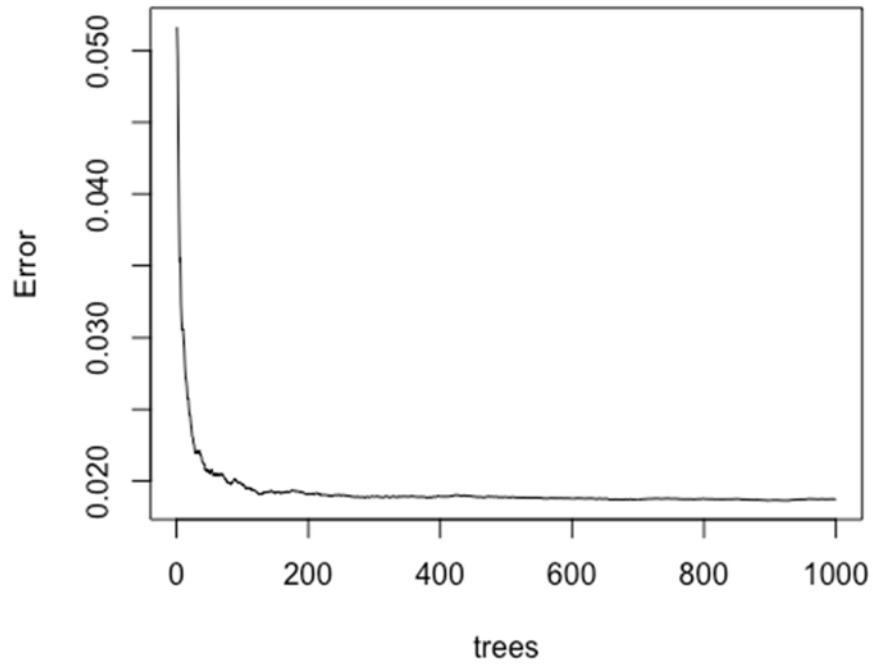

Figure 1-C. Prediction error vs. number of trees in the CSCI model with 49 stressor variables

APPENDIX 2 PARTIAL DEPENDENCY PLOTS

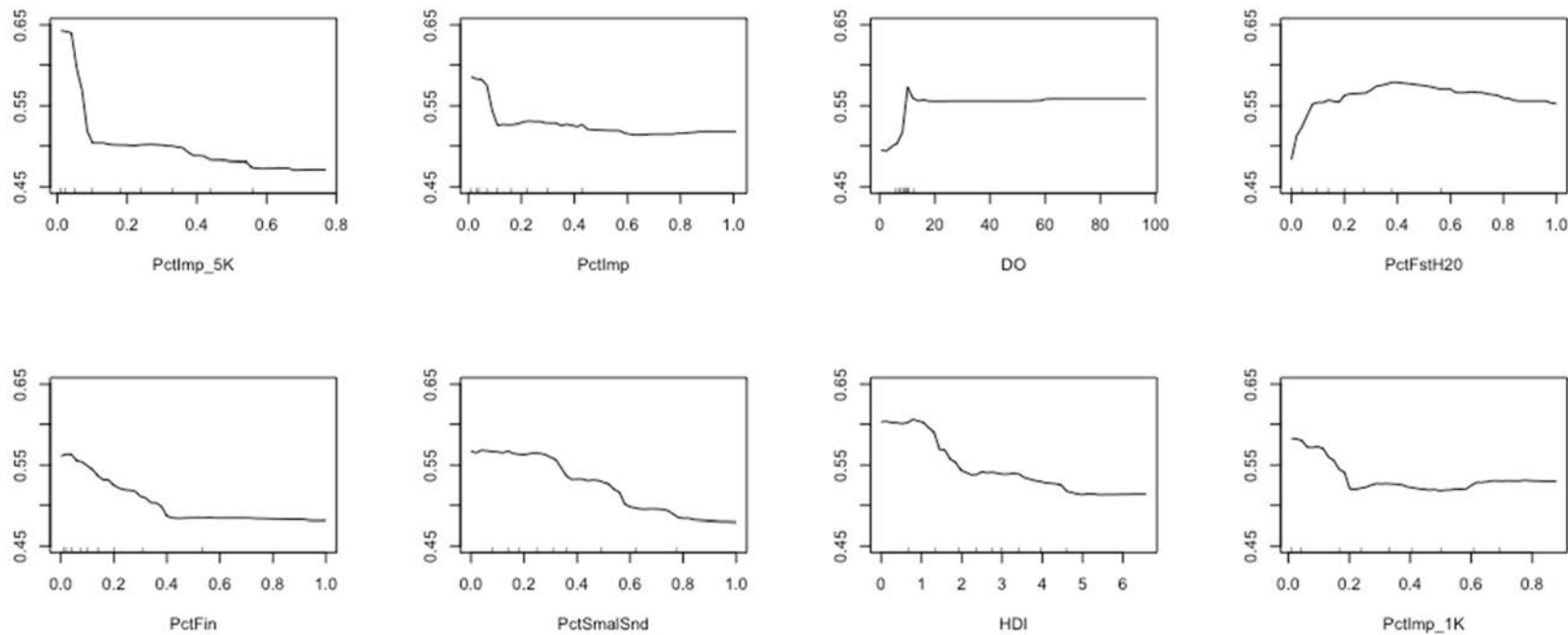

Figure 2-A. Partial dependency plots for stressor variables in random forest model of CSCI condition. Plots show the predicted response of CSCI (y-axis) based on the effect of individual explanatory variables (x-axis) with the response of all other variables removed in the training data set.

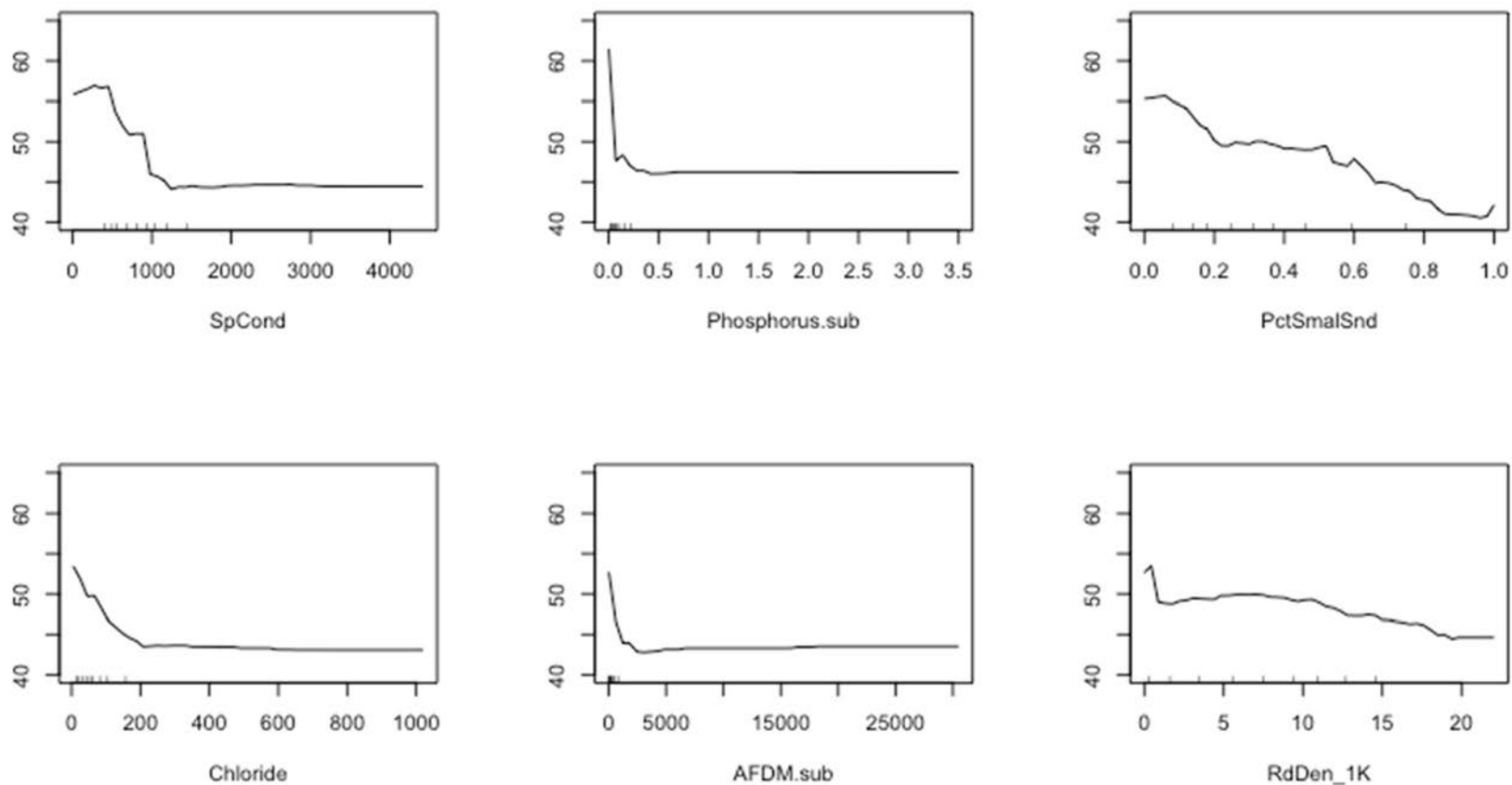

Figure 2-B. Partial dependency plots for stressor variables in random forest model of D18 condition. Plots show the predicted response of D18 (y-axis) based on the effect of individual explanatory variables (x-axis) with the response of all other variables removed in the training data set.

APPENDIX 3 CSCI-STRESSOR PLOTS

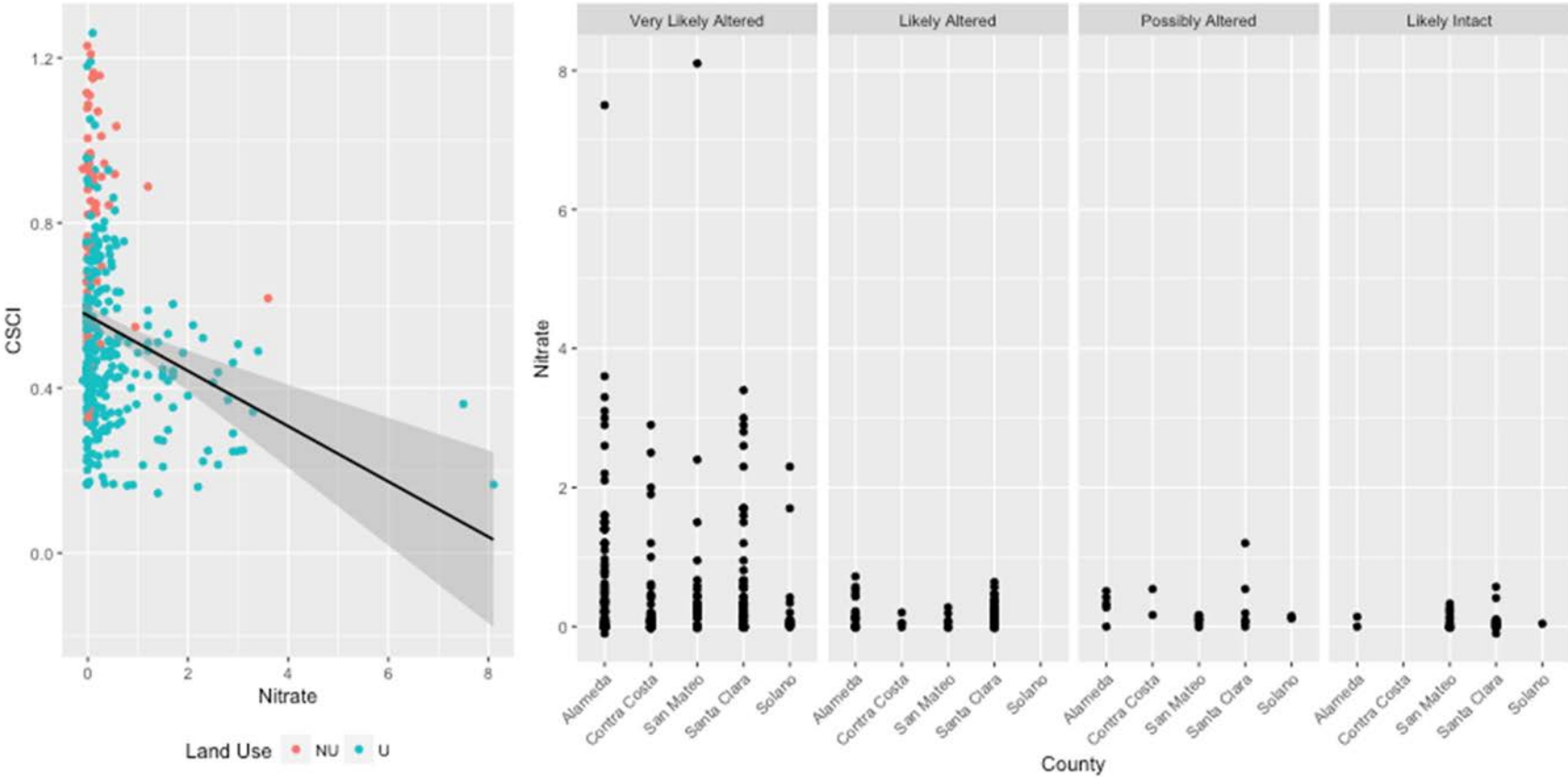

Figure 3-A. Relationship of Nitrate concentration to CSCI scores

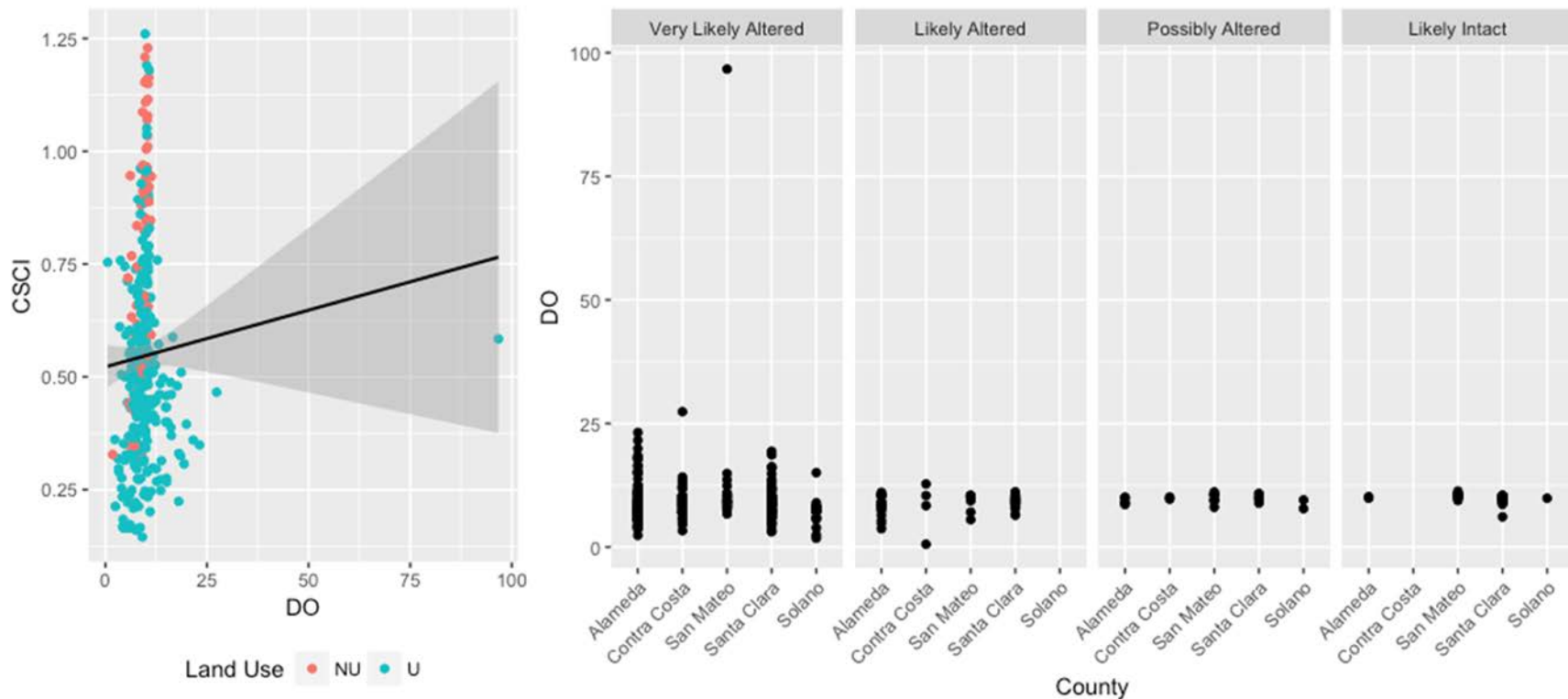

Figure 3-B. Relationship of Dissolved Oxygen values to CSCI scores

APPENDIX 4 ADDITIONAL FIGURES

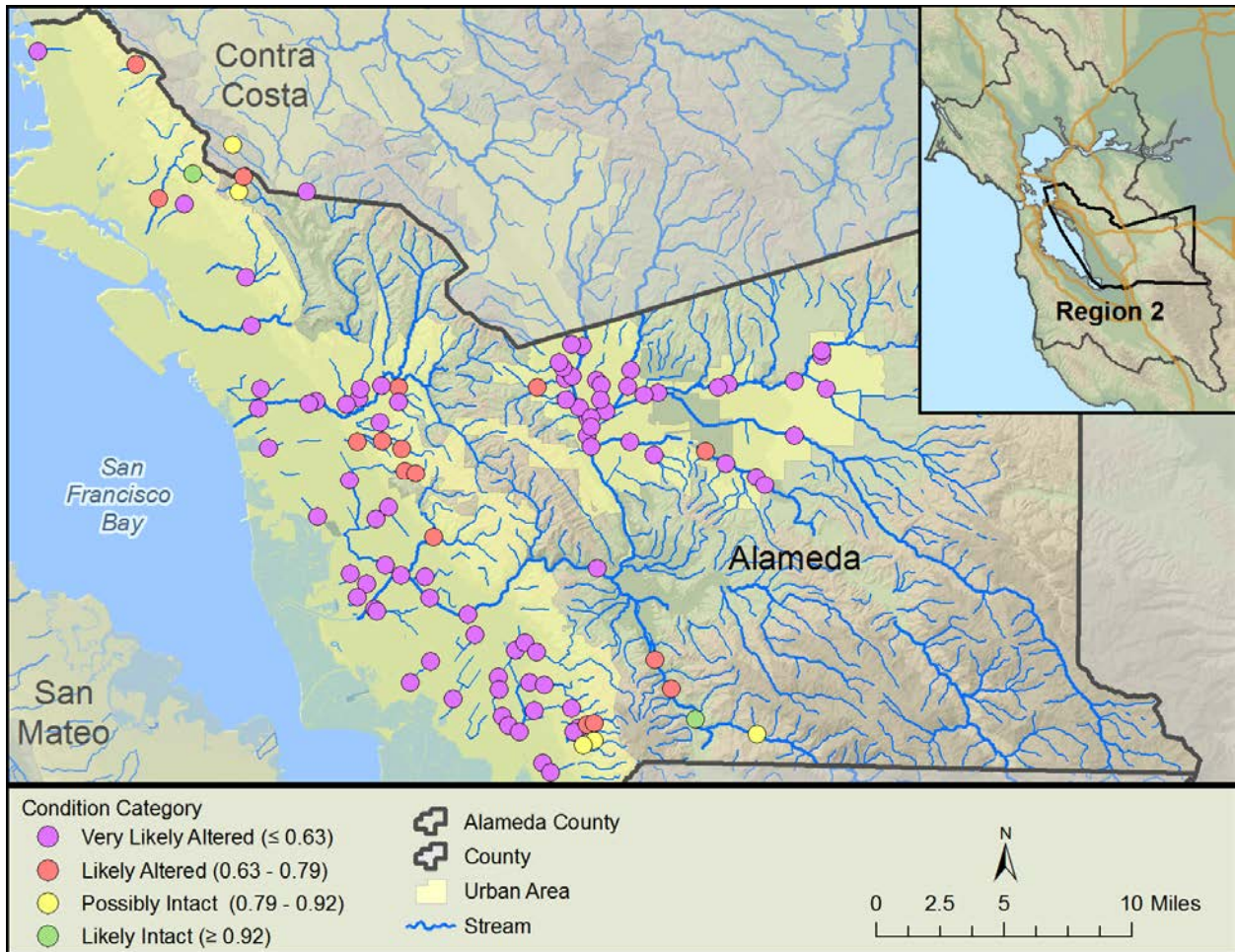

Figure 4-A. Biological condition based on CSCI scores in Alameda County.

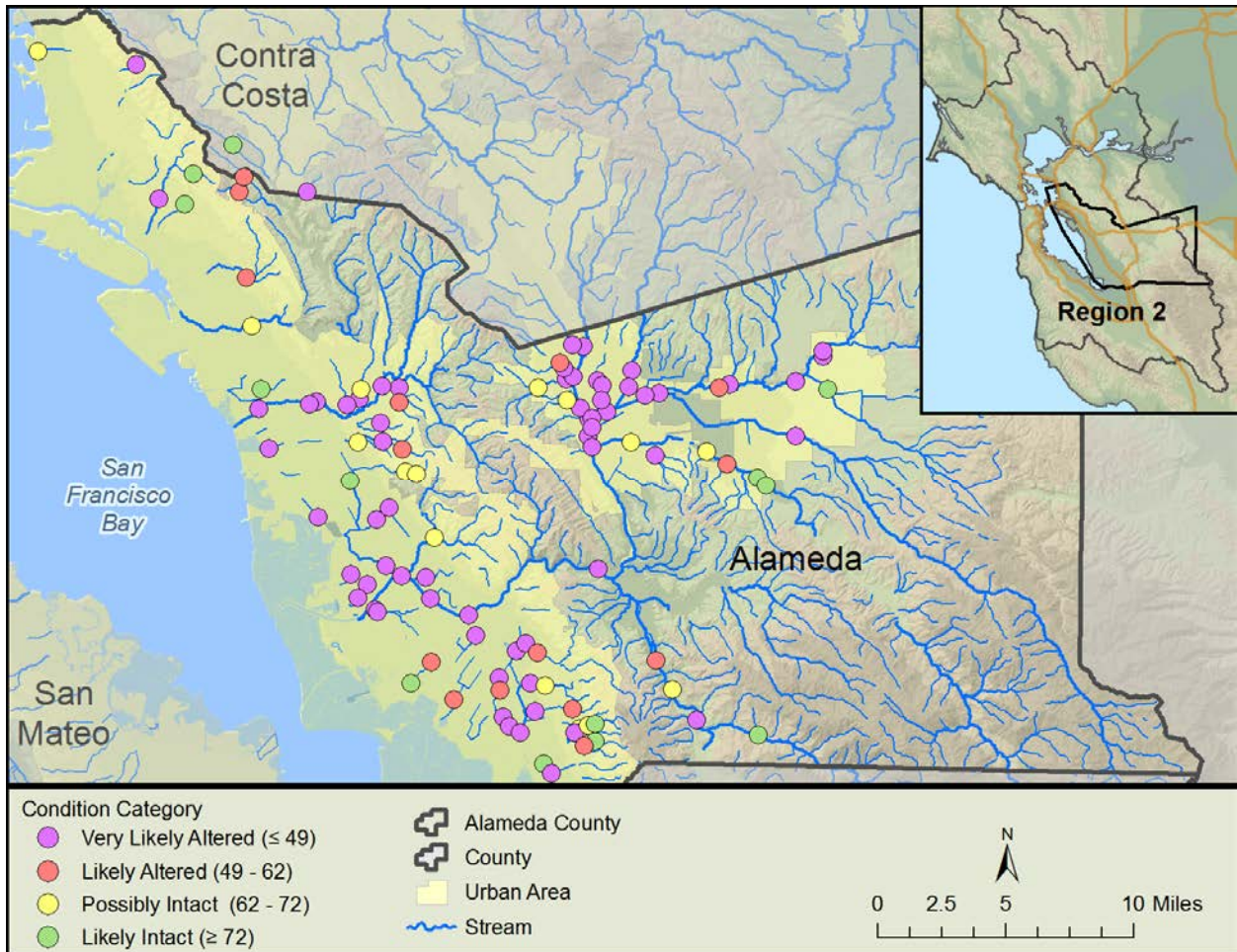

Figure4-B. Biological condition based on D18 scores in Alameda County.

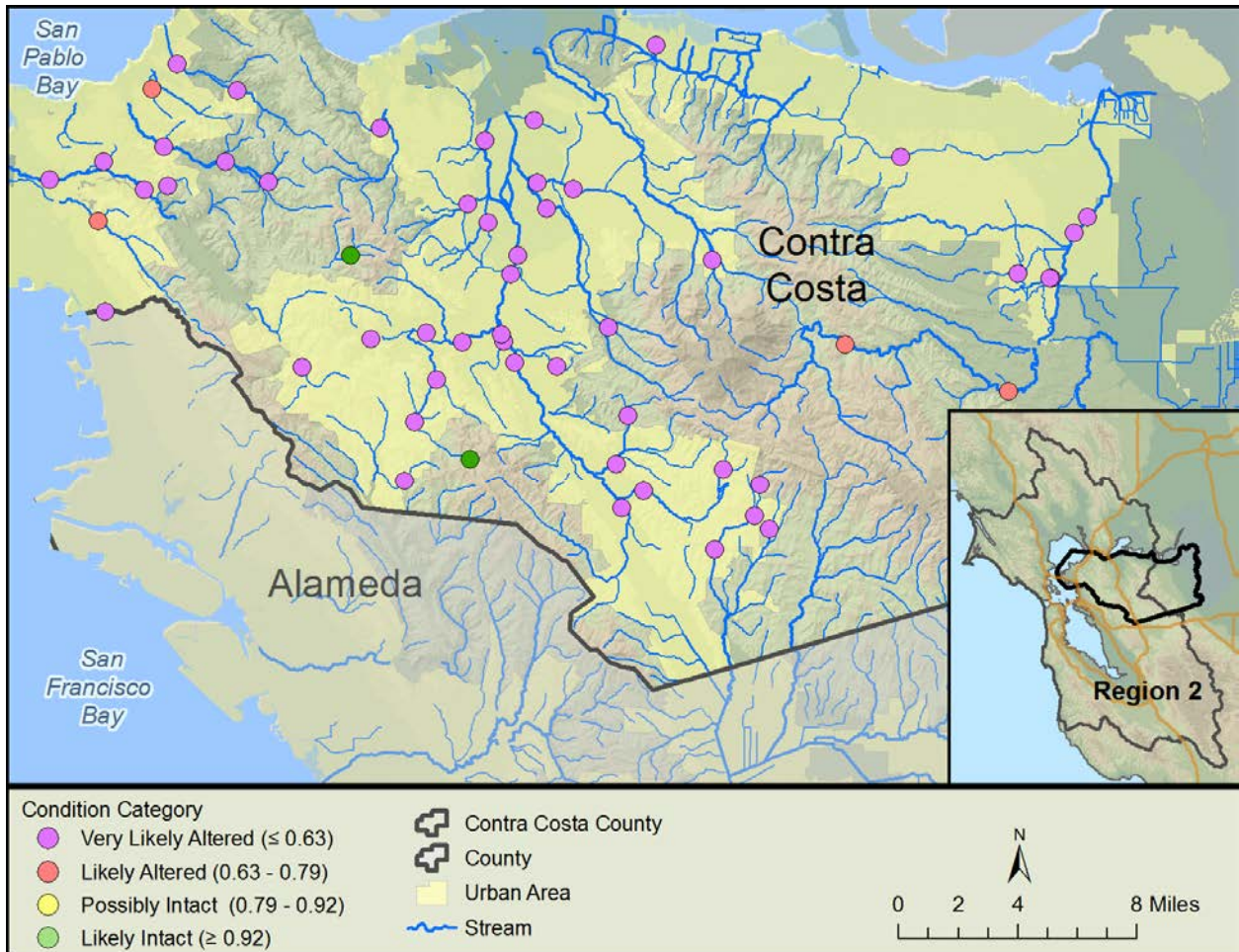

Figure 4-C. Biological condition based on CSCI scores in Contra Costa County.

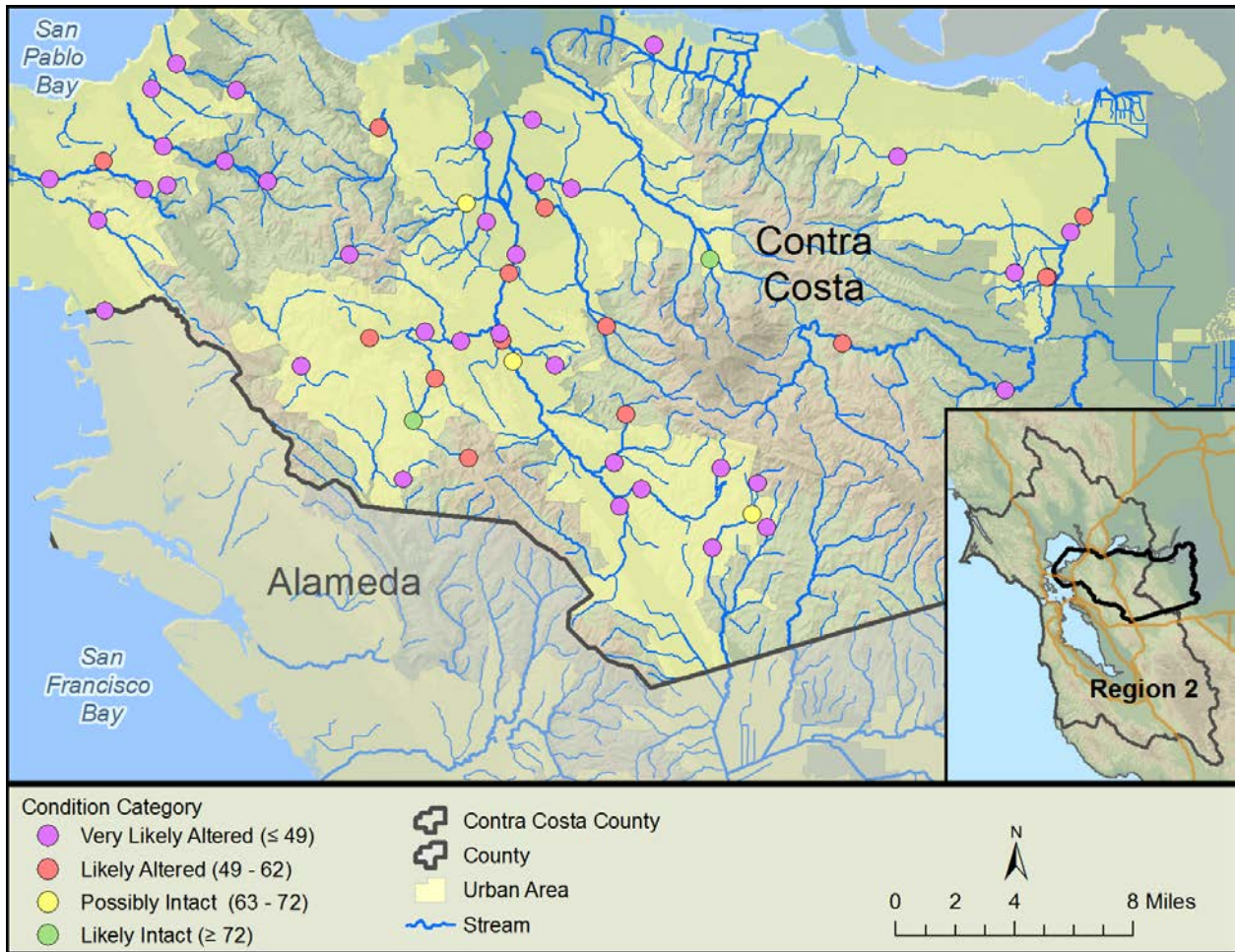

Figure 4-D. Biological condition based on D18 scores in Contra Costa County.



Figure 4-E. Biological condition based on CSCI scores in San Mateo County.

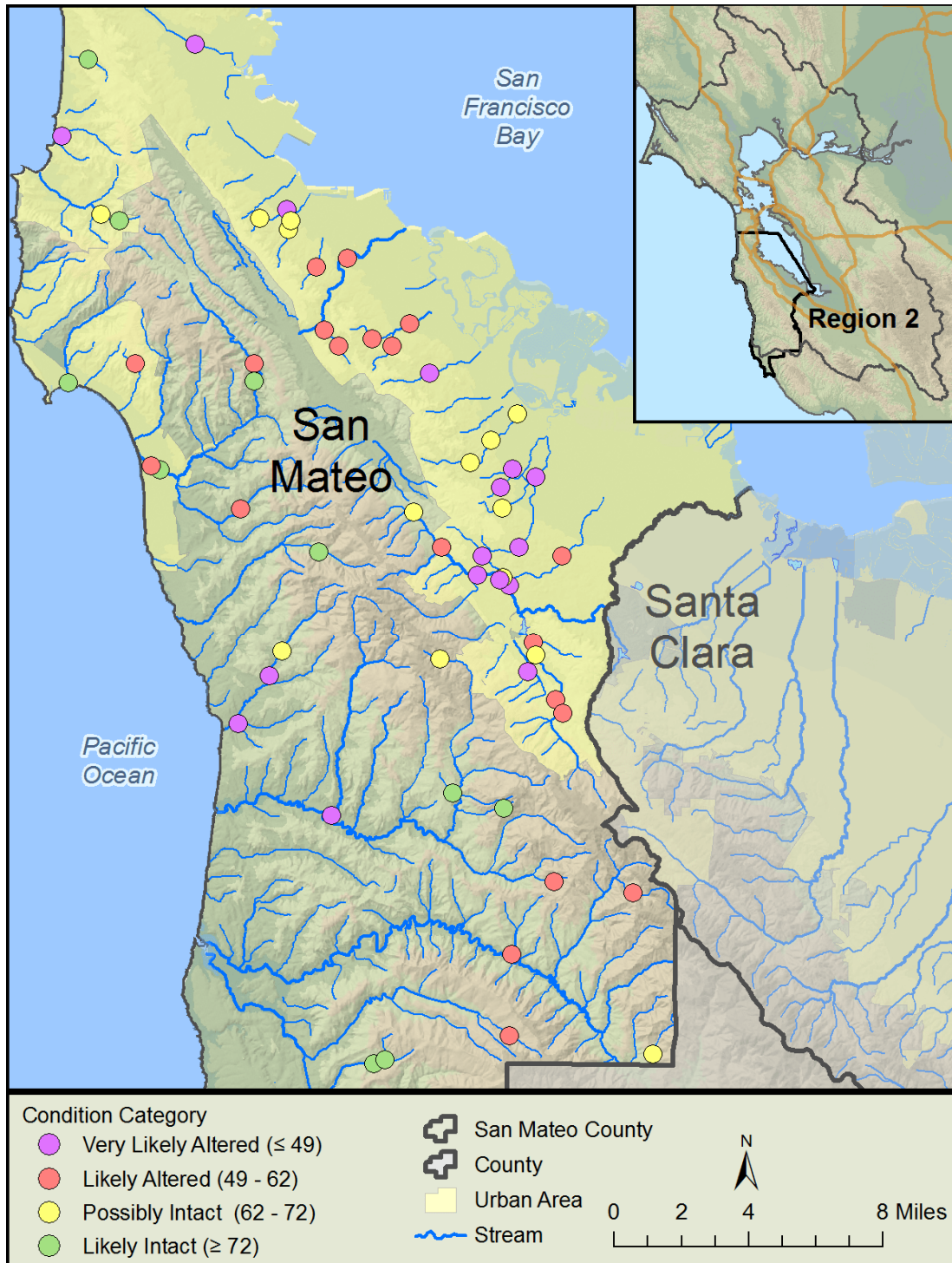

Figure 4-F. Biological condition based on D18 scores in San Mateo County.

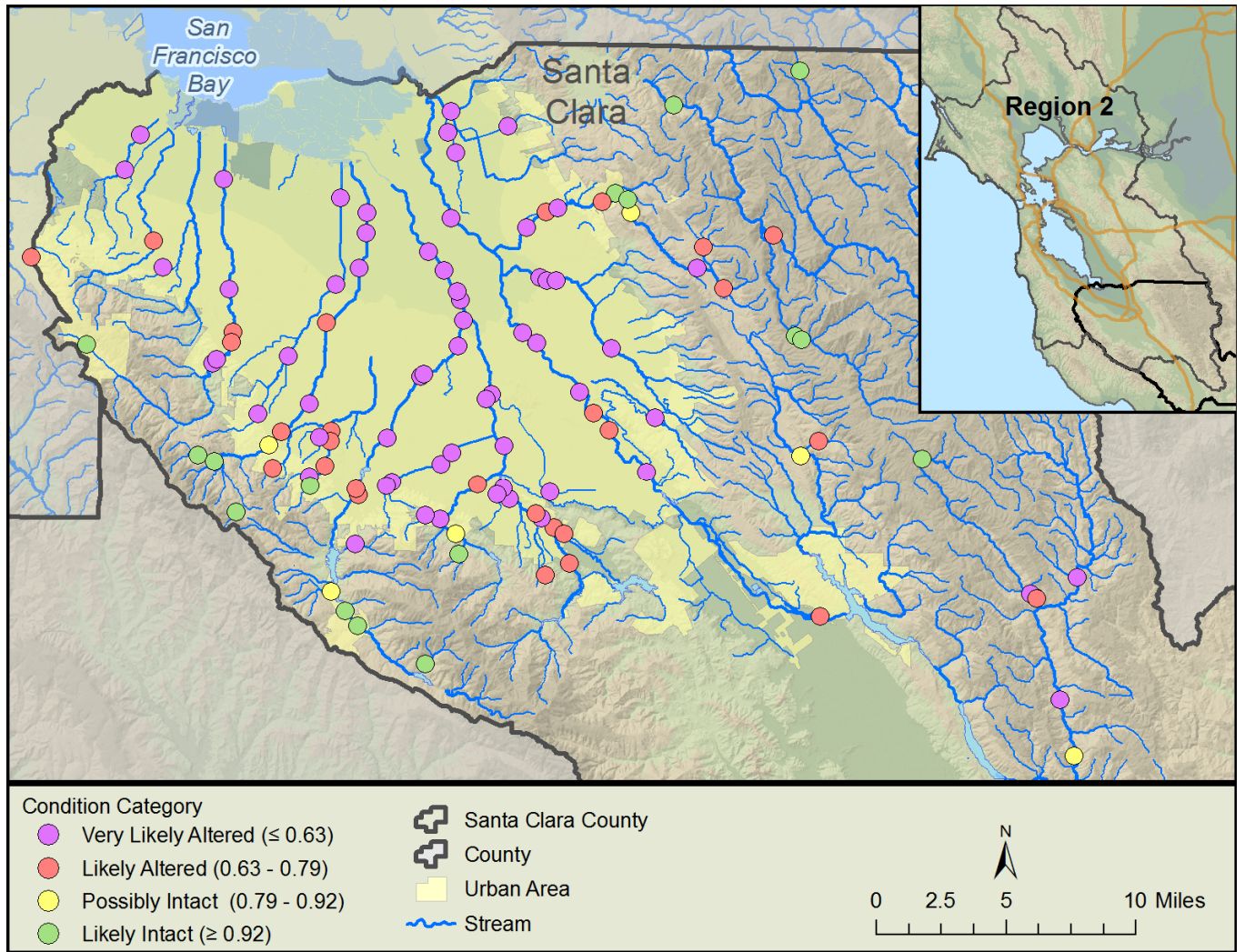

Figure 4-G. Biological condition based on CSCI scores in Santa Clara County.

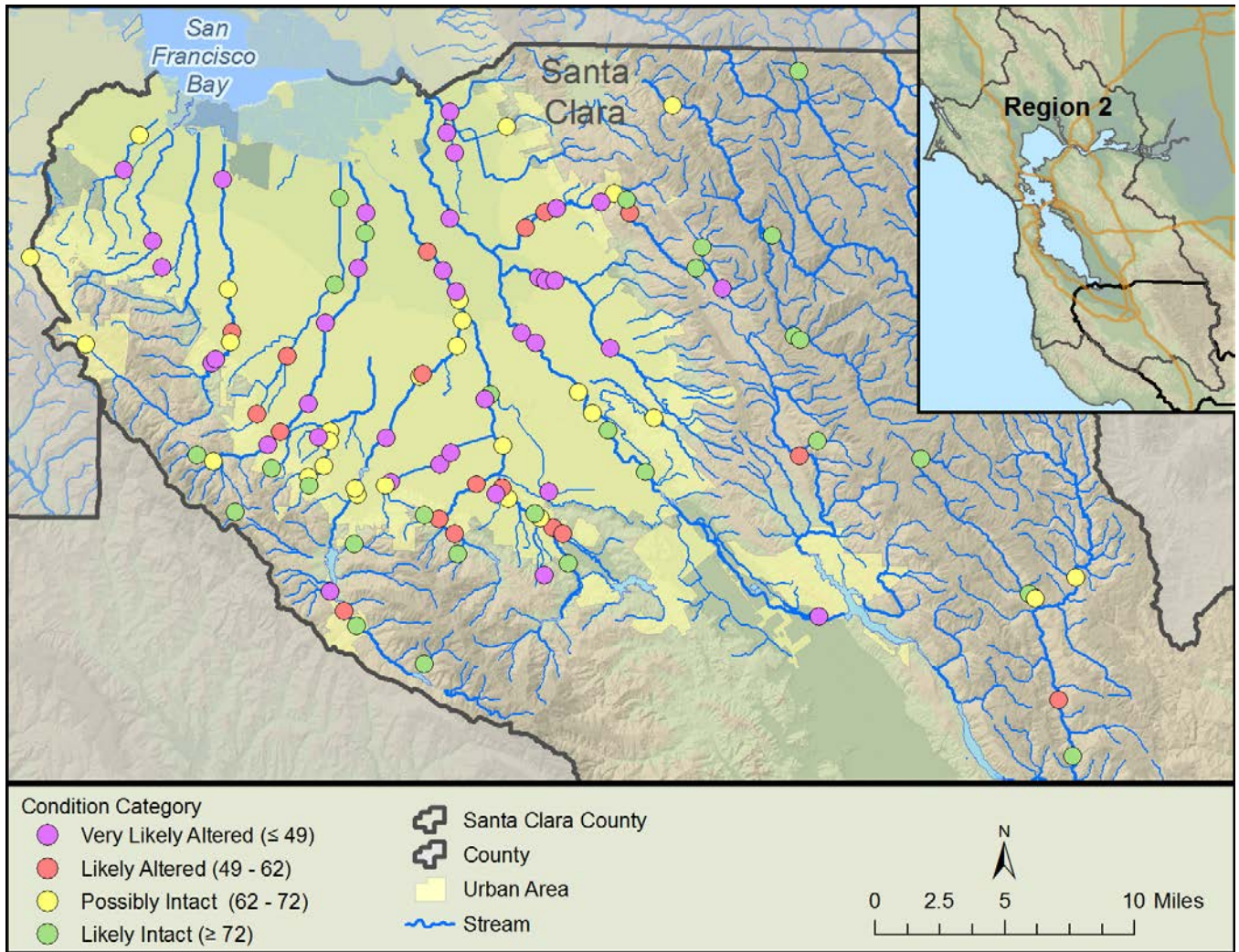

Figure 4-H. Biological condition based on D18 scores in Santa Clara County.

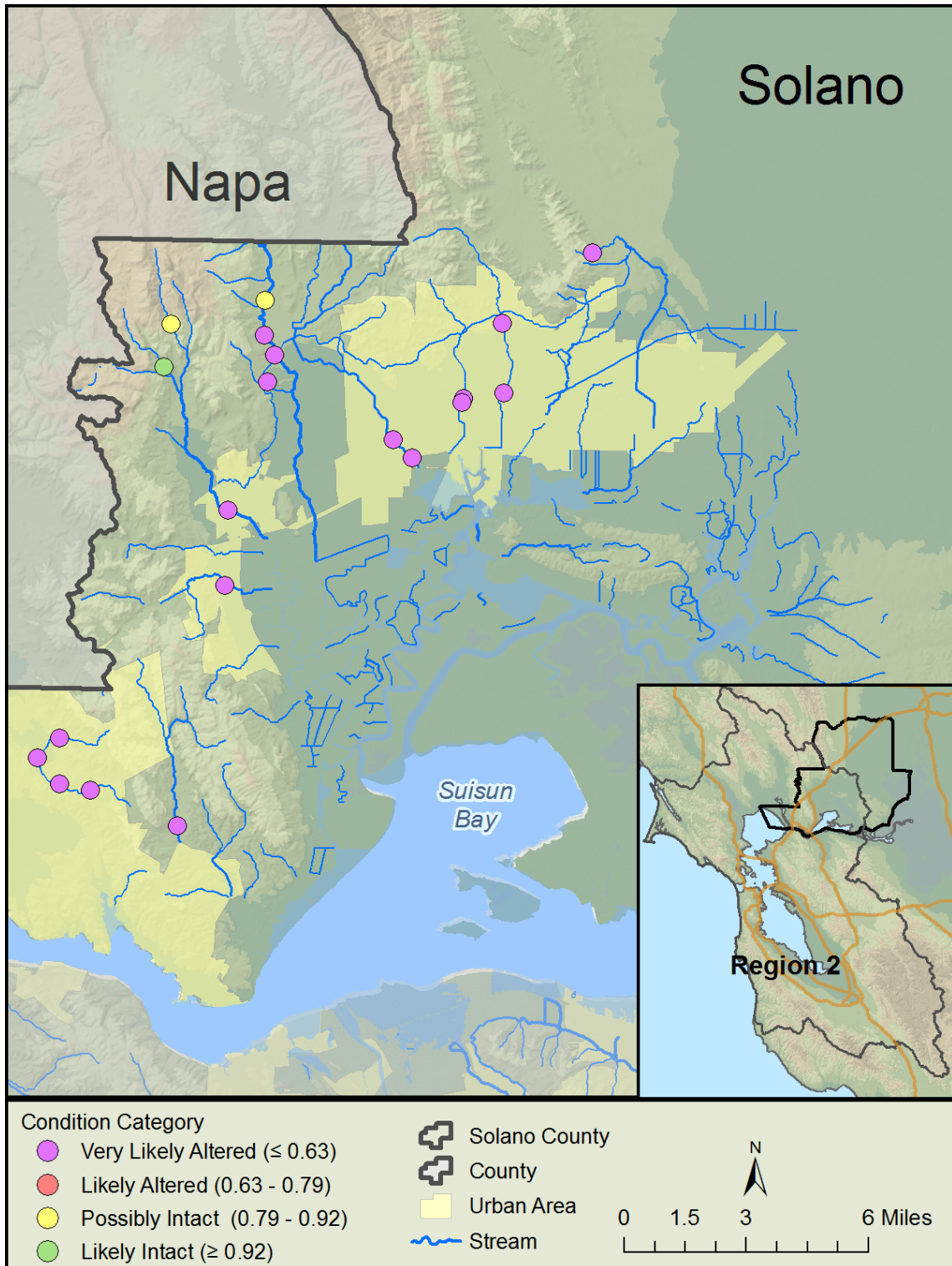

Figure 4-I. Biological condition based on CSCI scores in Solano County.

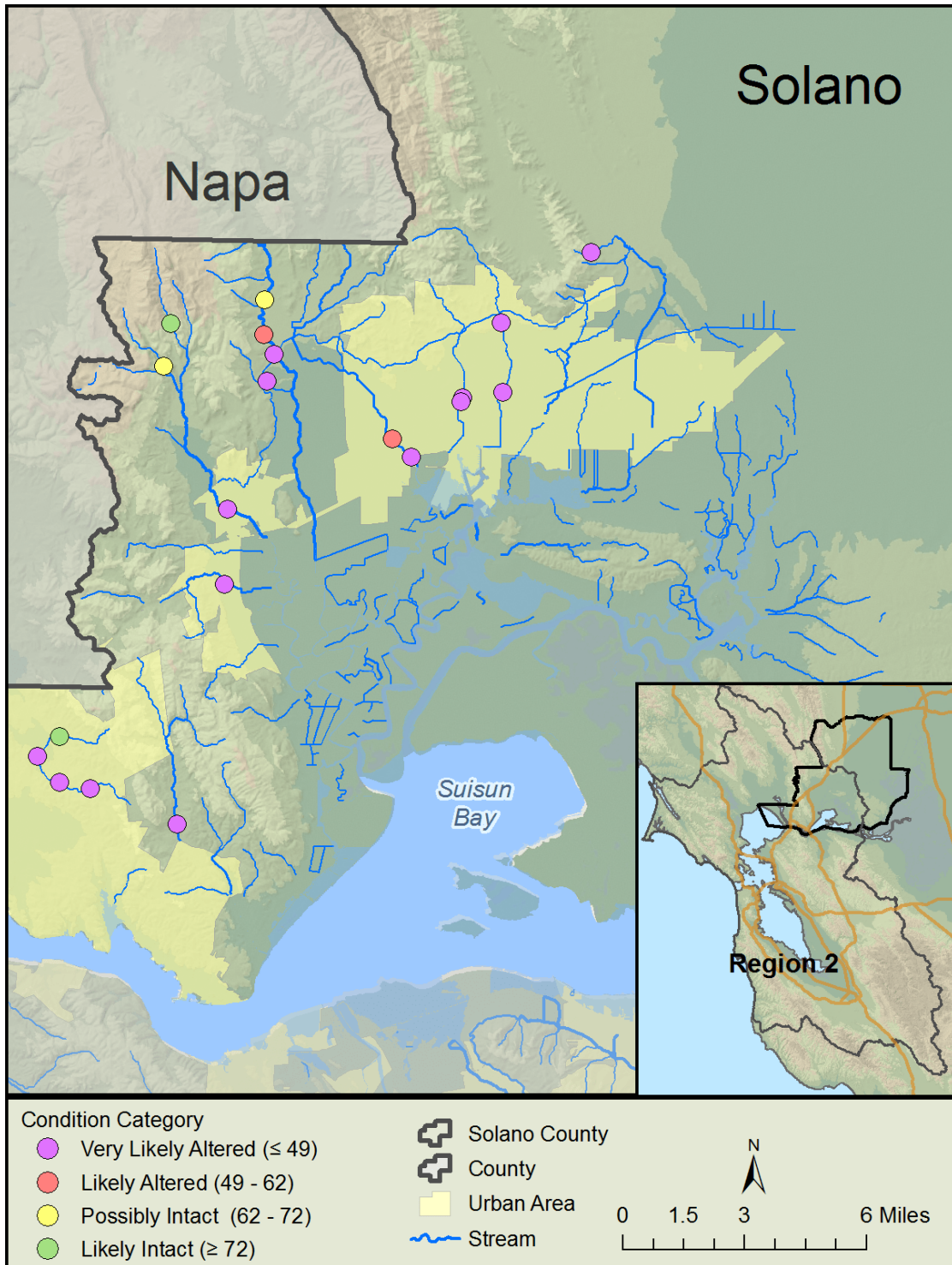

Figure 4-J. Biological condition based on D18 scores in Solano County.

