

APPENDIX A

REVISED TENTATIVE ORDER



Linda S. Adams
Secretary for Environmental
Protection

California Regional Water Quality Control Board

San Francisco Bay Region

1515 Clay Street, Suite 1400
(510) 622-2300 • Fax: (510) 622-2460
<http://www.waterboards.ca.gov/sanfranciscobay/>



Arnold Schwarzenegger
Governor

REVISED TENTATIVE ORDER NPDES NO. CA0037966

The following Discharger is authorized to discharge in accordance with the conditions set forth in this Order:

Discharger	City of Calistoga
Name of Facility	Dunaweal Wastewater Treatment Plant and its collection system
Facility Address	1185 Dunaweal Lane
	Calistoga, CA 94515
	Napa County

The Discharger is authorized to discharge from the following discharge points as set forth below:

Discharge Point	Effluent Description	Discharge Point Latitude	Discharge Point Longitude	Receiving Water
001	Tertiary treated	38° 33' 34" N	122° 33' 28" W	Napa River
002	Secondary treated	38° 34' 13" N	122° 33' 40" W	Napa River

This Order was adopted by the Regional Water Board on:	<Adoption date>
This Order shall become effective on:	December 1, 2006
This Order shall expire on:	February 28, 2010
The U.S. Environmental Protection Agency (USEPA) and the Regional Water Board have classified this discharge as a minor discharge.	
The Discharger shall file a Report of Waste Discharge in accordance with Title 23, California Code of Regulations, not later than 180 days in advance of the Order expiration date as application for issuance of new waste discharge requirements.	

IT IS HEREBY ORDERED, that Order No. 00-131 is rescinded upon the effective date of this Order except for enforcement purposes, and, in order to meet the provisions contained in Division 7 of the California Water Code (CWC) and regulations adopted thereunder, and the provisions of the federal Clean Water Act (CWA), and regulations and guidelines adopted thereunder, the Discharger shall comply with the requirements in this Order.

I, Bruce H. Wolfe, Executive Officer, do hereby certify the following is a full, true, and correct copy of an Order adopted by the California Regional Water Quality Control Board, San Francisco Bay Region, on <adoption date>.

Bruce H. Wolfe, Executive Officer

CALIFORNIA REGIONAL WATER QUALITY CONTROL BOARD

REGION 2, SAN FRANCISCO BAY REGION

REVISED TENTATIVE ORDER
NPDES NO. CA0037966

TABLE OF CONTENTS

I.	Facility Information.....	1
II.	Findings.....	2
III.	Discharge Prohibitions.....	6
IV.	Effluent Limitations and Discharge Specifications.....	7
	A. Final Effluent Limitations – Discharge Points 001 and 002.....	7
	B. Interim Effluent Limitations.....	11
V.	Receiving Water Limitations.....	13
VI.	Pond Effluent limitations.....	15
VII.	Provisions.....	15
	A. Standard Provisions.....	15
	B. Monitoring and Reporting Program Requirements.....	15
	C. Special Provisions.....	16
VIII.	Compliance Determination.....	30
	A. General.....	30
	B. Multiple Sample Data.....	30
	C. Average Monthly Effluent Limitation (AMEL).....	30
	D. Average Weekly Effluent Limitation (AWEL).....	30
	E. Maximum Daily Effluent Limitation (MDEL).....	31
	F. Instantaneous Minimum Effluent Limitation.....	31
	G. Instantaneous Maximum Effluent Limitation.....	31
	Attachment A – Definitions.....	A-1
	Attachment B (1) – Facility Location Map.....	B-1
	Attachment B (2) – Receiving Water Monitoring Station Map.....	B-1
	Attachment C – Flow Schematic.....	B-1
	Attachment D – Federal Standard Provisions.....	D-1
	Attachment E – Monitoring and Reporting Program (MRP).....	E-1
	Attachment F – Fact Sheet.....	F-1
	Attachment G – Regional Water Board Attachments.....	G-1

Limitations and Discharger Requirements - List of Tables

Table 1.	Receiving Water Body Beneficial Uses.....	3
Table 2.	Effluent Limitations for Conventional and Non-Conventional Pollutants for Discharge Point 001	7
Table 3.	Effluent Limitations for Conventional and Non-Conventional Pollutants for Discharge Point 002	7
Table 4.	Effluent Limitations for Mercury	10
Table 5.	Interim Effluent Limitations for Toxic Pollutants	11

I. FACILITY INFORMATION

The following Discharger is authorized to discharge in accordance with the conditions set forth in this Order:

Discharger	City of Calistoga
Name of Facility	Dunaweal Wastewater Treatment Plant and its collection system
Facility Address	1185 Dunaweal Lane
	Calistoga, CA 94515
	Napa County
Facility Contact, Title, and Phone	Paul Wade, Public Works Director, (707) 942-2828
Mailing Address	414 Washington Street, Calistoga, CA 94515
Type of Facility	POTW
Facility Design Flow	0.84 million gallons per day (MGD) average dry weather design flow

II. FINDINGS

The California Regional Water Quality Control Board, San Francisco Bay Region (hereinafter Regional Water Board), finds:

- A. **Background.** The City of Calistoga (hereinafter Discharger) is currently discharging under Order No. 00-131 and National Pollutant Discharge Elimination System (NPDES) Permit No. CA0037966. The Discharger submitted a Report of Waste Discharge, dated May 31, 2005, and applied for a NPDES permit renewal to discharge treated wastewater from City of Calistoga Dunaweal Wastewater Treatment Plant, hereinafter plant. The application was deemed complete on June 14, 2005.
- B. **Facility Description.** The Discharger owns and operates the plant which provides tertiary-level treatment for domestic, commercial, and some industrial wastewater from the City of Calistoga. The treatment processes consist of headworks, secondary treatment by activated sludge and clarification, tertiary treatment by coagulation and filtration, and disinfection. After secondary or tertiary treatment, the effluent may be discharged to the Napa River from November 1 through June 15. Treated wastewater is discharged to a non-tidal reach of the Napa River through two outfalls extending from the eastern bank of the river. Outfall 001 (see table on cover page) is used for discharging tertiary effluent. Outfall 002 is used only for discharging secondary effluent. During the remainder of the year, the wastewater is treated to tertiary standards, distributed for recycled water use, or stored for future use or disposal. The Discharger's wastewater collection system includes 12.7 miles of major sanitary sewer lines and various pump stations. **Attachment B(1)** provides a location map of the area around the plant. **Attachment C** provides a flow schematic of the plant.
- C. **Legal Authorities.** This Order is issued pursuant to section 402 of the Federal Clean Water Act (CWA) and implementing regulations adopted by the U.S. Environmental Protection Agency (USEPA) and Chapter 5.5, Division 7 of the California Water Code (CWC). It shall serve as an NPDES permit for point source discharges from this facility to surface waters.
- D. **Background and Rationale for Requirements.** The Regional Water Board developed the requirements in this Order based on information submitted as part of the application, through monitoring and reporting programs, and through special studies. **Attachments A through G**, which contain background information and rationale for Order requirements, are hereby incorporated into this Order and, thus, constitute part of the Findings for this Order.
- E. **California Environmental Quality Act (CEQA).** This action to adopt an NPDES permit is exempt from the provisions of the California Environmental Quality Act (Public Resources Code Section 21100, et seq.) in accordance with Section 13389 of the CWC.
- F. **Technology-Based Effluent Limitations.** The Code of Federal Regulations (CFR) at 40 CFR §122.44(a) requires that permits include applicable technology-based limitations and standards. This Order includes technology-based effluent limitations based on tertiary treatment or equivalent requirements that meet both the technology-based secondary treatment standards for

POTWs and protect the beneficial uses of the receiving waters. The Regional Water Board has considered the factors listed in CWC §13241 in establishing these requirements and/or Best Professional Judgment (BPJ) in accordance with 40 CFR §125.3. A detailed discussion of the technology-based effluent limitations development is included in the Fact Sheet (**Attachment F**).

- G. Water Quality-Based Effluent Limitations.** Section 122.44(d) of 40 CFR requires that permits include water quality-based effluent limitations (WQBELs) to attain and maintain applicable numeric and narrative water quality objectives/criteria (WQOs/WQC) to protect the beneficial uses of the receiving water. Where numeric water quality objectives have not been established, 40 CFR §122.44(d) specifies that WQBELs may be established using USEPA criteria guidance under CWA section 304(a), proposed State criteria or a State policy interpreting narrative criteria supplemented with other relevant information, or an indicator parameter.
- H. Water Quality Control Plan.** The Regional Water Board adopted a Water Quality Control Plan for the San Francisco Bay Basin (hereinafter Basin Plan) that designates beneficial uses, establishes water quality objectives, and contains implementation programs and policies to achieve those objectives for all waters addressed through the plan.

The applicable beneficial uses of the Napa River, in the vicinity of the discharge, are as listed in Table 1.

Table 1. Receiving Water Body Beneficial Uses

Discharge Point	Receiving Water Name	Beneficial Use(s)
001 and 002	Napa River	<ul style="list-style-type: none"> - Municipal and Domestic Water Supply - Agricultural Supply (AGR) - Navigation (NAV) - Water Contact Recreation (REC-1) - Non-contact Water Recreation (REC-2) - Wildlife Habitat (WILD) - Preservation of Rare and Endangered Species (RARE) - Fish Migration (MIGR) - Fish Spawning (SPWN) - Warm Freshwater Habitat (WARM) - Cold Freshwater Habitat (COLD)

Requirements of this Order specifically implement the Water Quality Control Plan.

- I. Thermal Plan.** The State Water Board adopted a *Water Quality Control Plan for Control of Temperature in the Coastal and Interstate Water and Enclosed Bays and Estuaries of California* (Thermal Plan) on May 18, 1972, and amended this plan on September 18, 1975. This plan contains temperature objectives for inland surface waters.

- J. **National Toxics Rule (NTR) and California Toxics Rule (CTR).** USEPA adopted the NTR on December 22, 1992, which was amended on May 4, 1995, and November 9, 1999. About forty criteria in the NTR applied in California. On May 18, 2000, USEPA adopted the CTR, which incorporated the NTR criteria that were applicable in California. The CTR was amended on February 13, 2001. These rules include water quality criteria (WQC) for priority pollutants and are applicable to this discharge.
- K. **State Implementation Policy.** On March 2, 2000, the State Water Board adopted the Policy for Implementation of Toxics Standards for Inland Surface Waters, Enclosed Bays, and Estuaries of California (State Implementation Policy or SIP). The SIP became effective on April 28, 2000, with respect to the priority pollutant criteria promulgated for California by the USEPA through the NTR and to the priority pollutant objectives established by the Regional Water Boards in their basin plans, with the exception of the provision on alternate test procedures for individual discharges that have been approved by USEPA Regional Administrator. The alternate test procedures provision was effective on May 22, 2000. The SIP became effective on May 18, 2000. The State Water Board subsequently amended the SIP on February 24, 2005, and the amendments became effective on July 31, 2005. The SIP includes procedures for determining the need for and calculating WQBELs and requires dischargers to submit data sufficient to do so. Requirements of this Order implement the SIP.
- L. **Compliance Schedules and Interim Requirements.** Section 2.1 of the SIP provides that, based on a discharger's request and demonstration that it is infeasible for an existing discharger to achieve immediate compliance with an effluent limitation derived from a CTR criterion, compliance schedules may be allowed in an NPDES permit. Unless an exception has been granted under Section 5.3 of the SIP, a compliance schedule may not exceed 5 years from the date that the permit is issued or reissued, nor may it extend beyond 10 years from the effective date of the SIP (or May 18, 2010) to establish and comply with CTR criterion-based effluent limitations. Where a compliance schedule for a final effluent limitation exceeds one year, the Order must include interim numeric limitations for that constituent or parameter. Where allowed by the Basin Plan, compliance schedules and interim effluent limitations or discharge specifications may also be granted to allow time to implement new or revised WQOs. This Order includes compliance schedules and interim effluent limitations. A detailed discussion of the basis for the compliance schedules and interim effluent limitations is included in the Fact Sheet (**Attachment F**).
- M. **Alaska Rule.** On March 30, 2000, USEPA revised its regulation that specifies when new and revised state and tribal water quality standards (WQS) become effective for CWA purposes. (40 C.F.R. § 131.21; 65 Fed. Reg. 24641 (April 27, 2000).) Under the revised regulation (also known as the Alaska rule), new and revised standards submitted to USEPA after May 30, 2000, must be approved by USEPA before being used for CWA purposes. The final rule also provides that standards already in effect and submitted to USEPA by May 30, 2000 may be used for CWA purposes, whether or not approved by USEPA.
- N. **Stringency of Requirements for Individual Pollutants.** This Order contains restrictions on individual pollutants that are no more stringent than required by the federal CWA. Individual

pollutant restrictions consist of technology-based restrictions and water quality-based effluent limitations. The technology-based effluent limitations consist of restrictions on CBOD, TSS, Oil and Grease, pH, and chlorine residual. Restrictions on these pollutants are specified in federal regulations, and in the Basin Plan since before May 30, 2000, as discussed in the attached Fact Sheet, **Attachment F**. The permit's technology-based pollutant restrictions are no more stringent than required by the CWA. Water quality-based effluent limitations have been scientifically derived to implement water quality objectives that protect beneficial uses. Both the beneficial uses and the water quality objectives have been approved pursuant to federal law and are the applicable federal water quality standards. To the extent that toxic pollutant water quality-based effluent limitations were derived from the CTR, the CTR is the applicable standard pursuant to section 131.38. The scientific procedures for calculating the individual water quality-based effluent limitations are based on the CTR-SIP, which was approved by USEPA on May 18, 2000. Most beneficial uses and water quality objectives contained in the Basin Plan were approved under state law and submitted to and approved by USEPA prior to May 30, 2000. Any water quality objectives and beneficial uses submitted to USEPA prior to May 30, 2000, but not approved by USEPA before that date, are nonetheless "applicable water quality standards for purposes of the CWA" pursuant to section 131.21(c)(1). The remaining water quality objectives and beneficial uses implemented by this Order (specifically Arsenic, Cadmium, Chromium (VI), Copper (fresh), Lead, Nickel, Silver (CMC), Zinc) were approved by USEPA on January 5, 2005, and are applicable water quality standards pursuant to section 131.21(c)(2). Collectively, this Order's restrictions on individual pollutants are no more stringent than required to implement the technology-based requirements of the CWA and the applicable water quality standards for purposes of the CWA.

- O. **Antidegradation Policy.** Section 131.12 of 40 CFR requires that State water quality standards include an antidegradation policy consistent with the federal policy. The State Water Board established California's antidegradation policy in State Water Board Resolution 68-16, which incorporates the requirements of the federal antidegradation policy. Resolution 68-16 requires that existing quality of waters be maintained unless degradation is justified based on specific findings. As discussed in detail in the Fact Sheet (**Attachment F**), the permitted discharge is consistent with the antidegradation provision of 40 CFR §131.12 and State Water Board Resolution 68-16.
- P. **Anti-Backsliding Requirements.** Sections 402(o)(2) and 303(d)(4) of the CWA and federal regulations at 40 CFR §122.44(1) prohibit backsliding in NPDES permits. These anti-backsliding provisions require effluent limitations in a reissued permit to be as stringent as those in the previous permit, with some exceptions where limitations may be relaxed. Some effluent limitations in this Order are less stringent than those in the previous Order. As discussed in detail in the Fact Sheet (**Attachment F**), this relaxation of effluent limitations is consistent with the anti-backsliding requirements of the CWA and federal regulations.
- Q. **Monitoring and Reporting.** Section 122.48 of 40 CFR requires that all NPDES permits specify requirements for recording and reporting monitoring results. Sections 13267 and 13383 of the CWA authorize the Regional Water Boards to require technical and monitoring reports. The Monitoring and Reporting Program (MRP) establishes monitoring and reporting requirements to

implement federal and State requirements. This MRP is provided in **Attachment E**. The MRP may be amended by the Executive Officer pursuant to USEPA regulation 40 CFR 122.62, 122.63, and 124.5.

- R. **Standard and Special Provisions.** Standard Provisions, which in accordance with 40 CFR §§122.41 and 122.42, apply to all NPDES discharges and must be included in every NPDES permit, are provided in **Attachment D**. The Regional Water Board has also included in this Order special provisions applicable to the Discharger. A rationale for the special provisions contained in this Order is provided in the attached Fact Sheet (**Attachment F**).
- S. **Notification of Interested Parties.** The Regional Water Board has notified the Discharger and interested agencies and persons of its intent to prescribe Waste Discharge Requirements for the discharge and has provided them with an opportunity to submit their written comments and recommendations. Details of notification are provided in the Fact Sheet (**Attachment F**).
- T. **Consideration of Public Comment.** The Regional Water Board, in a public meeting, heard and considered all comments pertaining to the discharge. Details of the Public Hearing are provided in the Fact Sheet (**Attachment F**).

III. DISCHARGE PROHIBITIONS

- A. Discharge of wastewater at a different location or in a different manner than those described in this Order is prohibited. Discharge from Outfall 001 to receiving water at any point where it does not receive a minimum initial dilution of 10 to 1 (10:1), river to wastewater flow, is prohibited. Discharge of wastewater from Outfall 002 to receiving water at any point where it does not receive a minimum initial dilution of 50 to 1 (50:1), river to wastewater flow, is prohibited. This minimum river to wastewater flow ratio must be verified by field measurements at the Plant.
- B. The bypass of untreated or partially treated wastewater to waters of the United States is prohibited, except as provided for in the conditions stated in 40 CFR 122.41(m)(4) and in A.13 of the *Standard Provisions and Reporting Requirements for NPDES Surface Water Discharge Permits, August 1993* (**Attachment G**).
- C. Average dry weather flow from the treatment plant greater than 0.84 MGD is prohibited. Average dry weather flow shall be determined over a period of three consecutive dry weather months each year.
- D. Discharge to the Napa River is prohibited during the period from June 16 through October 31 of each year. Discharge to the Napa River prior to October 31 or later than June 15 may be authorized by the Executive Officer, when the conditions specified in Provision VII.C.7 are satisfied.
- E. Wastewater with an elevated temperature discharged into a receiving water that supports cold fresh water habitat is prohibited, unless it can be demonstrated to the satisfaction of the Regional

Water Board that such an alteration of temperature does not adversely affect the beneficial uses of the receiving water.

- F. Any sanitary sewer overflow that results in a discharge of untreated or partially treated wastewater to waters of the United States is prohibited.

IV. EFFLUENT LIMITATIONS AND DISCHARGE SPECIFICATIONS

A. Final Effluent Limitations – Discharge Points 001 and 002

1. BOD, TSS, Oil and Grease, and Turbidity

The discharge of treated wastewater shall maintain compliance with the effluent limitations for the above pollutants as specified in Tables 2 and 3 below, at Discharge Points 001 and 002, with compliance measured at Monitoring Locations M-001 and M-002, respectively, as described in the attached Monitoring and Reporting Program (**Attachment E**):

a. Discharge Point 001

Table 2. Effluent Limitations for Conventional Pollutants for Discharge Point 001

Parameter	Units	Effluent Limitations				
		Average Monthly	Average Weekly	Maximum Daily	Instantaneous Minimum	Instantaneous Maximum
Biochemical Oxygen Demand 5-day @ 20°C	mg/L	10	15	--	--	--
Total Suspended Solids	mg/L	15	20	--	--	--
Oil and Grease	mg/L	5	--	10	--	--
Turbidity	NTU	--	--	10	--	--

b. Discharge Point 002

Table 3. Effluent Limitations for Conventional Pollutants for Discharge Point 002

Parameter	Units	Effluent Limitations				
		Average Monthly	Average Weekly	Maximum Daily	Instantaneous Minimum	Instantaneous Maximum
Biochemical Oxygen Demand 5-day @ 20°C	mg/L	30	45	--	--	--
Total Suspended Solids	mg/L	30	45	--	--	--
Oil and Grease	mg/L	10	--	20	--	--

2. BOD and TSS Percent Removal

The arithmetic mean of the BOD (Five-day, 20°C) and total suspended solids values, by concentration, for effluent samples collected in each calendar month shall not exceed 15 percent of the arithmetic mean of the respective values for influent samples collected at approximately the same times during the same period.

3. pH

The pH of the effluent shall not be less than 6.5 nor greater than 8.5 ⁽¹⁾.

(1) The Discharger may elect to use a continuous on-line monitoring system(s) for measuring pH. If the Discharger employs continuous monitoring, then the Discharger shall be in compliance with the pH limitation specified herein, provided that both of the following conditions are satisfied:

- (i) The total time during which the pH values are outside the required range of pH values shall not exceed 7 hours and 26 minutes in any calendar month; and
- (ii) No individual excursion from the range of pH values shall exceed 60 minutes.

4. Coliform Bacteria

The treated wastewater, at some point in the treatment process prior to discharge, shall meet the following limits of bacteriological quality:

- a. The moving median value for the most probable number (MPN) of total coliform bacteria in any five consecutive samples shall not exceed 23 MPN/100 mL; and
- b. Any single sample shall not exceed 240 MPN/100 mL.

5. Chlorine Residual

The effluent shall not contain a residual chlorine concentration greater than 0.0 mg/L at any time. This concentration limit is defined as below the limit of detection in standard test methods defined in the latest USEPA approved edition of *Standard Methods for the Examination of Water and Wastewater*. The Discharger may elect to use a continuous on-line monitoring system(s) for measuring flows, chlorine residual and sodium bisulfite (or other dechlorinating chemical) dosage (including a safety factor) and concentration to prove that chlorine residual exceedances are false positives. If convincing evidence is provided, Regional Water Board staff may conclude that these false positive chlorine residual exceedances are not violations of this permit limitation.

6. Whole Effluent Acute Toxicity

- a. Representative samples of the discharge shall meet the following limitations for acute toxicity. Bioassays shall be conducted in compliance with Section V.A of the Monitoring and Reporting Program (MRP, **Attachment E**).
 - i) The survival of organisms in the undiluted effluent shall be at least 70 percent in each bioassay.
 - ii) The survival of the 3-sample moving median value shall be at least 90 percent.
- b. These acute toxicity limitations are further defined as follows:

3-sample median: Any bioassay test showing survival of 90 percent or greater is not a violation of this limit. A bioassay test showing survival of less than 90 percent represents a violation of this effluent limit if one or more of the past two or less bioassay tests show less than 90 percent survival.

- c. Bioassays shall be performed using the most up-to-date USEPA protocol and the most sensitive species as specified in writing by the Executive Officer based on the most recent screening test results. Bioassays shall be conducted in compliance with “Methods for Measuring the Acute Toxicity of Effluents and Receiving Water to Freshwater and Marine Organisms,” currently 5th Edition (EPA-821-R-02-012), with exceptions granted to the Discharger by the Executive Officer and the Environmental Laboratory Accreditation Program (ELAP) upon the Discharger’s request with justification.
- d. If the Discharger can demonstrate to the satisfaction of the Executive Officer that toxicity exceeding the levels cited above is caused by ammonia and that the ammonia in the discharge is not adversely impacting receiving water quality or beneficial uses, then such toxicity does not constitute a violation of this effluent limitation.

7. Whole Effluent Chronic Toxicity

- a. Compliance with the Basin Plan narrative toxicity objective shall be demonstrated according to the following tiered requirements based on results from representative samples of the treated effluent meeting test acceptability criteria and Section V.B of the MRP (**Attachment E**):
 - 1) Conduct routine monitoring;
 - 2) Accelerate monitoring after exceeding a single sample maximum value of 10 TUC¹ (this requirement is interim; see 7.c. below).

¹ A TUC equals 100 divided by the no observable effect level (NOEL). The NOEL is determined from IC, EC, or NOEC values. These terms, their usage, and other chronic toxicity monitoring program

- 3) Return to routine monitoring if accelerated monitoring does not exceed the “trigger” in (2);
 - 4) Initiate approved Toxicity Reduction Evaluation (TRE) work plan and continue accelerated monitoring if monitoring confirms consistent toxicity above the “trigger” in (2);
 - 5) Return to routine monitoring after appropriate elements of TRE work plan are implemented and toxicity drops below the “trigger” level in (2), or as directed by the Executive Officer.
- b. *Test Species and Methods:* The Discharger shall conduct routine monitoring with the most sensitive species determined during the most recent chronic toxicity screening performed by the Discharger and approved by the Executive Officer. Chronic Toxicity Monitoring Screening Phase Requirements, Critical Life Stage Toxicity Tests and definitions of terms used in the chronic toxicity monitoring are identified in **Appendices E-1 and E-2** of the MRP (**Attachment E**). In addition, bioassays shall be conducted in compliance with the most recently promulgated test methods, “Short-term Methods for Estimating the Chronic Toxicity of Effluents and Receiving Waters to Freshwater Organisms,” currently fourth Edition (EPA-821-R-02-013), with exceptions granted by the Executive Officer and the Environmental Laboratory Accreditation Program (ELAP).
- c. The interim requirement in 7.a.(2) above shall become final if a diffuser is installed. If a diffuser is not installed, final requirements will be determined for the next permit reissuance after an appropriate dilution credit is demonstrated under Provision VII.C.2.d.

8. Toxic Pollutants Effluent Limitations

The discharge of treated wastewater shall maintain compliance with the effluent limitations for mercury as specified in Table 4 below at Discharge Points 001 and 002, with compliance measured at Monitoring Locations M-001 or M-002 as described in the attached Monitoring and Reporting Program (**Attachment E**):

Table 4. Effluent Limitations for Mercury [1]

Parameter	Units	Final Effluent Limitations	
		AMEL	MDEL
Mercury	µg/L	0.020	0.042

requirements are defined in more detail in the MRP (**Attachment E**). Monitoring and TRE requirements may be modified by the Executive Officer in response to the degree of toxicity detected in the effluent or in ambient waters related to the discharge.

Footnote for Table 4:

- [1] a. Effluent mercury monitoring shall be performed using ultra-clean sampling and analysis techniques, with a method detection limit of 0.0002 µg/L or lower (or a minimum level [ML] of 0.0005 µg/L or lower).
- b. Limitations apply to the average concentration of all samples collected during the averaging period (daily = 24-hour period; monthly = calendar month).
- c. The limitations are total recoverable.

B. Interim Effluent Limitations

1. Interim Effluent Limitations for Toxic Pollutants

The discharge shall maintain compliance with the interim limitations specified in Table 5 below at 001 and 002 with compliance measured at Monitoring Locations M-001 or M-002 as described in the attached MRP (**Attachment E**).

Table 5. Interim Effluent Limitations for Toxic Pollutants [1][2]

Parameter	Units	Interim Effluent Limitations (Daily Maximum)
Copper [3]	µg/L	14.7
Cyanide [3][4]	µg/L	21.6
Chlorodibromomethane [3]	µg/L	9.6
Dichlorobromomethane [3]	µg/L	23

Footnote for Table 5:

- [1] a. All analyses shall be performed using current USEPA methods, or equivalent methods approved in writing by the Executive Officer.
 - b. Limitations apply to the average concentration of all samples collected during the averaging period (daily = 24-hour period; monthly = calendar month).
 - c. All metal limitations are total recoverable.
- [2] A daily maximum or average monthly value for a given constituent shall be considered noncompliant with the effluent limitations only if it exceeds the effluent limitation and the Reporting Level for that constituent. As outlined in Section 2.4.5 of the SIP, the table below indicates the Minimum Level (ML) upon which the Reporting Level is based for compliance determination purposes. A Minimum Level is the concentration at which the entire analytical system must give a recognizable signal and acceptable calibration point. The ML is the concentration in a sample that is equivalent to the concentration of the lowest calibration standard analyzed by a specific analytical procedure, assuming that all the method specified sample weights, volumes, and processing steps have been followed.

Constituent	ML (µg/L)
Copper	2
Cyanide	5
Chlorodibromomethane	0.5
Dichlorobromomethane	0.5

[3] The interim limitations for copper, chlorodibromomethane, and dichlorobromomethane shall remain in effect until May 17, 2010, and for cyanide until April 27, 2010, or until the Regional Water Board amends the limitations based on SSOs and/or additional information.

[4] Compliance may be demonstrated by measurement of weak acid dissociable cyanide.

2. Mercury Mass Limit and Mass Trigger

Until TMDL and WLA efforts for mercury provide enough information to establish a different WQBEL, the Discharger shall demonstrate that the current mercury mass loading to the receiving water does not increase by complying with the following:

- a. Mass limit: The 12-month moving average annual load for mercury shall not exceed 0.73 grams per month (g/mo). Compliance shall be calculated using 12-month moving average loadings to the receiving water for the entire year (during both discharge and reclamation months).
- b. Mass trigger: If the 12-month moving average monthly mass loading for mercury exceeds 0.33 g/mo, the actions specified in Provision VII.C.3.b. shall be initiated. Failure to initiate and complete the actions will be considered a permit condition violation.
- c. Compliance determination method: Compliance for each month will be determined based on the 12-month moving averages over the previous 12 months of monitoring calculated using the method described below:

Monthly mass emission loading, in g/mo = [Flow 1 × Hg Concentration 1 + Flow 2 × Hg Concentration 2] × 115.0

12-month moving average Hg mass loading = Running average of last 12 monthly mercury mass loadings in g/mo

Where:

Flow 1 – river discharge flow from Outfall 001, Monthly Average = total discharge flow from 001 divided by number of days in a calendar month, in MGD

Hg Concentration 1 – mercury concentration for Outfall 001, Monthly Average, in µg/L

Flow 2 – river discharge flow from Outfall 002, Monthly Average = total discharge flow from 002 divided by number of days in a calendar month, in MGD

Hg Concentration 2 – mercury concentration for Outfall 002, Monthly Average, in $\mu\text{g/L}$

115.0 - conversion factor.

For mercury mass loading calculation, if there is no receiving water body discharge during a calendar month, the flow is set to zero for that month.

If there is no mercury effluent data, i.e., during non-discharge season, the concentration for that calendar month is left blank in the spreadsheet. If more than one measurement is obtained in a calendar month, the average of these concentrations is used as the monthly value for that month. If the results are less than the method detection limit used, the concentrations are assumed to be equal to the method detection limit.

- d. The mercury TMDL and WLAs will supersede the final effluent limits (in Table 4 above) and interim mass emission limitation upon their adoption. The Clean Water Act's anti-backsliding rule, Section 402(o), indicates that this Order may be modified to include a less stringent requirement following adoption of the TMDL and WLA, if the requirements for an exception to the rule are met.

V. RECEIVING WATER LIMITATIONS

A. Surface Water Limitations

Receiving water limitations are based on water quality objectives contained in the Basin Plan and are a required part of this Order. The discharge shall not cause the following in the Napa River:

1. The discharge shall not cause the following conditions to exist in waters of the State at any place:
 - a. Floating, suspended, or deposited macroscopic particulate matter or foams;
 - b. Bottom deposits or aquatic growths to the extent that such deposits or growths cause nuisance or adversely affect beneficial uses;
 - c. Alteration of temperature, turbidity, or apparent color which cause nuisance or adversely affect beneficial uses;
 - d. Visible, floating, suspended, or deposited oil and other products of petroleum origin; and
 - e. Toxic or other deleterious substances to be present in concentrations or quantities which will cause deleterious effects on wildlife, waterfowl, or other aquatic biota, or which render any of these unfit for human consumption, either at levels created in the receiving waters or as a result of biological concentration.

2. The discharge of waste shall not cause the following limits to be exceeded in waters of the State at any place within one foot of the water surface:

- a. Dissolved Oxygen: 7.0 mg/L, minimum

The median dissolved oxygen concentration for any three consecutive months shall not be less than 80% of the dissolved oxygen content at saturation. When natural factors cause concentrations less than that specified above, the discharge shall not cause further reduction in ambient dissolved oxygen concentrations.

- b. Dissolved Sulfide: 0.1 mg/L, maximum

- c. pH: Variation from normal ambient pH by more than 0.5 pH units.

- d. Un-ionized Ammonia: 0.025 mg/L as N, annual median; and
0.16 mg/L as N, maximum.

- e. Nutrients: Waters shall not contain biostimulatory substances in concentrations that promote aquatic growths to the extent that such growths cause nuisance or adversely affect beneficial uses.

3. The discharge shall not cause a violation of any particular water quality standard for receiving waters adopted by the Regional Water Board or the State Water Board as required by the Clean Water Act and regulations adopted thereunder. If more stringent applicable water quality standards are promulgated or approved pursuant to Section 303 of the CWA, or amendments thereto, the Regional Water Board may reopen and modify this Order in accordance with such more stringent standards.

B. Groundwater Limitations – N/A

VI. POND EFFLUENT LIMITATIONS

- A. Wastewater within one foot of the surface of all wastewater ponds shall meet the following limits, in any grab sample:
1. Dissolved Oxygen: 2.0 mg/L, minimum.
 2. Dissolved Sulfide: 0.1 mg/L, maximum.
- B. 1. A minimum freeboard of at least one (1) foot shall be maintained in existing treatment plant Pond 1.
2. A minimum freeboard of at least two (2) feet shall be maintained in existing treatment plant Pond 2.
- C. All ponds shall be protected against erosion, flooding and washout from floods having a predicted frequency of once in 100 years.
- D. The waste shall not cause a significant degradation of any ground water so as to impair beneficial uses.

VII. PROVISIONS

A. Standard Provisions

1. **Federal Standard Provisions.** The Discharger shall comply with all Standard Provisions included in **Attachment D**.
2. **Regional Water Board Standard Provisions.** The Discharger shall comply with all applicable items of the attached *Standard Provisions and Reporting Requirements for NPDES Surface Water Discharge Permits, August 1993* (the Standard Provisions, **Attachment G**), and any amendment thereto. Where provisions or reporting requirements specified in this Order are different from equivalent or related provisions or reporting requirements given in the Standard Provisions (**Attachment G**), the specifications of this Order shall apply. Duplicative requirements in the federal Standard Provisions in VI.A.1.2, above (**Attachment D**) and the regional Standard Provisions (**Attachment G**) are not separate requirements. A violation of a duplicative requirement does not constitute two separate violations.

B. Monitoring and Reporting Program Requirements

The Discharger shall comply with the Monitoring and Reporting Program, and future revisions thereto, in **Attachment E**. The Discharger shall also comply with the requirements contained in *Self-Monitoring Program, Part A, August 1993* (**Attachment G**).

C. Special Provisions

1. Reopener Provisions

The Regional Water Board may modify or reopen this Order prior to its expiration date in any of the following circumstances as allowed by law:

- a. If present or future investigations demonstrate that the discharge(s) governed by this Order will or have a reasonable potential to cause or contribute to, or will cease to, have adverse impacts on water quality and/or beneficial uses of the receiving waters.
- b. If new or revised WQOs, or TMDLs come into effect for the San Francisco Bay estuary and contiguous water bodies (whether statewide, regional, or site-specific). In such cases, effluent limitations in this Order will be modified as necessary to reflect updated WQOs and waste load allocations in TMDLs. Adoption of effluent limitations contained in this Order is not intended to restrict in any way future modifications based on legally adopted WQOs, TMDLs, or as otherwise permitted under Federal regulations governing NPDES permit modifications.
- c. If translator or other water quality studies provide a basis for determining that a permit condition(s) should be modified.
- d. If administrative or judicial decision on a separate NPDES permit or WDR that addresses requirements similar to this discharge.
- e. Or as otherwise authorized by law.

The Dischargers may request permit modification based on the above. The Dischargers shall include in any such request an antidegradation and antibacksliding analysis.

2. Special Studies, Technical Reports and Additional Monitoring Requirements

a. Effluent Characterization for Selected Constituents

The Discharger shall continue to monitor and evaluate the discharge from Outfall 001 and 002 (measured at M-001 and M-002) for the constituents listed in Enclosure A of the Regional Water Board's August 6, 2001 Letter, according to the sampling frequency specified in the attached MRP (**Attachment E**). Compliance with this requirement shall be achieved in accordance with the specifications stated in the Regional Water Board's August 6, 2001 Letter under Effluent Monitoring for Minor Discharger.

The Discharger shall evaluate on an annual basis if concentrations of any constituent increase over past performance. The Discharger shall investigate the cause of the increase. The investigation may include, but need not be limited to, an increase in the effluent monitoring frequency, monitoring of internal process streams, and monitoring of

influent sources. This may be satisfied through identification of these constituents as “Pollutants of Concern” in the Discharger’s Pollutant Minimization Program described in **Provision VII.C.3.a**, below. A summary of the annual evaluation of data and source investigation activities shall also be reported in the annual self-monitoring report.

A final report that presents all the data shall be submitted to the Regional Water Board no later than 180 days prior to the Order expiration date. This final report shall be submitted with the application for permit reissuance.

b. Ambient Background Receiving Water Study

The Discharger shall collect or participate in collecting background ambient receiving water monitoring data for priority pollutants that is required to perform reasonable potential analyses and to calculate effluent limitations. The data on the conventional water quality parameters (pH, salinity, and hardness) shall also be sufficient to characterize these parameters in the receiving water at a point after the discharge has mixed with the receiving waters. This provision may be met by monitoring through the Collaborative Napa River Receiving Water Study or a similar ambient monitoring program for the Napa River. This permit may be reopened, as appropriate, to incorporate effluent limitations or other requirements based on Regional Water Board’s review of these data.

The Discharger shall submit a final report that presents all the data to the Regional Water Board 180 days prior to Order expiration. This final report shall be submitted with the application for permit reissuance.

c. Diffuser Feasibility Study, Design, and Installation

If the Discharger agrees to complete a dilution credit determination study under Provision VII.C.2.d, the following requirements shall not apply.

If the Discharger decides to install diffuser(s) at Outfall 001 or at both Outfalls 001 and 002, it shall comply with the following tasks and deadlines (if a diffuser is only considered for Outfall 001, the Discharger shall perform the study specified under VII.C.2.d. below for discharges from Outfall 002):

Tasks	Deadline
1) The Discharger shall evaluate the feasibility of installing a deep-water diffuser. Submit the feasibility analysis report to the Regional Water Board.	April 1, 2007.
2) If a diffuser is feasible, and the Discharger decides to install a diffuser, the Discharger shall complete the preliminary design of a diffuser.	November 1, 2007.

Tasks	Deadline
3) The Discharger shall initiate and facilitate the environmental review process, which is expected to include permits from at least the State Lands Commission, California Department of Fish and Game, and the Regional Water Board.	February 1, 2008, to initiate the environmental review process.
4) The Discharger shall complete construction of the diffuser after approval of necessary environmental and other permits. Construction is expected to take 8 to 9 months, and should be completed in the dry season when river flows are low.	Starting in the month of July, following approval of necessary environmental and other permits, and ending no later than the following November 1.
5) The Discharger shall provide progress reports on the status of the diffuser installation by February 1 of each year, starting in 2008, until the project is completed.	Annually on February 1, 2008, maybe part of annual self-monitoring reports.

d. Mixing Zone and Dilution Credit Determination Study and Alternate Final WQBELs

If the Discharger agrees to install a diffuser, the following requirements shall not apply.

(1) If a diffuser is not feasible, or if the Discharger does not plan to install a diffuser at either Outfall 001 or 002, it shall perform a study to demonstrate an appropriate dilution credit the discharge receives. The Discharger shall comply with the following tasks and deadlines:

Tasks	Compliance Date
i) <i>Study Plan.</i> The Discharger shall prepare a dilution study plan, acceptable to the Executive Officer. The plan shall describe the methodology for evaluating an appropriate dilution credit for the discharge.	April 1, 2007.
ii) <i>Study Commencement.</i> The Discharger shall initiate the study upon Executive Officer's approval or after 45 days if Executive Officer has not commented on the study plan.	Within 30 days of Executive Officer approval.
iii) <i>Report.</i> The Discharger shall submit a report, acceptable to the Executive Officer, summarizing the study results. The report shall propose a dilution credit for WQBELs' calculation.	July 1, 2009.

Tasks	Compliance Date
iv) <i>Feasibility Analysis.</i> The Discharger shall also submit a feasibility analysis, acceptable to the Executive Officer, demonstrating feasibility to comply with the final WQBELs calculated using the proposed dilution credit.	July 1, 2009.

(2) Based on the Discharger’s completed dilution study, the Executive Officer will approve a dilution credit and associated dilution ratio for Outfalls 001 and 002. WQBELs based on the approved dilution credit will be calculated at the time of next permit reissuance.

e. Secondary Discharge Performance and Effluent Limitation Study

(1) *Performance Monitoring and Reporting.*

- i) The Discharger shall continue to operate and maintain the treatment plant in the manner as is currently done, which has generally resulted in better than secondary quality effluent at Outfall 002 for BOD and TSS.
- ii) The Discharger shall submit an analysis with its monthly self-monitoring report, within 30 days of last discharge episode, if Outfall 002 effluent quality drops below tertiary levels for BOD and TSS (as defined in Table 2) for more than 2 consecutive Outfall 002 river discharge episodes (one episode is one consecutive discharge event, which may last variable days). The Discharger shall conduct a review to determine if such deviations were reasonably within its operational control. If such deviations were reasonably within the Discharger’s operational control, the Discharger will take reasonable operational actions to attempt to prevent future deviations based on the same factors. The Discharger will describe these operational actions in its self-monitoring report as an information item.

(2) *Conditions for Performing a Special Study.*

- i) *Study Plan.* If more than 50% of the Outfall 002 discharge episodes in a single river discharge season (November 1st to June 15th) do not meet the tertiary levels for BOD and TSS as defined in Table 2, the Discharger shall prepare a study plan, acceptable to the Executive Officer. The plan shall describe the methodology for evaluating whether the existing technology-based effluent limits will be protective of the beneficial uses of the receiving water. The study shall address, but not be limited to, the following aspects: (1) Is the receiving water in compliance with the Basin Plan receiving water dissolved oxygen limitations for cold fresh water, specifically, to support steelhead spawning? (2) What are the recent levels of BOD and TSS in the discharge? (3) If the effluent were to be discharged at the secondary technology-based effluent limits (as defined in Table 3) (worst case

scenario) and at the recently measured levels of BOD and TSS, will there be impacts to the receiving water, such as alteration of dissolved oxygen?

- ii) *Study Commencement.* The Discharger shall initiate the study within 30 days of the Executive Officer's approval or after 45 days if the Executive Officer has not commented on the study plan.
- iii) *Report.* Within 6 months of study commencement, the Discharger shall submit a report, acceptable to the Executive Officer, summarizing the study results.

If the report shows conclusively that a measurable negative impact on cold fresh water beneficial uses of the receiving waters could result if discharge BOD and TSS concentrations are at the secondary treatment limits, then the Regional Water Board staff may consider, during development of the next permit, setting more stringent effluent limits for BOD and TSS for Outfall 002.

f. Mass Offset (Optional)

If the Discharger can demonstrate that further net reductions of the total mass loadings of 303(d)-listed pollutants to the receiving water cannot be achieved through economically feasible measures such as aggressive source control, wastewater reuse, and treatment plant optimization, but only through a mass offset program, the Discharger may submit to the Regional Water Board for approval a mass offset plan to reduce 303(d)-listed pollutants to the same watershed or drainage basin. The Regional Water Board may modify this Order to allow an approved mass offset program.

g. Status Report on 303(d)-Listed Pollutants, Site-Specific Objectives (SSOs) and TMDL

By January 31 of each year, the Discharger shall submit an update to the Regional Water Board to document its participation efforts toward development of the TMDL(s) or SSO(s). The Discharger can submit updates through the regional Bay Area Clean Water Agencies (BACWA) studies for these pollutants. These status reports must address, but not be limited to, the Discharger's efforts in support of the TMDL mercury.

3. Best Management Practices and Pollution Prevention

a. Pollutant Minimization Program

- 1) The Discharger shall conduct, in a manner acceptable to the Executive Officer, a Pollutant Minimization Program to reduce loadings of copper, mercury, cyanide, chlorodibromomethane, and dichlorobromomethane to the plant and therefore to the receiving waters.

- 2) The Discharger shall submit an annual report, acceptable to the Executive Officer, no later than February 28th of each year. Annual reports shall cover January through December of the preceding year. Annual reports shall include at least the following information:
 - i) *A Brief Description of the Plant, Plant Processes, and Service Area.*
 - ii) *A Discussion of the Current Pollutants of Concern.* Periodically, the Discharger shall analyze its own situation to determine which pollutants are currently a problem and/or which pollutants may be potential future problems. This discussion shall include the reasons why the pollutants were chosen. In particular, the Discharger shall address those pollutants for which there is a reasonable potential to cause or contribute to exceedance of WQOs/WQC, specifically, copper, mercury, cyanide, chlorodibromomethane, and dichlorobromomethane.
 - iii) *Identification of Sources for the Pollutants of Concern.* This discussion shall include how the Discharger intends to estimate and identify sources of the pollutants. The Discharger shall also identify sources or potential sources not directly within the ability or authority of the Discharger to control, such as pollutants in the potable water supply and air deposition.
 - iv) *Identification of Tasks to Reduce the Sources of the Pollutants of Concern.* This discussion shall identify and prioritize tasks to address the Discharger's pollutants of concern. The Discharger may implement tasks itself or participate in group, regional, or national tasks that will address its pollutants of concern. The Discharger is strongly encouraged to participate in group, regional, or national tasks that will address its pollutants of concern whenever it is efficient and appropriate to do so. A time line shall be included for the implementation of each task.
 - v) *Outreach to Employees.* The Discharger shall inform employees about the pollutants of concern, potential sources, and how they might be able to help reduce the discharge of these pollutants of concern into the plant. The Discharger may provide a forum for employees to provide input to the program.
 - vi) *Continuation of Public Outreach Program.* The Discharger shall prepare a public outreach program to communicate pollution prevention to its service area. Outreach may include participation in existing community events such as county fairs, initiating new community events such as displays and contests during Pollution Prevention Week, conducting school outreach programs, conducting plant tours, and providing public information in newspaper articles or advertisements, radio or television stories or spots, newsletters, utility bill inserts, and web site. Information shall be specific to the target audiences. The Discharger shall coordinate with other agencies as appropriate.

- vii) *Discussion of Criteria Used to Measure the Program's and Tasks' Effectiveness.* The Discharger shall establish criteria to evaluate the effectiveness of its Pollution Prevention Program. This shall also include a discussion of the specific criteria used to measure the effectiveness of each of the tasks in item (2)(iv), (2)(v), and (2)(vi).
- viii) *Documentation of Efforts and Progress.* This discussion shall detail all the Discharger's activities in the Pollution Prevention Program during the reporting year.
- ix) *Evaluation of Program's and Tasks' Effectiveness.* The Discharger shall use the criteria established in (2)(vii) to evaluate the Program's and tasks' effectiveness.
- x) *Identification of Specific Tasks and Time Schedules for Future Efforts.* Based on the evaluation, the Discharger shall detail how it intends to continue or change its tasks to more effectively reduce the amount of pollutants to the plant, and subsequently in its effluent.

3) Pollutant Minimization Program for Pollutants with Effluent Limitations

The Discharger shall develop and conduct a Pollutant Minimization Program (PMP) as further described below when there is evidence (e.g., sample results reported as DNQ when the effluent limitation is less than the MDL, sample results from analytical methods more sensitive than those methods required by this Order, presence of whole effluent toxicity, health advisories for fish consumption, results of benthic or aquatic organism tissue sampling) that a priority pollutant is present in the effluent above an effluent limitation and either:

- i. A sample result is reported as DNQ and the effluent limitation is less than the RL;
or
- ii. A sample result is reported as ND and the effluent limitation is less than the MDL, using definitions described in the SIP.

4) If triggered by the reasons in (3) above, the Discharger's PMP shall include, but not be limited to, the following actions and submittals acceptable to the Regional Water Board:

- i. An annual review and semi-annual monitoring of potential sources of the reportable priority pollutant(s), which may include fish tissue monitoring and other bio-uptake sampling, or alternative measures approved by the Executive Officer when it is demonstrated that source monitoring is unlikely to produce useful analytical data;

- ii. Quarterly monitoring for the reportable priority pollutant(s) in the influent to the wastewater treatment system, or alternative measures approved by the Executive Officer, when it is demonstrated that influent monitoring is unlikely to produce useful analytical data;
- iii. Submittal of a control strategy designed to proceed toward the goal of maintaining concentrations of the reportable priority pollutant(s) in the effluent at or below the effluent limitation;
- iv. Implementation of appropriate cost-effective control measures for the reportable priority pollutant(s), consistent with the control strategy; and
- v. The annual report required by 3.b. above, shall specifically address the following items:
 - (a) All PMP monitoring results for the previous year;
 - (b) A list of potential sources of the reportable priority pollutant(s);
 - (c) A summary of all actions undertaken pursuant to the control strategy; and
 - (d) A description of actions to be taken in the following year.

b. Mercury Mass Loading Reduction

If mass loading for mercury exceeds the trigger level specified in IV.B.2.b of this Order, then the following actions shall be initiated and subsequent reports shall include but not be limited to the following:

- 1) *Notification*: Any exceedance of the trigger specified in Effluent Limitation IV.B.2.b shall be reported to the Regional Water Board in accordance with Section V.E in **Attachment G** (The Standard Provisions).
- 2) *Identification of the problem*: Resample to verify the increase in loading. If resampling confirms that the mass loading trigger has been exceeded, determine whether the exceedance is flow or concentration-related. If the exceedance is flow related, identify whether it relates to changes in reclamation, increases in the number of sewer connections, increases in infiltration and inflow (I/I), wet season conditions, or unknown sources. If the exceedance is concentration-related, identify whether it is related to industrial, commercial, residential, or unknown sources.
- 3) *Investigation of corrective action*: Investigate the feasibility of the following actions:
 - (a) Improving public education and outreach,
 - (b) Reducing inflow and infiltration (I/I), and

(c) Increasing reclamation.

Within 60 days after confirmed exceedance, develop a plan and include time schedule as short as practicable, acceptable to the Executive Officer, to implement all reasonable actions to maintain mercury mass loadings at or below the mass loading trigger contained in Effluent Limitation IV.B.2.b.

- 4) *Investigation of aggressive prevention/reduction measures:* In the event the exceedance is related to growth and the plan required under (3) above is not expected to keep mercury mass loadings below the mass loading trigger, the Discharger shall submit a plan, acceptable to the Executive Officer. The plan should include an initiative to work with the local planning department to investigate the feasibility and potential benefits of requiring water conservation, reclamation, and dual plumbing for new development. This plan should be implemented as soon as practicable.

4. Compliance Schedules - Dichlorobromomethane and Chlorodibromomethane

This Order grants interim effluent limits and compliance schedule for several pollutants, including the two pollutants listed above. The Discharger shall implement the tasks proposed in the Discharger’s Infeasibility Analysis dated June 5, 2006; in addition, the Discharger shall implement the tasks as follow:

Task	Deadline
1) The Discharger proposed in the Infeasibility Analysis to sample the influent for two years to identify the source of dichlorobromomethane and chlorodibromomethane. The Discharger shall submit a progress report and a final report summarizing the data and findings.	Progress report due July 1, 2007 Final report due July 1, 2008.
2a) The Discharger shall also look at other recently performed studies on the formation of these two disinfection byproducts in POTWs, such as by City of Sunnyvale and City of Palo Alto, and decide whether the study results can be applied to its Facility. If other study results can be applied to the Discharger’s Facility, the Discharger shall submit a work plan including proposed measures to reduce these two pollutants in the effluent.	August 1, 2007.
2b) Upon approval by the Executive Officer or within 45 days if E.O. has not commented on the study plan, the Discharger shall implement the work plan within 60 days (or upon the start of discharge season). The Discharger shall implement the proposed measures,	Annual Reports with the first report due on February 1, 2007, maybe part of annual self-monitoring reports.

Task	Deadline
<p>and submit annual progress reports. Annual reports shall be submitted documenting the progress of the studies by February 1 of each year or by the date specified in the approved proposal. The Discharger shall submit to the Regional Water Board a final report detailing all activities, any monitoring data, and additional recommended actions to comply with the final effluent limitations by the end of the compliance schedule.</p>	
<p>3a) If the Discharger finds that it cannot apply other study results to its Facility, and exceedances of WQBELs for dichlorobromomethane and chlorodibromomethane still are occurring and no influent source is identified, the Discharger shall submit a work plan that will include tasks intended to define the correlation between chlorine dosages and formation of chlorodibromomethane and dichlorobromomethane, such as conducting monitoring throughout the treatment process and analyzing chlorine dosage histories.</p>	<p>September 1, 2008.</p>
<p>3b) Upon approval by the Executive Officer or within 45 days if E.O. has not commented on the study plan, the Discharger shall implement the work plan within 60 days (or upon the start of discharge season). Annual reports shall be submitted documenting the progress of the studies by February 1 of each year or by the date specified in the approved proposal. The Discharger will submit to the Regional Water Board a final report detailing all monitoring activities, potential cost-effective control measures, and recommended actions to comply with the final effluent limitations by the end of the compliance schedule.</p>	<p>Annual Reports with the first report due on the first February 1 after the study is initiated, maybe part of annual self-monitoring reports.</p>
<p>4) Conduct evaluation of compliance attainability with appropriate final limitations, and submit a report describing the results.</p>	<p>September 1, 2009.</p>

5. Construction, Operation and Maintenance Specifications

a. Wastewater Facilities, Review and Evaluation, and Status Reports

- 1) The Discharger shall operate and maintain its wastewater collection, treatment, and disposal facilities in a manner to ensure that all facilities are adequately staffed, supervised, financed, operated, maintained, repaired, and upgraded as necessary, in order to provide adequate and reliable transport, treatment, and disposal of all wastewater from both existing and planned future wastewater sources under the Discharger's service responsibilities.
- 2) The Discharger shall regularly review and evaluate its wastewater facilities and operation practices in accordance with section a.1 above. Reviews and evaluations shall be conducted as an ongoing component of the Discharger's administration of its wastewater facilities.
- 3) The Discharger shall provide the Executive Officer, upon request, a report describing the current status of its wastewater facilities and operation practices, including any recommended or planned actions and an estimated time schedule for these actions. The Discharger shall also include, in each annual self-monitoring report, a description or summary of review and evaluation procedures, and applicable wastewater facility programs or capital improvement projects.

b. Operations and Maintenance Manual (O&M), Review and Status Reports

- 1) The Discharger shall maintain an O&M Manual as described in the findings of this Order for the Discharger's wastewater facilities. The O&M Manual shall be maintained in usable condition and be available for reference and use by all applicable personnel.
- 2) The Discharger shall regularly review, revise, or update, as necessary, the O&M Manual(s) so that the document(s) may remain useful and relevant to current equipment and operation practices. Reviews shall be conducted annually, and revisions or updates shall be completed as necessary. For any significant changes in treatment facility equipment or operation practices, applicable revisions shall be completed within 90 days of completion of such changes.
- 3) The Discharger shall provide the Executive Officer, upon request, a report describing the current status of its O&M manual, including any recommended or planned actions and an estimated time schedule for these actions. The Discharger shall also include, in each annual self-monitoring report, a description or summary of review and evaluation procedures and applicable changes to its operations and maintenance manual.

c. Contingency Plan, Review and Status Reports

- 1) The Discharger shall maintain a Contingency Plan as required by Regional Water Board Resolution 74-10 (**Attachment G**) and as prudent in accordance with current municipal facility emergency planning. The discharge of pollutants in violation of this Order where the Discharger has failed to develop and/or adequately implement a Contingency Plan will be the basis for considering such discharge a willful and negligent violation of this Order pursuant to Section 13387 of the California Water Code.
- 2) The Discharger shall regularly review and update, as necessary, the Contingency Plan so that the plan may remain useful and relevant to current equipment and operation practices. Reviews shall be conducted annually, and updates shall be completed as necessary.
- 3) The Discharger shall provide the Executive Officer, upon request, a report describing the current status of its Contingency Plan review and update. The Discharger shall also include, in each annual self-monitoring report, a description or summary of review and evaluation procedures and applicable changes to its Contingency Plan.

6. Special Provisions for POTWs

a. Sludge Management Practices Requirements

- 1) All sludge generated by the Discharger must be disposed of in a municipal solid waste landfill, reused by land application, or disposed of in a sludge-only landfill in accordance with 40 CFR §503. If the Discharger desires to dispose of sludge by a different method, a request for permit modification must be submitted to USEPA 180 days before start-up of the alternative disposal practice. All the requirements in 40 CFR §503 are enforceable by USEPA whether or not they are stated in an NPDES permit or other permit issued to the Discharger. The Regional Water Board should be copied on relevant correspondence and reports forwarded to USEPA regarding sludge management practices.
- 2) Sludge treatment, storage and disposal or reuse shall not create a nuisance, such as objectionable odors or flies, or result in groundwater contamination.
- 3) The Discharger shall take all reasonable steps to prevent or minimize any sludge use or disposal which has a likelihood of adversely affecting human health or the environment.

- 4) The discharge of biosolids shall not cause waste material to be in a position where it is or can be carried from the sludge treatment and storage site and deposited in waters of the State.
- 5) The sludge treatment and storage site shall have facilities adequate to divert surface runoff from adjacent areas, to protect boundaries of the site from erosion, and to prevent any conditions that would cause drainage from the materials in the temporary storage site. Adequate protection is defined as protection from at least a 100-year storm and protection from the highest possible tidal stage that may occur.
- 6) For sludge that is applied to the land, placed on a surface disposal site, or fired in a biosolids incinerator as defined in 40 CFR §503, the Discharger shall submit an annual report to USEPA and the Regional Water Board containing monitoring results and pathogen and vector attraction reduction requirements as specified by 40 CFR §503, postmarked February 15 of each year, for the period covering the previous calendar year.
- 7) Sludge that is disposed of in a municipal solid waste landfill must meet the requirements of 40 CFR §258. In the annual self-monitoring report, the Discharger shall include the amount of sludge disposed of and the landfill(s) to which it was sent.
- 8) Permanent on-site sludge storage or disposal activities are not authorized by this permit. A report of Waste Discharge shall be filed and the site brought into compliance with all applicable regulations prior to commencement of any such activity by the Discharger.
- 9) Sludge Monitoring and Reporting Provisions of this Regional Water Board's Standard Provisions (**Attachment G**), apply to sludge handling, disposal and reporting practices.
- 10) The Regional Water Board may amend this permit prior to expiration if changes occur in applicable state and federal sludge regulations.

b. Sanitary Sewer Overflows and Sewer System Management Plan

The Discharger's collection system is part of the facility that is subject to this Order. As such, the Discharger must properly operate and maintain its collection system (**Attachment D**, Standard Provisions – Permit Compliance, subsection I.D). The Discharger must report any noncompliance (**Attachment D**, Standard Provisions – Reporting, subsections V.E.1 and V.E.2) and mitigate any discharge from the Discharger's collection system in violation of this Order (**Attachment D**, Standard Provisions – Permit Compliance, subsection I.C). The General Waste Discharge Requirements for Collection System Agencies (Order No. 2006-0003 DWQ) has requirements for operation and maintenance of collection systems and for reporting and mitigating sanitary sewer overflows. While the Discharger must comply with both the

General Waste Discharge Requirements for Collection System Agencies (General Collection System WDR) and this Order, the General Collection System WDR more clearly and specifically stipulates requirements for operation and maintenance and for reporting and mitigating sanitary sewer overflows. Implementation of the General Collection System WDR requirements for proper operation and maintenance and mitigation of spills will satisfy the corresponding federal NPDES requirements specified in this Order. Following reporting requirements in the General Collection System WDR will satisfy NPDES reporting requirements for sewage spills. Furthermore, the Discharger shall comply with the schedule for development of sewer system management plans (SSMPs) as indicated in the letter issued by the Regional Water Board on July 7, 2005, pursuant to Water Code Section 13267. Until the statewide on-line reporting system becomes operational, the Discharger shall report sanitary sewer overflows electronically according to the Regional Water Board's SSO reporting program.

7. Other Special Provisions

Emergency Discharge Request Procedure

To obtain approval for an emergency discharge during the June 16 through October 31 period, the Discharger shall submit a written request to the Executive Officer at least 3 business days in advance of the proposed discharge. The discharge request must include reasons for the discharge, e.g., planned disposal to land is infeasible, storage ponds are full, or storage ponds are projected to be full before the discharge season starts due to wet season conditions. A water balance calculation and pond storage conditions shall be included to support the request. A water balance calculation shall be based on the actual pond depths and the targeted pond depths from the beginning of the reclamation season to the current month, as well as precipitation, evaporation, reclamation, and/or long-range weather forecast, etc. Other supporting information shall include, but not be limited to, projected duration of discharge, discharge rate, Napa River flow rates, dilution ratio the discharge will get, and plans/dates for correcting problems. The Executive Officer will authorize a specific time frame and additional monitoring and reporting requirements for the discharge. Regional Water Board staff will respond by phone, via email, or in writing to the Discharger before the requested discharge can occur.

VIII. COMPLIANCE DETERMINATION

Compliance with the effluent limitations contained in Section IV of this Order will be determined as specified below:

A. General

Compliance with effluent limitations for priority pollutants shall be determined using sample reporting protocols defined in the MRP and **Attachment A** of this Order. For purposes of reporting and administrative enforcement by the Regional and State Water Boards, the Discharger shall be deemed out of compliance with effluent limitations if the concentration of the priority pollutant in the monitoring sample is greater than the effluent limitation and greater than or equal to the reporting level (RL).

B. Multiple Sample Data

When determining compliance with an AMEL, AWEL, or MDEL for priority pollutants and more than one sample result is available, the Discharger shall compute the arithmetic mean unless the data set contains one or more reported determinations of “Detected, but Not Quantified” (DNQ) or “Not Detected” (ND). In those cases, the Discharger shall compute the median in place of the arithmetic mean in accordance with the following procedure:

1. The data set shall be ranked from low to high, ranking the reported ND determinations lowest, DNQ determinations next, followed by quantified values (if any). The order of the individual ND or DNQ determinations is unimportant.
2. The median value of the data set shall be determined. If the data set has an odd number of data points, then the median is the middle value. If the data set has an even number of data points, then the median is the average of the two values around the middle unless one or both of the points are ND or DNQ, in which case the median value shall be the lower of the two data points where DNQ is lower than a value and ND is lower than DNQ.

C. Average Monthly Effluent Limitation (AMEL)

If the average (or when applicable, the median determined by subsection B above for multiple sample data) of daily discharges over a calendar month exceeds the AMEL for a given parameter, this will represent a single violation, though the Discharger will be considered out of compliance for each day of that month for that parameter (e.g., resulting in 31 days of non-compliance in a 31-day month). If only a single sample is taken during the calendar month and the analytical result for that sample exceeds the AMEL, the Discharger will be considered out of compliance for that calendar month. The Discharger will only be considered out of compliance for days when the discharge occurs. For any one calendar month during which no sample (daily discharge) is taken, no compliance determination can be made for that calendar month.

D. Average Weekly Effluent Limitation (AWEL)

If the average (or when applicable, the median determined by subsection B above for multiple sample data) of daily discharges over a calendar week exceeds the AWEL for a given parameter, this will represent a single violation, though the Discharger will be considered out of compliance

for each day of that week for that parameter, resulting in 7 days of non-compliance. If only a single sample is taken during the calendar week and the analytical result for that sample exceeds the AWEL, the Discharger will be considered out of compliance for that calendar week. The Discharger will only be considered out of compliance for days when the discharge occurs. For any one calendar week during which no sample (daily discharge) is taken, no compliance determination can be made for that calendar week.

E. Maximum Daily Effluent Limitation (MDEL)

If a daily discharge (or when applicable, the median determined by subsection B above for multiple sample data of a daily discharge) exceeds the MDEL for a given parameter, the Discharger will be considered out of compliance for that parameter for that 1 day only within the reporting period. For any 1 day during which no sample is taken, no compliance determination can be made for that day.

F. Instantaneous Minimum Effluent Limitation

If the analytical result of a single grab sample is lower than the instantaneous minimum effluent limitation for a parameter, the Discharger will be considered out of compliance for that parameter for that single sample. Non-compliance for each sample will be considered separately (e.g., the results of two grab samples taken within a calendar day that both are lower than the instantaneous minimum effluent limitation would result in two instances of non-compliance with the instantaneous minimum effluent limitation).

G. Instantaneous Maximum Effluent Limitation

If the analytical result of a single grab sample is higher than the instantaneous maximum effluent limitation for a parameter, the Discharger will be considered out of compliance for that parameter for that single sample. Non-compliance for each sample will be considered separately (e.g., the results of two grab samples taken within a calendar day that both exceed the instantaneous maximum effluent limitation would result in two instances of non-compliance with the instantaneous maximum effluent limitation).

ATTACHMENT A – DEFINITIONS

Average Monthly Effluent Limitation (AMEL): the highest allowable average of daily discharges over a calendar month, calculated as the sum of all daily discharges measured during a calendar month divided by the number of daily discharges measured during that month.

Average Weekly Effluent Limitation (AWEL): the highest allowable average of daily discharges over a calendar week (Sunday through Saturday), calculated as the sum of all daily discharges measured during a calendar week divided by the number of daily discharges measured during that week.

Daily Discharge: Daily Discharge is defined as either: (1) the total mass of the constituent discharged over the calendar day (12:00 am through 11:59 pm) or any 24-hour period that reasonably represents a calendar day for purposes of sampling (as specified in the permit), for a constituent with limitations expressed in units of mass or; (2) the unweighted arithmetic mean measurement of the constituent over the day for a constituent with limitations expressed in other units of measurement (e.g., concentration).

The daily discharge may be determined by the analytical results of a composite sample taken over the course of one day (a calendar day or other 24-hour period defined as a day) or by the arithmetic mean of analytical results from one or more grab samples taken over the course of the day.

For composite sampling, if 1 day is defined as a 24-hour period other than a calendar day, the analytical result for the 24-hour period will be considered as the result for the calendar day in which the 24-hour period ends.

Instantaneous Maximum Effluent Limitation: the highest allowable value for any single grab sample or aliquot (i.e., each grab sample or aliquot is independently compared to the instantaneous maximum limitation).

Instantaneous Minimum Effluent Limitation: the lowest allowable value for any single grab sample or aliquot (i.e., each grab sample or aliquot is independently compared to the instantaneous minimum limitation).

Maximum Daily Effluent Limitation (MDEL): the highest allowable daily discharge of a pollutant.

Reporting Level (RL) is the ML (and its associated analytical method) chosen by the Discharger for reporting and compliance determination from the MLs included in this Order. The MLs included in this Order correspond to approved analytical methods for reporting a sample result that are selected by the Regional Water Board either from Appendix 4 of the SIP in accordance with section 2.4.2 of the SIP or established in accordance with section 2.4.3 of the SIP. The ML is based on the proper application of method-based analytical procedures for sample preparation and the absence of any matrix interferences. Other factors may be applied to the ML depending on the specific sample preparation steps employed. For example, the treatment typically applied in cases where there are matrix-effects is to dilute the sample or sample aliquot by a factor of ten. In such cases, this additional factor must be applied to the ML in the computation of the RL.

ATTACHMENT B (1) – FACILITY LOCATION MAP

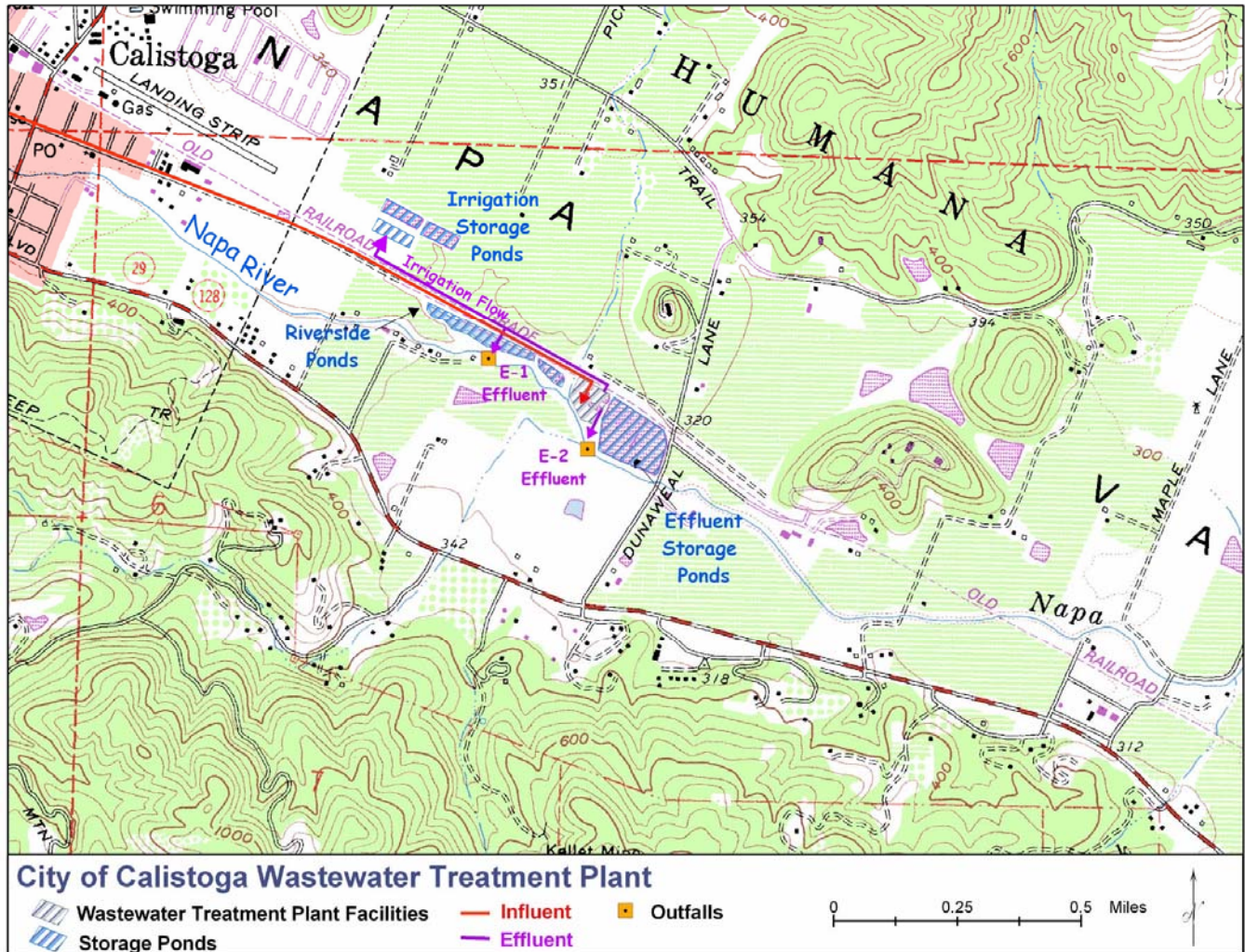

ATTACHMENT B (2) – RECEIVING WATER MONITORING STATION MAP



ATTACHMENT C – FLOW SCHEMATIC

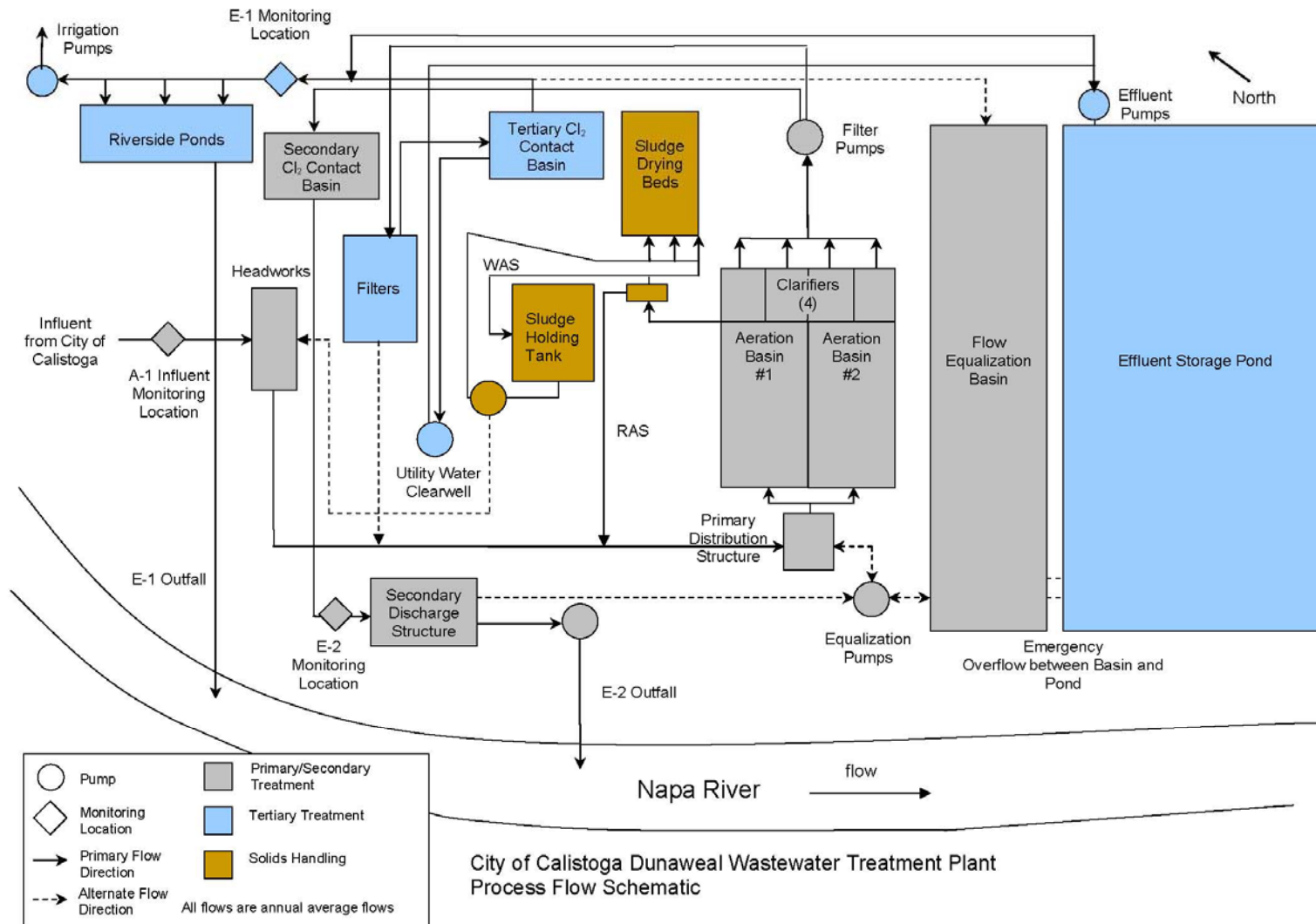

ATTACHMENT D – FEDERAL STANDARD PROVISIONS

I. STANDARD PROVISIONS – PERMIT COMPLIANCE

A. Duty to Comply

1. The Discharger must comply with all of the conditions of this Order. Any noncompliance constitutes a violation of the Clean Water Act (CWA) and the California Water Code (CWC) and is grounds for enforcement action, for permit termination, revocation and reissuance, or denial of a permit renewal application [40 CFR §122.41(a)].
2. The Discharger shall comply with effluent standards or prohibitions established under Section 307(a) of the Clean Water Act for toxic pollutants and with standards for sewage sludge use or disposal established under Section 405(d) of the CWA within the time provided in the regulations that establish these standards or prohibitions, even if this Order has not been modified to incorporate the requirement [40 CFR §122.41(a)(1)].

B. Need to Halt or Reduce Activity Not a Defense

It shall not be a defense for a Discharger in an enforcement action that it would have been necessary to halt or reduce the permitted activity in order to maintain compliance with the conditions of this Order [40 CFR §122.41(c)].

C. Duty to Mitigate

The Discharger shall take all reasonable steps to minimize or prevent any discharge or sludge use or disposal in violation of this Order that has a reasonable likelihood of adversely affecting human health or the environment [40 CFR §122.41(d)].

D. Proper Operation and Maintenance

The Discharger shall at all times properly operate and maintain all facilities and systems of treatment and control (and related appurtenances) which are installed or used by the Discharger to achieve compliance with the conditions of this Order. Proper operation and maintenance also includes adequate laboratory controls and appropriate quality assurance procedures. This provision requires the operation of backup or auxiliary facilities or similar systems that are installed by a Discharger only when necessary to achieve compliance with the conditions of this Order [40 CFR §122.41(e)].

E. Property Rights

1. This Order does not convey any property rights of any sort or any exclusive privileges [40 CFR §122.41(g)].

2. The issuance of this Order does not authorize any injury to persons or property or invasion of other private rights, or any infringement of State or local law or regulations [40 CFR §122.5(c)].

F. Inspection and Entry

The Discharger shall allow the Regional Water Quality Control Board (Regional Water Board), State Water Resources Control Board (State Water Board), United States Environmental Protection Agency (USEPA), and/or their authorized representatives (including an authorized contractor acting as their representative), upon the presentation of credentials and other documents, as may be required by law, to [40 CFR §122.41(i)] [CWC 13383(c)]:

1. Enter upon the Discharger's premises where a regulated facility or activity is located or conducted, or where records are kept under the conditions of this Order [40 CFR §122.41(i)(1)];
2. Have access to and copy, at reasonable times, any records that must be kept under the conditions of this Order [40 CFR §122.41(i)(2)];
3. Inspect and photograph, at reasonable times, any facilities, equipment (including monitoring and control equipment), practices, or operations regulated or required under this Order [40 CFR §122.41(i)(3)];
4. Sample or monitor, at reasonable times, for the purposes of assuring Order compliance or as otherwise authorized by the CWA or the CWC, any substances or parameters at any location [40 CFR §122.41(i)(4)].

G. Bypass

1. Definitions
 - a. “Bypass” means the intentional diversion of waste streams from any portion of a treatment facility [40 CFR §122.41(m)(1)(i)].
 - b. “Severe property damage” means substantial physical damage to property, damage to the treatment facilities, which causes them to become inoperable, or substantial and permanent loss of natural resources that can reasonably be expected to occur in the absence of a bypass. Severe property damage does not mean economic loss caused by delays in production [40 CFR §122.41(m)(1)(ii)].
2. Bypass not exceeding limitations – The Discharger may allow any bypass to occur which does not cause exceedances of effluent limitations, but only if it is for essential maintenance to assure efficient operation. These bypasses are not subject to the provisions listed in Standard Provisions – Permit Compliance I.G.3 and I.G.5 below [40 CFR §122.41(m)(2)].

3. Prohibition of bypass – Bypass is prohibited, and the Regional Water Board may take enforcement action against a Discharger for bypass, unless [40 CFR §122.41(m)(4)(i)]:
 - a. Bypass was unavoidable to prevent loss of life, personal injury, or severe property damage [40 CFR §122.41(m)(4)(A)];
 - b. There were no feasible alternatives to the bypass, such as the use of auxiliary treatment facilities, retention of untreated wastes, or maintenance during normal periods of equipment downtime. This condition is not satisfied if adequate back-up equipment should have been installed in the exercise of reasonable engineering judgment to prevent a bypass that occurred during normal periods of equipment downtime or preventive maintenance [40 CFR §122.41(m)(4)(B)]; and
 - c. The Discharger submitted notice to the Regional Water Board as required under Standard Provision – Permit Compliance I.G.5 below [40 CFR §122.41(m)(4)(C)].
4. The Regional Water Board may approve an anticipated bypass, after considering its adverse effects, if the Regional Water Board determines that it will meet the three conditions listed in Standard Provisions – Permit Compliance I.G.3 above [40 CFR §122.41(m)(4)(ii)].
5. Notice
 - a. Anticipated bypass. If the Discharger knows in advance of the need for a bypass, it shall submit a notice, if possible at least 10 days before the date of the bypass [40 CFR §122.41(m)(3)(i)].
 - b. Unanticipated bypass. The Discharger shall submit notice of an unanticipated bypass as required in Standard Provisions - Reporting V.E below [40 CFR §122.41(m)(3)(ii)].

H. Upset

Upset means an exceptional incident in which there is unintentional and temporary noncompliance with technology based permit effluent limitations because of factors beyond the reasonable control of the permittee. An upset does not include noncompliance to the extent caused by operational error, improperly designed treatment facilities, inadequate treatment facilities, lack of preventive maintenance, or careless or improper operation [40 CFR §122.41(n)(1)].

1. Effect of an upset. An upset constitutes an affirmative defense to an action brought for noncompliance with such technology based permit effluent limitations if the requirements of paragraph H.2 of this section are met. No determination made during administrative review of claims that noncompliance was caused by upset, and before an action for noncompliance, is final administrative action subject to judicial review [40 CFR §122.41(n)(2)].

2. Conditions necessary for a demonstration of upset. A Discharger who wishes to establish the affirmative defense of upset shall demonstrate, through properly signed, contemporaneous operating logs or other relevant evidence that [40 CFR §122.41(n)(3)]:
 - a. An upset occurred and that the Discharger can identify the cause(s) of the upset [40 CFR §122.41(n)(3)(i)];
 - b. The permitted facility was, at the time, being properly operated [40 CFR §122.41(n)(3)(i)];
 - c. The Discharger submitted notice of the upset as required in Standard Provisions – Reporting V.E.2.b [40 CFR §122.41(n)(3)(iii)]; and
 - d. The Discharger complied with any remedial measures required under Standard Provisions – Permit Compliance I.C above [40 CFR §122.41(n)(3)(iv)].
3. Burden of proof. In any enforcement proceeding, the Discharger seeking to establish the occurrence of an upset has the burden of proof [40 CFR §122.41(n)(4)].

II. STANDARD PROVISIONS – PERMIT ACTION

A. General

This Order may be modified, revoked and reissued, or terminated for cause. The filing of a request by the Discharger for modification, revocation and reissuance, or termination, or a notification of planned changes or anticipated noncompliance does not stay any Order condition [40 CFR §122.41(f)].

B. Duty to Reapply

If the Discharger wishes to continue an activity regulated by this Order after the expiration date of this Order, the Discharger must apply for and obtain a new permit [40 CFR §122.41(b)].

C. Transfers

This Order is not transferable to any person except after notice to the Regional Water Board. The Regional Water Board may require modification or revocation and reissuance of the Order to change the name of the Discharger and incorporate such other requirements as may be necessary under the CWA and the CWC [40 CFR §122.41(1)(3)] [40 CFR §122.61].

III. STANDARD PROVISIONS – MONITORING

- A. Samples and measurements taken for the purpose of monitoring shall be representative of the monitored activity [40 CFR §122.41(j)(1)].

- B. Monitoring results must be conducted according to test procedures under 40 CFR Part 136 or, in the case of sludge use or disposal, approved under 40 CFR Part 136 unless otherwise specified in 40 CFR Part 503 unless other test procedures have been specified in this Order [40 CFR §122.41(j)(4)] [40 CFR §122.44(i)(1)(iv)].

IV. STANDARD PROVISIONS – RECORDS

- A. Except for records of monitoring information required by this Order related to the Discharger's sewage sludge use and disposal activities, which shall be retained for a period of at least five years (or longer as required by 40 CFR Part 503), the Discharger shall retain records of all monitoring information, including all calibration and maintenance records and all original strip chart recordings for continuous monitoring instrumentation, copies of all reports required by this Order, and records of all data used to complete the application for this Order, for a period of at least three (3) years from the date of the sample, measurement, report or application. This period may be extended by request of the Regional Water Board Executive Officer at any time [40 CFR §122.41(j)(2)].

B. Records of monitoring information shall include:

1. The date, exact place, and time of sampling or measurements [40 CFR §122.41(j)(3)(i)];
2. The individual(s) who performed the sampling or measurements [40 CFR §122.41(j)(3)(ii)];
3. The date(s) analyses were performed [40 CFR §122.41(j)(3)(iii)];
4. The individual(s) who performed the analyses [40 CFR §122.41(j)(3)(iv)];
5. The analytical techniques or methods used [40 CFR §122.41(j)(3)(v)]; and
6. The results of such analyses [40 CFR §122.41(j)(3)(vi)].

C. Claims of confidentiality for the following information will be denied [40 CFR §122.7(b)]:

1. The name and address of any permit applicant or Discharger [40 CFR §122.7(b)(1)]; and
2. Permit applications and attachments, permits and effluent data [40 CFR §122.7(b)(2)].

V. STANDARD PROVISIONS – REPORTING

A. Duty to Provide Information

The Discharger shall furnish to the Regional Water Board, State Water Board, or USEPA within a reasonable time, any information which the Regional Water Board, State Water Board, or USEPA may request to determine whether cause exists for modifying, revoking and reissuing, or terminating this Order or to determine compliance with this Order. Upon request, the Discharger

shall also furnish to the Regional Water Board, State Water Board, or USEPA copies of records required to be kept by this Order [40 CFR §122.41(h)] [CWC 13267].

B. Signatory and Certification Requirements

1. All applications, reports, or information submitted to the Regional Water Board, State Water Board, and/or USEPA shall be signed and certified in accordance with paragraph (2.) and (3.) of this provision [40 CFR §122.41(k)].
2. All permit applications shall be signed as follows:
 - a. For a corporation: By a responsible corporate officer. For the purpose of this section, a responsible corporate officer means: (i) A president, secretary, treasurer, or vice-president of the corporation in charge of a principal business function, or any other person who performs similar policy- or decision-making functions for the corporation, or (ii) the manager of one or more manufacturing, production, or operating facilities, provided, the manager is authorized to make management decisions which govern the operation of the regulated facility including having the explicit or implicit duty of making major capital investment recommendations, and initiating and directing other comprehensive measures to assure long term environmental compliance with environmental laws and regulations; the manager can ensure that the necessary systems are established or actions taken to gather complete and accurate information for permit application requirements; and where authority to sign documents has been assigned or delegated to the manager in accordance with corporate procedures [40 CFR §122.22(a)(1)];
 - b. For a partnership or sole proprietorship: by a general partner or the proprietor, respectively [40 CFR §122.22(a)(2)]; or
 - c. For a municipality, State, federal, or other public agency: by either a principal executive officer or ranking elected official. For purposes of this provision, a principal executive officer of a federal agency includes: (i) the chief executive officer of the agency, or (ii) a senior executive officer having responsibility for the overall operations of a principal geographic unit of the agency (e.g., Regional Administrators of USEPA) [40 CFR §122.22(a)(3)].
3. All reports required by this Order and other information requested by the Regional Water Board, State Water Board, or USEPA shall be signed by a person described in paragraph (b) of this provision, or by a duly authorized representative of that person. A person is a duly authorized representative only if:
 - a. The authorization is made in writing by a person described in paragraph (2.) of this provision [40 CFR §122.22(b)(1)];

- b. The authorization specified either an individual or a position having responsibility for the overall operation of the regulated facility or activity such as the position of plant manager, operator of a well or a well field, superintendent, position of equivalent responsibility, or an individual or position having overall responsibility for environmental matters for the company (a duly authorized representative may thus be either a named individual or any individual occupying a named position) [40 CFR §122.22(b)(2)]; and
 - c. The written authorization is submitted to the Regional Water Board, State Water Board, or USEPA [40 CFR §122.22(b)(3)].
4. If an authorization under paragraph (3.) of this provision is no longer accurate because a different individual or position has responsibility for the overall operation of the facility, a new authorization satisfying the requirements of paragraph (3.) of this provision must be submitted to the Regional Water Board, State Water Board or USEPA prior to or together with any reports, information, or applications, to be signed by an authorized representative [40 CFR §122.22(c)].
 5. Any person signing a document under paragraph (2.) or (3.) of this provision shall make the following certification:

“I certify under penalty of law that this document and all attachments were prepared under my direction or supervision in accordance with a system designed to assure that qualified personnel properly gather and evaluate the information submitted. Based on my inquiry of the person or persons who manage the system or those persons directly responsible for gathering the information, the information submitted is, to the best of my knowledge and belief, true, accurate, and complete. I am aware that there are significant penalties for submitting false information, including the possibility of fine and imprisonment for knowing violations” [40 CFR §122.22(d)].

C. Monitoring Reports

1. Monitoring results shall be reported at the intervals specified in the Monitoring and Reporting Program in this Order [40 CFR §122.41(l)(4)].
2. Monitoring results must be reported on a Discharge Monitoring Report (DMR) form or forms provided or specified by the Regional Water Board or State Water Board for reporting results of monitoring of sludge use or disposal practices [40 CFR §122.41(l)(4)(i)].
3. If the Discharger monitors any pollutant more frequently than required by this Order using test procedures approved under 40 CFR Part 136 or, in the case of sludge use or disposal, approved under 40 CFR Part 136 unless otherwise specified in 40 CFR Part 503, or as specified in this Order, the results of this monitoring shall be included in the calculation and reporting of the data submitted in the DMR or sludge reporting form specified by the Regional Water Board [40 CFR §122.41(l)(4)(ii)].

4. Calculations for all limitations, which require averaging of measurements, shall utilize an arithmetic mean unless otherwise specified in this Order [40 CFR §122.41(l)(4)(iii)].

D. Compliance Schedules

Reports of compliance or noncompliance with, or any progress reports on, interim and final requirements contained in any compliance schedule of this Order, shall be submitted no later than 14 days following each schedule date [40 CFR §122.41(l)(5)].

E. Twenty-Four Hour Reporting

1. The Discharger shall report any noncompliance that may endanger health or the environment. Any information shall be provided orally within 24 hours from the time the Discharger becomes aware of the circumstances. A written submission shall also be provided within five (5) days of the time the Discharger becomes aware of the circumstances. The written submission shall contain a description of the noncompliance and its cause; the period of noncompliance, including exact dates and times, and if the noncompliance has not been corrected, the anticipated time it is expected to continue; and steps taken or planned to reduce, eliminate, and prevent reoccurrence of the noncompliance [40 CFR §122.41(l)(6)(i)].
2. The following shall be included as information that must be reported within 24 hours under this paragraph [40 CFR §122.41(l)(6)(ii)]:
 - a. Any unanticipated bypass that exceeds any effluent limitation in this Order [40 CFR §122.41(l)(6)(ii)(A)].
 - b. Any upset that exceeds any effluent limitation in this Order [40 CFR §122.41(l)(6)(ii)(B)].
 - c. Violation of a maximum daily discharge limitation for any of the pollutants listed in this Order to be reported within 24 hours [40 CFR §122.41(l)(6)(ii)(C)].
3. The Regional Water Board may waive the above-required written report under this provision on a case-by-case basis if an oral report has been received within 24 hours [40 CFR §122.41(l)(6)(iii)].

F. Planned Changes

The Discharger shall give notice to the Regional Water Board as soon as possible of any planned physical alterations or additions to the permitted facility. Notice is required under this provision only when [40 CFR §122.41(l)(1)]:

1. The alteration or addition to a permitted facility may meet one of the criteria for determining whether a facility is a new source in 40 CFR §122.29(b) [40 CFR §122.41(l)(1)(i)]; or

2. The alteration or addition could significantly change the nature or increase the quantity of pollutants discharged. This notification applies to pollutants which are subject neither to effluent limitations in this Order nor to notification requirements under 40 CFR Part 122.42(a)(1) (see Additional Provisions—Notification Levels VII.A.1) [40 CFR §122.41(l)(1)(ii)].
3. The alteration or addition results in a significant change in the Discharger's sludge use or disposal practices, and such alteration, addition, or change may justify the application of permit conditions that are different from or absent in the existing permit, including notification of additional use or disposal sites not reported during the permit application process or not reported pursuant to an approved land application plan [40 CFR §122.41(l)(1)(iii)].

G. Anticipated Noncompliance

The Discharger shall give advance notice to the Regional Water Board or State Water Board of any planned changes in the permitted facility or activity that may result in noncompliance with General Order requirements [40 CFR §122.41(l)(2)].

H. Other Noncompliance

The Discharger shall report all instances of noncompliance not reported under Standard Provisions – Reporting E.3, E.4, and E.5 at the time monitoring reports are submitted. The reports shall contain the information listed in Standard Provision – Reporting V.E [40 CFR §122.41(l)(7)].

I. Other Information

When the Discharger becomes aware that it failed to submit any relevant facts in a permit application, or submitted incorrect information in a permit application or in any report to the Regional Water Board, State Water Board, or USEPA, the Discharger shall promptly submit such facts or information [40 CFR §122.41(l)(8)].

VI. STANDARD PROVISIONS – ENFORCEMENT

- A. The CWA provides that any person who violates section 301, 302, 306, 307, 308, 318 or 405 of the Act, or any permit condition or limitation implementing any such sections in a permit issued under section 402, or any requirement imposed in a pretreatment program approved under sections 402(a)(3) or 402(b)(8) of the Act, is subject to a civil penalty not to exceed \$25,000 per day for each violation. The CWA provides that any person who negligently violates sections 301, 302, 306, 307, 308, 318, or 405 of the Act, or any condition or limitation implementing any of such sections in a permit issued under section 402 of the Act, or any requirement imposed in a pretreatment program approved under section 402(a)(3) or 402(b)(8) of the Act, is subject to criminal penalties of \$2,500 to \$25,000 per day of violation, or imprisonment of not more than one (1) year, or both. In the case of a second or subsequent conviction for a negligent violation, a

person shall be subject to criminal penalties of not more than \$50,000 per day of violation, or by imprisonment of not more than two (2) years, or both. Any person who knowingly violates such sections, or such conditions or limitations is subject to criminal penalties of \$5,000 to \$50,000 per day of violation, or imprisonment for not more than three (3) years, or both. In the case of a second or subsequent conviction for a knowing violation, a person shall be subject to criminal penalties of not more than \$100,000 per day of violation, or imprisonment of not more than six (6) years, or both. Any person who knowingly violates section 301, 302, 303, 306, 307, 308, 318 or 405 of the Act, or any permit condition or limitation implementing any of such sections in a permit issued under section 402 of the Act, and who knows at that time that he thereby places another person in imminent danger of death or serious bodily injury, shall, upon conviction, be subject to a fine of not more than \$250,000 or imprisonment of not more than 15 years, or both. In the case of a second or subsequent conviction for a knowing endangerment violation, a person shall be subject to a fine of not more than \$500,000 or by imprisonment of not more than 30 years, or both. An organization, as defined in section 309(c)(3)(B)(iii) of the Clean Water Act, shall, upon conviction of violating the imminent danger provision, be subject to a fine of not more than \$1,000,000 and can be fined up to \$2,000,000 for second or subsequent convictions [40 CFR §122.41(a)(2)] [CWC 13385 and 13387].

- B. Any person may be assessed an administrative penalty by the Regional Water Board for violating section 301, 302, 306, 307, 308, 318 or 405 of this Act, or any permit condition or limitation implementing any of such sections in a permit issued under section 402 of this Act. Administrative penalties for Class I violations are not to exceed \$10,000 per violation, with the maximum amount of any Class I penalty assessed not to exceed \$25,000. Penalties for Class II violations are not to exceed \$10,000 per day for each day during which the violation continues, with the maximum amount of any Class II penalty not to exceed \$125,000 [40 CFR §122.41(a)(3)].
- C. The CWA provides that any person who falsifies, tampers with, or knowingly renders inaccurate any monitoring device or method required to be maintained under this permit shall, upon conviction, be punished by a fine of not more than \$10,000, or by imprisonment for not more than 2 years, or both. If a conviction of a person is for a violation committed after a first conviction of such person under this paragraph, punishment is a fine of not more than \$20,000 per day of violation, or by imprisonment of not more than 4 years, or both [40 CFR §122.41(j)(5)].
- D. The CWA provides that any person who knowingly makes any false statement, representation, or certification in any record or other document submitted or required to be maintained under this Order, including monitoring reports or reports of compliance or noncompliance shall, upon conviction, be punished by a fine of not more than \$10,000 per violation, or by imprisonment for not more than six months per violation, or by both [40 CFR §122.41(k)(2)].

VII. ADDITIONAL PROVISIONS – NOTIFICATION LEVELS

A. Non-Municipal Facilities

Existing manufacturing, commercial, mining, and silvicultural dischargers shall notify the Regional Water Board as soon as they know or have reason to believe [40 CFR §122.42(a)]:

1. That any activity has occurred or will occur that would result in the discharge, on a routine or frequent basis, of any toxic pollutant that is not limited in this Order, if that discharge will exceed the highest of the following "notification levels" [40 CFR §122.42(a)(1)]:
 - a. 100 micrograms per liter ($\mu\text{g/L}$) [40 CFR §122.42(a)(1)(i)];
 - b. 200 $\mu\text{g/L}$ for acrolein and acrylonitrile; 500 $\mu\text{g/L}$ for 2,4-dinitrophenol and 2-methyl-4,6-dinitrophenol; and 1 milligram per liter (mg/L) for antimony [40 CFR §122.42(a)(1)(ii)];
 - c. Five (5) times the maximum concentration value reported for that pollutant in the Report of Waste Discharge [40 CFR §122.42(a)(1)(iii)]; or
 - d. The level established by the Regional Water Board in accordance with 40 CFR §122.44(f) [40 CFR §122.42(a)(1)(iv)].
2. That any activity has occurred or will occur that would result in the discharge, on a non-routine or infrequent basis, of any toxic pollutant that is not limited in this Order, if that discharge will exceed the highest of the following "notification levels" [40 CFR §122.42(a)(2)]:
 - a. 500 micrograms per liter ($\mu\text{g/L}$) [40 CFR §122.42(a)(2)(i)];
 - b. 1 milligram per liter (mg/L) for antimony [40 CFR §122.42(a)(2)(ii)];
 - c. Ten (10) times the maximum concentration value reported for that pollutant in the Report of Waste Discharge [40 CFR §122.42(a)(2)(iii)]; or
 - d. The level established by the Regional Water Board in accordance with 40 CFR §122.44(f) [40 CFR §122.42(a)(2)(iv)].

B. Publicly-Owned Treatment Works (POTWs)

All POTWs shall provide adequate notice to the Regional Water Board of the following [40 CFR §122.42(b)]:

1. Any new introduction of pollutants into the POTW from an indirect discharger that would be subject to Sections 301 or 306 of the CWA if it were directly discharging those pollutants [*40 CFR §122.42(b)(1)*]; and
2. Any substantial change in the volume or character of pollutants being introduced into that POTW by a source introducing pollutants into the POTW at the time of adoption of the Order [*40 CFR §122.42(b)(2)*].

Adequate notice shall include information on the quality and quantity of effluent introduced into the POTW as well as any anticipated impact of the change on the quantity or quality of effluent to be discharged from the POTW [*40 CFR §122.42(b)(3)*].

Attachment E – Monitoring and Reporting Program – Table of Contents

I. General Monitoring Provisions E-1
 II. Monitoring Locations E-3
 III. Influent Monitoring Requirements - Monitoring Location M-INF-001 E-3
 IV. Effluent Monitoring Requirements - Monitoring LocationS M-001, M-002, and M-003
 (M-003 Flow only) E-4
 V. Whole Effluent Toxicity Testing Requirements..... E-6
 VI. Land Discharge Monitoring Requirements (N/A)..... E-9
 VII. Reclamation Monitoring Requirements E-10
 VIII. Receiving Water Monitoring Requirements – Surface Water and Groundwater E-10
 IX. Other Monitoring Requirements..... E-10
 X. Reporting Requirements..... E-11
 A. General Monitoring and Reporting Requirements E-11
 B. Modifications to Part A of Self-Monitoring Program (Attachment G) E-12
 C. Self Monitoring Reports (SMRs) E-13

List of MRP Tables

Table E-1. Test Methods and Minimum Levels for Pollutants with Reasonable Potential..... E-2
 Table E-2. Description of Monitoring Stations E-3
 Table E-3. Influent Monitoring Requirements for Conventional Pollutants E-4
 Table E-4. Schedule of Sampling, Measurement, and Analysis E-4
 Table E-5. Receiving Water Monitoring Requirements E-10
 Table E-6. Discharge Dilution Ratio Monitoring..... E-11
 Table E-7. Monitoring Period E-13

ATTACHMENT E – MONITORING AND REPORTING PROGRAM (MRP)

The Code of Federal Regulations (CFR) at 40 CFR §122.48 requires that all NPDES permits specify monitoring and reporting requirements. CWC sections 13267 and 13383 also authorize the Regional Water Board to require technical and monitoring reports. This MRP establishes monitoring and reporting requirements that implement the federal and California regulations.

I. GENERAL MONITORING PROVISIONS

- A. The Discharger shall comply with the MRP for this Order as adopted by the Regional Water Board, and with all of the requirements contained in *Self-Monitoring Program, Part A*, adopted August 1993 (SMP, **Attachment G**). The MRP and SMP may be amended by the Executive Officer pursuant to USEPA regulations 40 CFR 122.62, 122.63, and 124.5. If any discrepancies exist between the MRP and SMP, the MRP prevails.
- B. Sampling is required during the entire year when discharging. All analyses shall be conducted using current USEPA methods, or that have been approved by the USEPA Regional Administrator pursuant to 40 CFR 136.4 and 40 CFR 136.5, or equivalent methods that are commercially and reasonably available, and that provide quantification of sampling parameters and constituents sufficient to evaluate compliance with applicable effluent limitations and to perform reasonable potential analysis. Equivalent methods must be more sensitive than those specified in 40 CFR 136, must be specified in the permit, and must be approved for use by the Executive Officer, following consultation with the State Water Resources Control Board's Quality Assurance Program.
- C. Sampling and analysis of additional constituents is required pursuant to Table 1 of the Regional Water Board's August 6, 2001 Letter titled *Requirement for Monitoring of Pollutants in Effluent and Receiving Water to Implement New Statewide Regulations and Policy*.
- D. *Minimum Levels*. For compliance and reasonable potential monitoring, analyses shall be conducted using the commercially available and reasonably achievable detection levels that are lower than the WQOs/WQC or the effluent limitations, whichever is lower. The objective is to provide quantification of constituents sufficient to allow evaluation of observed concentrations with respect to the Minimum Levels given below. All Minimum Levels are expressed as µg/L approximately equal to parts per billion (ppb).

Table E-1. Test Methods and Minimum Levels for Pollutants with Reasonable Potential

CTR #	Constituent	Types of Analytical Methods [a]											
		Minimum Levels (µg/L)											
		GC	GCMS	LC	Color	FAA	GFAA	ICP	ICP MS	SPGF AA	HYD RIDE	CVAA	DCP
6.	Copper						5		0.5	2			
8.	Mercury [b]								0.0005				
14.	Cyanide				5								
23.	Chlorodibromo methane	0.5											
27.	Dichlorobromo methane	0.5											

Footnotes for Table E-1:

[a] Analytical Methods / Laboratory techniques are defined as follows:

- GC = Gas Chromatography;
- GCMS = Gas Chromatography/Mass Spectrometry;
- Color = Colorimetric;
- GFAA = Graphite Furnace Atomic Absorption;
- ICPMS = Inductively Coupled Plasma/Mass Spectrometry;
- SPGFAA = Stabilized Platform Graphite Furnace Atomic Absorption (i.e. EPA 200.9); and
- CVAF = Cold Vapor Atomic Fluorescence.

[b] Use ultra-clean sampling (USEPA 1669) to the maximum extent practicable, and ultra-clean analytical methods (USEPA 1631) for mercury monitoring.

II. MONITORING LOCATIONS

The Discharger shall establish the following monitoring locations to demonstrate compliance with the effluent limitations, discharge specifications, and other requirements in this Order:

Table E-2. Description of Monitoring Stations

Discharge Point Name	Monitoring Location Name (Name in Previous Order)	Monitoring Location Description (include Latitude and Longitude when available)
--	M-INF-001 (A-001)	At a point in the treatment facility headworks at which all waste tributary to the treatment process system is present and preceding any phase of treatment.
001	M-001 (E-1)	At a point in the effluent from the tertiary treatment facilities prior to the point of discharge, and at which point treatment of the wastewater is complete, and all waste tributary to the effluent discharge outfall is present (38°33'34" N, 122°33'28" W).
002	M-002 (E-2)	At a point in the effluent from the secondary treatment facilities prior to discharge through the secondary effluent discharge outfall, at which point all waste tributary to the discharge is present (38°34'13" N, 122°33'40"W).
003	M-003	Discharge to land (including recycling).
--	R-001 (C-1)	Surface Water: At a point in the Napa River, located about 1000 feet upstream from the 001 outfall.
--	R-002 (C-2)	Surface Water: At a point in the Napa River, located about 100 feet upstream from the 001 outfall.
--	R-003 (C-3)	Surface Water: At a point in the Napa River, located at the point of discharge where the 001 outfall pipe discharges into the Napa River.
--	R-004 (C-4)	Surface Water: At a point in the Napa River, located about 100 feet downstream from the 001 outfall.
--	R-005 (C-5)	Surface Water: At a point in the Napa River, located about 100 feet downstream from the 002 outfall.
--	R-006 (C-6)	Surface Water: At a point in the Napa River, located about 1,000 feet downstream from the 002 outfall.
--	B-001	Biosolids monitoring.
--	P-001 thru P-'n'	Plant Perimeter: Points located along the perimeter boundary of the wastewater treatment plant, at about equidistant intervals, not to exceed 1000 feet.
--	L-001 through L-'n'	Pond Levees: Points located along the perimeter levees of the wastewater ponds, at about equidistant intervals not to exceed 500 feet.

III. INFLUENT MONITORING REQUIREMENTS - MONITORING LOCATION M-INF-001

1. The Discharger shall monitor the influent to the facility at M-INF-001 specified in Table E-3:

Table E-3. Influent Monitoring Requirements for Conventional Pollutants

Parameter	Units	Sample Type	Minimum Sampling Frequency
Flow Rate [1]	MGD	Continuous	Daily
BOD 5-day 20°C or CBOD	mg/L and kg/d	C-24	Weekly
Total Suspended Solids	mg/L and kg/d	C-24	Weekly
pH	standard unit	Grab	Weekly
Temperature	°C	Grab	Weekly

Legend: C-24 = 24-hour composite

Footnote for Table E-3:

[1] Flows shall be monitored continuously and the following shall be reported in monthly self-monitoring reports:

Daily: average flow rate.

Daily: total daily flow volume (million gallon or MG).

Daily: maximum and minimum flow rates and times of occurrence.

Monthly: average, maximum, and minimum.

Monthly: Total flow volume (MG).

IV. EFFLUENT MONITORING REQUIREMENTS - MONITORING LOCATIONS M-001, M-002, AND M-003 (M-003 FLOW ONLY)

The Discharger shall monitor treated wastewater at M-001 and M-002 as specified in Table E-4 below:

Table E-4. Schedule of Sampling, Measurement, and Analysis

Parameter	Units	Sample Type	Minimum Sampling Frequency
Flow Rate [1]	MGD	Continuous	Continuous
BOD 5-day 20°C or CBOD [2]	mg/L and kg/day	C-24	Weekly
Total Suspended Solids [2]	mg/L and kg/day	C-24	Weekly
Oil and Grease [3]	mg/L and kg/day	C-24	Monthly
Chlorine Residual [4]	mg/L	Grab	Continuous or 1/hour
Total Coliform [5]	MPN/100 ml	Grab	3/week
Turbidity [6]	NTU	Grab	Weekly
Dissolved Oxygen (D.O.)	mg/L and % saturation	Grab	Weekly
pH [7]	s.u.	Grab	Continuous
Temperature	°C	Grab	Weekly
Total Dissolved Solids	mg/L	Grab	Monthly

Parameter	Units	Sample Type	Minimum Sampling Frequency
(TDS) [6]			
Acute Toxicity [8]	% survival	Continuous	Monthly
Chronic Toxicity [9]	TUc	C-24	Annually
Copper	µg/L	C-24	Monthly
Mercury [10]	µg/L	C-24/Grab	Monthly
Cyanide	µg/L	Grab	Monthly
Chlorodibromomethane	µg/L	Grab	2/year
Dichlorobromomethane	µg/L	Grab	2/year
Nitrogens [11]	µg/L	C-24	Monthly
Total Phosphate	mg/L	C-24	Monthly
Standard Observations	--	--	Weekly
Other metals (antimony, arsenic, beryllium, cadmium, chromium, lead, nickel, selenium, silver, zinc, and thallium)	µg/L	According to the August 6, 2001 Letter	2/year
All other priority pollutants, including dioxins and tributyltin	µg/L or as appropriate	According to the August 6, 2001 Letter	Once during permit term

Legend:

- C-24 = 24-hour composite
3 / week = Three times per week
2 / year = Twice per year

Footnotes for Table E-4:

- [1] Flow Monitoring:
Flows shall be monitored continuously and the following shall be reported in monthly self-monitoring reports:
- a. Effluent daily average flow, daily total flow, maximum and minimum flows to Napa River outfall 001 (M-001);
 - b. Effluent daily average, daily total flow, maximum and minimum flows to Napa River outfall 002 (M-002);
 - c. Effluent daily average flow, daily total flow, maximum and minimum flows to land through 003 (M-003);
 - d. Total effluent flow, daily average, and monthly average.
 - e. Discharge duration: days and hours.
- [2] The percent removal for BOD and TSS shall be reported for each calendar month.
- [3] Each oil & grease sampling event shall consist of a composite sample comprised of three grab samples taken at equal intervals during the sampling date, with each grab sample being collected in a glass container. Each glass container used for sample collection or mixing shall be thoroughly rinsed with solvent rinsings as soon as possible after use, and the solvent rinsings shall be added to the composite sample for extraction and analysis.
- [4] Chlorine residual: The Discharger may record discrete readings from the continuous monitoring every hour on the hour, and report, on a daily basis, the maximum concentration observed following dechlorination. Total chlorine dosage (kg/day) shall be recorded on a daily basis (individual plants only).

- [5] When replicate analyses are made of a coliform sample, the reported result shall be the arithmetic mean of the replicate analysis sample.
- [6] Turbidity and TDS monitoring is required for M-001 only.
- [7] The minimum and maximum pH values for each sampling day shall be reported in monthly self-monitoring reports.
- [8] Acute bioassay test shall be performed in accordance with Section V.A of this MRP.
- [9] Critical Life Stage Toxicity Test shall be performed and reported in accordance with the Chronic Toxicity Requirements specified in Sections V.B of the MRP.
- [10] Mercury: The Discharger may, at its option, sample effluent mercury either as grab or as 24-hour composite samples. Use ultra-clean sampling (U.S. EPA 1669) to the maximum extent practicable and ultra-clean analytical methods (U.S. EPA 1631) for mercury monitoring. The Discharger may only use alternative methods if the method has an ML of 0.5 ng/L or less, and approval is obtained from the Executive Officer prior to conducting the monitoring.
- [11] The parameter 'Nitrogens' in this MRP means all of the following parameters: Ammonia Nitrogen, Unionized Nitrogen, Nitrate Nitrogen, and Total Organic Nitrogen. The unionized ammonia shall be calculated based on the total ammonia, pH, total dissolved solids or salinity, and temperature.

V. WHOLE EFFLUENT TOXICITY TESTING REQUIREMENTS

The Discharger shall monitor acute and chronic toxicity at M-001 and M-002 as follows:

A. Whole Effluent Acute Toxicity

1. Compliance with the acute toxicity effluent limitations of this Order shall be evaluated by measuring survival of test organisms exposed to 96-hour continuous flow-through bioassays.
2. Test organisms shall be fathead minnows or rainbow trout unless specified otherwise in writing by the Executive Officer.
3. Upon the effective date of the permit, all bioassays shall be performed according to the most up-to-date protocols in 40 CFR Part 136, currently in "Methods for Measuring the Acute Toxicity of Effluents and Receiving Water to Freshwater and Marine Organisms," 5th Edition.
4. If specific identifiable substances in the discharge can be demonstrated by the Discharger as being rapidly rendered harmless upon discharge to the receiving water, compliance with the acute toxicity limit may be determined after the test samples are adjusted to remove the influence of those substances. Written approval from the Executive Officer must be obtained to authorize such an adjustment.
5. Effluent used for fish bioassays must be dechlorinated prior to testing. Monitoring of the bioassay water shall include, on a daily basis, the following parameters: pH, dissolved oxygen, ammonia (if toxicity is observed), temperature, hardness, and alkalinity. These results shall be reported. If a violation of acute toxicity requirements occurs or if the control

fish survival rate is less than 90 percent, the bioassay test shall be restarted with new batches of fish and shall continue back to back until compliance is demonstrated.

B. Whole Effluent Chronic Toxicity

1. Chronic Toxicity Monitoring Requirements

- a. *Sampling.* The Discharger shall collect 24-hour composite samples of the effluent at the compliance point station specified in a table above, for critical life stage toxicity testing as indicated below. For toxicity tests requiring renewals, 24-hour composite samples collected on consecutive days are required.
- b. *Test Species.* *Ceriodaphnia dubia*. The Executive Officer may change to another test species if data suggest that another test species is more sensitive to the discharge.
- c. *Methodology.* Sample collection, handling and preservation shall be in accordance with USEPA protocols. In addition, bioassays shall be conducted in compliance with the most recently promulgated test methods, as shown in **Appendix E-1** and “Short-term Methods for Estimating the Chronic Toxicity of Effluents and Receiving Waters to Freshwater Organisms,” currently fourth Edition (EPA-821-R-02-013), with exceptions granted the Discharger by the Executive Officer and the Environmental Laboratory Accreditation Program (ELAP).
- d. *Dilution Series.* The Discharger shall conduct tests at 5%, 10%, 25%, 50%, and 100%. The "%" represents percent effluent as discharged. Samples may be buffered using the biological buffer MOPS (3-(N-Morpholino)propanesulfonic Acid) to control pH drift and ammonia toxicity that may be caused by increasing pH during the test, only with the written approval of the Executive Officer based on the Discharger’s demonstration that the ammonia will not cause toxicity in the receiving water.
- e. *Conditions for Accelerated Monitoring.* The Discharger shall accelerate monitoring to **monthly** when the following condition is exceeded:

Single sample maximum value of 10 TUc.

2. Chronic Toxicity Reporting Requirements

- a. *Routine Reporting.* Toxicity test results for the current reporting period shall include, at a minimum, for each test:
 - i. Sample date(s)
 - ii. Test initiation date
 - iii. Test species

- iv. End point values for each dilution (e.g. number of young, growth rate, percent survival)
 - v. NOEC value(s) in percent effluent
 - vi. IC15, IC25, IC40, and IC50 values (or EC15, EC25 ... etc.) in percent effluent
 - vii. TUc values (100/NOEC, 100/IC25, or 100/EC25)
 - viii. Mean percent mortality (\pm s.d.) after 96 hours in 100% effluent (if applicable)
 - ix. NOEC and LOEC values for reference toxicant test(s)
 - x. IC50 or EC50 value(s) for reference toxicant test(s)
 - xi. Available water quality measurements for each test (pH, D.O., temperature, conductivity, hardness, salinity, ammonia)
- b. *Compliance Summary.* The results of the chronic toxicity testing shall be provided in the most recent self-monitoring report and shall include a summary table of chronic toxicity data from at least eleven of the most recent samples. The information in the table shall include the items listed above under 3.a, item numbers i, iii, v, vi(IC25 or EC25), vii, and viii.
3. Chronic Toxicity Reduction Evaluation (TRE)
- a. *Generic TRE Work Plan.* In order to be prepared for responding to toxicity events, the Discharge shall prepare a generic TRE work plan within 90 days of the effective date of this Order. The Discharger shall review and update the work plan as necessary in order to remain current and applicable to the discharge and discharge facilities.
 - b. *Specific TRE Work Plan.* Within 30 days of exceeding either trigger for accelerated monitoring, the Discharge shall submit to the Regional Water Board a TRE work plan, which should be the generic work plan revised as appropriate for this toxicity event after consideration of available discharge data.
 - c. *Initiate TRE.* Within 30 days of the date of completion of the accelerated monitoring tests observed to exceed either trigger, the Discharger shall initiate a TRE in accordance with a TRE work plan that incorporates any and all comments from the Executive Officer.
 - d. The TRE shall be specific to the discharge, and be in accordance with current technical guidance and reference materials including USEPA guidance materials. The TRE shall be conducted as a tiered evaluation process, such as summarized below:

- i) Tier 1 consists of basic data collection (routine and accelerated monitoring).
 - ii) Tier 2 consists of evaluation of optimization of the treatment process including operation practices and in-plant process chemicals.
 - iii) Tier 3 consists of a toxicity identification evaluation (TIE).
 - iv) Tier 4 consists of evaluation of options for additional effluent treatment processes.
 - v) Tier 5 consists of evaluation of options for modifications of in-plant treatment processes.
 - vi) Tier 6 consists of implementation of selected toxicity control measures, and follow-up monitoring and confirmation of implementation success.
- e. The TRE may be ended at any stage if monitoring finds there is no longer consistent toxicity (complying with Effluent Limitations Section IV.A.8.a).
- f. The objective of the TIE shall be to identify the substance or combination of substances causing the observed toxicity. All reasonable efforts using currently available TIE methodologies shall be employed.
- g. As toxic substances are identified or characterized, the Discharger shall continue the TRE by determining the source(s) and evaluating alternative strategies for reducing or eliminating the substances from the discharge. All reasonable steps shall be taken to reduce toxicity to levels consistent with chronic toxicity evaluation parameters.
- h. Many recommended TRE elements parallel required or recommended efforts of source control, pollution prevention and storm water control programs. TRE efforts should be coordinated with such efforts. To prevent duplication of efforts, evidence of complying with requirements or recommended efforts of such programs may be acceptable to comply with TRE requirements.
- i. The Regional Water Board recognizes that chronic toxicity may be episodic and identification of causes of and reduction of sources of chronic toxicity may not be successful in all cases. Consideration of enforcement action by the Regional Water Board will be based in part on the Discharger's actions and efforts to identify and control or reduce sources of consistent toxicity.

VI. LAND DISCHARGE MONITORING REQUIREMENTS (N/A)

The Discharger shall perform land discharge monitoring at M-003 according to the monitoring requirements contained in Order No. 96-011.

VII. RECLAMATION MONITORING REQUIREMENTS

The Discharger shall perform monitoring at M-003 according to the monitoring requirements contained in Order No. 96-011.

VIII. RECEIVING WATER MONITORING REQUIREMENTS – SURFACE WATER AND GROUNDWATER

The Discharger shall monitor Napa River at R-001 through R-006, when there is discharge to the Napa River, as specified in Table E-5:

Table E-5. Receiving Water Monitoring Requirements [1]

Parameter	Units	Sample Type	Minimum Sampling Frequency
Turbidity	NTU	Grab	Monthly
pH	s. u.	Grab	Monthly
Temperature	°C	Grab	Monthly
Dissolved Oxygen	mg/L and % saturation	Grab	Monthly
Nitrogens [2]	mg/l as N	Grab	Monthly
Total Phosphate	mg/L	Grab	Monthly
Conductivity	µmhos	Grab	Monthly
Hardness (as CaCO ₃)	mg/L	Grab	Monthly
Salinity or TDS [3]	ppt or mg/L	Grab	Monthly
chloride	mg/L	Grab	Monthly
Water Depth	feet	--	Monthly
Standard Observations	--	Visual	Weekly

Footnotes for Table E-5:

- [1] Stations R-001 through R-006 shall be monitored monthly, and on the same day.
- [2] The parameter ‘Nitrogens’ in this MRP means all of the following parameters: Ammonia Nitrogen, Unionized Nitrogen, Nitrate Nitrogen, and Total Organic Nitrogen. The unionized ammonia shall be calculated based on the total ammonia, pH, total dissolved solids or salinity, and temperature.
- [3] The Discharger may elect to sample either total dissolved solids, salinity, or both, and shall sample the same parameter(s) through the permit term.

IX. OTHER MONITORING REQUIREMENTS

A. Discharge Dilution Ratio Monitoring

- 1. The Discharger shall monitor the dilution ratio the discharge receives while there is discharge into the river, at discharge points 001 and 002, as specified in Table E-6:

Table E-6. Discharge Dilution Ratio Monitoring

Parameter	Units	Sample Type	Minimum Sampling Frequency
River flow	Cubit feet per second (CFS) or MGD	--	daily
Dilution ratio	--	--	daily

2. River flow rate shall be measured at least daily during river discharge. Measurement is only required at one monitoring station on the river. Currently, the river flow station is located 20 feet above the E-2 outfall. The Discharger completes the river flow measurements using river depth and flow speed. The Executive Officer may require a different flow station. The monitoring station used for river flow monitoring shall be identified in the monthly self-monitoring report, and in the annual report.
3. The discharge dilution ratio (river water to wastewater) shall be reported on a daily basis.

B. Pond Levee Observation (L-001 through L-‘n’)

The Discharger shall observe the points located along the perimeter levees of the wastewater ponds, at about equidistant intervals not to exceed 500 feet as follows:

Constituent	Units	Sample Type	Minimum Sampling Frequency
Standard Observations	--	Observation	Monthly

C. Land Observation (P-001 through P-‘n’)

The Discharger shall observe the periphery of the waste treatment or disposal facilities at equidistant intervals, not to exceed 1000 feet at P-001 thru P-‘n’ as follows:

Constituent	Units	Sample Type	Minimum Sampling Frequency
Standard Observations	--	observation	Monthly
Precipitation	Inch	--	Each occurrence (report monthly)

X. REPORTING REQUIREMENTS

A. General Monitoring and Reporting Requirements

The Discharger shall comply with all Standard Provisions (**Attachments D and G**) related to monitoring, reporting, and recordkeeping, except as otherwise specified below.

B. Modifications to Part A of Self-Monitoring Program (Attachment G)

Modify Section F.4 as follows:

Self-Monitoring Reports

For each calendar month, a self-monitoring report (SMR) shall be submitted to the Regional Water Board in accordance with the requirements listed in Self-Monitoring Program, Part A. The purpose of the report is to document treatment performance, effluent quality and compliance with waste discharge requirements prescribed by this Order, as demonstrated by the monitoring program data and the Discharger's operation practices.

[And add at the end of Section F.4 the following:]

g. If the Discharger wishes to invalidate any measurement, the letter of transmittal will include a formal request to invalidate the measurement; the original measurement in question, the reason for invalidating the measurement, all relevant documentation that supports the invalidation (e.g., laboratory sheet, log entry, test results, etc.), and discussion of the corrective actions taken or planned (with a time schedule for completion), to prevent recurrence of the sampling or measurement problem. The invalidation of a measurement requires the approval of Water Board staff and will be based solely on the documentation submitted at that time.

h. Reporting Data in Electronic Format

The Discharger has the option to submit all monitoring results in an electronic reporting format approved by the Executive Officer. If the Discharger chooses to submit SMRs electronically, the following shall apply:

- 1) **Reporting Method:** The Discharger shall submit SMRs electronically via the process approved by the Executive Officer in a letter dated December 17, 1999, Official Implementation of Electronic Reporting System (ERS) and in the Progress Report letter dated December 17, 2000, or in a subsequently approved format that the Permit has been modified to include.
- 2) **Monthly or Quarterly Reporting Requirements:** For each reporting period (monthly or quarterly as specified in SMP Part B), an electronic SMR shall be submitted to the Regional Water Board in accordance with Section F.4.a-g. above. However, until USEPA approves the electronic signature or other signature technologies, Dischargers that are using the ERS must submit a hard copy of the original transmittal letter, an ERS printout of the data sheet, a violation report, and a receipt of the electronic transmittal.
- 3) **Annual Reporting Requirements:** Dischargers who have submitted data using the ERS for at least one calendar year are exempt from submitting an annual report

electronically, but a hard copy of the annual report shall be submitted according to Section F.5 below.

C. Self Monitoring Reports (SMRs)

1. At any time during the term of this permit, the State or Regional Water Board may notify the Discharger to electronically submit self-monitoring reports. Until such notification is given, the Discharger shall submit self-monitoring reports in accordance with the requirements described below.
2. The Discharger shall submit monthly and annual Self Monitoring Reports including the results of all required monitoring using USEPA-approved test methods or other test methods specified in this Order. Monthly reports shall be due on the 30th day following the end of each calendar month, covering samples collected during that calendar month; Annual reports shall be due on February 1 following each calendar year.
3. Monitoring periods for all required monitoring shall be completed according to the following schedule in Table E-8.

Table E-7. Monitoring Period

Sampling Frequency	Monitoring Period Begins On...	Monitoring Period
Continuous	Day after permit effective date	All
Weekly 3/week	Sunday following permit effective date or on permit effective date if on a Sunday	Sunday through Saturday
Monthly	First day of calendar month following permit effective date or on permit effective date if that date is first day of the month	1 st day of calendar month through last day of calendar month when there is river discharge
Quarterly	Closest of November 1, February 1 following permit effective date	November 1 through January 31. February 1 through June 15.
2 / year	November 1 following permit effective date	November 1 through June 15 when there is river discharge.
1 / 5 years	November 1 following permit effective date.	November 1 through June 15 when there is river discharge.
Each Occurrence	Anytime during the discharge event or as soon as possible after aware of the event	At a time which sampling can characterize the discharge event

4. The Discharger shall report with each sample result the applicable Minimum Level (ML) or Reporting Level (RL) and the current Method Detection Limit (MDL), as determined by the procedure in 40 CFR Part 136.

The Discharger shall report the results of analytical determinations for the presence of chemical constituents in a sample using the following reporting protocols:

- a. Sample results greater than or equal to the RL shall be reported as measured by the laboratory (i.e., the measured chemical concentration in the sample).

- b. Sample results less than the RL, but greater than or equal to the laboratory's MDL, shall be reported as "Detected, but Not Quantified," or DNQ. The estimated chemical concentration of the sample shall also be reported.
For the purposes of data collection, the laboratory shall write the estimated chemical concentration next to DNQ as well as the words "Estimated Concentration" (may be shortened to "Est. Conc."). The laboratory may, if such information is available, include numerical estimates of the data quality for the reported result. Numerical estimates of data quality may be percent accuracy (\pm a percentage of the reported value), numerical ranges (low to high), or any other means considered appropriate by the laboratory.
 - c. Sample results less than the laboratory's MDL shall be reported as "Not Detected," or ND.
 - d. The Discharger shall instruct laboratories to establish calibration standards so that the RL value (or its equivalent if there is differential treatment of samples relative to calibration standards) is the lowest calibration standard. The Discharger shall not use analytical data derived from *extrapolation* beyond the lowest point of the calibration curve.
5. The Discharger shall arrange all reported data in a tabular format. The data shall be summarized to clearly illustrate whether the facility is operating in compliance with interim and/or final effluent limitations.
 6. The Discharger shall attach a cover letter to the SMR. The information contained in the cover letter shall clearly identify violations of the WDRs; discuss corrective actions taken or planned; and the proposed time schedule for corrective actions. Identified violations must include a description of the requirement that was violated and a description of the violation.
 7. SMRs must be submitted to the Regional Water Board, signed and certified as required by the standard provisions (**Attachment D**), to the address listed below:

San Francisco Bay Regional Water Quality Control Board
1515 Clay Street, Suite 1400
Oakland, CA 94612
Attn: NPDES Division
 8. The Discharger has the option to submit all monitoring results in an electronic reporting format approved by the Executive Officer. The Electronic Reporting System (ERS) format includes, but is not limited to, a transmittal letter, summary of violation details and corrective actions, and transmittal receipt. If there are any discrepancies between the ERS requirements and the "hard copy" requirements listed in the MRP, then the approved ERS requirements supersede.

Appendix E-1

CHRONIC TOXICITY

DEFINITION OF TERMS AND SCREENING PHASE REQUIREMENTS

I. Definition of Terms

- A. No observed effect level (NOEL) for compliance determination is equal to IC_{25} or EC_{25} . If the IC_{25} or EC_{25} cannot be statistically determined, the NOEL shall be equal to the NOEC derived using hypothesis testing.
- B. Effective concentration (EC) is a point estimate of the toxicant concentration that would cause an adverse effect on a quantal, "all or nothing," response (such as death, immobilization, or serious incapacitation) in a given percent of the test organisms. If the effect is death or immobility, the term lethal concentration (LC) may be used. EC values may be calculated using point estimation techniques such as probit, logit, and Spearman-Kärber. EC_{25} is the concentration of toxicant (in percent effluent) that causes a response in 25 percent of the test organisms.
- C. Inhibition concentration (IC) is a point estimate of the toxicant concentration that would cause a given percent reduction in a nonlethal, nonquantal biological measurement, such as growth. For example, an IC_{25} is the estimated concentration of toxicant that would cause a 25 percent reduction in average young per female or growth. IC values may be calculated using a linear interpolation method such as USEPA's Bootstrap Procedure.
- D. No observed effect concentration (NOEC) is the highest tested concentration of an effluent or a toxicant at which no adverse effects are observed on the aquatic test organisms at a specific time of observation. It is determined using hypothesis testing.

II. Chronic Toxicity Screening Phase Requirements

- A. The Discharger shall perform screening phase monitoring:
 - 1. Subsequent to any significant change in the nature of the effluent discharged through changes in sources or treatment, except those changes resulting from reductions in pollutant concentrations attributable to source control efforts, or
 - 2. Prior to permit reissuance. Screening phase monitoring data shall be included in the NPDES permit application for reissuance. The information shall be as recent as possible, but may be based on screening phase monitoring conducted within 5 years before the permit expiration date.
- B. Design of the screening phase shall, at a minimum, consist of the following elements:

1. Use of test species specified in **Appendix E-2**, attached, and use of the protocols referenced in those tables, or as approved by the Executive Officer.
 2. Two stages:
 - a. Stage 1 shall consist of a minimum of one battery of tests conducted concurrently. Selection of the type of test species and minimum number of tests shall be based on **Appendix E-2** (attached).
 - b. Stage 2 shall consist of a minimum of two test batteries conducted at a monthly frequency using the three most sensitive species based on the Stage 1 test results and as approved by the Executive Officer.
 3. Appropriate controls.
 4. Concurrent reference toxicant tests.
 5. Dilution series 100%, 50%, 25%, 10%, 5%, 0 %, where “%” is percent effluent as discharged, or as otherwise approved the Executive Officer.
- C. The Discharger shall submit a screening phase proposal acceptable to the Executive Officer. The proposal shall address each of the elements listed above. If within 30 days, the Executive Officer does not comment, the Discharge shall commence with screening phase monitoring.

Appendix E-2

SUMMARY OF TOXICITY TEST SPECIES REQUIREMENTS

Critical Life Stage Toxicity Tests for Estuarine Waters

Species	(Scientific Name)	Effect	Test Duration	Reference
Alga	<i>(Skeletonema costatum)</i> <i>(Thalassiosira pseudonana)</i>	Growth rate	4 days	1
Red alga	<i>(Champia parvula)</i>	Number of cystocarps	7–9 days	3
Giant kelp	<i>(Macrocystis pyrifera)</i>	Percent germination; germ tube length	48 hours	2
Abalone	<i>(Haliotis rufescens)</i>	Abnormal shell development	48 hours	2
Oyster Mussel	<i>(Crassostrea gigas)</i> <i>(Mytilus edulis)</i>	Abnormal shell development; percent survival	48 hours	2
Echinoderms - Urchins Sand dollar	<i>(Strongylocentrotus purpuratus, S. franciscanus)</i> <i>(Dendraster excentricus)</i>	Percent fertilization	1 hour	2
Shrimp	<i>(Mysidopsis bahia)</i>	Percent survival; growth	7 days	3
Shrimp	<i>(Holmesimysis costata)</i>	Percent survival; growth	7 days	2
Topsmelt	<i>(Atherinops affinis)</i>	Percent survival; growth	7 days	2
Silversides	<i>(Menidia beryllina)</i>	Larval growth rate; percent survival	7 days	3

Toxicity Test References:

1. American Society for Testing Materials (ASTM). 1990. Standard Guide for Conducting Static 96-Hour Toxicity Tests with Microalgae. Procedure E 1218-90. ASTM, Philadelphia, PA.
2. Short-term Methods for Estimating the Chronic Toxicity of Effluent and Receiving Waters to West Coast Marine and Estuarine Organisms. EPA/600/R-95/136. August 1995.
3. Short-term Methods for Estimating the Chronic Toxicity of Effluent and Receiving Waters to Marine and Estuarine Organisms. EPA/600/4-90/003. July 1994.

Critical Life Stage Toxicity Tests for Fresh Waters

Species	(Scientific Name)	Effect	Test Duration	Reference
Fathead minnow	<i>(Pimephales promelas)</i>	Survival; growth rate	7 days	4
Water flea	<i>(Ceriodaphnia dubia)</i>	Survival; number of young	7 days	4
Alga	<i>(Selenastrum capricornutum)</i>	Cell division rate	4 days	4

Toxicity Test Reference:

4. Short-term Methods for Estimating the Chronic Toxicity of Effluents and Receiving Waters to Freshwater Organisms, third edition. EPA/600/4-91/002. July 1994.

Toxicity Test Requirements for Stage One Screening Phase

Requirements	Receiving Water Characteristics		
	Discharges to Coast	Discharges to San Francisco Bay ^[2]	
		Ocean	Marine/Estuarine
Taxonomic diversity	1 plant 1 invertebrate 1 fish	1 plant 1 invertebrate 1 fish	1 plant 1 invertebrate 1 fish
Number of tests of each salinity type: Freshwater ^[1]	0	1 or 2	3
Marine/Estuarine	4	3 or 4	0
Total number of tests	4	5	3

[1] The freshwater species may be substituted with marine species if:

- (a) The salinity of the effluent is above 1 part per thousand (ppt) greater than 95 percent of the time, or
- (b) The ionic strength (TDS or conductivity) of the effluent at the test concentration used to determine compliance is documented to be toxic to the test species.

[2] (a) Marine/Estuarine refers to receiving water salinities greater than 1 ppt at least 95 percent of the time during a normal water year.

- (b) Fresh refers to receiving water with salinities less than 1 ppt at least 95 percent of the time during a normal water year.

Attachment F – Fact Sheet – Table of Contents

I. Permit Information F-1

II. Facility Description F-2

 A. Description of Wastewater and Sludge Treatment or Controls F-2

 B. Effluent Discharge F-4

 C. Summary of Existing Requirements and Self-Monitoring Report (SMR) Data F-4

 D. Compliance Summary F-8

III. Applicable Plans, Policies, and Regulations F-8

 A. Legal Authorities F-8

 B. California Environmental Quality Act (CEQA) F-8

 C. State and Federal Regulations, Policies, and Plans F-8

 D. Impaired Water Bodies on CWA 303(d) List F-10

 E. Other Plans, Policies and Regulations F-11

IV. Rationale For Effluent Limitations and Discharge Specifications F-12

 A. Discharge Prohibitions - Basis for Discharge Prohibitions F-12

 B. Technology-Based Effluent Limitations F-14

 C. Water Quality-Based Effluent Limitations (WQBELs) F-16

 D. Final Effluent Limitations F-35

 E. Interim Effluent Limitations F-38

 F. Comparison to Previous Permit Limitations F-43

 G. Reclamation Specifications F-43

V. Rationale for Receiving Water Limitations F-43

VI. Rationale for Monitoring and Reporting Requirements F-44

 A. Influent Monitoring F-44

 B. Effluent Monitoring F-44

 C. Whole Effluent Toxicity Testing Requirements F-45

 D. Receiving Water Monitoring F-45

VII. Rationale for Provisions F-45

 A. Standard Provisions F-45

 B. Monitoring and Reporting Requirements F-46

 C. Special Provisions F-46

VIII. Public Participation F-49

 A. Notification of Interested Parties F-49

B. Written Comments	F-50
C. Public Hearing	F-50
D. Waste Discharge Requirements Petitions.....	F-50
E. Information and Copying	F-51
F. Register of Interested Persons	F-51
G. Additional Information.....	F-51
IX. Appendices	F-51

List of Fact Sheet Tables

Table F-1. Summary of Facility Discharge Flows (2002-2005)	F-2
Table F-2. Summary of Conventional and Non-Conventional Pollutant Effluent Limitations and Data for Discharge Point 001 (E-1)	F-5
Table F-3. Summary of Conventional and Non-Conventional Pollutant Effluent Limitations and Data for Discharge Point 002 (E-2)	F-6
Table F-4. Summary of Toxic Pollutant Effluent Limitations and Data.....	F-7
Table F-5. Summary of Technology-based Effluent Limitations	F-14
Table F-6. Receiving Water Body Beneficial Uses	F-21
Table F-7. Summary of Reasonable Potential Analysis for Outfall 001.....	F-25
Table F-8. Summary of Reasonable Potential Analysis for Outfall 002.....	F-28
Table F-9. Summary of Water Quality-based Effluent Limitations for Discharge Points 001 and 002	F-35
Table F-10. Summary of Feasibility Analysis and Interim Limitations	F-40

ATTACHMENT F – FACT SHEET

As described in Section II of this Order, this Fact Sheet includes the legal requirements and technical rationale that serve as the basis for the requirements of this Order.

I. PERMIT INFORMATION

The following table summarizes administrative information related to the facility.

WDID	2 283003001
Discharger	City of Calistoga
Name of Facility	Dunaweal Wastewater Treatment Plant and its collection system
Facility Address	1185 Dunaweal Lane
	Calistoga, CA 94515
	Napa County
Facility Contact, Title and Phone	Paul Wade, Public Works Director, (707) 942-2828 and Water Systems Superintendent, 707/ 942-2837 or 942-2847
Authorized Person(s) to Sign and Submit Reports	Paul Wade, Water Systems Superintendent
Mailing Address	414 Washington Street, Calistoga, CA 94515
Billing Address	SAME
Type of Facility	POTW
Major or Minor Facility	Minor
Threat to Water Quality	--
Complexity	--
Pretreatment Program	No
Reclamation Requirements	Title 22
Facility Permitted Flow	0.84 million gallons per day (MGD) average dry weather design flow
Facility Design Flow	0.84 MGD average dry weather design flow
Watershed	Napa River
Receiving Water	Napa River
Receiving Water Type	Fresh

- A. City of Calistoga (hereinafter Discharger or City) is the owner/operator of the Dunaweal Wastewater Treatment Plant (hereinafter Facility or Plant), a POTW. The City owns and operates the property at 1185 Dunaweal Lane, Calistoga, on which the Facility is located.
- B. The Facility discharges wastewater to the Napa River, a water of the United States, and is currently regulated by Order 00-131 (the previous permit or previous Order), which was adopted on November 29, 2000 and expired on November 29, 2005. The terms of the existing Order automatically continued in effect after the permit expiration date.
- C. The Discharger filed a report of waste discharge and submitted an application for renewal of its Waste Discharge Requirements (WDRs) and National Pollutant Discharge Elimination System (NPDES) permit on May 31, 2005. The application was deemed complete on June 14, 2005.

II. FACILITY DESCRIPTION

A. Description of Wastewater and Sludge Treatment or Controls

1. The Facility has an average dry weather design flow of 0.84 million gallons per day (MGD) and can treat up to 4.0 MGD during wet weather flow events.
2. *Treatment Process.* The Discharger owns and operates the plant, which provides tertiary level treatment for domestic, commercial, and some industrial wastewater from the City of Calistoga with a current population of approximate 5,200. The Discharger upgraded its pond system to a new activated sludge system, and the new treatment units became operational in October 2003. The treatment processes consist of headworks, secondary treatment by activated sludge and clarification, tertiary treatment by coagulation and filtration, and disinfection. Here, tertiary treatment means filtration only, as the activated sludge units currently are not running under the mode to convert ammonia to nitrate. After secondary or tertiary treatment, the effluent may be discharged to the Napa River from November 1 through June 15 (previously October 1 through May 15). During the remainder of the year, the effluent is treated to tertiary standards, distributed for recycled water use, or stored for future use or disposal. A more detailed description of the treatment units and processes can be found in **Appendix F-1** of the Fact Sheet.
3. *Effluent Discharge Summary.* Over the past four years (2002 through 2005), influent flows have been at an annual average of 0.74 MGD and 3-month dry weather average of 0.58 MGD. Total effluent flows have been at an annual average of 0.77 MGD. Effluent flows to the Napa River have averaged about 178 million gallons (MG) per year, or 0.49 MGD, over about 190 discharge days per calendar year. Influent and effluent wastewater flows for 2002 through 2005 are summarized in Table F-1 below:

Table F-1. Summary of Facility Discharge Flows (2002-2005)

Year	Influent Volume (MG)	DWADF ¹ (MGD)	Effluent Discharged to Napa River (MG) – Tertiary (001)	No. of Days Discharge Occurred at 001	Effluent Discharged to Napa River (MG) – Secondary (002)	No. of Days Discharge Occurred at 002	Effluent Discharged to Land (MG)	Total Volume of Effluent Discharged ² (MG)
2002	287	0.60	121	162	35	47	129	284
2003	282	0.62	160	186	15	18	119	295
2004	248	0.51	143	192	31	28	92	265
2005	264	0.60	179	187	28	42	76	283
Average	270	0.58	151	182	27	34	104	282

[1] DWADF = 3-month Dry Weather ADF, for July, August and September.

[2] Sum of flows discharged to land and Napa River through 001 and 002.

4. *Reclamation and Limitation.* During the dry season, June 16 through October 31 (previously May 16 through September 30), discharge to the Napa River is prohibited and treated wastewater is either stored in wastewater ponds or disposed to land through a reclamation program. The Discharger currently maintains a recycled water program. Approximately 82 MG of recycled water was delivered to the City's users or applied to

City-owned sites during the 2005 dry season. All of the existing, large landscape irrigators are already connected to the Discharger's recycled water system, and the Discharger actively pursues recycled water connections for any large, proposed new developments.

However, landscape irrigation or irrigation disposal are the only disposal options available to the Discharger. Agricultural users do not want the Discharger's recycled water because of its high boron content (3 mg/L, typical). To expand the recycled water system to nearby agricultural land (primarily vineyards), boron removal would be required for a portion of the treated water. Boron removal is expensive and problematic due to complicated operational processes and the large waste stream that is produced. The estimated cost to reduce boron to 0.5 mg/L (acceptable vineyard value) and treat a fraction of the influent flow is estimated to be \$1.2 million. This cost is for a 0.3 MGD ion exchange system. Installation of boron removal system per household or sewer connection is estimated to be \$970 per household or sewer connection. Due to the high cost, the Discharger does not expect to expand its recycled water program to include agricultural irrigation for the time being.

The Discharger's reclamation activities and discharges to land are governed by Water Reclamation Requirements in a separate Order, currently Order No. 96-011; adopted by the Regional Water Board on January 17, 1996.

5. *Wet Weather Flow Handling.* The Facility has a wet weather treatment capacity of 4 MGD, and additional facilities for handling peak wet weather flows. The headworks screens are designed to handle up to 4 MGD of influent flow. Under peak flow conditions or some other emergency event, an additional 3 MGD of inflow can bypass the screens and be temporarily stored in the 6 MG equalization basin. When influent flows subside to less than 4 MGD or the problem is corrected, the equalization basin can be emptied at a maximum rate of 1 MGD or a rate matching the available treatment capacity of the aeration basins. Flows from the equalization basin are directed to the aeration basins for full treatment. The Facility and equalization basin provide containment and treatment of all wastewater flows. When combined with the 6 MG equalization basin, the peak wet weather capacity of the treatment plant should provide adequate protection to ensure that wet weather bypass to the river will not occur.
6. *Collection System.* The Discharger's wastewater collection system includes 12.7 miles of major sanitary sewer lines and various pump stations. The Discharger is in the process of developing a program for preventative maintenance and capital improvements in order to ensure adequate capacity and reliability of the collection system.
7. *Sludge Handling and Disposal.* Sludge is collected in the clarifiers and wasted periodically to maintain an optimal bacteria population. Wasting of sludge may occur continuously or at scheduled intervals. The Return Activated Sludge (RAS) is returned to the primary distribution structure and the Waste Activation Sludge (WAS) is sent to the sludge holding tank. The volume available in the sludge holding tank is 72,000 gallons. Supernatant from the sludge holding tank is sent to the primary distribution structure. From the sludge

holding tank, sludge is either pumped to the sludge drying beds or trucked off-site for further treatment. Currently, the Discharger sends its sludge to the East Bay Municipal Utilities District (EBMUD) facility for further treatment. Final biosolids disposal occurs by dump truck pickup from the sludge holding area.

In 2005, EBMUD accepted about 450,000 gallons of sludge (with about 5% solids), or about 85 dry metric tons (dmt). The Discharger also hauled about 133 dmt of biosolids to the Potrero Hills Landfill for final disposal. The land application of municipal wastewater biosolids is regulated by the USEPA under federal regulations found in 40 CFR §503 (Standards for the Use or Disposal of Sewage Sludge), published as a final rule on February 19, 1993. Disposal of the biosolids will comply with all Federal and State regulations.

8. *Storm Water.*

- a. *Regulation.* Federal Regulations for storm water discharges were promulgated by the USEPA on November 19, 1990. The regulations [40 CFR Parts 122, 123, and 124] require specific categories of industrial activity (industrial storm water) to obtain an NPDES permit and to implement Best Available Technology Economically Available (BAT) and Best Conventional Pollutant Control Technology (BCT) to control pollutants in industrial storm water discharges.
- b. *Exemption from Coverage under Statewide Industrial Storm Water General Permit.* The State Water Board adopted a statewide NPDES permit for storm water discharges associated with industrial activities (NPDES General Permit CAS000001). The Discharger is not required to be covered under the General Permit because all of the storm water captured within the wastewater treatment plant storm drain system is directed to the headworks of the Facility and treated to the standards contained in the Discharger's permit.

B. Effluent Discharge

Treated wastewater is discharged to a non-tidal reach of the Napa River through two outfalls extending from the eastern bank of the river. Outfall 001 is used for discharging tertiary treated wastewater, with a river to wastewater flow ratio of at least 10:1. Outfall 002 is used only for discharging secondary treated wastewater, with a river to wastewater flow ratio of at least 50:1. The river to wastewater flow ratio may be revisited during the next permit renewal if a dilution credit is used to calculate final effluent limitations.

C. Summary of Existing Requirements and Self-Monitoring Report (SMR) Data

Effluent limitations/Discharge Specifications contained in the previous Order (00-131) for discharges from 001 and 002 and representative monitoring data from the term of the previous Order are as follows in Tables F-2 through F-4. The summary is based on the effluent data collected during November 2003 through January 2006.

Table F-2. Summary of Conventional and Non-Conventional Pollutant Effluent Limitations and Data for Discharge Point 001 (E-1)

Parameter (units) – Conventional and non-conventional pollutants	Effluent Limitation			Monitoring Data		
	Average Monthly	Average Weekly	Maximum Daily	Minimum daily	Maximum daily	Average
BOD ₅ (mg/L)	10	--	20	<5	10	2.6
BOD ₅ Monthly Removal (%)	85%	--	--	95.0 (monthly)	99.1 (monthly)	97.1
TSS (mg/L)	15	--	30	<3	11	1.9
TSS Monthly Removal (%)	85%	--	--	90.4 (monthly)	99.6 (monthly)	97.6
Oil and Grease (mg/L)	5	--	10	1.9	4.0	2.6
pH (s.u.)	--	--	6.5 (minimum) – 8.5 (maximum)	6.5	8.4	7.1
Total coliform (mpn/100 ml)	--	23 (5-sample median)	240 (single maximum)	<2	5	--
Chlorine residual (mg/L)			0.0	0.0	0.0	0.0
Turbidity (NTU)	--	--	10	0.23	5.83	1.1
Temperature (°C)	Not to cause ambient temperature to increase by more than 2.78°C			11	23	16.4
DO (mg/L)	--	--	--	2.05	8.7	5.7
Total dissolved solids (mg/)	--	--	--	51	730	539
TKN (mg/L)	--	--	--	0.099	0.71	0.39
Organic Nitrogen (mg/L)	--	--	--	0	0.6	0.27
Nitrate Nitrogen (mg/L)	--	--	--	5.6	11	11.1
Ammonia Nitrogen (mg/L)	--	--	--	<0.1	0.23	0.11
Total Phosphate	--	--	--	0.21	3.3	1.5
Acute Toxicity (% survival)	3-sample median not to fall below 90% and single sample not to fall below 70% survival			--		
	Fathead minnow (minimum survival)			95 (single sample), 95 (3-sample)		
	Stickleback (minimum survival)			80 (single sample), 95 (3-sample)		
Chronic Toxicity (TUc)	3-sample median maximum 10 TUc and single maximum 20 TUc			--	--	--
<i>Ceriodaphnia dubia</i>	Survival			1.0	1.0	--
	Reproduction			1.0	>4.0	--

Table F-3. Summary of Conventional and Non-Conventional Pollutant Effluent Limitations and Data for Discharge Point 002 (E-2)

Parameter (units) – Conventional and non-conventional pollutants	Effluent Limitation			Monitoring Data		
	Average Monthly	Average Weekly	Maximum Daily	Minimum daily	Maximum daily	Average
BOD ₅ (mg/L)	30	--	60	<5	<5	<5
BOD ₅ Monthly Removal (%)	85%	--	--	88.6 (monthly)	98.7 (monthly)	95.3
TSS (mg/L)	30	--	60	<3	7	2.4
TSS Monthly Removal (%)	85%	--	--	89.7 (monthly)	99.1 (monthly)	96.2
Oil and Grease (mg/L)	10	--	20	<3	14.4	3.7
pH (s.u.)	--	--	6.5 (minimum) – 8.5 (maximum)	6.7	7.5	7.04
Total coliform (mpn/100 ml)	--	23 (5-sample median)	240 (single maximum)	<2 (single sample)	23(single sample)	--
Chlorine residual (mg/L)			0.0	0.0	0.0	0.0
Turbidity (NTU)	--	--	10			
Temperature (C)	Not to cause ambient temperature to increase by more than 5° F			13	18	15.8
DO (mg/L)	--	--	--	2.11	7.2	4.9
DO saturation (%)	--	--	--			
Total dissolved solids (mg/L)	--	--	--	210	600	422
TKN (mg/L)	--	--	--			
Organic Nitrogen (mg/L)	--	--	--	0.11	0.8	0.46
Nitrate Nitrogen (mg/L)	--	--	--	5.2	14	7.2
Ammonia Nitrogen (mg/L)	2.0	3.0	4.0	<0.1	0.2	0.11
Total Phosphate	--	--	--	0.29	1.9	1.1
Acute Toxicity (% survival)	3-sample median not to fall below 90% and single sample not to fall below 70% survival					
	Fathead minnow (minimum survival)			95 (single sample), 95 (3-sample)		
	Stickleback (minimum survival)			90 (single sample), 95 (3-sample)		
Chronic Toxicity (TUc)	3-sample median maximum 10 TUc and single maximum 20 TUc			--	--	--
<i>Ceriodaphnia dubia</i>	Survival			1.0	1.0	--
	Reproduction			1.0	>4.0	--

Table F-4. Summary of Toxic Pollutant Effluent Limitations and Data

Parameters (units) - Priority pollutants	Effluent Limitation	Monitoring Data At 001 (E-1)			Monitoring Data At 002 (E-2)		
	Daily Max.	Average	Range	No. of Data Points	Average	Range	No. of Data Points
Antimony (µg/L)	--	10.5	10-11	2	--	12	1
Arsenic (µg/L)	--	13.7	7.5-21	17	11	7.1-16	10
Beryllium (µg/L)	--	All ND	<0.06 (all ND)	2	--	<0.2	1
Cadmium (µg/L)	--	0.06	0.05-0.2	17	0.09	0.03-0.2	10
Chromium III (µg/L)		0.15	<0.2-0.4	17	0.43	0.2-1.0	10
Chromium VI (µg/L)	--	All ND	<0.5- <0.9	4	All ND	<0.5- <0.9	3
Copper (µg/L)	18.3	4.4	1.7-9	17	5.1	2.5-8.8	10
Lead (µg/L)	4.2	0.4	0.07-1.2	17	0.36	0.11- 0.98	10
Mercury (µg/L)	--	0.0016	0.0008- 0.0031	17	0.0051	0.0042- 0.0074	10
Nickel (µg/L)	--	1.8	1.3-3	17	1.6	1.1-2.4	10
Selenium (µg/L)	--	All ND	<0.5-<5	17	All ND	<1-<5	10
Silver (µg/L)	5.3	0.014	<0.02- 0.2	17	0.074	0.02-0.2	10
Thallium (µg/L)	--	All ND	<0.03	2	--	0.04	1
Zinc (µg/L)	60.5	36	8-65	17	26	8-44	10
Cyanide (µg/L)	8.2	2.7	0.8-6.0	17	3.7	1.1-9.2	10
Dioxin TEQ (pg/L)	--	--	0- 0.000777	2	--	0- 0.00067	2
Chlordibromomethane (µg/L)	--	3.5	2.9-4.5	3	3.8	2.1-4.9	3
Dichlorobromomethane(µg/L)	--	11	9-13	3	10.5	6.5-13	3
Benzo(a)anthracene (µg/L)	6.5	All ND	<0.8- <0.9	3	All ND	<0.3- <0.33	5

Footnotes for Tables F-2, F-3, and F-4

[1] If data contains non-detected values (ND), average was calculated using half detection limits.

[2] If data contain all NDs, average was not calculated.

D. Compliance Summary

From November 2003 through January 2006, the Discharger has been able to comply with all effluent limitations except there was one exceedance of the previous zinc effluent limit of 60.5 µg/L.

III. APPLICABLE PLANS, POLICIES, AND REGULATIONS

The requirements contained in the proposed Order are based on the requirements and authorities described in this section.

A. Legal Authorities

This Order is issued pursuant to section 402 of the Federal Clean Water Act (CWA) and implementing regulations adopted by the U.S. Environmental Protection Agency (USEPA) and Chapter 5.5, Division 7 of the California Water Code (CWC). It shall serve as a NPDES permit for point source discharges from this facility to surface waters. This Order also serves as Waste Discharge Requirements (WDRs) pursuant to Article 4, Chapter 4 of the CWC for discharges that are not subject to regulation under CWA section 402.

B. California Environmental Quality Act (CEQA)

This action to adopt an NPDES permit is exempt from the provisions of the California Environmental Quality Act (Public Resources Code Section 21100, et seq.) in accordance with Section 13389 of the CWC.

C. State and Federal Regulations, Policies, and Plans

- 1. Water Quality Control Plans.** The Regional Water Board adopted a Water Quality Control Plan for the San Francisco Bay Basin (hereinafter Basin Plan) that designates beneficial uses, establishes water quality objectives, and contains implementation programs and policies to achieve those objectives for all waters addressed through the plan.
- 2. Thermal Plan.** The State Water Board adopted a *Water Quality Control Plan for Control of Temperature in the Coastal and Interstate Water and Enclosed Bays and Estuaries of California* (Thermal Plan) on May 18, 1972, and amended this plan on September 18, 1975. This plan contains temperature objectives for inland surface waters.
- 3. National Toxics Rule (NTR) and California Toxics Rule (CTR).** USEPA adopted the NTR on December 22, 1992, which was amended on May 4, 1995 and November 9, 1999. About forty criteria in the NTR applied in California. On May 18, 2000, USEPA adopted the CTR, which incorporated the NTR criteria that were applicable in California. The CTR was amended on February 13, 2001. These rules include water quality criteria (WQC) for priority pollutants and are applicable to this discharge.

4. **State Implementation Policy.** On March 2, 2000, State Water Board adopted the *Policy for Implementation of Toxics Standards for Inland Surface Waters, Enclosed Bays, and Estuaries of California* (State Implementation Policy or SIP). The SIP became effective on April 28, 2000, with respect to the priority pollutant criteria promulgated for California by the USEPA through the NTR and to the priority pollutant objectives established by the Regional Water Boards in their basin plans, with the exception of the provision on alternate test procedures for individual discharges that have been approved by USEPA Regional Administrator. The alternate test procedures provision was effective on May 22, 2000. The SIP became effective on May 18, 2000. The State Water Board subsequently amended the SIP on February 24, 2005, and the amendments became effective on July 31, 2005. The SIP includes procedures for determining the need for and calculating WQBELs and requires dischargers to submit data sufficient to do so. Requirements of This Order implement the SIP.
5. **Alaska Rule.** On March 30, 2000, USEPA revised its regulation that specifies when new and revised state and tribal water quality standards (WQS) become effective for CWA purposes. (40 C.F.R. § 131.21; 65 Fed. Reg. 24641 (April 27, 2000).) Under the revised regulation (also known as the Alaska rule), new and revised standards submitted to USEPA after May 30, 2000, must be approved by USEPA before being used for CWA purposes. The final rule also provides that standards already in effect and submitted to USEPA by May 30, 2000 may be used for CWA purposes, whether or not approved by USEPA.
6. **Stringency of Requirements for Individual Pollutants.** This Order contains restrictions on individual pollutants that are no more stringent than required by the federal CWA. Individual pollutant restrictions consist of technology-based restrictions and water quality-based effluent limitations. The technology-based effluent limitations consist of restrictions on CBOD, TSS, Oil and Grease, pH, and chlorine residual. Restrictions on these pollutants are specified in federal regulations and in the Basin Plan since before May 30, 2000, as discussed in the attached Fact Sheet, Attachment F. The permit's technology-based pollutant restrictions are no more stringent than required by the CWA. Water quality-based effluent limitations have been scientifically derived to implement water quality objectives that protect beneficial uses. Both the beneficial uses and the water quality objectives have been approved pursuant to federal law and are the applicable federal water quality standards. To the extent that toxic pollutant water quality-based effluent limitations were derived from the CTR, the CTR is the applicable standard pursuant to section 131.38. The scientific procedures for calculating the individual water quality-based effluent limitations are based on the CTR-SIP, which was approved by USEPA on May 18, 2000. Most beneficial uses and water quality objectives contained in the Basin Plan were approved under state law and submitted to and approved by USEPA prior to May 30, 2000. Any water quality objectives and beneficial uses submitted to USEPA prior to May 30, 2000, but not approved by USEPA before that date, are nonetheless "applicable water quality standards for purposes of the CWA" pursuant to section 131.21(c)(1). The remaining water quality objectives and beneficial uses implemented by this Order (specifically Arsenic, Cadmium, Chromium (VI), Copper (fresh), Lead, Nickel, Silver (CMC), Zinc) were approved by USEPA on January 5, 2005, and are applicable water quality standards pursuant to section 131.21(c)(2). Collectively, this Order's restrictions on individual

pollutants are no more stringent than required to implement the technology-based requirements of the CWA and the applicable water quality standards for purposes of the CWA.

7. **Antidegradation Policy.** Section 131.12 of 40 CFR requires that State water quality standards include an antidegradation policy consistent with the federal policy. The State Water Board established California's antidegradation policy in State Water Board Resolution 68-16, which incorporates the requirements of the federal antidegradation policy. Resolution 68-16 requires that existing water quality is maintained unless degradation is justified based on specific findings. As discussed in detail in this Fact Sheet, the permitted discharge is consistent with the antidegradation provision of 40 CFR §131.12 and State Water Board Resolution 68-16.
8. **Anti-Backsliding Requirements.** Sections 402(o)(2) and 303(d)(4) of the CWA and 40 CFR §122.44(l) prohibit backsliding in NPDES permits. These anti-backsliding provisions require that effluent limitations in a reissued permit be as stringent as those in the previous permit, with some exceptions in which limitations may be relaxed. Some effluent limitations in this Order are less stringent than those in the previous Order. As discussed in detail later in this document, this relaxation of effluent limitations is consistent with the anti-backsliding requirements of the CWA and federal regulations.
9. **Monitoring and Reporting Requirements.** Section 122.48 of 40 CFR requires that all NPDES permits specify requirements for recording and reporting monitoring results. Sections 13267 and 13383 of the CWA authorize the regional water boards to require technical and monitoring reports. The Monitoring and Reporting Program (MRP) establishes monitoring and reporting requirements to implement federal and State requirements. This MRP is provided in **Attachment E**.

D. Impaired Water Bodies on CWA 303(d) List

On June 6, 2003, USEPA approved a revised list of impaired water bodies prepared by the State. The list (hereinafter referred to as the 2002 303(d) list) was developed in accordance with Section 303(d) of the Federal Clean Water Act to identify specific water bodies where water quality standards are not expected to be met after implementation of technology-based effluent limitations on point sources. The Napa River is a tributary to San Pablo Bay and both are listed as impaired water bodies on the 2002 303(d) list. The 2002 303(d) list includes San Pablo Bay as impaired by chlordane, DDT, diazinon, dieldrin, dioxin compounds, exotic species, furan compounds, mercury, nickel, PCBs, dioxin-like PCBs, and selenium. Discharges of conservative pollutants (pollutants that do not break down readily) to Napa River could reach San Pablo Bay through sediment transport or in the water column, and may contribute to impairment of San Pablo Bay. The 2002 303(d) list includes the Napa River as impaired by sediment, pathogens, and nutrients.

1. Total Maximum Daily Loads

The Regional Water Board plans to adopt Total Maximum Daily Loads (TMDLs) for pollutants on the 303(d) list in the Napa River and San Pablo Bay within the next ten years. Future review of the 303(d)-list for San Francisco Bay may result in revision of the schedules or provide schedules for other pollutants.

2. Waste Load Allocations

The TMDLs will establish waste load allocations (WLAs) for point sources and load allocations for non-point sources, and will result in achieving the water quality standards for the water bodies. Final WQBELs for 303(d)-listed pollutants in this discharge will be based on WLAs contained in the respective TMDLs.

3. Implementation Strategy

The Regional Water Board's strategy to collect water quality data and to develop TMDLs is summarized below:

- a. *Data Collection.* The Regional Water Board has given the dischargers the option to collectively assist in developing and implementing analytical techniques capable of detecting 303(d)-listed pollutants to at least their respective levels of concern or water quality objectives /water quality criteria (WQOs/WQC). This collective effort may include development of sample concentration techniques for approval by the USEPA. The Regional Water Board will require dischargers to characterize the pollutant loads from their facilities into the water-quality limited water bodies. The results will be used in the development of TMDLs, and may be used to update or revise the 303(d) list or change the WQOs/WQC for the impaired water bodies.
- b. *Funding Mechanism.* The Regional Water Board has received, and anticipates continuing to receive, resources from Federal and State agencies for TMDL development. To ensure timely development of TMDLs, the Regional Water Board intends to supplement these resources by allocating development costs among dischargers through the RMP or other appropriate funding mechanisms.

E. Other Plans, Polices and Regulations

This Order is also based on the following plans, polices, and regulations:

1. The Federal *Water Pollution Control Act*, Sections 301 through 305, and 307, and amendments thereto, as applicable (CWA);
2. The State Water Board's March 2, 2000 *Policy for the USEPA's May 18, 2000 Water Quality Standards; Establishment of Numeric Criteria for Priority Toxic Pollutants for the State of California* or CTR;
3. The USEPA's *Quality Criteria for Water* [EPA 440/5-86-001, 1986] and subsequent amendments (the USEPA Gold Book);

4. Applicable Federal Regulations [40 CFR §§ 122 and 131];
5. 40 CFR §131.36(b) and amendments [Federal Register Volume 60, Number 86, 4 May 1995, pages 22229-22237];
6. USEPA's December 10, 1998 National Recommended Water Quality Criteria compilation [Federal Register Vol. 63, No. 237, pp. 68354-68364];
7. USEPA's December 27, 2002 Revision of National Recommended Water Quality Criteria compilation [Federal Register Vol. 67, No. 249, pp. 79091-79095]; and
8. Guidance provided with State Water Board actions remanding permits to the Regional Water Board for further consideration.

IV. RATIONALE FOR EFFLUENT LIMITATIONS AND DISCHARGE SPECIFICATIONS

The CWA requires point source discharges to control the amount of conventional, non-conventional, and toxic pollutants that are discharged into the waters of the United States. The control of pollutants discharged is established through effluent limitations; and other requirements in NPDES permits. There are two principal bases for effluent limitations: 1) 40 CFR §122.44(a) requires that permits include applicable technology-based limitations and standards; and 2) 40 CFR §122.44(d) requires that permits include water quality-based effluent limitations to attain and maintain applicable numeric and narrative water quality criteria to protect the beneficial uses of the receiving water. Where numeric water quality objectives have not been established, three options exist to protect water quality: 1) 40 CFR §122.44(d) specifies that where RP exists, WQBELs may be established using USEPA criteria guidance under CWA section 304(a); 2) proposed State criteria or a State policy interpreting narrative criteria supplemented with other relevant information may be used; or 3) an indicator parameter may be established.

Several specific factors affecting the development of limitations and requirements in this Order are discussed as follows:

A. Discharge Prohibitions - Basis for Discharge Prohibitions

1. Discharge Prohibition III.A. (no discharge other than that described in this Order, and no discharges receiving less than 10:1 dilution): This prohibition is the same as in the previous permit. The first part of the prohibition is based on CWC Section 13260, which requires filing of a report of waste discharge (ROWD) before discharges can occur. The Discharger submitted a ROWD for the discharges described in this Order; therefore discharges not described in this Order are prohibited. The second part is based on Basin Plan. The Basin Plan prohibits discharges with constituents of concern not receiving a minimum 10:1 initial dilution (Chapter 4, Discharge Prohibition No. 1). The 10:1 initial dilution requirement is interim for this Order and no dilution credit is considered for effluent limit calculation. During the next permit reissuance, effluent limits may be calculated based on a justified dilution credit and the Regional Water Board may require a

higher river to wastewater flow ratio for Outfall 001, based on the justifications provided in Section C.2 below of this Fact Sheet. In addition, since the secondary effluent from Outfall 002 has lower effluent quality than the tertiary effluent, this Order maintains the 50:1 river to wastewater flow ratio from the previous permit, to minimize the impact to the receiving water from the discharge.

2. Discharge Prohibition III.B. (no bypass or overflow): These prohibitions are based on the Basin Plan. The Basin Plan prohibits the discharge of partially treated and untreated wastes (Chapter 4, Discharge Prohibition No.15). This prohibition is based on general concepts contained in Sections 13260 through 13264 of the CWC that relate to the discharge of waste to State waters without filing for and being issued a permit. Under certain circumstances, as stated in 40 CFR §122.41(m), facilities may bypass waste streams to waters of the State in order to prevent loss of life, personal injury, or severe property damage, or if there were no feasible alternatives to the bypass and the Discharger submitted notices of the anticipated bypass to waters of the State.
3. Discharge Prohibition III.C. (average dry weather flow not to exceed 0.84 MGD): This prohibition is based on the historic reliable treatment capacity of the Facility. Exceedance of the Facility's average dry weather flow design capacity may result in lowering the reliability of achieving compliance with water quality requirements, unless the Discharger demonstrates otherwise through an antidegradation study. This prohibition is based on 40 CFR §122.41(l).
4. Discharge Prohibition III.D. (no discharge during the period from June 16 through October 31, unless authorized by the Executive Officer). Discharge to the Napa River during the dry season is prohibited by the Basin Plan, Chapter 4, Discharge Prohibition No. 1. However, an exception may be authorized by the Executive Officer under certain emergency situations such as a prolonged wet season that prohibits normal reclamation.

The previous Order contains a different discharge period, from October 1 through May 15. The Discharger requested, in a memo dated May 30, 2006 (**Appendix F-2**), to extend the discharge period from the existing May 15, as long as the permitted river to effluent flow ratio is available. The Discharger's discharge record shows that it rarely discharged in October since the permitted river to effluent flow ratio is usually only available starting November. Therefore, the discharge period is shifted by one month from October 1 to November 1, and ends on June 15 instead of May 15, resulting the same length of discharge period.

5. Discharge Prohibition III.E. (discharge with an elevated temperature discharged into a receiving water that supports cold fresh water habitat is prohibited, unless such an alteration does not adversely affect the beneficial uses of the receiving water can be demonstrated). The first part of the requirement is based on the Thermal Plan. However, since the Discharger's Facility receives thermal discharges from many hot springs within its service area, the discharge always has higher temperatures than those in the receiving water. The Discharger performed a special study as required by the previous Order; the results show that the receiving water temperatures do not increase for a time period long enough or at magnitude

high enough to cause adverse impact to the beneficial uses of the river; healthy cold water fish population was observed in the vicinity of the discharge. This requirement is unchanged from the previous Order.

6. Discharge Prohibition III.F. (No sanitary sewer overflows (SSO) to waters of the United States): The Clean Water Act prohibits the discharge of wastewater to surface waters except as authorize under an NPDES permit. POTWs must achieve secondary treatment, at a minimum, and any more stringent limitations that are necessary to achieve water quality standards. (33U.S.C. §1311(b)(1)(B) and (C).) Thus, an SSO that results in the discharge of raw sewage, or sewage not meeting secondary treatment, to surface waters is prohibited under the Clean Water Act.

B. Technology-Based Effluent Limitations

1. Scope and Authority

Permit effluent limitations for conventional pollutants are technology-based. Technology-based effluent limits are put in place to ensure that full secondary treatment is achieved by the wastewater treatment facility, as required under 40 CFR §133.102. Effluent limits for these conventional pollutants are defined by the Basin Plan.

- Biochemical oxygen demand (BOD),
- BOD percent removal,
- Total suspended solids (TSS),
- TSS percent removal,
- pH,
- Oil and grease,
- Total chlorine residual,
- Total coliform organisms, and
- Turbidity.

2. Applicable Technology-Based Effluent Limitations

Technology-based effluent limitations are summarized in Table F-5 below.

Table F-5. Summary of Technology-based Effluent Limitations for Discharge Points 001 and 002

Parameter	Units	Effluent Limitations				
		Average Monthly	Average Weekly	Maximum Daily	Instantaneous Minimum	Instantaneous Maximum
Biochemical Oxygen Demand 5-day @ 20°C (BOD ₅) (Outfall 001)	mg/L	10	15	--	--	--

Parameter	Units	Effluent Limitations				
		Average Monthly	Average Weekly	Maximum Daily	Instantaneous Minimum	Instantaneous Maximum
Biochemical Oxygen Demand 5-day @ 20°C (BOD ₅) (Outfall 002)	mg/L	30	45	--	--	--
BOD ₅ removal	%	85	--	--	--	--
Total Suspended Solids (Outfall 002)	mg/L	15	20	--	--	--
Total Suspended Solids (Outfall 001)	mg/L	30	45	--	--	--
TSS removal	%	85	--	--	--	--
pH	standard units	--	--	--	6.5	8.5
Oil and Grease (Outfall 001)	mg/L	5	--	10	--	--
Oil and Grease (Outfall 002)	mg/L	10	--	20	--	--
Total Chlorine Residual	mg/L	--	--	--	0.0	0.0
Total Coliform	mpn/100 mL	Not to exceed 23 as 5-sample median and 240 as single maximum				
Turbidity (Outfall 001 only)	NTU	--	--	10	--	--

- a. The effluent limitations for BOD, TSS, Oil and Grease, and turbidity are technology-based limitations representative of, and intended to ensure, adequate and reliable tertiary level wastewater treatment. They are at least as stringent as the Basin Plan requirements (Chapter 4, page 4-8, and Table 4-2, at page 4-69). These limitations are unchanged from the previous permit, except daily maximum limitations for BOD and TSS are no longer required because they are inconsistent with 40 CFR 122.45(d). Instead weekly average limits are established (which are interpolated between the previous daily maximum and monthly average limits). Compliance has been demonstrated by existing Facility performance.

For discharges from Outfall 002, this Order includes the same BOD and TSS effluent limits for secondary level POTWs as in the previous permit. However, an evaluation of the receiving water dissolved oxygen (DO) data indicates that the receiving water does not achieve the minimum DO the Basin Plan requires for the river all the time. The receiving water near the discharge supports steelhead spawning; therefore, higher levels of dissolved oxygen are desirable. DO concentrations are often less than the Basin Plan requirement upstream of the City’s discharge points. There is no compelling evidence to indicate that wastewater discharged from Outfall 002 is contributing to or causing low receiving water DO concentrations. This Order includes a provision requiring the Discharger to closely monitor its secondary BOD and TSS levels, and to perform a study, under certain conditions, to demonstrate that if the BOD and TSS discharges are at the effluent limits level, there will not be an impact to the receiving water beneficial uses. Otherwise, more

stringent effluent limits for BOD and TSS may be imposed in the next permit. Effluent data for Outfall 002 suggest that the Discharger can comply with more stringent BOD and TSS effluent limits as those for Discharge 001.

- b. The effluent limitations for BOD and TSS monthly removal are technology-based. They are unchanged from the previous permit and are based on Basin Plan requirements, derived from federal requirements (40 CFR §133.102; definition in §133.101). Compliance has been demonstrated by existing Facility performance.
- c. The effluent limitation for total chlorine residual is from Chapter 4 of the Basin Plan. The Discharger may use a continuous on-line monitoring system(s) for measuring flow, chlorine, and sodium bisulfite dosage (including a safety factor) and concentration to prove that chlorine residual exceedances are false positives. If convincing evidence is provided, Regional Water Board staff may conclude that these false positives of chlorine residual exceedances are not violations of the permit limitation.
- d. Effluent Limitation for pH (minimum 6.5, maximum 8.5): These effluent limitations are technology-based and are unchanged from the previous permit. These limitations are based on the Basin Plan (Chapter 4, Table 4-2) for shallow water discharges, which are derived from federal requirements (40 CFR §133.102). These are previous permit effluent limitations and compliance has been demonstrated by existing Facility performance. The Discharger may elect to use continuous on-line monitoring system(s) for measuring pH. In this case, 40 CFR §401.17 (pH Effluent Limitations under Continuous Monitoring), and best professional judgment (BPJ) are the basis for the compliance provisions for pH limitations. Excursions of the pH effluent limitations are permitted, provided that both of the following conditions are satisfied: (i) the total time during which the pH values are outside the required range of pH values shall not exceed 7 hours and 26 minutes in any calendar month; and (ii) no individual excursion from the range of pH values shall exceed 60 minutes.
- e. The total coliform limitations require that the moving median value for the total coliform bacteria in any five consecutive samples shall not exceed 23 MPN/100ml and any single sample shall not exceed 240 MPN/100mL. These limitations are unchanged from the previous permit, and are more stringent than the Basin Plan Table 4-2 for deep water dischargers with an initial dilution of 10:1. Compliance has been demonstrated by existing Facility performance. The purpose of these effluent limitations is to ensure adequate disinfection of the discharge in order to protect beneficial uses of the receiving waters.

C. Water Quality-Based Effluent Limitations (WQBELs)

1. Scope and Authority

- a. Toxic substances are regulated by WQBELs derived from the Basin Plan, Tables 3-3 and 3-4, the CTR, the NTR, and/or best professional judgment (BPJ). WQBELs in this Order are revised and updated from the limitations in the previous permit, and their

presence in this Order is based on an evaluation of the Discharger's data as described below under the Reasonable Potential Analysis. Numeric WQBELs are required for all constituents that have a reasonable potential to cause or contribute to an excursion above any State water quality standard. Reasonable potential is determined and final WQBELs are developed using the methodology outlined in the SIP. If the Discharger demonstrates that the final limitations will be infeasible to meet and provides justification for a compliance schedule, then interim limitations are established, with a compliance schedule to achieve the final limits.

- b. Maximum Daily Effluent Limitations (MDELs) are used in this permit to protect against acute water quality effects. It is impracticable to use weekly average limitations to guard against acute effects. Although weekly averages are effective for monitoring the performance of biological wastewater treatment plants, the MDELs are necessary for preventing fish kills or mortality to aquatic organisms.
- c. NPDES regulations, the SIP, and USEPA's Technical Support Document (TSD) provide the basis to establish MDELs. NPDES regulations at 40 CFR §122.45(d) state:

"For continuous discharges all permit effluent limitations, standards, and prohibitions, including those necessary to achieve water quality standards, shall *unless impracticable* be stated as:

(1) Maximum daily and average monthly discharge limitations for all discharges other than publicly owned treatment works; and

(2) Average weekly and average monthly discharge limitations for POTWs."
(Emphasis added.)
- d. The amended SIP (p. 8, Section 1.4) requires that WQBELs be expressed as MDELs and average monthly effluent limitations (AMELs). For aquatic life-based calculations (only), the amended SIP indicates MDELs are to be used in place of average weekly limitations for POTWs.
- e. The TSD (p. 96) states that a maximum daily limitation is appropriate for two reasons:

(1) The basis for the 7-day average for POTWs derives from the secondary treatment requirements. This basis is not related to the need for assuring achievement of water quality standards.

(2) The 7-day average, which could be comprised of up to seven or more daily samples, could average out peak toxic concentrations, and therefore the discharge's potential for causing acute toxic effects would be missed. A maximum daily limitation would be toxicologically protective of potential acute toxicity impacts.

2. Dilution Credit Policy

- a. *Previous Permit Dilution Determination.* The Basin Plan classifies a deep water discharge as being discharged through an outfall with a diffuser designed to provide a minimum “initial dilution” of 10:1 in the receiving water. The Discharger does not have a diffuser on either of its outfalls; however, the Discharger has previously been allowed to discharge its effluent to the Napa River only during the wet season (October 1 through May 15), when the river to effluent flow ratio was at least 10:1 for Outfall 001 and 50:1 for Outfall 002. This scenario was considered comparable to a “deep water” discharge, and therefore, the Regional Water Board allowed a dilution credit of 10:1 (D=9). At all other times, effluent had to be stored or reclaimed.
- b. *This Permit (2006) Dilution Determination.* This Order follows the policy established in the SIP because the SIP supercedes the Basin Plan on this issue. However, the SIP does not supercede the Basin Plan’s prohibition against discharges that do not receive at least 10:1 initial dilution, or into any nontidal water (Basin Plan Table 4-1, prohibition 1). With this Order, the Regional Water Board grants the discharge an exemption to this prohibition, on the condition that the discharge occurs only when there is at least a 10:1 river to discharge flow ratio for Outfall 001 and 50:1 for Outfall 002 (Prohibition III.A). This Order specifies that the river to discharge flow ratio to be demonstrated based on river flow monitoring performed near the discharge on a daily basis. This river to discharge flow ratio is separate from the dilution credit for calculating WQBELs, which is ruled by the SIP. Therefore, only final mercury WQBELs based on zero dilution are included in this Order. For copper, cyanide, dichlorobromomethane, and chlorodibromomethane, since the compliance schedules exceed the length of the permit, therefore, these calculated final limits based on zero dilution are intended as points of reference for the feasibility demonstration and are only included in the findings of the Fact Sheet.
- c. *Future Permit Dilution Consideration*
 - (1) *Dilution Credit with a Deep Water Diffuser.* This Order allows the Discharger to opt between a diffuser study and a dilution study. If the Discharger opts to install a deep water diffuser, WQBELs for toxic pollutants calculated using a 10:1 dilution credit (D=9) may be established in the next permit. A diffuser will enable the discharge to be considered completely mixed. The SIP provides that dilution credits based on seasonal and actual receiving water flows may be granted only for completely mixed discharges (SIP at 1.4.2.1). Incompletely mixed discharges are required to conduct mixing zone studies.

If the Discharger opts to complete a mixing zone study, the results may be used as a basis for determining the river to discharge flow ratio (or dilution ratio) and dilution credit at Outfall 001 in the next permit. Considering the uncertainty in evaluating the assimilative capacity of the river, the Regional Water Board may evaluate the discharge to determine an appropriate river to discharge flow ratio at Outfall 001.

The following paragraphs illustrate a possible rationale for determining the dilution ratio, which may be more dilute than the 10:1 ratio contained in this Order. This information describes a potential approach to establishing dilution requirements if no mixing zone study is conducted.

The instream dilution ratio requirement should account for uncertainties in stream flow measurements and the assimilative capacity of the receiving water. Ambient background data were collected at a Napa River location upstream of this discharge. However, the same background data were also used to develop the effluent limits for two other downstream waste dischargers, the Town of Yountville and City of St. Helena. These three dischargers share this same stretch of the Napa River, as well as its assimilative capacity. The one part discharge to nine parts river water implied by a 10:1 dilution ratio must be split three ways. Therefore, if each discharger contributed equally, the necessary dilution ratio for each would be 30:1, considering that all three dischargers share the same stretch of the Napa River.

However, the Discharger's flow is roughly the same as the combined flows of Yountville and St. Helena. As such, with all else being equal, the instream dilution ratio necessary to offset the pollutant addition by Yountville and St. Helena would be 20:1. Hence, a minimum river to discharge flow ratio of 20:1 would be necessary to justify a 10:1 dilution credit. To account for uncertainties, a higher ratio (e.g., 25:1) may be necessary.

According to the Discharger's memo (**Appendix F-2**), increasing the river to discharge flow ratio requirement to 25:1 for Outfall 001 would require the Discharger to increase its storage capacity, thus placing a substantial economic burden on the City and its residents. In fact, the full 25:1 ratio may not be needed because the Discharger's discharge mainly contains tertiary treated wastewater, with better water quality than the other two Napa River dischargers (see Tables F-2 through F-4). Also the river has some ability to remove pollutants from the water column by natural processes (sedimentation, precipitation, degradation, etc.) before the river flows to the next discharge point. Moreover, two streams that flow into the Napa River downstream of the discharge and upstream of St. Helena and Yountville provide additional dilution, as does groundwater flow into this portion of the river (the river flow is greater at St. Helena and Yountville than at Calistoga). In addition, the Town of Yountville has committed to achieve zero discharge by 2010, thereby reducing the number of dischargers to two sharing the same stretch of river. Based on the above, and in the absence of the information to be contained in the Discharger's mixing zone study, a river to discharge flow ratio requirement of approximately 15:1 may be appropriate. Effluent limits based on a dilution credit in the next permit could be based on such a dilution ratio requirement. The Discharger may also propose a safety factor for the river to discharge ratio requirement based on its evaluation of the downstream conditions. The Regional Water Board will evaluate all the information for the next permit reissuance, as appropriate.

A minimum river to discharge flow ratio of 50:1 will be maintained during all river discharges for Outfall 002. This dilution ratio requirement is unchanged from the previous permit. The Discharger can operate its Facility under this requirement without any hardship. In addition, this requirement is also maintained to encourage maximum use of the tertiary treatment system capacity and reclamation and to limit secondary discharge to its current level.

(2) *Dilution Credit without a Deep Water Diffuser.*

- i) *Deep Water Diffuser Concerns.* In the Discharger's memo (**Appendix F-2**), it expressed concerns regarding installing a diffuser at Outfall 001. The major concerns include potential impact on threatened/endangered species (e.g., steelhead) in Napa River and the difficulty of diffuser design and operation given the river bed conditions near the outfall.
- ii) *Mixing Zone and Dilution Credit Evaluation Study.* If a diffuser evaluation study under Provision VII.C.2.c shows that it is infeasible to install a deep water diffuser, or if the Discharger does not plan to install a diffuser at either outfall (001 or 002), the Regional Water Board considers the discharge as incompletely mixed. Pursuant to Section 1.4.2.1 of the SIP, for incompletely-mixed discharges, the Discharger may demonstrate that a dilution credit is appropriate by performing a mixing zone study, such as a tracer study, a dye study, a modeling study, or monitoring upstream and downstream of the discharge to characterize the extent of actual dilution. Provision VII.C.2.d of this Order requires the Discharger to conduct a mixing zone study to justify an appropriate dilution credit. In this Order, the WQBELs are calculated with no dilution ($D=0$). WQBELs based on the demonstrated actual dilution credit may be established in the next permit.
- iii) *Dilution Ratio Requirement.* Assuming no diffuser at Outfall 001, if the mixing zone study demonstrates that a dilution credit is warranted (based on the 10:1 river to discharge flow ratio condition), the study must also account for uncertainties as described above in section 2.c.(1). A river to wastewater flow ratio above 10:1 but below 25:1 will likely need to be maintained for Outfall 001. For Outfall 002, a minimum of 50:1 river to wastewater flow ratio will be maintained for all discharges.

3. Beneficial Uses and Water Quality Criteria and Objectives

- a. The Regional Water Board adopted a Water Quality Control Plan for the San Francisco Bay Basin (hereinafter Basin Plan) that designates beneficial uses, establishes water quality objectives, and contains implementation programs and policies to achieve those objectives for all waters addressed through the plan. The applicable beneficial uses of the Napa River, in the vicinity of the discharge, are as listed in Table F-6.

Table F-6. Receiving Water Body Beneficial Uses

Discharge Point	Receiving Water Name	Beneficial Use(s)
001 and 002	Napa River	<ul style="list-style-type: none"> - Municipal and Domestic Water Supply - Agricultural Supply (AGR) - Navigation (NAV) - Water Contact Recreation (REC-1) - Non-contact Water Recreation (REC-2) - Wildlife Habitat (WILD) - Preservation of Rare and Endangered Species (RARE) - Fish Migration (MIGR) - Fish Spawning (SPWN) - Warm Freshwater Habitat (WARM) - Cold Freshwater Habitat (COLD)

b. The WQOs/WQC applicable to the receiving water of this discharge are from the Basin Plan, CTR, and NTR.

- (1) The Basin Plan specifies numeric WQOs for 10 priority toxic pollutants, as well as narrative WQOs for toxicity and bioaccumulation in order to protect beneficial uses. The pollutants for which the Basin Plan specifies numeric objectives are arsenic, cadmium, chromium (VI), copper in fresh water, and lead, mercury, nickel, silver, zinc, and total polynuclear aromatic hydrocarbons (PAHs) in salt water. The narrative toxicity objective states in part “[a]ll waters shall be maintained free of toxic substances in concentrations that are lethal to or that produce other detrimental responses in aquatic organisms.” The bioaccumulation objective states in part “[c]ontrollable water quality factors shall not cause a detrimental increase in concentrations of toxic substances found in bottom sediments or aquatic life. Effects on aquatic organisms, wildlife, and human health will be considered.” Effluent limitations and provisions contained in this Order are designed to implement these objectives, based on available information.
- (2) The CTR specifies numeric aquatic life criteria for 23 priority toxic pollutants and numeric human health criteria for 57 priority toxic pollutants. These criteria apply to inland surface waters and enclosed bays and estuaries such as San Francisco Bay, except where the Basin Plan’s Tables 3-3 and 3-4 specify numeric objectives for certain of these priority toxic pollutants. The Basin Plan’s numeric objectives apply over the CTR (except in the South Bay south of the Dumbarton Bridge).
- (3) The NTR established numeric aquatic life criteria for selenium, numeric aquatic life and human health criteria for cyanide, and numeric human health criteria for 34 toxic organic pollutants for waters of San Francisco Bay upstream to, and including, Suisun Bay and the Sacramento-San Joaquin Delta. This includes the receiving water for this Discharger.

- c. Where numeric WQOs/WQC have not been established or updated in the Basin Plan, CTR, or NTR, 40 CFR §122.44(d) and Chapter 4 of the Basin Plan specify that WQBELs may be set based on USEPA criteria, supplemented where necessary by other relevant information, to attain and maintain narrative WQC to fully protect designated beneficial uses. This Fact Sheet discusses the specific bases and rationales for the effluent limitations, and is incorporated as part of the Order.
- d. *Basin Plan Amendment.* On January 21, 2004, the Regional Water Board adopted Resolution No. R2-2004-0003 amending the Basin Plan to (1) update the dissolved WQOs for metals to be identical to the CTR WQC except for cadmium; (2) to change the Basin Plan definitions of marine, estuarine and freshwater to be consistent with the CTR definitions; (3) to update NPDES implementation provisions to be consistent with the SIP; (4) to remove settleable matter effluent limitations for POTWs, and other editorial changes. Subsequent to approval by the State Water Resources Control Board (State Water Board) and the Office of Administrative Law (OAL) (July 22, 2004, and October 4, 2004, respectively), USEPA approved the amendment on January 5, 2005.
- e. *Basin Plan and CTR Receiving Water Salinity Policy.* The Basin Plan and CTR state that the salinity characteristics (i.e., freshwater versus saltwater) of the receiving water shall be considered in determining the applicable WQOs/WQC. Freshwater criteria shall apply to discharges to waters with salinities equal to or less than 1 ppt at least 95 percent of the time. Saltwater criteria shall apply to discharges to waters with salinities equal to or greater than 10 ppt at least 95 percent of the time in a normal water year. For discharges to waters with salinities in between these two categories, or tidally influenced fresh waters that support estuarine beneficial uses, the criteria shall be the lower of the salt- or freshwater criteria (the freshwater criteria for some metals are calculated based on ambient hardness), for each substance.
- f. *Receiving Water Salinity.* The receiving waters for the subject discharge are the waters of the Napa River, which flows to San Pablo Bay. The Discharger samples at 6 receiving water stations near the discharge Outfalls 001 and 002. However, there is no salinity monitoring data. Monitoring data from January 2002 through November 2005 at the six stations for both outfalls include 192 chloride data points, ranging from 0.6 to 150 mg/L. According to a study, fresh water can have chloride ranging from 1 to 250 mg/L (salinity levels of 0.001 to 0.5 ppt [parts per thousands]). Therefore, according to both Basin Plan and CTR salinity policy, the receiving water is fresh. As a result, this Order's effluent limitations are based on the fresh water WQOs/WQC. This is also consistent with the previous permit.
- g. *Receiving Water Hardness.* Ambient hardness values are used to calculate freshwater WQOs/WQC that are hardness dependent. In determining the WQOs/WQC for this Order, Regional Water Board staff used a hardness value of 65 mg/L as CaCO₃, which is the adjusted geometric mean (AGM) of 246 hardness values obtained from the Discharger's monitoring of the Napa River during the period of January 2002 through December 2005. The AGM represents the value that 30% of the data points fall below.

The receiving water hardness data are included in **Appendix F-3** of this Fact Sheet. The following lists the procedure to calculate an AGM:

- (1) Calculate the logarithms of each hardness value.
- (2) Calculate the arithmetic mean of the logarithms.
- (3) Calculate the standard deviation (*s*) of the logarithms.
- (4) Calculate the standard error (SE) of the arithmetic mean:

$$SE = s / \sqrt{n}$$

where *n* is the number of data points

- (5) Calculate *A* = arithmetic mean - $t_{0.7} \times SE$
where $t_{0.7}$ is the value of Student's *t* statistics for a one-sided probability of 0.7 with *n*-1 degrees of freedom, *n*-sample size.
- (6) Take the antilogarithm of *A*, antilog *A* is the AGM.

3. Determining the Need for WQBELs

- a. As specified in 40 CFR §122.44(d)(1)(i), permits are required to include WQBELs for all pollutants “which the Director determines are or may be discharged at a level which will cause, have the reasonable potential to cause, or contribute to an excursion above any State water quality standard.” Using the method prescribed in Section 1.3 of the SIP, the Regional Water Board has analyzed the effluent data to determine whether the discharge, which is the subject of this Order, has a reasonable potential to cause or contribute to an excursion above an applicable water quality standard (reasonable potential analysis or RPA). For all parameters that have reasonable potential, numeric WQBELs are required. The RPA compares the effluent data with numeric and narrative WQOs in the Basin Plan and numeric WQC from the NTR and the CTR.

- (1) *WQOs and WQC*. The RPA uses Basin Plan WQOs, including narrative toxicity objectives in the Basin Plan and applicable WQC in the CTR/NTR. **Appendix F-4** shows the applicable WQOs/WQC for this discharge.
- (2) *Methodology*. The RPA uses the methods and procedures prescribed in Section 1.3 of the SIP. Regional Water Board staff has analyzed the effluent and background data and the nature of facility operations to determine if the discharge has reasonable potential to cause or contribute to exceedences of applicable WQOs or WQC. **Appendix F-5** of this Fact Sheet shows the step-wise process described in Section 1.3 of the SIP.
- (3) Ambient background values are used in the reasonable potential analysis and in the calculation of effluent limitations. For the RPA, ambient background concentrations are the observed maximum water column concentrations. The SIP states that for calculating WQBELs, ambient background concentrations are either the observed maximum ambient water column concentrations or, for criteria/objectives intended to protect human health from carcinogenic effects, the arithmetic mean of observed ambient water concentrations. By letter dated August 6, 2001, the Executive Officer

required the Discharger to conduct additional ambient monitoring pursuant to section 13267 of the California Water Code. On March 5, 2003, a group of five dischargers to the Napa River, including the Discharger, submitted the Collaborative Napa River Receiving Water Evaluation Study. Ambient data collected in 2002 from the Napa River Station near Napa were used in evaluating background water quality for this Order.

- b. *Reasonable Potential Methodology.* The method for determining reasonable potential involves identifying the observed maximum pollutant concentration in the effluent (MEC) for each constituent, based on effluent concentration data. There are three triggers in determining reasonable potential.
- (1) The first trigger (Trigger 1) is activated when the MEC is greater than or equal to the lowest applicable WQO/WQC, which has been adjusted for pH, hardness (for freshwater WQO/WQC only), and translator data, if appropriate. If the MEC is greater than or equal to the adjusted WQO/WQC, then that pollutant has reasonable potential and a WQBEL is required.
 - (2) The second trigger (Trigger 2) is activated if the observed maximum ambient background concentration (B) is greater than the adjusted WQO/WQC ($B > WQO/WQC$), and either:
 - i. The MEC is less than the adjusted WQO/WQC ($MEC < WQO/WQC$) or
 - ii. The pollutant was not detected in any of the effluent samples and all the detection levels are greater than or equal to the adjusted WQO/WQC.
 - (3) The third trigger (Trigger 3) is activated if a review of other information determines that a WQBEL is required even though both MEC and B are less than the WQO/WQC, or effluent and background data are unavailable or insufficient (e.g., all nondetects). A limitation is required only under certain circumstances to protect beneficial uses.

c. *RPA Determination*

- (1) Regional Water Board staff conducted an RPA based on effluent data collected from November 2003 through January 2006 (see **Appendix F-6**), after the new treatment units were operational, and receiving water ambient background data collected in 2002 at Calistoga Station in Napa River (**Appendix F-7**), for priority pollutants using the method prescribed in Section 1.3 of the SIP.
- (2) The MECs, WQOs/WQC, basis for the WQOs/WQC, background concentrations and reasonable potential conclusions are listed in the table below for all constituents analyzed. The RPA results for some of the constituents in the CTR were not determined because of lack of an objective/criteria. Based on the RPA methodology in the SIP, the following constituents have been found to have

reasonable potential to cause or contribute to an excursion above WQOs/WQC: copper, mercury, cyanide, chlorodibromomethane, and dichlorobromomethane for both outfalls (001 and 002).

Table F-7. Summary of Reasonable Potential Analysis for Outfall 001

# in CTR	Priority Pollutants	Governing WQO/WQC (µg/L)	Basis ¹	MEC or Minimum MDL ² (µg/L)	Maximum Background or Minimum MDL ² (µg/L)	RPA Results ³
1	Antimony	4,300	CTR, hh	11	0.7	No
2	Arsenic	36	BP, fw	21	6	No
3	Beryllium	No Criteria		0.06	0.06	Uo
4	Cadmium	2.40	BP, fw	0.2	0.03	No
5a	Chromium (III)	452.69	CTR, fw	0.4	0.6	No
5b	Chromium (VI)	11.43	BP, fw	0.5	0.15	No
6	Copper	3.73	BP, fw	9	1.1	Yes
7	Lead	8.52	BP, fw	1.2	0.21	No
8	Mercury	0.025	BP, fw	0.0031	0.015	Yes
9	Nickel	8.28	BP, fw	3	4	No
10	Selenium	5.00	NTR, fw	0.5	0.3	No
11	Silver	2.24	BP, fw	0.02	0.03	No
12	Thallium	6.30	CTR, hh	0.03	0.2	No
13	Zinc	85.62	BP, fw	65	2	No
14	Cyanide	1.00	NTR, fw	6	0.197	Yes
15	Asbestos	No Criteria	CTR, hh	0.02	0.19	No
16	2,3,7,8-TCDD	1.4×10 ⁻⁸	BP, narrative	6.37×10 ⁻⁷	6.37×10 ⁻⁷	No
	TCDD TEQ	1.4×10 ⁻⁸	BP, narrative	7.77×10⁻¹⁰	6.57×10⁻¹⁰	No
17	Acrolein	780	CTR, hh	0.56	1	No
18	Acrylonitrile	0.66	CTR, hh	0.33	1	No
19	Benzene	71	CTR, hh	0.06	0.27	No
20	Bromoform	360	CTR, hh	0.4	0.1	No
21	Carbon Tetrachloride	4.4	CTR, hh	0.2	0.42	No
22	Chlorobenzene	21,000	CTR, hh	0.06	0.19	No
23	Chlorodibromomethane	34	CTR, hh	4.5	0.18	Yes
24	Chloroethane	No Criteria	CTR, hh	0.07	0.34	Uo
25	2-Chloroethylvinyl ether	No Criteria	CTR, hh	0.1	0.31	Uo
26	Chloroform	No Criteria	CTR, hh	34	0.24	Uo
27	Dichlorobromomethane	46	CTR, hh	13	0.2	Yes
28	1,1-Dichloroethane	No Criteria	CTR, hh	0.05	0.28	Uo
29	1,2-Dichloroethane	99	CTR, hh	0.06	0.18	No
30	1,1-Dichloroethylene	3.2	CTR, hh	0.06	0.37	No
31	1,2-Dichloropropane	39	CTR, hh	0.05	0.2	No
32	1,3-Dichloropropylene	1,700	CTR, hh	0.05	0.42	No

# in CTR	Priority Pollutants	Governing WQO/WQC (µg/L)	Basis ¹	MEC or Minimum MDL ² (µg/L)	Maximum Background or Minimum MDL ² (µg/L)	RPA Results ³
33	Ethylbenzene	29,000	CTR, hh	0.06	0.3	No
34	Methyl Bromide	4,000	CTR, hh	0.05	0.42	No
35	Methyl Chloride	No Criteria	CTR, hh	1	0.36	Uo
36	Methylene Chloride	1,600	CTR, hh	0.37	0.38	No
37	1,1,2,2-Tetrachloroethane	11	CTR, hh	0.06	0.3	No
38	Tetrachloroethylene	8.85	CTR, hh	0.06	0.32	No
39	Toluene	200,000	CTR, hh	0.06	0.25	No
40	1,2-Trans-Dichloroethylene	140,000	CTR, hh	0.05	0.3	No
41	1,1,1-Trichloroethane	No Criteria	CTR, hh	0.06	0.3	Uo
42	1,1,2-Trichloroethane	42	CTR, hh	0.07	0.27	No
43	Trichloroethylene	81	CTR, hh	0.06	0.29	No
44	Vinyl Chloride	525	CTR, hh	0.05	0.34	No
45	2-Chlorophenol	400	CTR, hh	0.6	0.4	No
46	2,4-Dichlorophenol	790	CTR, hh	0.7	0.3	No
47	2,4-Dimethylphenol	2,300	CTR, hh	0.9	0.3	No
48	2-Methyl- 4,6-Dinitrophenol	765	CTR, hh	0.9	0.4	No
49	2,4-Dinitrophenol	14,000	CTR, hh	0.6	0.3	No
50	2-Nitrophenol	No Criteria	CTR, hh	0.7	0.3	Uo
51	4-Nitrophenol	No Criteria	CTR, hh	0.6	0.2	Uo
52	3-Methyl 4-Chlorophenol	No Criteria	CTR, hh	0.5	0.3	Uo
53	Pentachlorophenol	7.90	CTR, hh	0.9	0.4	No
54	Phenol	4,600,000	CTR, hh	0.4	0.2	No
55	2,4,6-Trichlorophenol	6.50	CTR, hh	0.6	0.2	No
56	Acenaphthene	2,700	CTR, hh	0.03	0.17	No
57	Acenaphthylene	No Criteria	CTR, hh	0.02	0.03	Uo
58	Anthracene	110,000	CTR, hh	0.03	0.16	No
59	Benzidine	0.00054	CTR, hh	1	0.3	No
60	Benzo(a)Anthracene	0.049	CTR, hh	0.02	0.12	No
61	Benzo(a)Pyrene	0.049	CTR, hh	0.02	0.09	No
62	Benzo(b)Fluoranthene	0.049	CTR, hh	0.02	0.11	No
63	Benzo(ghi)Perylene	No Criteria	CTR, hh	0.02	0.06	Uo
64	Benzo(k)Fluoranthene	0.049	CTR, hh	0.02	0.16	No
65	Bis(2-Chloroethoxy)Methane	No Criteria	CTR, hh	0.8	0.3	Uo
66	Bis(2-Chloroethyl)Ether	1.40	CTR, hh	0.7	0.3	No
67	Bis(2-Chloroisopropyl)Ether	170,000	CTR, hh	0.6	0.6	No
68	Bis(2-Ethylhexyl)Phthalate	5.90	CTR, hh	0.5	0.6	No
69	4-Bromophenyl Phenyl Ether	No Criteria	CTR, hh	0.4	0.4	Uo
70	Butylbenzyl Phthalate	5,200	CTR, hh	0.8	0.4	No
71	2-Chloronaphthalene	4,300	CTR, hh	0.5	0.3	No

# in CTR	Priority Pollutants	Governing WQO/WQC (µg/L)	Basis ¹	MEC or Minimum MDL ² (µg/L)	Maximum Background or Minimum MDL ² (µg/L)	RPA Results ³
72	4-Chlorophenyl Phenyl Ether	No Criteria	CTR, hh	0.5	0.4	Uo
73	Chrysene	0.049	CTR, hh	0.02	0.14	No
74	Dibenzo(a,h)Anthracene	0.049	CTR, hh	0.03	0.04	No
75	1,2-Dichlorobenzene	17,000	CTR, hh	0.05	0.52	No
76	1,3-Dichlorobenzene	2,600	CTR, hh	0.07	0.36	No
77	1,4-Dichlorobenzene	2,600	CTR, hh	0.06	0.42	No
78	3,3 Dichlorobenzidine	0.077	CTR, hh	0.3	0.3	No
79	Diethyl Phthalate	120,000	CTR, hh	0.7	0.4	No
80	Dimethyl Phthalate	2,900,000	CTR, hh	0.6	0.4	No
81	Di-n-Butyl Phthalate	12,000	CTR, hh	0.6	0.4	No
82	2,4-Dinitrotoluene	9.10	CTR, hh	0.6	0.3	No
83	2,6-Dinitrotoluene	No Criteria	CTR, hh	0.5	0.3	Uo
84	Di-n-Octyl Phthalate	No Criteria	CTR, hh	0.7	0.4	Uo
85	1,2-Diphenylhydrazine	0.54	CTR, hh	0.6	0.3	No
86	Fluoranthene	370	CTR, hh	0.03	0.03	No
87	Fluorene	14,000	CTR, hh	0.02	0.02	No
88	Hexachlorobenzene	0.00077	CTR, hh	0.4	0.4	No
89	Hexachlorobutadiene	50	CTR, hh	0.7	0.2	No
90	Hexachlorocyclopentadiene	17,000	CTR, hh	0.4	0.1	No
91	Hexachloroethane	8.90	CTR, hh	0.6	0.2	No
92	Indeno(1,2,3-cd)Pyrene	0.049	CTR, hh	0.02	0.04	No
93	Isophorone	600	CTR, hh	0.5	0.3	No
94	Naphthalene	No Criteria	CTR, hh	0.02	0.05	Uo
95	Nitrobenzene	1,900	CTR, hh	0.7	0.3	No
96	N-Nitrosodimethylamine	8.10	CTR, hh	0.6	0.4	No
97	N-Nitrosodi-n-Propylamine	1.40	CTR, hh	0.8	0.3	No
98	N-Nitrosodiphenylamine	16	CTR, hh	0.6	0.4	No
99	Phenanthrene	No Criteria	CTR, hh	0.02	0.03	Uo
100	Pyrene	11,000	CTR, hh	0.02	0.03	No
101	1,2,4-Trichlorobenzene	No Criteria	CTR, hh	0.6	0.3	Uo
102	Aldrin	0.00014	CTR, hh	0.002	0.003	No
103	alpha-BHC	0.013	CTR, hh	0.003	0.002	No
104	beta-BHC	0.046	CTR, hh	0.003	0.001	No
105	gamma-BHC	0.063	CTR, hh	0.002	0.001	No
106	delta-BHC	No Criteria	CTR, hh	0.002	0.001	Uo
107	Chlordane (303d listed)	0.00059	CTR, hh	0.005	0.005	No
108	4,4'-DDT (303d listed)	0.00059	CTR, hh	0.002	0.001	No
109	4,4'-DDE (linked to DDT)	0.00059	CTR, hh	0.002	0.001	No
110	4,4'-DDD	0.00084	CTR, hh	0.002	0.001	No
111	Dieldrin (303d listed)	0.00014	CTR, hh	0.002	0.002	No
112	alpha-Endosulfan	0.0087	CTR, hh	0.002	0.002	No

# in CTR	Priority Pollutants	Governing WQO/WQC (µg/L)	Basis ¹	MEC or Minimum MDL ² (µg/L)	Maximum Background or Minimum MDL ² (µg/L)	RPA Results ³
113	beta-Endosulfan	0.0087	CTR, hh	0.002	0.001	No
114	Endosulfan Sulfate	240	CTR, hh	0.002	0.001	No
115	Endrin	0.0023	CTR, hh	0.002	0.002	No
116	Endrin Aldehyde	0.81	CTR, hh	0.002	0.002	No
117	Heptachlor	0.00021	CTR, hh	0.003	0.003	No
118	Heptachlor Epoxide	0.00011	CTR, hh	0.002	0.002	No
119-125	PCBs sum (2)	0.00017	CTR, hh	0.07	0.34	No
126	Toxaphene	0.00020	CTR, hh	0.15	0.2	No
	Tributyltin	0.072	BP, fw	0.000482	0.00139	No

Table F-8. Summary of Reasonable Potential Analysis for Outfall 002

# in CTR	Priority Pollutants	Governing WQO/WQC (µg/L)	Basis ¹	MEC or Minimum MDL ² (µg/L)	Maximum Background or Minimum MDL ² (µg/L)	RPA Results ³
1	Antimony	4,300	CTR, hh	12	0.7	No
2	Arsenic	36	BP, fw	16	6	No
3	Beryllium	No Criteria		0.2	0.06	Uo
4	Cadmium	2.40	BP, fw	0.2	0.03	No
5a	Chromium (III)	452.69	CTR, fw	0.3	0.6	No
5b	Chromium (VI)	11.43	BP, fw	0.5	0.15	No
6	Copper	3.73	BP, fw	8.8	1.1	Yes
7	Lead	8.52	BP, fw	0.98	0.21	No
8	Mercury	0.025	BP, fw	0.0074	0.015	Yes
9	Nickel	8.28	BP, fw	2.4	4	No
10	Selenium	5.00	NTR, fw	0.5	0.3	No
11	Silver	2.24	BP, fw	0.2	0.03	No
12	Thallium	6.30	CTR, hh	0.04	0.2	No
13	Zinc	85.62	BP, fw	44	2	No
14	Cyanide	1.00	NTR, fw	9.2	0.197	Yes
15	Asbestos	No Criteria	CTR, hh	0.02	0.19	No
16	2,3,7,8-TCDD	1.4×10 ⁻⁸	BP, narrative	6.37×10 ⁻⁷	6.37×10 ⁻⁷	No
	TCDD TEQ	1.4×10 ⁻⁸	BP, narrative	6.7×10⁻¹⁰	6.57×10⁻¹⁰	No
17	Acrolein	780	CTR, hh	0.56	1	No
18	Acrylonitrile	0.66	CTR, hh	0.33	1	No
19	Benzene	71	CTR, hh	0.06	0.27	No

# in CTR	Priority Pollutants	Governing WQO/WQC (µg/L)	Basis ¹	MEC or Minimum MDL ² (µg/L)	Maximum Background or Minimum MDL ² (µg/L)	RPA Results ³
20	Bromoform	360	CTR, hh	0.8	0.1	No
21	Carbon Tetrachloride	4.4	CTR, hh	0.06	0.42	No
22	Chlorobenzene	21,000	CTR, hh	0.06	0.19	No
23	Chlorodibromomethane	34	CTR, hh	11	0.18	Yes
24	Chloroethane	No Criteria	CTR, hh	3.1	0.34	Uo
25	2-Chloroethylvinyl ether	No Criteria	CTR, hh	0.1	0.31	Uo
26	Chloroform	No Criteria	CTR, hh	34	0.24	Uo
27	Dichlorobromomethane	46	CTR, hh	22	0.2	Yes
28	1,1-Dichloroethane	No Criteria	CTR, hh	0.05	0.28	Uo
29	1,2-Dichloroethane	99	CTR, hh	0.06	0.18	No
30	1,1-Dichloroethylene	3.2	CTR, hh	0.06	0.37	No
31	1,2-Dichloropropane	39	CTR, hh	0.05	0.2	No
32	1,3-Dichloropropylene	1,700	CTR, hh	0.05	0.42	No
33	Ethylbenzene	29,000	CTR, hh	0.06	0.3	No
34	Methyl Bromide	4,000	CTR, hh	0.6	0.42	No
35	Methyl Chloride	No Criteria	CTR, hh	95	0.36	Uo
36	Methylene Chloride	1,600	CTR, hh	0.5	0.38	No
37	1,1,2,2-Tetrachloroethane	11	CTR, hh	0.06	0.3	No
38	Tetrachloroethylene	8.85	CTR, hh	0.06	0.32	No
39	Toluene	200,000	CTR, hh	1.7	0.25	No
40	1,2-Trans-Dichloroethylene	140,000	CTR, hh	0.05	0.3	No
41	1,1,1-Trichloroethane	No Criteria	CTR, hh	0.06	0.3	Uo
42	1,1,2-Trichloroethane	42	CTR, hh	0.07	0.27	No
43	Trichloroethylene	81	CTR, hh	0.06	0.29	No
44	Vinyl Chloride	525	CTR, hh	0.05	0.34	No
45	2-Chlorophenol	400	CTR, hh	0.6	0.4	No
46	2,4-Dichlorophenol	790	CTR, hh	0.7	0.3	No
47	2,4-Dimethylphenol	2,300	CTR, hh	0.9	0.3	No
48	2-Methyl- 4,6-Dinitrophenol	765	CTR, hh	0.9	0.4	No
49	2,4-Dinitrophenol	14,000	CTR, hh	0.6	0.3	No
50	2-Nitrophenol	No Criteria	CTR, hh	0.7	0.3	Uo
51	4-Nitrophenol	No Criteria	CTR, hh	0.6	0.2	Uo
52	3-Methyl 4-Chlorophenol	No Criteria	CTR, hh	0.5	0.3	Uo
53	Pentachlorophenol	7.90	CTR, hh	0.9	0.4	No
54	Phenol	4,600,000	CTR, hh	0.4	0.2	No
55	2,4,6-Trichlorophenol	6.50	CTR, hh	0.6	0.2	No
56	Acenaphthene	2,700	CTR, hh	0.03	0.17	No
57	Acenaphthylene	No Criteria	CTR, hh	0.02	0.03	Uo
58	Anthracene	110,000	CTR, hh	0.03	0.16	No
59	Benzidine	0.00054	CTR, hh	1	0.3	No
60	Benzo(a)Anthracene	0.049	CTR, hh	0.02	0.12	No

# in CTR	Priority Pollutants	Governing WQO/WQC (µg/L)	Basis ¹	MEC or Minimum MDL ² (µg/L)	Maximum Background or Minimum MDL ² (µg/L)	RPA Results ³
61	Benzo(a)Pyrene	0.049	CTR, hh	0.02	0.09	No
62	Benzo(b)Fluoranthene	0.049	CTR, hh	0.02	0.11	No
63	Benzo(ghi)Perylene	No Criteria	CTR, hh	0.02	0.06	Uo
64	Benzo(k)Fluoranthene	0.049	CTR, hh	0.02	0.16	No
65	Bis(2-Chloroethoxy)Methane	No Criteria	CTR, hh	0.8	0.3	Uo
66	Bis(2-Chloroethyl)Ether	1.40	CTR, hh	0.7	0.3	No
67	Bis(2-Chloroisopropyl)Ether	170,000	CTR, hh	0.6	0.6	No
68	Bis(2-Ethylhexyl)Phthalate	5.90	CTR, hh	0.5	0.6	No
69	4-Bromophenyl Phenyl Ether	No Criteria	CTR, hh	0.4	0.4	Uo
70	Butylbenzyl Phthalate	5,200	CTR, hh	0.8	0.4	No
71	2-Chloronaphthalene	4,300	CTR, hh	0.5	0.3	No
72	4-Chlorophenyl Phenyl Ether	No Criteria	CTR, hh	0.5	0.4	Uo
73	Chrysene	0.049	CTR, hh	0.02	0.14	No
74	Dibenzo(a,h)Anthracene	0.049	CTR, hh	0.03	0.04	No
75	1,2-Dichlorobenzene	17,000	CTR, hh	0.05	0.52	No
76	1,3-Dichlorobenzene	2,600	CTR, hh	0.07	0.36	No
77	1,4-Dichlorobenzene	2,600	CTR, hh	0.2	0.42	No
78	3,3 Dichlorobenzidine	0.077	CTR, hh	0.3	0.3	No
79	Diethyl Phthalate	120,000	CTR, hh	0.7	0.4	No
80	Dimethyl Phthalate	2,900,000	CTR, hh	0.6	0.4	No
81	Di-n-Butyl Phthalate	12,000	CTR, hh	0.6	0.4	No
82	2,4-Dinitrotoluene	9.10	CTR, hh	0.6	0.3	No
83	2,6-Dinitrotoluene	No Criteria	CTR, hh	0.5	0.3	Uo
84	Di-n-Octyl Phthalate	No Criteria	CTR, hh	0.7	0.4	Uo
85	1,2-Diphenylhydrazine	0.54	CTR, hh	0.6	0.3	No
86	Fluoranthene	370	CTR, hh	0.03	0.03	No
87	Fluorene	14,000	CTR, hh	0.02	0.02	No
88	Hexachlorobenzene	0.00077	CTR, hh	0.4	0.4	No
89	Hexachlorobutadiene	50	CTR, hh	0.7	0.2	No
90	Hexachlorocyclopentadiene	17,000	CTR, hh	0.4	0.1	No
91	Hexachloroethane	8.90	CTR, hh	0.6	0.2	No
92	Indeno(1,2,3-cd)Pyrene	0.049	CTR, hh	0.02	0.04	No
93	Isophorone	600	CTR, hh	0.5	0.3	No
94	Naphthalene	No Criteria	CTR, hh	0.02	0.05	Uo
95	Nitrobenzene	1,900	CTR, hh	0.7	0.3	No
96	N-Nitrosodimethylamine	8.10	CTR, hh	0.6	0.4	No
97	N-Nitrosodi-n-Propylamine	1.40	CTR, hh	0.8	0.3	No
98	N-Nitrosodiphenylamine	16	CTR, hh	0.6	0.4	No
99	Phenanthrene	No Criteria	CTR, hh	0.02	0.03	Uo

# in CTR	Priority Pollutants	Governing WQO/WQC (µg/L)	Basis ¹	MEC or Minimum MDL ² (µg/L)	Maximum Background or Minimum MDL ² (µg/L)	RPA Results ³
100	Pyrene	11,000	CTR, hh	0.02	0.03	No
101	1,2,4-Trichlorobenzene	No Criteria	CTR, hh	0.6	0.3	Uo
102	Aldrin	0.00014	CTR, hh	0.002	0.003	No
103	alpha-BHC	0.013	CTR, hh	0.003	0.002	No
104	beta-BHC	0.046	CTR, hh	0.003	0.001	No
105	gamma-BHC	0.063	CTR, hh	0.002	0.001	No
106	delta-BHC	No Criteria	CTR, hh	0.002	0.001	Uo
107	Chlordane (303d listed)	0.00059	CTR, hh	0.005	0.005	No
108	4,4'-DDT (303d listed)	0.00059	CTR, hh	0.002	0.001	No
109	4,4'-DDE (linked to DDT)	0.00059	CTR, hh	0.002	0.001	No
110	4,4'-DDD	0.00084	CTR, hh	0.002	0.001	No
111	Dieldrin (303d listed)	0.00014	CTR, hh	0.002	0.002	No
112	alpha-Endosulfan	0.0087	CTR, hh	0.002	0.002	No
113	beta-Endosulfan	0.0087	CTR, hh	0.002	0.001	No
114	Endosulfan Sulfate	240	CTR, hh	0.002	0.001	No
115	Endrin	0.0023	CTR, hh	0.002	0.002	No
116	Endrin Aldehyde	0.81	CTR, hh	0.002	0.002	No
117	Heptachlor	0.00021	CTR, hh	0.003	0.003	No
118	Heptachlor Epoxide	0.00011	CTR, hh	0.002	0.002	No
119-125	PCBs sum (2)	0.00017	CTR, hh	0.07	0.34	No
126	Toxaphene	0.00020	CTR, hh	0.15	0.2	No
	Tributyltin	0.072	BP, fw	0.00048	0.00139	No

Footnotes for Tables F-7 and F-8:

[1] RPA based on the following: BP = Basin Plan; CTR = California Toxics Rule; NTR=National Toxics Rule; fw = freshwater; sw = saltwater; hh= human health; H= ambient hardness value.

[2] Values for MEC or maximum background in **bold** are the actual detected concentrations, otherwise the values shown are the minimum detection levels.
NA = Not Available (there is no monitoring data or WQO/WQC for this constituent).

[3] RP =Yes, if either MEC > WQO/WQC, or background > WQO/WQC when pollutant is detected in the effluent.
RP = No, if both MEC or background < WQO/WQC or all effluent concentrations non-detect and background <WQO/WQC or no background available.
RP = Uo (undetermined because no objective promulgated).
RP = Ud (undetermined due to lack of effluent data).

(3) *RPA Results for Impairing Pollutants.* While TMDLs and WLAs are being developed, interim concentration limitations are established in this permit for 303(d)-listed pollutants that have a reasonable potential to cause or contribute to an excursion above the water quality standard. In addition, mass limitations are

required for bioaccumulative 303(d)-listed pollutants that can be reliably detected. Constituents on the 303(d) list for which the RPA determined a need for effluent limitations is mercury. Final determination of reasonable potential for some other constituents identified on the 303(d) list could not be performed owing to the lack of an established WQO/WQC.

d. RPA Considerations for Specific Pollutants

- (1) **Copper.** This Order establishes effluent limitations for copper because the 9 µg/L (Outfall 001) and 8.8 µg/L (Outfall 002) MECs exceed the governing WQO of 6.5 µg/L, demonstrating reasonable potential by Trigger 1. This governing WQO is based on Basin Plan fresh water chronic objective for the protection of aquatic life.
- (2) **Mercury.** Using Trigger 3 as defined in IV.C.3.b, this Order establishes effluent limitations for mercury because San Pablo Bay is listed as impaired by mercury. Effluent limitations are necessary to limit the mercury loading into the Bay.
- (3) **Cyanide.** This Order establishes effluent limitations for cyanide because the 6 µg/L (Outfall 001) and 9.2 µg/L (Outfall 002) MECs exceed the governing WQC of 5.2 µg/L, demonstrating reasonable potential by Trigger 1. This governing WQC is based on NTR fresh water chronic objective for the protection of aquatic life.
- (4) **Chlorodibromomethane.** This Order establishes effluent limitations for chlorodibromomethane because the 4.5 µg/L (Outfall 001) and 11 µg/L (Outfall 002) MECs exceed the governing WQC of 0.41 µg/L, demonstrating reasonable potential by Trigger 1. This governing WQC is based on CTR criteria for the protection of human health (water and organisms).
- (5) **Dichlorobromomethane.** This Order establishes effluent limitations for dichlorobromomethane because the 13 µg/L (Outfall 001) and 22 µg/L (Outfall 002) MECs exceed the governing WQC of 0.56 µg/L, demonstrating reasonable potential by Trigger 1. This governing WQC is based on CTR criteria for the protection of human health (water and organisms).
- (6) **Dioxins and Furans.**
 - a) **Dioxin WQC.** The CTR establishes a numeric human health WQC of 0.014 picogram per liter (pg/L) for 2,3,7,8-tetrachlorinated dibenzo-p-dioxin (2,3,7,8-TCDD) based on consumption of aquatic organisms. The preamble of the CTR states that California NPDES permits should use toxicity equivalents (TEQs) where dioxin-like compounds have a reasonable potential with respect to narrative criteria. In USEPA's National Recommended WQOs, December 2002, USEPA published the 1998 World Health Organization Toxicity Equivalence

Factor (TEF)¹ scheme. In addition, the CTR preamble states USEPA’s intent to adopt revised WQC guidance subsequent to their health reassessment for dioxin-like compounds. The SIP applies to all toxic pollutants, including dioxins and furans. Staff used TEQs to translate the narrative WQOs to numeric WQOs for the other 16 congeners.

- b. The Basin Plan contains a narrative WQO for bioaccumulative substances:

“Many pollutants can accumulate on particulates, in sediments, or bioaccumulate in fish and other aquatic organisms. Controllable water quality factors shall not cause a detrimental increase in concentrations of toxic substances found in bottom sediments or aquatic life. Effects on aquatic organisms, wildlife, and human health will be considered.”

This narrative WQO applies to dioxin and furan compounds, based in part on the consensus of the scientific community that these compounds associate with particulates, accumulate in sediments, and bioaccumulate in the fatty tissue of fish and other organisms.

- c. USEPA’s 303(d) listing determined that the narrative objective for bioaccumulative pollutants was not met because of the levels of dioxins and furans in the fish tissue.
- d. *RPA Results*. There is no reasonable potential either triggered by the effluent or the receiving water concentration. But continued monitoring is required under this Order.

(7) ***Effluent Monitoring***. This Order does not include effluent limitations for constituents that do not show reasonable potential, but continued monitoring for these pollutants is required as described in Provision VII.C.2.a. If concentrations of these constituents increase significantly, the Discharger will be required to investigate the source of the increases and establish remedial measures if the increases result in a reasonable potential to cause or contribute to an excursion above the applicable WQO/WQC.

6. Whole Effluent Acute Toxicity

- a. *Permit Requirements*. This Order includes effluent limits for whole-effluent acute toxicity that are unchanged from the previous Order. All bioassays shall be performed according to the U.S. EPA approved method in 40 CFR 136, currently “Methods for Measuring the Acute Toxicity of Effluents and Receiving Waters to Freshwater and

¹ The 1998 WHO scheme includes TEFs for dioxin-like PCBs. Since dioxin-like PCBs are already included within “Total PCBs,” for which the CTR has established a specific standard, dioxin-like PCBs are not included in this Order’s version of the TEF scheme.

Marine Organisms, 5th Edition.” The Discharger is required to use the 5th Edition method for compliance determination upon the effective date of this Order.

- b. *Compliance History.* The Discharger’s acute toxicity monitoring data show that there were no exceedances of the acute toxicity effluent limitations during 2003-2005, with fish survival rates ranging between 80-100% for three-spined stickleback, and 95-100% for fathead minnows.
- c. *Ammonia Toxicity.* If acute toxicity is observed in the future and the Discharger believes that it is due to ammonia toxicity, this has to be shown through a Toxicity Identification Evaluation (TIE) acceptable to the Executive Officer. If the Discharger demonstrates to the satisfaction of the Executive Officer that exceedance of the acute toxicity limits is caused by ammonia and that the ammonia in the discharge is not adversely impacting receiving water quality or beneficial uses, then such toxicity does not constitute a violation of this effluent limit. If ammonia toxicity is verified in the TIE, the Discharger may utilize an adjustment protocol approved by the Executive Officer for the routine bioassay testing.

7. Whole Effluent Chronic Toxicity

- a. *Permit Requirements.* This permit includes requirements for chronic toxicity monitoring based on the Basin Plan narrative toxicity objective, and in accordance with U.S. EPA and State Water Board Task Force guidance, and BPJ. This permit includes the Basin Plan narrative toxicity objective as the applicable effluent limit, implemented via monitoring with numeric values as “triggers” to initiate accelerated monitoring and to initiate a chronic toxicity reduction evaluation (TRE) as necessary. The permit requirements for chronic toxicity are also consistent with the CTR and SIP requirements.
- b. *Chronic Toxicity Triggers.* This Order includes a chronic toxicity trigger, which is single sample maximum of 10 TUc. The trigger is revised from the previous permit, to be consistent with Basin Plan Table 4-6 for an annual sampling frequency. For the next permit reissuance, if a different dilution credit is demonstrated by the Discharger, the Regional Water Board may revise the trigger value based on the information.
- c. *Screening Phase Study.* The Discharger has performed a chronic toxicity screening phase study and the results of this study have been incorporated herein.
- d. *Permit Reopener.* The Regional Water Board will consider amending this permit to include numeric toxicity limits if the Discharger fails to aggressively implement all reasonable control measures included in its approved TRE workplan, following detection of consistent significant non-artifactual toxicity.

D. Final Effluent Limitations

1. Toxic substances are regulated by WQBELs derived from the Basin Plan (Tables 3-3 and 3-4), the CTR, the NTR, and/or BPJ. WQBELs in this Order are revised and updated from the limitations in the previous Order, and their presence in this Order is based on the evaluation of the Discharger's data as described above under the Reasonable Potential Analysis. Numeric WQBELs are required for all constituents that have a reasonable potential to cause or contribute to an excursion above any State water quality standard. Reasonable potential is determined and final WQBELs are developed using the methodology outlined in the SIP. If the Discharger demonstrates that the final limitations will be infeasible to meet and provides justification for a compliance schedule, then interim limitations are established with a compliance schedule to achieve the final limits.
2. **Summary of Final Effluent Limitations:**

Table F-9 below lists the WQBELs for the toxic pollutants that the Regional Water Board determines to have reasonable potential. The WQBELs calculation is attached as **Appendix F-8** of this Fact Sheet.

Table F-9. Summary of Water Quality-based Effluent Limitations for Discharge Points 001 and 002 [1][2]

Parameter	Units	Final Effluent Limitations	
		AMEL	MDEL
Copper	µg/L	5.7	9.6
Mercury	µg/L	0.020	0.042
Cyanide	µg/L	4.1	9.1
Chlorodibromomethane	µg/L	0.41	0.82
Dichlorobromomethane	µg/L	0.56	1.1

Footnote for Table F-9:

[1] Final effluent limitations for copper, chlorodibromomethane, and dichlorobromomethane will become effective on May 18, 2010, and those for cyanide will become effective on April 28, 2010, unless the Regional Water Board amends the effluent limitations based on SSOs and/or additional information.

3. Calculation of Final WQBELs

a. Copper

- 1) *Copper WQOs.* The applicable fresh water WQOs for copper in the Basin Plan are 6.5 µg/L for chronic protection and 9.2 µg/L for acute protection, based on a hardness value of 65 mg/L as CaCO₃, and converted to total recoverable metal using CTR conversion factor of 0.96. These objectives were used to determine reasonable potential and calculate effluent limitations.

- 2) *WQBELs*. The copper WQBELs calculated according to SIP procedures are 9.6 µg/L as the MDEL and 5.7 µg/L as the AMEL with zero dilution.
- 3) *Discharger's Performance and Attainability*. In a finding under interim effluent limitations, the Discharger cannot comply with the final WQBELs based on zero dilution. Therefore, an interim effluent limit was calculated (see more discussion in Section E.2 below).
- 4) *Antibacksliding/Antidegradation*. There is no final WQBEL in the previous permit, so there is no antibacksliding.. Antidegradation is also satisfied, as the new limits will prevent degradation of the water quality in the receiving water.

b. Mercury

- 1) *Mercury WQOs/WQC*. Both the Basin Plan and the CTR include objectives and criteria that govern mercury in the receiving water. The Basin Plan specifies objectives for the protection of fresh water aquatic life of 0.025 µg/L as a 4-day average and 2.4 µg/L as a 1-hour average. The CTR specifies a long-term average criterion for protection of human health of 0.050 µg/L for the consumption of water and organisms.
- 2) *Mercury WQBELs*. The mercury WQBELs calculated according to SIP procedures are 0.042 µg/L as the MDEL and 0.020 µg/L as the AMEL. No dilution credit is allowed in the calculation as mercury is a bioaccumulative pollutant.
- 3) *Discharger's Performance and Attainability*. During the period from November 2003 through January 2006, the Discharger's effluent mercury concentrations ranged from 0.0008 to 0.0074 µg/L (27 samples) for both Outfalls 001 and 002. A statistical analysis on the pooled data shows that the Discharge can comply with the effluent limits for mercury.
- 4) *Mercury TMDL*. The current 303(d) list includes San Pablo Bay as impaired by mercury, due to high mercury concentrations in the tissue of fish from the Bay. Methyl-mercury, the highly toxic form of mercury, is a persistent bioaccumulative pollutant. There is no evidence to show that the mercury discharged is taken out of the hydrologic system, by processes such as evaporation before reaching San Pablo Bay. Absent this evidence, the Regional Water Board assumes that the mercury reaches the Bay through either sediment transport or water flows. The Regional Water Board intends to establish a TMDL that will lead towards overall reduction of mercury mass loadings into San Pablo Bay. The final mercury effluent limitations will be based on the Discharger's WLA in the TMDL. While the TMDL is being developed, the Discharger will comply with mercury concentration and mass-based limitations to cooperate in maintaining current ambient receiving water conditions.

- 5) *Mercury Source Control Strategy.* The Regional Water Board is developing a TMDL to control mercury levels in San Pablo Bay. The Regional Water Board, together with other stakeholders, will cooperatively develop source control strategies as part of the TMDL development. Municipal discharge point sources are not a significant source of mercury to San Pablo Bay. Therefore, the currently preferred strategy is to apply interim mass loading limits to point source discharges while focusing mass reduction efforts on other more significant and controllable sources. While the TMDL is being developed, the Discharger will cooperate in maintaining ambient receiving water conditions by complying with performance-based mercury mass emission limits. Therefore, this Order includes interim mass loading effluent limitation for mercury, as described in Section E.4 below. The Discharger is required to implement source control measures and cooperatively participate in special studies, such as TMDL study, required by the Regional Water Board.
- 6) *Final Mercury Limitations.* Final mercury limitations will be revised/established to be consistent with the WLA assigned in the final mercury TMDL. While the TMDL is being developed, the Discharger will comply with performance-based mercury concentration and mass-based limitations to cooperate in maintaining current ambient receiving water conditions.
- 7) *Antibacksliding/Antidegradation.* There is no mercury WQBEL in the previous permit; therefore, there is no antibacksliding. Antidegradation is also satisfied as the new limits will prevent the degradation of the water quality in the receiving water.

c. Cyanide

- 1) *Cyanide WQC.* The NTR specifies cyanide WQC for the protection of aquatic life in fresh surface water, which are 5.2 µg/L for chronic protection, and 22 µg/L for acute protection. The NTR also specifies a long-term average criterion for protection of human health of 700 µg/L for the consumption of water and organisms.
- 2) *Cyanide WQBELs.* The cyanide WQBELs calculated according to SIP procedures are 9.1 µg/L MDEL and 4.1 µg/L AMEL based on zero dilution.
- 3) *Discharger's Performance and Attainability.* In a finding under interim effluent limitations, the Discharger cannot comply with the final WQBELs based on zero dilution. Therefore, an interim effluent limit was calculated (see more discussion in Section E.2 below).
- 4) *Anti-backsliding/Anti-degradation.* There is no cyanide final effluent limit in the previous permit, so there is no antibacksliding. With regard to antidegradation, the revised permit is consistent with antidegradation through pollutant minimization

requirements that will hold the Discharger to current performance. Any possible change in cyanide discharges would be relatively small and have no discernable effect on the receiving water.

d. Chlorodibromomethane and Dichlorobromomethane

- 1) *WQC*. In the CTR, the lowest criteria for chlorodibromomethane and dichlorobromomethane are the human health values of 0.41 and 0.56 µg/L, respectively, for the consumption of water and organisms.
- 2) *WQBELs*. The chlorodibromomethane WQBELs calculated according to SIP procedures are 0.82 µg/L MDEL and 0.41 µg/L AMEL based on zero dilution. The dichlorobromomethane WQBELs calculated according to SIP procedures are 1.1 µg/L MDEL and 0.56 µg/L AMEL based on zero dilution.
- 3) *Discharger's Performance and Attainability*. In a finding under interim effluent limitations, the Discharger cannot comply with the final WQBELs based on zero dilution for either pollutant. Therefore, interim effluent limits were calculated (see more discussion in Section E.2 below).
- 4) *Antibacksliding/Antidegradation*. There are no WQBELs in the previous permit for either pollutants; therefore, there is no antibacksliding. Antidegradation is also satisfied as the new limits will prevent the degradation of the water quality in the receiving water.

E. Interim Effluent Limitations

1. Interim Limitations and Compliance Schedules

- a. Section 2.1.1 of the SIP states:

“the compliance schedule provisions for the development and adoption of a TMDL only apply when: ... (b) the Discharger has made appropriate commitments to support and expedite the development of the TMDL. In determining appropriate commitments, the RWQCB should consider the discharge's contribution to current loadings and the Discharger's ability to participate in TMDL development.”

The Discharger has agreed to assist the Regional Water Board in TMDL development through active participation in and contribution to the Clean Estuary Partnership through the Bay Area Clean Water Agencies (BACWA). The Regional Water Board adopted Resolution No. 01-103 on September 19, 2001, authorizing the Executive Officer of the Regional Water Board to enter into a Memorandum of Understanding with BACWA and other parties to accelerate the development of Water Quality Attainment Strategies (WQAS), including TMDLs, for the San Francisco Bay-Delta and its tributaries.

- b. Compliance schedules are established based on Section 2.2 of the SIP for limitations derived from CTR or NTR WQC or based on the Basin Plan for limits derived from Basin Plan WQOs. In addition, the Regional Water Board has reasonably construed the Basin Plan provision to authorize compliance schedules for new interpretations of existing standards resulting in more stringent effluent limitations. If an existing discharger cannot immediately comply with a new and more stringent effluent limitation, the SIP and the Basin Plan authorize a compliance schedule in the permit. To qualify for a compliance schedule, both the SIP and the Basin Plan require that the discharger demonstrate that it is infeasible to achieve immediate compliance with the new limit. The SIP and Basin Plan require that the following information be submitted to the Board to support a finding of infeasibility:
- Descriptions of diligent efforts the discharger has made to quantify pollutant levels in the discharge, sources of the pollutant in the waste stream, and the results of those efforts.
 - Descriptions of source control and/or pollution minimization efforts currently under way or completed.
 - Proposed schedule for additional or future source control measures, pollutant minimization, or waste treatment.
 - Demonstration that the proposed schedule is as short as practicable.
- c. Until final WQBELs or WLAs are adopted for 303(d)-listed pollutants, State and Federal anti-backsliding and antidegradation policies and the SIP require that the Regional Water Board include interim effluent limitations for them. The interim effluent limitations will be the lower of the current performance or the previous permit's limitations, unless anti-backsliding and antidegradation requirements are met.
- d. Interim effluent limitations were derived for those constituents (copper, cyanide, chlorodibromomethane and dichlorobromomethane) for which the Discharger has shown infeasibility of complying with the respective final limitations and has demonstrated that compliance schedules are justified based on the Discharger's source control and pollution minimization efforts in the past and continued efforts in the present and future. The interim effluent concentration limitations are based on statistical analysis of the effluent data. The interim limitations are discussed in more detail below.
- e. This Order establishes a compliance schedule until May 17, 2010 for copper, chlorodibromomethane, and dichlorobromomethane, and April 27, 2010 for cyanide, as allowed by the CTR and Basin Plan, respectively. The final WQBELs for copper, chlorodibromomethane, and dichlorobromomethane will become effective on May 18, 2010, and those for cyanide will become effective on April 28, 2010. Since the

compliance schedules extend beyond 1 year, pursuant to the SIP and 40 CFR §122.47, the Regional Water Board must establish interim numeric limitations and interim requirements to control the pollutants. This Order establishes interim limits for copper, cyanide, chlorodibromomethane, and dichlorobromomethane, based on the previous permit limits or existing plant performance, whichever is more stringent, unless antibacksliding and antidegradation requirements are satisfied, to maintain existing water quality. **Appendix F-9** of the Fact Sheet details the general basis for final compliance dates. The Regional Water Board may take appropriate enforcement actions if interim limitations and requirements are not met.

2. Infeasibility Evaluation and Interim Effluent Limitations

- a. The Discharger submitted an infeasibility analysis on June 6, 2006 for copper, cyanide, chlorodibromomethane, and dichlorobromomethane (**Appendix F-11**). Regional Water Board staff performed statistical analysis using self-monitoring data from November 2003 through January 2006 to compare the mean, 95th percentile, and 99th percentile with the long-term average (LTA), AMEL, and MDEL (with zero dilution), respectively, to confirm if it is feasible for the Discharger to comply with WQBELs. If any of the LTA, AMEL, or MDEL exceeds the mean, 95th percentile, or 99th percentile, respectively, the infeasibility for the Discharger to comply with WQBELs is confirmed statistically. If infeasibility is confirmed, the 99.87th percentile (or mean plus three standard deviations) of the recent performance data or previous permit limit, whichever is more stringent, unless antibacksliding/antidegradation requirements are satisfied, is established as the interim limit. When the statistical analysis is not meaningful due to lack of appropriate distribution fit, a direct comparison of MEC and the AMEL is made; if infeasibility is confirmed, the MEC or the previous permit limit is set as the interim limit. Table F-10 shows these comparisons in µg/L:

Table F-10. Summary of Feasibility Analysis and Interim Limitations (unit: µg/L)

	<u>Mean vs. LTA</u>	<u>95th vs. AMEL</u>	<u>99th vs. MDEL</u>	<u>Feasible to Comply</u>	<u>Interim Limits</u>
Copper	4.6>4.1	8.4>5.7	11.1 >9.6	No	14.7
Mercury	0.0029<0.012	0.0073<0.020	0.012<0.042	Yes	--
Cyanide	2.9>2.4	8.0>4.1	13.1>9.1	No	21.6
Chlorodibromo-methane	--	6.1>0.41	7.6>0.82	No	9.6
Dichlorobromo-methane	--	16>0.56	19>1.1	No	23

- b. Specific bases for these interim limits are described in the following findings for these pollutants.
 - 1) Copper – An interim effluent limitation is required for copper since the Discharger has demonstrated and the Regional Water Board staff verified that the final effluent limitations calculated according to the SIP (with zero dilution) will be infeasible to

meet. Regional Water Board staff calculated an interim performance-based limitation (IPBL) of 14.7 µg/L (3 standard deviations above the mean), which is more stringent than the previous permit's effluent limitation of 18.3 µg/L. This interim limit is expressed as a daily maximum, and will remain in effect until May 17, 2010, or until the Regional Water Board amends the limitation based on new information or additional data. A maximum compliance schedule is given to allow the Discharger to perform a special study for alternate copper WQBELs.

- 2) Cyanide – An interim effluent limitation is required for cyanide since the Discharger has demonstrated and the Regional Water Board staff verified that the final effluent limitations calculated according to the SIP (with zero dilution) will be infeasible to meet. Regional Water Board staff calculated an IPBL of 21.6 µg/L (3 standard deviations above the mean), which is less stringent than the previous permit interim limit of 8.2 µg/L. However, the Discharger has asserted and Regional Water Board staff concurred that it is infeasible for the Discharger to achieve immediate compliance with the previous permit effluent limit. Therefore, a limit of 21.6 µg/L is established as the interim limit, expressed as a daily maximum. The establishment of a less stringent performance-based effluent limit is allowed by CWA Section 404(o)(2)(C) and (E). This interim limit will remain in effect until April 27, 2010, or until the Regional Water Board amends the limitation based on additional data. A maximum compliance schedule is given to allow the Discharger to perform a special study for alternate cyanide WQBELs.
 - 3) Chlorodibromomethane and Dichlorobromomethane – An interim effluent limitation is required for chlorodibromomethane and dichlorobromomethane since the Discharger has demonstrated and the Regional Water Board staff verified that the final effluent limitations calculated according to the SIP (with zero dilution) will be infeasible to meet. Regional Water Board staff calculated an IPBL of 9.6 µg/L (3 standard deviations above the mean) for chlorodibromomethane, and 23 µg/L for dichlorobromomethane, expressed as a daily maximum. These interim limits will remain in effect until May 17, 2010, or until the Regional Water Board amends the limitation based on additional data. A maximum compliance schedule is given to allow the Discharger to perform a special study for alternate WQBELs.
- b. *Antibacksliding/Antidegradation.* Antibacksliding does not apply to interim effluent limits so long as there is compliance with antidegradation requirements. The interim limits in this permit are in compliance with antidegradation requirements, because they are based on current Facility performance and will limit the discharge to the existing treatment level. Even if antibacksliding applies to interim limits, the interim limit for cyanide in this permit are exempt pursuant to CWA 402(o)(2)(C) and (E).

c. Attainability of Interim Performance-Based Limitations

1) Copper

During the period of November 2003 through January 2006, the Discharger's effluent concentrations for copper ranged from 1.7 µg/L to 9 µg/L (27 samples) for the pooled data from both Outfalls 001 and 002. All 27 samples were below the interim limitation of 14.7 µg/L. It is therefore expected that the Discharger can comply with the interim limitation for copper.

2) Cyanide

During the period of November 2003 through January 2006, the Discharger's effluent concentrations for cyanide ranged from 0.8 µg/L to 9.2 µg/L (27 samples) for the pooled data from both Outfalls 001 and 002. All 27 samples were below the interim limitation of 21.6 µg/L. It is therefore expected that the Discharger can comply with the interim limitation for cyanide.

3) Chlorodibromomethane and Dichlorobromomethane

During the period of November 2003 through January 2006, the Discharger's effluent concentrations for chlorodibromomethane ranged from 2.1 µg/L to 4.9 µg/L (6 samples) for the pooled data from both Outfalls 001 and 002, and for dichlorobromomethane ranged from 6.5 µg/L to 13 µg/L (6 samples). All samples were below the respective interim limitations of 9.6 and 23 µg/L. It is therefore expected that the Discharger can comply with the interim limitations for chlorodibromomethane and dichlorobromomethane.

4. Mercury Interim Mass Emission Limitation/Mass Trigger

This Order includes an interim mercury mass-based effluent limitation of 0.73 grams per month (g/mo) and a mass trigger of 0.33 g/mo. Both the mass limit and mass trigger were calculated using the ultra-clean data collected from November 2003 through December 2005 (See **Appendix F-10** for the mercury mass limit and trigger calculation). The mass limit will maintain current loadings until a TMDL is established for San Pablo Bay. The final mercury effluent limitations will be based on the Discharger's WLA in the TMDL. If the mass trigger is exceeded, then the actions specified in Provision VII.C.3.b are required.

The inclusion of interim performance-based mass limits for bioaccumulative pollutants is consistent with the guidance described in section 2.1.1 of the SIP. Because of their bioaccumulative nature, an uncontrolled increase in the total mass load of these pollutants in the receiving water will have significant adverse impacts on the aquatic ecosystem.

The Regional Water Board includes a mass limit and trigger level for mercury in the permit to maintain ambient water quality. The combination of limit and trigger will protect the receiving water and will not cause further degradation of the water's beneficial uses. The mass trigger level in the permit requires the Discharger, when loading exceeds the trigger, to take certain specified actions to determine the cause of the higher load and to bring the mercury mass back below the trigger.

F. Comparison to Previous Permit Limitations

The effluent limitations for BOD, TSS, BOD and TSS removal, oil and grease, pH, turbidity, chlorine residual, and total coliform have been retained from the previous permit for Outfall 001, except for those daily maximum effluent limitations for BOD and TSS are no longer required, instead, weekly effluent limitations are interpolated between the previous maximum daily and monthly average limits. Settleable solids effluent limitations are no longer required. For Outfall 002, technology-based effluent limits are the same as those in the previous permit.

The interim effluent limit for cyanide is higher than the interim limit in the previous permit, and the relaxation is needed and is in compliance with the SIP and the antibacksliding/antidegradation requirements.

There was no effluent limitation for mercury in the previous permit.

The effluent limitations for lead, silver, zinc, and benzo(a) anthracene are no longer required as there is no reasonable potential based on performance data.

The effluent limitations for acute toxicity are unchanged from the previous Order. Chronic toxicity trigger value is modified to be consistent with Basin Plan requirement.

G. Reclamation Specifications

The Discharger's reclamation is now covered under the Regional Water Board's general reclamation permit Order No. 96-011. Therefore, the Discharger shall comply with all the requirements in Order 96-011 for its reclamation and land disposal activities.

V. RATIONALE FOR RECEIVING WATER LIMITATIONS

- A. Receiving Water Limitations V.A.1 and V.A.2. These limitations are in the existing permit except for dissolved oxygen (DO) and are based on water quality objectives for physical, chemical, and biological characteristics from Chapter III of the Basin Plan. The previous permit includes a wrong DO limitation for Napa River, which supports cold fish habitat.
- B. Receiving Water Limitation V.A.3: This limitation is in the existing permit, requires compliance with Federal and State law. It reserves the right of the Regional Water Board to reopen or modify this Order if necessary to implement more stringent water quality standards, if adopted.

VI. RATIONALE FOR MONITORING AND REPORTING REQUIREMENTS

The principal purposes of a monitoring program by a discharger are to:

- Document compliance with waste discharge requirements and prohibitions established by the Regional Water Board,
- Facilitate self-policing by the discharger in the prevention and abatement of pollution arising from waste discharge,
- Develop or assist in the development of limitations, discharge prohibitions, national standards of performance, pretreatment and toxicity standards, and other standards, and to
- Prepare water and wastewater quality inventories.

Section 122.48 of 40 CFR requires all NPDES permits to specify recording and reporting of monitoring results. Sections 13267 and 13383 of the California Water Code authorize the Water Boards to require technical and monitoring reports. The Monitoring and Reporting Program (**Attachment E**), establishes monitoring and reporting requirements to implement federal and state requirements. The following provides the rationale for the monitoring and reporting requirements contained in the Monitoring and Reporting Program for this Facility.

The Discharger is required to conduct monitoring of the permitted discharges in order to evaluate compliance with permit conditions. Monitoring requirements are contained the MRP (**Attachment E**) and Self-Monitoring Program, Part A (**Attachment G**). Part A of the monitoring program (**Attachment G**) is a standard requirement in almost all NPDES permits issued by the Regional Water Board. Most of the requirements are also existing requirements for the Discharger. Part A contains definitions, specifies general sampling and analytical protocols, and specifies reporting of spills, violations, and routine monitoring data in accordance with NPDES regulations, the California Water Code, and Regional Water Board policy. The MRP (**Attachment E**) of this Order is specific for the Discharger. It defines the stations, constituents, and frequency of monitoring, and additional reporting requirements. Constituents required to be monitored include all parameters for which effluent limitations are specified. This is to allow determination of compliance with permit limitations in accordance with 40 CFR §122.44(i). Monitoring for additional constituents, for which no effluent limitations are established, is also required to provide data for future RPAs.

A. Influent Monitoring

This MRP includes monitoring of the influent for the same parameters as those in the previous Order.

B. Effluent Monitoring

The MRP includes monitoring at the outfalls for conventional, non-conventional, and toxic pollutants, and acute and chronic toxicity. This Order requires monthly monitoring for copper, mercury, cyanide to demonstrate compliance with the effluent limits, and twice per year monitoring for chlorodibromomethane and dichlorobromomethane during discharge season.

For other metals, the Discharger is required to sample twice per year (during the discharge season), and for all other organic priority pollutants once during the permit term, according to the Regional Water Board's 13267 Letter dated August 6, 2001, and submit the results with its permit renewal application.

C. Whole Effluent Toxicity Testing Requirements

This Order requires monthly monitoring of the acute toxicity with either rainbow trout or fathead minnow, and annually monitoring for chronic toxicity with *ceriodaphnia dubia*, at both outfalls. When the chronic toxicity trigger is exceeded, the Discharger will accelerate monitoring to monthly. The requirements are unchanged from the previous permit (except for the testing species and accelerated monitoring frequency).

D. Receiving Water Monitoring

1. Regional Monitoring Program (RMP)

On April 15, 1992, the Regional Water Board adopted Resolution No. 92-043 directing the Executive Officer to implement the Regional Monitoring Program (RMP) for the San Francisco Bay. Subsequent to a public hearing and various meetings, Regional Water Board staff requested major permit holders in this region, under authority of section 13267 of California Water Code, to report on the water quality of the estuary. These permit holders responded to this request by participating in a collaborative effort, through the San Francisco Estuary Institute. This effort has come to be known as the San Francisco Bay Regional Monitoring Program for Trace Substances. This Order specifies that the Discharger shall continue to participate in the RMP, which involves collection of data on pollutants and toxicity in water, sediment and biota of the estuary.

2. Site-Specific Receiving Water Monitoring

This Order requires monthly monitoring of the Napa River for the same parameters as those contained in the previous permit, such as pH, temperature, dissolved oxygen, nutrients, chloride, TDS (or salinity), and hardness. Dissolved oxygen (DO) saturation is added to monitor the DO situation in the receiving water. In lieu of near field discharge specific ambient monitoring for priority pollutants, it is generally acceptable that the Discharger participate in collaborative receiving water monitoring with other dischargers under the provisions of the Board's August 6, 2001 letter and the Regional Monitoring Program (RMP).

VII. RATIONALE FOR PROVISIONS

A. Standard Provisions

Standard Provisions, which in accordance with 40 CFR §§122.41 and 122.42 apply to all NPDES discharges and must be included in every NPDES permit, are provided in **Attachment D**.

B. Monitoring and Reporting Requirements

The Discharger is required to conduct monitoring of the permitted discharges in order to evaluate compliance with permit conditions. Monitoring requirements are contained in the MRP (**Attachment E**) and Standard Provisions and SMP, Part A (**Attachment G**) of the Permit. This provision requires compliance with these documents, and is based on 40 CFR 122.63. The Standard Provisions and SMP, Part A are standard requirements in almost all NPDES permits issued by the Regional Water Board, including this Order. They contain definitions of terms, specify general sampling and analytical protocols, and set out requirements for reporting of spills, violations, and routine monitoring data in accordance with NPDES regulations, the California Water Code, and Regional Water Board's policies. The MRP contains a sampling program specific for the facility. It defines the sampling stations and frequency, the pollutants to be monitored, and additional reporting requirements. Pollutants to be monitored include all parameters for which effluent limitations are specified. Monitoring for additional constituents, for which no effluent limitations are established, is also required to provide data for future completion of RPAs for them.

C. Special Provisions

1. Reopener Provisions

These provisions are based on 40 CFR §123 and allow future modification of this Order and its effluent limitations as necessary in response to updated WQOs that may be established in the future.

2. Special Studies and Additional Monitoring Requirements

- a. Effluent Characterization Study. This Order does not include effluent limitations for the selected constituents addressed in the August 6, 2001 Letter that do not demonstrate Reasonable Potential, but this provision requires the Discharger to continue monitoring for these pollutants as described in the August 6, 2001 Letter and as specified in the MRP of this Order. If concentrations of these constituents increase significantly, the Discharger will be required to investigate the source of the increases and establish remedial measures, if the increases result in reasonable potential to cause or contribute to an excursion above the applicable WQO/WQC. This provision is based on the Basin Plan and the SIP 1.2 and 1.3. Furthermore, this information requirement is authorized by CWC section 13267 and 13383. Continued effluent characterization is necessary to track any change to the quality of the discharge to 1) ensure that the limitations in this Order are protective in that all parameters that warrant limits are limited, and 2) provide a basis for establishing effluent limitations and requirement in the next NPDES permit reissuance. The Discharger is clearly responsible for providing the information. The frequency of monitoring is not onerous, and is reasonable and affordable for the relative size of the Discharger.

- b. Ambient Background Receiving Water Study. This provision is based on the Basin Plan, the SIP, and the August 6, 2001 Letter for priority pollutant monitoring. This information requirement is authorized by CWC section 13267 and 13383. Continued ambient background monitoring is necessary to track any changes in the quality of the receiving water so as to provide an up-to-date basis for establishing effluent limitations and requirements in the next NPDES permit reissuance. The Discharger is clearly responsible for providing this information. The frequency of monitoring is not onerous, and is reasonable and affordable for the relative size of the Discharger, particularly since the Discharger has and will continue to participate in a cost sharing collaborative effort with other dischargers.
- c. Diffuser Feasibility Study. This provision is based on BPJ and SIP requirement on dilution determination.
- d. Mixing Zone and Dilution Credit Evaluation Study. This provision is based on SIP, Section 1.4.2.1, requiring the Discharger to perform studies to demonstrate dilution for incompletely mixed discharges.
- e. Secondary Discharge Performance and Effluent Limitation Study. This study requires the Discharger to monitor its secondary effluent for BOD and TSS, and compare those results with effluent limits for tertiary effluent. If significant exceedances of those limits are observed, the Discharger is required to evaluate whether the technology-based effluent limitations are protective of the beneficial uses of the receiving water, specifically, for steelhead spawning. Higher dissolved oxygen is required for fish spawning, and high TSS and BOD may cause low DO levels in the downstream receiving water. The discharges have been at low TSS and BOD levels in the past; however, if the Discharger wants to discharge at the permit effluent limits level, the protection of beneficial uses has to be demonstrated through this special study. More stringent effluent limits may be established if adverse impacts were to be projected.
- f. Optional Mass Offset: This Order contains requirements to prevent further degradation of impaired waterbodies. Such requirements include the adoption of interim mass limitations that are based on treatment plant performance, provisions for aggressive source control, feasibility studies for additional wastewater reclamation, and treatment plant optimization. After implementing these efforts, the Discharger may find that further net reductions of the total mass loadings of the 303(d)-listed pollutants to the receiving water can be achieved only through a mass offset program. This option is provided to encourage the Discharger to further implement aggressive reduction of mass loads to the San Pablo Bay.
- g. Status Report on 303(d)-Listed Pollutants, Site-Specific Objective and TMDL: This Order grants maximum compliance schedules based on the Basin Plan for copper, cyanide, dichlorobromomethane, and chlorodibromomethane because time is needed for the Discharger to perform a special study (diffuser or mixing zone) to determine

an appropriate dilution credit. The interim limits are granted also because of the Discharger's commitment to support TMDL and other region-wide efforts. It is appropriate for the Discharger to annually report on and track its efforts to support the TMDL and SSO. This report is authorized by SIP 2.2.1 and is necessary to comply with it. SIP 2.2.1 requires that the Regional Water Board establish interim requirements and dates, and that there be no more than one year between interim dates. Additionally, this requirement is authorized pursuant to CWC 13267 and 13383. The information required is minimal relative to the range of studies that could be required as a condition of being granted a compliance schedule. However, this minimal requirement is appropriate at this time because of ongoing region-wide efforts on TMDLs and SSOs supported by the Discharger that will result in appropriately protective objectives and allocations for the pollutants in question.

3. Best Management Practices and Pollution Prevention

- a. Pollutant Minimization Program: This provision is based on Chapter 4 of the Basin Plan and Section 2.4.5 of the SIP. Furthermore, for copper, cyanide, chlorodibromomethane, and dichlorobromomethane, implementation of pollution minimization is based on Section 2.2.1 of the SIP because compliance schedules are granted for these four pollutants. For copper and cyanide, the pollution prevention measures are to ensure compliance with antidegradation because the copper alternate WQBELs and cyanide interim limit/alternate WQBELs in this Order are numerically less stringent than in the previous Order.

Additionally, on October 15, 2003, the Regional Water Board adopted Resolution R2-2003-0096 in support of a collaborative working approach between the Regional Water Board and the Bay Area Clean Water Agencies to promote Pollution Minimization Program development and excellence. Specifically, the Resolution embodies a set of eleven guiding principles that will be used to develop tools such as "P2 menus" for specific pollutants, as well as provide guidance in improving P2 program efficiency and accountability. Key principles in the Resolution include promoting watershed, cross-program and cross-media approaches to pollution prevention, and jointly developing tools to assess program performance that may include peer reviews, self-audits or other formats.

- b. Mercury Mass Loading Reduction: This provision will help to ensure no increases in mercury mass loadings until a TMDL and WLA are established. The Regional Water Board's determination of the need to maintain mass loadings at current levels for this bioaccumulative pollutant are based on Section 2.1.1 of the SIP.

4. Compliance Schedules – Chlorodibromomethane and Dichlorobromomethane

This provision requires the Discharger to evaluate the source, fate of these two disinfection byproducts in the effluent, and to evaluate the measures to reduce their concentrations, to

bring full compliance with the final WQBELs. This provision is based on the SIP and 40 CFR §122.47 and the Basin Plan.

5. Construction, Operation, and Maintenance Specifications

- a. Wastewater Facilities, Review and Evaluation, Status Reports: This provision is based on the previous permit and the Basin Plan.
- b. Operations and Maintenance Manual, Review and Status Reports: This provision is based on the Basin Plan, the requirements of 40 CFR §122, and the previous permit.
- c. Contingency Plan, Review and Status Reports: This provision is based on the Basin Plan, the requirements of 40 CFR §122, and the previous permit.

6. Special Provisions for POTWs

- a. Sludge Management Practices Requirements: This provision is based on the Basin Plan (Chapter IV) and 40 CFR §§257 and 503.
- b. Sanitary Sewer Management Plan: This provision is to explain the Order's requirements as they relate to the Discharger's collection system, and to promote consistency with the State Water Resources Control Board adopted Statewide General Waste Discharge Requirements for Sanitary Sewer Overflow (SSO WDRs) and a related Monitoring and Reporting Program (Order No. 2006-0003-DWQ). The bases for these requirements are described elsewhere in this Fact Sheet for those requirements.

7. Other Special Studies

Emergency discharge procedure: This provision is based on BPJ.

VIII. PUBLIC PARTICIPATION

The Regional Water Board is considering the issuance of waste discharge requirements (WDRs) that will serve as an NPDES permit for the City of Calistoga. As a step in the WDR adoption process, the Regional Water Board staff developed tentative WDRs (draft permit). The Regional Water Board encourages public participation in the WDR adoption process.

A. Notification of Interested Parties

The Regional Water Board notified the Discharger and interested agencies and persons of its intent to prescribe waste discharge requirements for the discharge and provided them with an opportunity to submit their written comments and recommendations. Notification was provided through the following: (a) paper and electronic copies of this Order were relayed to the Discharger, and (b) the Napa Register published a notice that this item would appear before the Board on October 11, 2006.

B. Written Comments

Staff determinations are tentative. Interested persons are invited to submit written comments concerning the tentative WDRs (draft permit). Comments should be submitted either in person or by mail to the Executive Office at the Regional Water Board at the address above on the cover page of this Order.

To be fully responded to by staff and considered by the Regional Water Board, written comments should be received at the Regional Water Board offices by 5:00 p.m. on September 18, 2006.

C. Public Hearing

The Regional Water Board will hold a public hearing on the tentative WDRs during its regular Board meeting on the following date and time and at the following location:

Date: October 11, 2006
Time: 9:00 am
Location: Elihu Harris State Office Building
1515 Clay Street
Oakland, CA
1st floor Auditorium
Contact: Bill Johnson, Phone: (510) 622-2354; email: WJohnson@waterboards.ca.gov

Interested persons are invited to attend. At the public hearing, the Regional Water Board will hear testimony, if any, pertinent to the discharge, WDRs, and permit. Oral testimony will be heard; however, for accuracy of the record, important testimony should be in writing.

Please be aware that dates and venues may change. Our web address is www.waterboards.ca.gov/sanfranciscobay where you can access the current agenda for changes in dates and locations. Regional Water Board agenda package including staff's responses to written comments, and revised draft permit will be posted at this website no later than one week prior to the hearing date.

D. Waste Discharge Requirements Petitions

Any aggrieved person may petition the State Water Resources Control Board to review the decision of the Regional Water Board regarding the final WDRs. The petition must be submitted within 30 days of the Regional Water Board's action to the following address:

State Water Resources Control Board
Office of Chief Counsel
P.O. Box 100, 1001 I Street
Sacramento, CA 95812-0100

E. Information and Copying

The Report of Waste Discharge (ROWD), related documents, tentative effluent limitations and special provisions, comments received, and other information are on file and may be inspected at the address above at any time between 8:30 a.m. and 4:45 p.m. except from noon to 1:00 p.m., Monday through Friday. Copying of documents may be arranged through the Regional Water Board by calling (510) 622-2300.

F. Register of Interested Persons

Any person interested in being placed on the mailing list for information regarding the WDRs and NPDES permit should contact the Regional Water Board, reference this facility, and provide a name, address, and phone number.

G. Additional Information

Requests for additional information or questions regarding this tentative DWR (draft permit) should be directed to Bill Johnson at (510) 622-2354 or email WJohnson@waterboards.ca.gov.

IX. APPENDICES

Appendix F-1: City of Calistoga Dunaweal Wastewater Treatment Plant Facility Narrative

Appendix F-2: Discharger's Memo dated May 30, 2006

Appendix F-3: Receiving Water Hardness, Chloride, and TDS Monitoring Data

Appendix F-4: Applicable Water Quality Objectives/Water Quality Criteria

Appendix F-5: RPA Results for Priority Pollutants

Appendix F-6: Effluent Data for Priority Pollutants

Appendix F-7: Napa River Ambient Monitoring Data (Calistoga Station)

Appendix F-8: Calculation of Final WQBELs

Appendix F-9: General Basis for Final Compliance Dates

Appendix F-10: Mercury Mass Limit and Trigger Calculation

Appendix F-11: Discharger's Infeasibility Analysis

Fact Sheet Appendix F-1

**City of Calistoga
Dunaweal Wastewater Treatment Plant**

Facility Narrative

CITY OF CALISTOGA DUNAWEAL WASTEWATER TREATMENT PLANT FACILITY NARRATIVE

Influent Wastewater Characteristics

The City of Calistoga owns and operates the Dunaweal Wastewater Treatment Plant (WWTP), which provides tertiary level treatment for domestic, commercial, and some industrial wastewater from the City of Calistoga. The commercial entities are composed primarily of spas, hotels, and restaurants. The industrial generators are two mineral water bottling companies. The WWTP has an average dry weather design flow of 0.84 million gallons per day (mgd) and can treat up to 4.0 mgd during wet weather flow events.

Wastewater Treatment Plant Operation

The treatment process for recycled water consists of screening at the headworks, secondary treatment by aeration and clarification, tertiary treatment by coagulation and filtration, and disinfection. After secondary or tertiary treatment, the effluent may be discharged to the Napa River from October 1st through May 15th (NPDES Permit No. CA0037966). During the remainder of the year, the effluent is treated to tertiary standards, distributed for recycled water use, or stored for future use or disposal. The following sections include detailed descriptions of the treatment processes and the equipment:

Headworks

The headworks receive raw wastewater from the City of Calistoga collection system through an 18-inch diameter gravity main and may also receive return sludge from the sludge holding tank. Although the treatment plant is capable of treating a peak wet weather flow of 4 mgd, the headworks is designed for flows up to 7 mgd. If there are problems with the headworks system or the influent exceeds 4 mgd, flows are diverted to the flow equalization basin using a motor-controlled slide gate. If needed to control odors or pH, chlorine or caustic soda may be injected at this point.

The headworks consist of a self-cleaning Parkson Aquaguard mechanical bar screen, an emergency bar screen, and a Parshall flume flow meter. The design and operational criteria for the headworks are presented in **Table 1**. If the loading conditions exceed the design parameters for the aeration basins, flow from the headworks may be diverted to the flow equalization basin.

Table 1. Design and Operational Criteria for the Headworks

Design Criteria	Value
Maximum capacity	7 mgd
Rated capacity	4 mgd
Mechanical bar screen spacing	6 mm
Emergency bar screen spacing	1 in
Parshall flume throat	12 in

Primary Distribution Structure

The primary distribution structure receives flow from the headworks (up to 4 mgd), return activated sludge from the clarifiers, and waste flows from other processes when required. The distribution structure regulates flow into the aeration basins by means of a weir gate, a sludge gate, and an adjustable weir gate for each basin. A manually operated slide gate can be used to divert flows to the equalization basin.

Aeration Basins and Clarifiers

The aeration basins and clarifiers comprise a Parkson Biolac-R System, two aeration basins and four clarifiers. The aeration basins receive mixed liquor from the primary distribution structure. Aeration occurs from fine-bubble diffusers, suspended near the bottom of the aeration basins, which create a displacement of floating aeration chains. The slow, continuous oscillation created by the diffusers results in high-efficiency mixing. Under normal operations, the total plant flow is split evenly among the two aeration basins. The blowers are operated automatically based on either a specified duration or a specified dissolved oxygen range. The mixed liquor flows through the aeration basins and into the clarifiers.

Sludge removal in the clarifiers is accomplished by an air lift assembly, aided by a flocculating rake mechanism which travels back and forth across the length of the clarifier. Clarifier effluent is discharged through an overflow weir. The activated sludge is either returned to the primary distribution structure or wasted to the sludge holding tank and sludge drying beds. The design and operational criteria for the aeration basins and clarifiers are presented in **Tables 2 and 3**, respectively.

Table 2. Aeration Basin Design and Operational Criteria

Design Criteria	Value
Number of basins	2
Maximum flow (each)	2 mgd
Surface area (each)	12,100 ft ²
Basin volume (each)	0.73 mgal
Detention time @ ADWF (each)	0.87 days
Number of Blowers	3 (2 duty, 1 standby)
Air requirements	2,600 standard ft ³ /min

Table 3. Clarifier Design and Operational Criteria

Design Criteria	Value
Type	Integral-Rectangular
Number of modules	4
Surface area (each)	1,242 ft ²
Overflow rate @ ADWF (ea)	169 gpd/ft ²
Overflow rate @ PWWF (ea)	805 gpd/ft ²
Weir length (ea)	37 ft x 2 sides
Weir loading at PWWF (ea)	14,000 gpd/ft

Secondary Chlorine Contact Basin and Discharge Structure

Secondary disinfection is conducted only during the wet season when influent flows exceed the filter capacity. The secondary system is not used during the dry season when effluent is being treated to tertiary standards for recycling.

The secondary chlorine contact basin is a plug flow reactor that can receive up to 3 mgd of chlorinated secondary effluent. Sodium bisulfite is injected to the basin effluent to accomplish dechlorination prior to river discharge. The sodium bisulfite feed rate can be controlled either manually or automatically adjusted to the wastewater flowrate. Caustic soda may be injected at this point for pH control.

The secondary discharge structure receives the dechlorinated water from the secondary chlorine contact basin. From this location, secondary effluent is either discharged to the Napa River or diverted to the flow equalization basin for temporary storage prior to further treatment. In-line analyzers are operated to monitor chlorine residual and pH. If either one of these constituents are determined to be out of range, a motor-controlled slide gate opens and flow is diverted to the equalization basin. The design and operational criteria for the secondary chlorine contact basin are presented in **Table 4**.

Table 4. Secondary Chlorine Contact Basin Design and Operational Criteria

Design Criteria	Value
Volume	63,000 gal
Detention time @ 3 mgd	30 min

Filters

Two variable speed filter pumps are designed to pump up to 1 mgd of secondary effluent from the clarifiers to the filters. The speed of the pumps is automatically controlled by flow set points

in the computer system. Flow from the filter pumps shall not exceed 5 gpm/ft² of filter surface area pursuant to Section 60301.302, Title 22 of the California Code of Regulations (CCR).

Polymer is injected at the filter pumps and mixed with the effluent in order to achieve coagulation prior to filtration. The polymer feed pump is controlled by the flow detected by the flow meter. Chlorine can also be added at this location for periodic cleaning of the filter. The chlorine solution feed pumps are controlled manually from the local process controller.

Parkson DynaSand Filters, continuously backwashing sand filters, are used to achieve tertiary treatment. The filter effluent is continuously monitored for turbidity and flow is diverted to the primary distribution structure if turbidity limits are exceeded. Filter backwash water is also returned to the primary distribution structure. The filter effluent may also be diverted to the utility water clearwell, if necessary. The design and operational criteria for the filter pumps and the filters are presented in **Tables 5 and 6**, respectively.

Table 5. Filter Pump Design and Operational Criteria

Design Criteria	Value
Number of pumps	2 (1 duty, 1 standby)
Rated flow	700 gpm
Rated head	30 ft
Motor	7.5 hp, variable-speed

Table 6. Filter Design and Operational Criteria

Design Criteria	Value
Number of filters	3 (2 duty, 1 standby)
Filter area per module	78 ft ²
Design flow	1 mgd
Hydraulic loading rate (1 mgd/2 filters)	4.4 gpm/ft ²
Hydraulic loading rate (1 mgd/3 filters)	3.0 gpm/ft ²
Expected Influent Turbidity	4 - 6.5 NTU
Expected Effluent Turbidity	0.25 to 0.6 NTU
Air requirements @ 30 psig	1 – 4 SCFM/ea
Reject rate	5-10%

Tertiary Chlorine Contact Basin

The tertiary chlorine contact basin receives up to 1 mgd of filter effluent. Effluent from the filters is injected with chlorine solution and mechanically mixed in the filter valve vault. The chlorine residual is continuously monitored and if it is too low, a motor-controlled valve will

open to divert flows to the flow equalization basin. During the dry season, the chlorinated effluent flows to the Utility Water Clearwell and the Irrigation Pump Station. During the wet season, the disinfected effluent is diverted to the Riverside Ponds prior to river discharge. Design and operational criteria for the tertiary chlorine contact basin are presented in **Table 7**.

Table 7. Tertiary Chlorine Contact Basin Design and Operational Criteria

Design Criteria	Value
Volume	83,500 gal
Side water depth	11.6 ft
Detention time @ PDWF	2 hr

Riverside Ponds

During the wet season, the disinfected tertiary effluent is diverted to the Riverside Ponds prior to river discharge. En route to the ponds, the effluent is injected with sodium bisulfite for dechlorination and caustic soda for pH adjustment (if needed). In-line analyzers are installed after the injection points. If a chlorine residual is detected or the flow is outside the desired pH range, effluent is diverted from the Utility Water Clearwell to the Effluent Storage Pond. This set of controls prevents discharge violations to the Napa River. The Riverside Ponds consist of four ponds that can be operated in series or parallel. Total pond area is 2.7 acres.

Utility Water Clearwell

The Utility Water Clearwell receives disinfected effluent from the tertiary chlorine contact basin. The effluent is stored at the clearwell for recycled water use by the plant’s utility water system. Utility water is used onsite for hosing down equipment and as the supply water for the clarifier spray system. The total volume available in the utility water clearwell is 21,000 gallons. Utility water not used onsite for maintenance activities, overflows from the clearwell to either the Effluent Storage Pond, the Irrigation Pump Station, or the Riverside Ponds.

Flow Equalization Basin

The flow equalization basin is a storage basin used to hold auxiliary/emergency flows from various plant processes. The flow equalization basin may receive raw wastewater from the headworks overflow, mixed liquor from the primary distribution structure, scum from the clarifiers, secondary effluent from the secondary disinfection pump wet well, non-potable water from the secondary discharge structure, tertiary treated water from the tertiary chlorine contact basin, emergency overflow from the effluent storage pond, or drainage from the sludge drying beds. Total volume available in the basin is 5.6 mgal.

Wastewater from the flow equalization basin flows to the aeration/clarification system via pumps in the equalization wet well. There are two submersible pumps in the wet well. The pumps do not operate unless the influent headworks flow is less than 3.5 mgd. The design and operational criteria for the equalization pumps are presented in **Table 8**.

Table 8. Equalization Pump Design and Operational Criteria

Design Criteria	Value
Number of pumps	2 (1 duty, 1 standby)
Rated flow	350 gpm
Rated head	19 ft
Motor	3 hp

Effluent Storage Pond

The effluent storage pond is a storage basin used to hold tertiary-treated effluent before it is recycled or discharged from the plant. Total volume available in the storage pond is 20 mgal. Flow from the effluent storage pond occurs via two submersible effluent pumps in the effluent pump wet well. From the wet well, the tertiary effluent is pumped to either the irrigation pump station for recycled water use or to the Riverside Ponds for river discharge. The design and operational criteria for the effluent pumps are presented in **Table 9**.

Table 9. Effluent Pump Design and Operational Criteria

Design Criteria	Value
Number of pumps	2 (1 duty, 1 standby)
Rated flow	700 gpm
Rated head	47 ft
Motor	15 hp

Sludge Holding Tank/Sludge Drying Beds

Sludge is collected in the clarifiers and wasted periodically to maintain an optimal bacteria population. Discharge of solids may occur continuously or at scheduled intervals. The Return Activated Sludge (RAS) is returned to the primary distribution structure and the Waste Activation Sludge (WAS) is sent to the sludge holding tank. The volume available in the sludge holding tank is 72,000 gallons. Supernatant from the sludge holding tank is sent to the primary distribution structure. From the sludge holding tank, sludge is either pumped to the sludge drying beds or trucked off-site for further treatment. Final sludge disposal occurs by dump truck pickup from the sludge holding area.

Drainage from the sludge drying beds is sent to the equalization pump wet well. The design and operational criteria for the sludge pumps and drying beds are presented in **Tables 10 and 11**, respectively.

Table 10. Sludge Pump Design and Operational Criteria

Design Criteria	Value
Number of pumps	1
Type	Progressing cavity pump
Motor	5 hp, 1160 rpm

Table 11. Sludge Drying Bed Design and Operational Criteria

Design Criteria	Value
Number	3
Influent flow, maximum	12,000 gpd
Bed size (each)	800 ft ²
Loading rate @ maximum influent flow	5 gpd/ft ²

Fact Sheet Appendix F-2

Discharger's Memo

Dated May 30, 2006

Memorandum

Date: May 30, 2006

To: Tong Yin, San Francisco Bay Regional Water Quality Control Board

From: Denise Conners, Larry Walker Associates
(on behalf of the City of Calistoga)

Subject: Calistoga NPDES Permit Renewal Issues (Permit No. CA 0037966)

The City of Calistoga would like to address the following permit issues in a meeting scheduled with the Water Board on Wednesday, May 31st (1:30pm). We are summarizing the issues and proposed solutions in this memo to facilitate the meeting process.

Reasonable Potential Analysis (RPA) and Proposed Effluent Limits

(1) Calculation of Cyanide Limits

The number of samples per month used by the Water Board to calculate the final effluent limits was $n = 22$. Calistoga only collects 1 sample/month for cyanide analysis. Per SIP guidelines, the number of samples per month to be used in the RPA calculations should be a maximum of $n=4$.

Recommendation:

Use $n=4$ for the calculation of effluent limits in the Tentative Order.

(2) Copper Limits

It is inappropriate to prescribe a more stringent interim limit for copper when the City can easily meet its final limits. However, expected adoption of the copper Site Specific Objective (SSO) will result in new methods of calculating copper limits. In fact, recent draft permits have included "alternative copper limits" based on the imminent SSO adoption. The City requests that the Water Board use SIP-prescribed limits until the SSO is adopted. The alternative copper limits should also be included in the new permit, so these limits will be automatically mandated when the SSO is adopted.

Recommendation:

Use SIP-prescribed limits for copper in the Tentative Order until the copper SSO is adopted.

(3) Chlorodibromomethane and Dichlorobromomethane Limits

It appears that MECs were used to determine interim limits for chlorodibromomethane and dichlorobromomethane. The Log Probit method (rather than MECs) is typically used to calculate interim performance-based limits. The use of MEC data results in more

stringent limits for these constituents and does not accurately reflect performance at the WWTP. The regression of data associated with these constituents yields a log-normally distributed regression equation which can be used to calculate the interim limit at the 99.87 percentile. Interim limits for Calistoga based on MEC and the Log Probit method are included in the following table:

Constituent	MEC Basis	Log Probit Basis
	MDEL (ug/L)	MDEL (ug/L)
Chlorodibromomethane	5.0	9.1
Dichlorobromomethane	13	24

Recommendation:

Include interim limits, based on the Log Probit method, for chlorodibromomethane and dichlorobromomethane in the Tentative Order.

(4) Tertiary Limits for Secondary Discharge

The Water Board has indicated that it will be applying tertiary standards (used for outfall E-1, filtered effluent) to secondary effluent being discharged through outfall E-2. The tertiary standards are technology-based limits and, by definition, can only be met with tertiary treatment (i.e., filtration). Effluent discharged through E-2 is only treated to secondary levels through an activated sludge system. It is inappropriate to place tertiary standards on this secondary discharge.

Recommendation:

Apply secondary limits to the E-2 discharges and tertiary limits to the E-1 discharges.

River to Effluent Flow Ratio

The Water Board is proposing to change the permissible river to effluent flow ratio from the current 10:1 to a future ratio of 25:1 at E-1 (the tertiary outfall). This change has been proposed as a condition for the City to retain the 10:1 dilution credit used to calculate effluent limits. The proposed increased river dilution requirement will be a significant hardship to the City based on the expected effluent disposal and/or storage required until adequate river flow conditions occur. Under current permit conditions, the City may begin discharging to the Napa River on October 1st of each year. However, the river to effluent flow ratio of 10:1 typically does not occur until mid-November. Waiting until a 25:1 flow ratio is available could move the river discharge start date into December. The following issues should be taken into consideration before a final effluent flow ratio is prescribed for Calistoga.

Discharge of Tertiary Treated Water

It appears that the 25:1 flow ratio was proposed in order to be consistent with the St. Helena and Yountville permits. However, Yountville and St. Helena only discharge secondary water to the Napa River. The fact that Calistoga discharges primarily through the E-1 outfall and that all E-1 discharges are tertiary-treated should be taken into account

by the Water Board when determining river to effluent flow ratios. (During 2005, 86% of the effluent discharged from the Calistoga WWTP was through the tertiary outfall, E-1.)

The City's discharge of tertiary effluent to the Napa River began in 1975, and the treatment systems were improved as part of the 2001-2003 WWTP upgrade and expansion. Pollutant loadings to the river were decreased by the addition of filters to the WWTP and the continued discharge of very high quality effluent has helped protect a sensitive area of the Napa River.

SRF Loan Obtained to Upgrade Calistoga WWTP

The City of Calistoga received a SRF loan to assist with an upgrade of its wastewater treatment facilities, which was completed in 2003. As a condition of that loan, the Water Board approved the treatment plant design and verified that effluent quality and storage/disposal methods would be sufficient to meet permit requirements. If permitted disposal conditions are now changed, the plant facilities may no longer be adequate. This action diminishes the value of the SRF loan considerably and will force the City to find additional funding for expansion of its current storage/disposal system.

Financial Hardship for Calistoga

The City of Calistoga is a very small community (population 5,200 with 1,240 sewer connections) located in the northern end of the Napa Valley. The mean household income (MHI) in Calistoga is less than 80% of the Napa County MHI (based on 2000 Census data). In 1997, Calistoga qualified for a State Small Community Grant (the State Water Resources Control Board's low income program) to expand and upgrade the WWTP. In 2001, Calistoga qualified for a grant under the USDA's Water and Environmental Program (WEP) to improve its drinking water system. These grants were necessary to ensure that the City could provide essential and cost-effective infrastructure to its residents without significantly raising the monthly use fees. The additional expense of building storage ponds and/or purchasing land for irrigation disposal, which would be a consequence of the proposed 25:1 dilution ratio, will be difficult for the City's residents to bear, as discussed in the following paragraphs.

Estimated Costs:

During the fall of 2005, river conditions were such that the 10:1 river discharge start date occurred on November 29th. If a 25:1 river discharge ratio were in effect, the discharge start date would not have occurred until December 18th. Waiting until December 18th for river discharge would have forced the City to store or land-apply an additional 5.8 mgal of treated effluent. The costs to handle this extra volume of effluent are calculated below and presented in terms of impact to each household or sewer connection.

Construction of Lined, 10 mgal Storage Pond

(10 mgal)(\$50,000/mgal) = \$500,000 construction estimate

(3 acres)(\$200,000/acre) = \$600,000 land purchase costs

\$1,100,000/1,240 sewer connections = **\$890 per household or sewer connection**

Purchase of City-Owned Land for Dry Season Application

(5.8mgal)(1.1 acre/mgal) = 6.5 acres required

(6.5 acres)(\$200,000/acre) = \$1.3m estimate

\$1.3m/1,240 sewer connections = **\$1,050 per household or sewer connection**

Limited Possibilities for Expansion of the Recycled Water Program

The City of Calistoga currently operates a successful recycled water program. Approximately 82 mgal of recycled water was delivered to the City's users or applied to City-owned sites during the 2005 dry season. However, landscape irrigation or irrigation disposal are the only disposal options available to the City. Agricultural users do not want the City recycled water because of its high boron content (3 mg/L, typical). All of the existing, large landscape irrigators are already connected to the City's recycled water system, and the City actively pursues recycled water connections for any large, proposed new developments.

To expand the recycled water system to nearby agricultural land (primarily vineyards), boron removal would be required for a portion of the treated water. Boron removal is expensive and problematic due to complicated operational processes and the large waste stream that is produced. The estimated cost to reduce boron to 0.5 mg/L (acceptable vineyard value) and treat a fraction of the influent flow is estimated to be \$1.2m. This cost is for a 0.3 mgd ion exchange system.

Installation of boron removal system per household or sewer connection

\$1.2m/1,240 sewer connections = **\$970 per household or sewer connection**

Recommendation:

Retain a 10:1 river to effluent flow ratio for E-1 in the Tentative Order.

Diffuser Installation at E-1

The Water Board is proposing installation of a diffuser at E-1, along with the increase to a 25:1 river to effluent flow ratio. These conditions are being proposed in order for the City to retain the 10:1 dilution credit. It appears that diffuser installation is being proposed in order to provide consistency with the Yountville and St. Helena permits. However, discharge conditions for Calistoga are much different than for Yountville and St. Helena, primarily because Calistoga discharges tertiary water to a narrow, gravel-bottom section of the Napa River. The City does not feel that a 25:1 flow ratio should be mandated for its discharges (as described above) and is also concerned about whether there would actually be a net environmental benefit from installing a diffuser. The

expected impacts associated with installation and operation of a diffuser at E-1 are presented in the following paragraphs.

Effect on Threatened/Endangered Species in Napa River

The City of Calistoga is very concerned that a diffuser will have negative environmental impacts on the Napa River and its fisheries. Gary Martinelli, California Department of Fish and Game (707-944-5570), was contacted to get his perspective on proposed diffuser installation at E-1. Mr. Martinelli expressed his concerns about the effects of installation and operation of a diffuser on the endangered Freshwater Shrimp and threatened Steelhead known to reside in this stretch of the Napa River. Steelhead spawn near the E-1 outfall during January and February, the period when high effluent flow would occur through the diffuser ports. Based on a conventional diffuser design, Mr. Martinelli expects that fish spawning would be discouraged in areas near the diffuser. Mr. Martinelli specified that the Department of Fish and Game be included in the review of potential diffuser designs in order to select a design that will avoid impacts to threatened/endangered species in the Napa River. Incorporation of special features to protect these Napa River species may increase costs to the City for diffuser installation and maintenance.

Diffuser Design and Operation

The E-1 location, where the diffuser would be installed and operated, is a narrow section of the Napa River with a gravel bottom. The gravel bottom is constantly moving with the river flows, shifting locations and redistributing the gravel along the river bed. Water channels and holes are created by this gravel movement, and these channels/holes vary over time, becoming much deeper or shallower in various locations each year. This type of river bed is very different from conditions at the Yountville and St. Helena discharge points. The Yountville and St. Helena outfalls are near deep pools with muddy bottoms. Because of the gravel bed near E-1, the City of Calistoga is concerned about the ability to anchor a diffuser. Operation of the outfall will be expensive and problematic if the diffuser is misaligned or even washed out of the river on a regular basis. Deep excavation of the river bottom may be required to reach a stable substrate and this type of excavation could have substantial environmental impacts and may not be acceptable to the Department of Fish and Game. Another consideration is whether a diffuser in this area can actually achieve adequate mixing within the required river length. Any diffuser design must be site-specific and possibly quite unique because the river is so narrow (20 to 35 ft) at this point. Costs to the City associated with installation and operation of a unique diffuser design will have to be evaluated. The City feels a responsibility to protect the Napa River, but must consider the most cost effective method that has a net environmental benefit.

Recommendation:

Include a provision in the Tentative Order that allows the City to complete an environmental study by 2010 on potential diffuser designs. If a net environmental benefit can be shown, the City will agree to diffuser installation, provided that the diffuser design

is cost effective and reasonably operable/maintainable. Along with diffuser installation, the City must be permitted to maintain the 10:1 flow ratio and dilution credit. If there are no net environmental benefits or if environmental damage is caused by diffuser installation, the City would not install a diffuser. At that point, the City would confer with the Water Board to determine appropriate next steps as part of the 2011 NPDES permit renewal process.

Late Season Discharges to the Napa River

The current NPDES Permit allows discharges to the Napa River from October 1st to May 15th of each year. The permit also allows special requests to be made to the Water Board for “emergency discharges” outside of the permitted discharge period (Discharge Prohibitions, item 4). Napa River flowrates often remain high past May 15th and routine discharges could continue at the permitted river to effluent flow ratio through the end of May and sometimes into June.

Storage capacity concerns have arisen at the WWTP when late spring rains occur or when wet, early fall conditions prevail. The occurrence of late spring rains prevents delivery of recycled water to users (due to lack of demand for City-supplied irrigation water) and forces utilization of valuable pond storage early in the dry season. A wet, early fall causes similar problems, as recycled water users stop needing irrigation water and the City storage ponds fill with excess recycled water and rainfall.

The City would like the option of continuing routine discharges past May 15th, as long as the permitted river to effluent flow ratio is available. The additional discharge in the spring may relieve storage pressures in the fall, when operations staff worries that available storage volume may be exceeded before the start of the river discharge season.

Recommendation:

Include a provision in Tentative Order that specifies procedures for the City to follow when requesting the continuation of routine discharges past May 15th. “Routine discharges” would be defined as discharges to the Napa River under the permitted river to effluent flow ratio. “Emergency discharges” would be defined as a separate type of discharge, requested when the river to effluent flow ratio is below permitted levels. The provision may contain the language provided below.

“In order to obtain approval for a routine river discharge beyond the river discharge period, a letter request must be submitted to the Water Board that includes information on the duration and volume of discharge. This letter should be provided at least 3 days in advance of the proposed discharge. In the letter, the City must provide a narrative description of the water balance and pond storage conditions at the City’s facilities including the rainfall statistics and/or long-range weather forecasts that are prompting the City to make this request. Actual pond depths and the targeted pond depths from the beginning of the reclamation season to the current month must also be included. The Water Board will respond in writing to the City within 48 hours of when the request was first made.”

“In order to obtain approval for an emergency discharge, the City must submit a letter request to the Water Board at least 24 hours in advance of the proposed discharge. The emergency discharge request may be needed when storage ponds are full and the permitted river to effluent flow ratio is not available. The discharge request must include reasons for the discharge, duration of flow, Napa River flowrates, and plans/dates for correcting the problems. The Water Board will respond by phone or in writing to the City within 24 hours of when the request was first made.”

Fact Sheet Appendix F-3

**Receiving Water Hardness, Chloride, and
Total Dissolved Solids (TDS)
Monitoring Data**

Fact Sheet Appendix F-3

City of Calistoga
NPDES Permit Reissuance

Receiving Water Hardness, Chloride, and TDS Monitoring Data

Outfall 001 (E-1)											Outfall 002 (E-2)						
No.	Station	Date	Hardness (mg/L as CaCO3)	Chloride (mg/L)	TDS (mg/L)	No.	Station	Date	Hardness (mg/L as CaCO3)	Chloride (mg/L)	TDS (mg/L)	No.	Station	Date	Hardness (mg/L as CaCO3)	Chloride (mg/L)	TDS (mg/L)
1	C-1	Jan-02	68		180	85	C-4	Jan-02	66		180	169	C-1	Jan-02	68		180
2	C-1	Feb-02	70		150	86	C-4	Feb-02	72		220	170	C-1	Dec-02	64		170
3	C-1	Mar-02	64		200	87	C-4	Mar-02	62		190	171	C-1	Jan-03	58	12	140
4	C-1	Apr-02	74		200	88	C-4	Apr-02	74		240	172	C-1	May-03	60	11	130
5	C-1	May-02	80			89	C-4	May-02	80		240	173	C-1	Dec-03	50	10	140
6	C-1	Nov-02	190		390	90	C-4	Nov-02	140		520	174	C-1	Jan-04	64	10	190
7	C-1	Dec-02	64		170	91	C-4	Dec-02	54		190	175	C-1	Feb-04	70	10	190
8	C-1	Jan-03	40	10	120	92	C-4	Jan-03	50	7	100	176	C-1	Mar-04	50	6	150
9	C-1	Feb-03	70	17	180	93	C-4	Feb-03	70	25	220	177	C-1	Dec-04	40	13	160
10	C-1	Mar-03	78	19	190	94	C-4	Mar-03	74	31	220	178	C-1	Jan-05	50	7.8	86
11	C-1	Apr-03	76	17	180	95	C-4	Apr-03	74	27	220	179	C-1	Mar-05	60	11	130
12	C-1	May-03	60	11	130	96	C-4	May-03	60	12	160	180	C-1	May-05	64	6.8	140
13	C-1	Nov-03	160	90	430	97	C-4	Nov-03	120	120	610	181	C-1	Dec-05	38	3.7	94
14	C-1	Dec-03	40	14	160	98	C-4	Dec-03	40	40	160	182	C-2	Jan-02	68		180
15	C-1	Jan-04	64	10	150	99	C-4	Jan-04	70	20	180	183	C-2	Dec-02	56		150
16	C-1	Feb-04	70	10	170	100	C-4	Feb-04	70	15	190	184	C-2	Jan-03	58	14	150
17	C-1	Mar-04	50	6	120	101	C-4	Mar-04	50	8	140	185	C-2	May-03	60	12	140
18	C-1	Apr-04	100	20	200	102	C-4	Apr-04	90	20	210	186	C-2	Dec-03	50	7	130
19	C-1	May-04	80	20	170	103	C-4	May-04	72	20	190	187	C-2	Jan-04	66	13	150
20	C-1	Nov-04	160	66	400	104	C-4	Nov-04	110	110	370	188	C-2	Feb-04	70	10	160
21	C-1	Dec-04	40	13	120	105	C-4	Dec-04	42	17	140	189	C-2	Mar-04	50	8	140
22	C-1	Jan-05	50	7.8	86	106	C-4	Jan-05	52	9.1	94	190	C-2	Dec-04	38	11	110
23	C-1	Feb-05	70	14	140	107	C-4	Jan-05	70	22	190	191	C-2	Jan-05	50	8.6	84
24	C-1	Mar-05	60	11	130	108	C-4	Mar-05	52	7.8	120	192	C-2	Mar-05	56	7.3	130
25	C-1	Apr-05	62	9	160	109	C-4	Apr-05	60	13	150	193	C-2	May-05	64	8	150
26	C-1	May-05	74	19	170	110	C-4	May-05	62	20	170	194	C-2	Dec-05	40	3.7	110
27	C-1	Nov-05	140	110	400	111	C-4	Nov-05	100	150	530	195	C-3	Jan-02	68		180
28	C-1	Dec-05	86	43	250	112	C-4	Dec-05	86	82	420	196	C-3	Dec-02	68		320
29	C-2	Jan-02	66		180	113	C-5	Jan-02	66		410	197	C-3	Jan-03	62	16	150
30	C-2	Feb-02	72		190	114	C-5	Feb-02	70		220	198	C-3	May-03	60	13	160
31	C-2	Mar-02	62		180	115	C-5	Mar-02	62		200	199	C-3	Dec-03	50	20	190
32	C-2	Apr-02	74		210	116	C-5	Apr-02	64		220	200	C-3	Jan-04	72	20	190
33	C-2	May-02	80		230	117	C-5	May-02	80		240	201	C-3	Feb-04	70	16	200
34	C-2	Nov-02	200		520	118	C-5	Nov-02	190		520	202	C-3	Mar-04	50	8	140
35	C-2	Dec-02	56		150	119	C-5	Dec-02	60		190	203	C-3	Dec-04	40	14	130
36	C-2	Jan-03	40	8	110	120	C-5	Jan-03	54	7	90	204	C-3	Jan-05	52	0.8	87
37	C-2	Feb-03	70	18	180	121	C-5	Feb-03	70	23	220	205	C-3	Mar-05	60	14	160
38	C-2	Mar-03	7	22	180	122	C-5	Mar-03	78	31	220	206	C-3	May-05	62	7.5	140
39	C-2	Apr-03	72	22	180	123	C-5	Apr-03	72	26	200	207	C-3	Dec-05	36	3.8	100
40	C-2	May-03	60	12	140	124	C-5	May-03	60	14	160	208	C-4	Jan-02	68		180
41	C-2	Nov-03	120	120	600	125	C-5	Nov-03	120	130	620	209	C-4	Dec-02	54		190
42	C-2	Dec-03	50	11	160	126	C-5	Dec-03	40	14	180	210	C-4	Jan-03	60	16	150
43	C-2	Jan-04	66	13	150	127	C-5	Jan-04	64	20	200	211	C-4	May-03	60	12	160
44	C-2	Feb-04	70	10	160	128	C-5	Feb-04	70	15	180	212	C-4	Dec-03	40	8	130
45	C-2	Mar-04	50	8	140	129	C-5	Jan-04	50	10	140	213	C-4	Jan-04	70	20	180
46	C-2	Apr-04	90	20	210	130	C-5	Apr-04	80	30	240	214	C-4	Feb-04	70	15	190
47	C-2	May-04	76	20	180	131	C-5	May-04	74	30	220	215	C-4	Mar-04	50	8	140
48	C-2	Nov-04	110	120	590	132	C-5	Nov-04	110	110	600	216	C-4	Dec-04	42	17	140
49	C-2	Dec-04	38	11	110	133	C-5	Dec-04	160	17	140	217	C-4	Jan-05	52	9.1	94
50	C-2	Jan-05	50	8.6	84	134	C-5	Jan-05	52	13	120	218	C-4	Mar-05	52	7.6	120
51	C-2	Feb-05	70	17	160	135	C-5	Feb-05	70	21	200	219	C-4	May-05	60	9.7	140
52	C-2	Mar-05	56	7.3	130	136	C-5	Mar-05	52	8.3	120	220	C-4	Dec-05	38	3.8	100
53	C-2	Apr-05	60	11	140	137	C-5	Apr-05	60	13	120	221	C-5	Jan-02	68		410
54	C-2	May-05	68	18	180	138	C-5	May-05	72	22	180	222	C-5	Dec-02	60		190
55	C-2	Nov-05	110	150	470	139	C-5	Nov-05	100	150	520	223	C-5	Jan-03	60	17	170
56	C-2	Dec-05	82	72	320	140	C-5	Dec-05	84	83	390	224	C-5	May-03	60	14	160
57	C-3	Jan-02	68		180	141	C-6	Jan-02	68		200	225	C-5	Dec-03	50	12	140
58	C-3	Feb-02	76		300	142	C-6	Feb-02	70		230	226	C-5	Jan-04	64	20	200
59	C-3	Mar-02	62		180	143	C-6	Mar-02	62		200	227	C-5	Feb-04	70	15	180
60	C-3	Apr-02	74		220	144	C-6	Apr-02	70		220	228	C-5	Mar-04	50	10	140
61	C-3	May-02	90		300	145	C-6	May-02	80		240	229	C-5	Dec-04	160	17	140
62	C-3	Nov-02	200		810	146	C-6	Nov-02	160		500	230	C-5	Jan-05	52	13	120
63	C-3	Dec-02	68		320	147	C-6	Dec-02	54		160	231	C-5	Mar-05	52	8.3	120
64	C-3	Jan-03	40	7	100	148	C-6	Jan-03	58	7	110	232	C-5	May-05	64	13	120
65	C-3	Feb-03	70	20	200	149	C-6	Feb-03	70	24	210	233	C-5	Dec-05	34	3.9	100
66	C-3	Mar-03	78	30	230	150	C-6	Mar-03	74	29	220	234	C-6	Jan-02	68		200
67	C-3	Apr-03	78	28	220	151	C-6	Apr-03	74	26	150	235	C-6	Dec-02	54		160
68	C-3	May-03	60	13	160	152	C-6	May-03	60	14		236	C-6	Jan-03	60	14	160
69	C-3	Nov-03	120	130	640	153	C-6	Nov-03	120	120	610	237	C-6	May-03	60	14	150
70	C-3	Dec-03	50	30	220	154	C-6	Dec-03	40	15	160	238	C-6	Dec-03	50	8	130
71	C-3	Jan-04	72	13	1180	155	C-6	Jan-04	64	20	170	239	C-6	Jan-04	64	20	170
72	C-3	Feb-04	70	10	200	156	C-6	Feb-04	70	16	190	240	C-6	Feb-04	70	16	190
73	C-3	Mar-04	50	8	140	157	C-6	Mar-04	50	10	140	241	C-6	Mar-04	50	10	140
74	C-3	Apr-04	80	20	210	158	C-6	Apr-04	80	30	230	242	C-6	Dec-04	40	17	100
75	C-3	May-04	78	20	220	159	C-6	May-04	70	30	210	243	C-6	Jan-05	48	11	110
76	C-3	Nov-04	110	120	610	160	C-6	Nov-04	100	120	630	244	C-6	Mar-05	52	8.2	120
77	C-3	Dec-04	40	11	130	161	C-6	Dec-04	40	17	100	245	C-6	May-05	62	10	150
78	C-3	Jan-05	52	8.3	87	162	C-6	Jan-05	48	11	110	246	C-6	Dec-05	36	3.6	96
79	C-3	Feb-05	70	23	200	163	C-6	Feb-05	70	21	180						
80	C-3	Mar-05	60	14	160	164	C-6	Mar-05	52	8.2	120						
81	C-3	Apr-05	64	13	180	165	C-6	Apr-05	60	13	200						
82	C-3	May-05	72	25	200	166	C-6	May-05	64	22	170						
83	C-3	Nov-05	110	150	520	167	C-6	Nov-05	96	140	490						
84	C-3	Dec-05	84	72	330	168	C-6	Dec-05	92	73	380						

Fact Sheet Appendix F-4

Applicable Water Quality Objectives/Water Quality Criteria

City of Calistoga NPDES Permit Reissuance
Applicable Water Quality Objectives/Criteria

Is it a RB2 facility (Y/N)? **Y**
Hardness (mg/L CaCO3) **65**
pH (s.u.) **7.8**

Note: DO NOT enter any value for the column that is NOT applicable
Note: Numbers in blue have formula in the cells - calculates values automatically

# in CTR	PRIORITY POLLUTANTS	Lowest (most stringent) Criteria ^a ug/L	Basin Plan Objectives (ug/L)- Regional Board 2		CTR or NTR Water Quality Criteria (ug/L)				Factors for Metals Freshwater Criteria				Conversion Factor (CF)		
			Freshwater (from Table 3-4)		Freshwater		Human Health for consumption of:		ma	ba	mc	bc	freshwater acute criteria	freshwater chronic criteria	
			1-hr	4-day	CMC (acute)	CCC (chronic)	Water & Organisms	Organisms only							
1	Antimony	14					14								
2	Arsenic	150	340	150	340	150								1	1
3	Beryllium	No Criteria													
4	Cadmium	0.8	2.4	0.5	2.8	1.8			1.128	-3.6867	0.7852	-2.715	0.962	0.927	
5	Chromium (III)	145			1220	145			0.8190	3.6880	0.8190	1.5610	0.316	0.86	
5	Chromium (VI)	11	16	11	16	11							0.982	0.962	
6	Copper	6.5	9.3	6.5	9.3	6.5	1300		0.9422	-1.7000	0.8545	-1.7020	0.96	0.96	
7	Lead	1.8	47	1.8	47	1.8			1.2730	-1.4600	1.2730	-4.7050	0.854	0.854	
8	Mercury	0.025	0.025	2.4			0.05								
9	Nickel	36.2	326	36	326	36	610		0.8460	2.2550	0.8460	0.0584	0.998	0.997	
10	Selenium	5			20	5									
11	Silver	1.9	1.9		1.9				1.7200	-6.5200			0.85		
12	Thallium	1.7					1.7								
13	Zinc	83	83	83	83	83			0.8473	0.8840	0.8473	0.8840	0.978	0.986	
14	Cyanide	5.2			22	5.2	700								
15	Asbestos	7000000					7000000 fibers/L								
16	2,3,7,8-TCDD	0.00000013					0.00000013								
	TCDD TEG	0.00000013					0.00000013								
17	Acrolein	320					320								
18	Acrylonitrile	0.06					0.059								
19	Benzene	1.2					1.2								
20	Bromoform	4.3					4.3								
21	Carbon Tetrachloride	0.3					0.25								
22	Chlorobenzene	680					680								
23	Chloridibromomethane	0.41					0.41								
24	Chloroethane	No Criteria													
25	2-Chloroethylvinyl Ether	No Criteria													
26	Chloroform	No Criteria													
27	Dichlorobromomethane	0.56					0.56								
28	1,1-Dichloroethane	No Criteria													
29	1,2-Dichloroethane	0.380					0.38								
30	1,1-Dichloroethylene	0.057					0.057								
31	1,2-Dichloropropane	0.520					0.52								
32	1,3-Dichloropropylene	10.000					10								
33	Ethylbenzene	3.100					3100								
34	Methyl Bromide	48					48								
35	Methyl Chloride	No Criteria													
36	Methylene Chloride	4.7					4.7								
37	1,1,2,2-Tetrachloroethane	0.17					0.17								
38	Tetrachloroethylene	0.80					0.8								
39	Toluene	6.800					6800								
40	1,2-Trans-Dichloroethylene	700					700								
41	1,1,1-Trichloroethane	No Criteria													
42	1,1,2-Trichloroethane	0.60					0.6								
43	Trichloroethylene	2.70					2.7								
44	Vinyl Chloride	2.00					2								
45	Chlorophenol	120					120								
46	2,4-Dichlorophenol	93					93								
47	2,4-Dimethylphenol	540					540								
48	2-Methyl-4,6-Dinitrophenol	13					13.4								
49	2,4-Dinitrophenol	70					70								
50	2-Nitrophenol	No Criteria													
51	4-Nitrophenol	No Criteria													
52	3-Methyl-4-Chlorophenol	No Criteria													
53	Pentachlorophenol	0.28				19	15	0.28							
54	Phenol	21000					21000								
55	2,4,6-Trichlorophenol	2.10					2.1								
56	Acenaphthene	1,200					1200								
57	Acenaphthylene	No Criteria													
58	Anthracene	9,600					9600								
59	Benzidine	0.0012					0.0012								
60	Benzo(a)Anthracene	0.0044					0.0044								
61	Benzo(a)Pyrene	0.0044					0.0044								
62	Benzo(b)Fluoranthene	0.0044					0.0044								
63	Benzo(ghi)Perylene	No Criteria													
64	Benzo(k)Fluoranthene	0.0044					0.0044								
65	Bis(2-Chloroethoxy)Methane	No Criteria													
66	Bis(2-Chloroethyl)Ether	0.031					0.031								
67	Bis(2-Chloroisopropyl)Ether	1,400					1400								
68	Bis(2-Ethylhexyl)Phthalate	1.80					1.8								
69	4-Bromophenyl Phenyl Ether	No Criteria													
70	Butylbenzyl Phthalate	3,000					3000								
71	2-Chloronaphthalene	1,700					1700								
72	4-Chlorophenyl Phenyl Ether	No Criteria													
73	Chrysene	0.0044					0.0044								
74	Dibenzo(a,h)Anthracene	0.0044					0.0044								
75	1,2-Dichlorobenzene	2,700					2700								
76	1,3-Dichlorobenzene	400					400								
77	1,4-Dichlorobenzene	400					400								
78	3,3'-Dichlorobenzidine	0.040					0.04								
79	Diethyl Phthalate	23,000					23000								

Fact Sheet Appendix F-4

City of Calistoga NPDES Permit Reissuance
Applicable Water Quality Objectives/Criteria

# in CTR	PRIORITY POLLUTANTS	Lowest (most stringent) Criteria ⁶ ug/L	Basin Plan Objectives (ug/L)- Regional Board 2		CTR or NTR Water Quality Criteria (ug/L)				Factors for Metals Freshwater Criteria				Conversion Factor (CF)		
			Freshwater (from Table 3-4)		Freshwater		Human Health for consumption of:		ma	ba	mc	bc	freshwater acute criteria	freshwater chronic criteria	
			1-hr ug/L	4-day ug/L	CMC (acute) ug/L	CCC (chronic) ug/L	Water & organisms ug/L	Organisms only ug/L							
80	Dimethyl Phthalate	313.000						313000							
81	Di-n-Butyl Phthalate	2.700						2700							
82	2,4-Dinitrotoluene	0.11						0.11							
83	2,6-Dinitrotoluene	No Criteria													
84	Di-n-Octyl Phthalate	No Criteria													
85	1,2-Diphenylhydrazine	0.040						0.04							
86	Fluoranthene	300						300							
87	Fluorene	1.300						1300							
88	Hexachlorobenzene	0.00075						0.00075							
89	Hexachlorobutadiene	0.44						0.44							
90	Hexachlorocyclopentadiene	240						240							
91	Hexachloroethane	1.90						1.9							
92	Indeno(1,2,3-cd) Pyrene	0.0044						0.0044							
93	Isophorone	8.4						8.4							
94	naphthalene	No Criteria													
95	Nitrobenzene	17						17							
96	N-Nitrosodimethylamine	0.00069						0.00069							
97	N-Nitrosodi-n-Propylamine	0.005						0.005							
98	N-Nitrosodiphenylamine	5						5							
99	Phenanthrene	No Criteria													
100	Pyrene	960						960							
101	1,2,4-Trichlorobenzene	No Criteria													
102	Aldrin	0.00013				3		0.00013							
103	alpha-BHC	0.0039						0.0039							
104	beta-BHC	0.0140						0.014							
105	gamma-BHC	0.0190				0.95		0.019							
106	delta-BHC	No Criteria													
107	Chlordane	0.00057				2.4	0.0043	0.00057							
108	4,4-DDT	0.00059				1.1	0.001	0.00059							
109	4,4-DDE	0.00059						0.00059							
110	4,4-DDD	0.00083						0.00083							
111	Dieldrin	0.00014				0.24	0.056	0.00014							
112	alpha-Endosulfan	0.0560				0.22	0.056	110							
113	beta-Endosulfan	0.0560				0.22	0.056	110							
114	Endosulfan Sulfate	110						110							
115	Endrin	0.0360				0.086	0.036	0.76							
116	Endrin Aldehyde	0.76						0.76							
117	Heptachlor	0.00021				0.52	0.0038	0.00021							
118	Heptachlor Epoxide	0.00010				0.52	0.0038	0.0001							
119-125	PCBs sum (3)	0.00017					0.014	0.00017							
126	Toxaphene	0.00020				0.73	0.0002	0.00073							
	Tributyltin	0.0720				0.46	0.072								

Notes:

- (1) Receiving body: Napa River
- (2) PCBs sum refers to sum of PCB 1016, 1221, 1232, 1242, 1248, 1254, and 1260

Fact Sheet Appendix F-5

**Reasonable Potential Analysis Results for
Priority Pollutants**

Fact Sheet Appendix F-5(a)

City of Calistoga
NPDES Permit Reissuance

Reasonable Potential Analysis Results for Outfall 001

Beginning	Constituent name	C (ug/L) Lowest (most stringent) Criteria (Enter "No Criteria" for no criteria)	Step 2 Effluent Data Available (Y/N)?	Step 3 Are all data points non-detects (Y/N)?	If all data points ND Enter the min detection limit (MDL) (ug/L)	Enter the pollutant detected max conc (ug/L)	Concentration from the effluent (MEC) (MEC= detected max value; if all ND & MDL<C then MEC = MDL)	Step 4 MEC vs. C 1. If MEC> or =C, effluent limitation is required; 2. If MEC<C, go to Step 5	Step 2 B Available (Y/N)?	Step 3 Are all B data points non-detects (Y/N)?	Step 5 If all data points ND Enter the min detection limit (MDL) (ug/L) Enter the pollutant B detected max conc (ug/L) If all B & ND, is MDL>C?	Step 6 B vs. C If B<C, effluent limitation is required	Step 7 & 8 7) Review other information in the SIP page 4. If information is unavailable or insufficient: 8) the RWQOCB shall establish interim monitoring requirements.	Final Result	
														RPA Result	Reason
85	1,2-Diophenylhydrazine	0.04	Y	Y	0.6	All ND, MinDL<C, Go to Step 5.		Y	Y	0.3	Y	No detected value of B. Step	No	UD; effluent data and B are ND	
86	Fluoranthene	300	Y	Y	0.03	All ND, MDL<C, MEC=MDL	0.03	MEC<C, go to Step 5	Y	Y	0.03	N	No detected value of B. Step	No	UD; MEC-C & B is ND
87	Fluorene	1300	Y	Y	0.02	All ND, MDL<C, MEC=MDL	0.02	MEC<C, go to Step 5	Y	Y	0.02	N	No detected value of B. Step	No	UD; MEC-C & B is ND
88	Hexachlorobenzene	0.00075	Y	Y	0.4	All ND, MinDL<C, Go to Step 5.		Y	Y	0.4	Y	No detected value of B. Step	No	UD; effluent data and B are ND	
89	Hexachlorobutadiene	0.44	Y	Y	0.7	All ND, MinDL<C, Go to Step 5.		Y	Y	0.2	N	No detected value of B. Step	No	UD; effluent data and B are ND	
90	Hexachlorocyclopentadiene	240	Y	Y	0.4	All ND, MDL<C, MEC=MDL	0.4	MEC<C, go to Step 5	Y	Y	0.1	N	No detected value of B. Step	No	UD; MEC-C & B is ND
91	Hexachloroethane	1.9	Y	Y	0.6	All ND, MDL<C, MEC=MDL	0.6	MEC<C, go to Step 5	Y	Y	0.2	N	No detected value of B. Step	No	UD; MEC-C & B is ND
92	Indeno(1,2,3-cd)Pyrene	0.0044	Y	Y	0.02	All ND, MinDL<C, Go to Step 5.		Y	Y	0.04	Y	No detected value of B. Step	No	UD; effluent data and B are ND	
93	Isophorone	8.4	Y	Y	0.5	All ND, MDL<C, MEC=MDL	0.5	MEC<C, go to Step 5	Y	Y	0.3	N	No detected value of B. Step	No	UD; MEC-C & B is ND
94	Naphthalene	No Criteria	Y	Y	0.02	No Criteria	No Criteria	No Criteria	Y	Y	0.05	N	No Criteria	No	No Criteria
95	Nitrobenzene	17	Y	Y	0.7	All ND, MDL<C, MEC=MDL	0.7	MEC<C, go to Step 5	Y	Y	0.3	N	No detected value of B. Step	No	UD; MEC-C & B is ND
96	N-Nitrosodimethylamine	0.00069	Y	Y	0.6	All ND, MinDL<C, Go to Step 5.		Y	Y	0.4	Y	No detected value of B. Step	No	UD; effluent data and B are ND	
97	N-Nitrosodi-n-Propylamine	0.005	Y	Y	0.8	All ND, MinDL<C, Go to Step 5.		Y	Y	0.3	Y	No detected value of B. Step	No	UD; effluent data and B are ND	
98	N-Nitrosodiphenylamine	5	Y	Y	0.6	All ND, MDL<C, MEC=MDL	0.6	MEC<C, go to Step 5	Y	Y	0.4	N	No detected value of B. Step	No	UD; MEC-C & B is ND
99	Phenanthrene	No Criteria	Y	Y	0.02	No Criteria	No Criteria	No Criteria	Y	Y	0.03	N	No Criteria	No	No Criteria
100	Pyrene	360	Y	Y	0.02	All ND, MDL<C, MEC=MDL	0.02	MEC<C, go to Step 5	Y	Y	0.03	N	No detected value of B. Step	No	UD; MEC-C & B is ND
101	1,2,4-Trichlorobenzene	No Criteria	Y	Y	0.6	No Criteria	No Criteria	No Criteria	Y	Y	0.3	N	No Criteria	No	No Criteria
102	Aldrin	0.0013	Y	Y	0.002	All ND, MinDL<C, Go to Step 5.		Y	Y	0.003	Y	No detected value of B. Step	No	UD; effluent data and B are ND	
103	alpha-BHC	0.0039	Y	Y	0.003	All ND, MDL<C, MEC=MDL	0.003	MEC<C, go to Step 5	Y	Y	0.002	N	No detected value of B. Step	No	UD; MEC-C & B is ND
104	beta-BHC	0.014	Y	Y	0.003	All ND, MDL<C, MEC=MDL	0.003	MEC<C, go to Step 5	Y	Y	0.001	N	No detected value of B. Step	No	UD; MEC-C & B is ND
105	gamma-BHC	0.019	Y	Y	0.002	All ND, MDL<C, MEC=MDL	0.002	MEC<C, go to Step 5	Y	Y	0.001	N	No detected value of B. Step	No	UD; MEC-C & B is ND
106	delta-BHC	No Criteria	Y	Y	0.002	No Criteria	No Criteria	No Criteria	Y	Y	0.001	N	No Criteria	No	No Criteria
107	Chlordane	0.00057	Y	Y	0.005	All ND, MinDL<C, Go to Step 5.		Y	Y	0.005	Y	No detected value of B. Step	No	UD; effluent data and B are ND	
108	4,4'-DDT	0.00059	Y	Y	0.002	All ND, MinDL<C, Go to Step 5.		Y	Y	0.001	Y	No detected value of B. Step	No	UD; effluent data and B are ND	
109	4,4'-DDE (linked to DDT)	0.00059	Y	Y	0.002	All ND, MinDL<C, Go to Step 5.		Y	Y	0.001	Y	No detected value of B. Step	No	UD; effluent data and B are ND	
110	4,4'-DDD	0.00083	Y	Y	0.002	All ND, MinDL<C, Go to Step 5.		Y	Y	0.001	Y	No detected value of B. Step	No	UD; effluent data and B are ND	
111	Dieldrin	0.00014	Y	Y	0.002	All ND, MinDL<C, Go to Step 5.		Y	Y	0.002	Y	No detected value of B. Step	No	UD; effluent data and B are ND	
112	alpha-Endosulfan	0.056	Y	Y	0.002	All ND, MDL<C, MEC=MDL	0.002	MEC<C, go to Step 5	Y	Y	0.002	N	No detected value of B. Step	No	UD; MEC-C & B is ND
113	beta-Endosulfan	0.056	Y	Y	0.002	All ND, MDL<C, MEC=MDL	0.002	MEC<C, go to Step 5	Y	Y	0.001	N	No detected value of B. Step	No	UD; MEC-C & B is ND
114	Endosulfan Sulfate	110	Y	Y	0.002	All ND, MDL<C, MEC=MDL	0.002	MEC<C, go to Step 5	Y	Y	0.001	N	No detected value of B. Step	No	UD; MEC-C & B is ND
115	Endrin	0.036	Y	Y	0.002	All ND, MDL<C, MEC=MDL	0.002	MEC<C, go to Step 5	Y	Y	0.002	N	No detected value of B. Step	No	UD; MEC-C & B is ND
116	Endrin Aldehyde	0.76	Y	Y	0.002	All ND, MDL<C, MEC=MDL	0.002	MEC<C, go to Step 5	Y	Y	0.002	N	No detected value of B. Step	No	UD; MEC-C & B is ND
117	Heptachlor	0.00021	Y	Y	0.003	All ND, MinDL<C, Go to Step 5.		Y	Y	0.003	Y	No detected value of B. Step	No	UD; effluent data and B are ND	
118	Heptachlor Epoxide	0.0001	Y	Y	0.002	All ND, MinDL<C, Go to Step 5.		Y	Y	0.002	Y	No detected value of B. Step	No	UD; effluent data and B are ND	
119-125	PCBs sum (2)	0.00017	Y	Y	0.07	All ND, MinDL<C, Go to Step 5.		Y	Y	0.34	Y	No detected value of B. Step	No	UD; effluent data and B are ND	
126	Toxaphene	0.0002	Y	Y	0.15	All ND, MinDL<C, Go to Step 5.		Y	Y	0.2	Y	No detected value of B. Step	No	UD; effluent data and B are ND	
	Tributyltin	0.072	Y	Y	0.000482	All ND, MDL<C, MEC=MDL	0.000482	MEC<C, go to Step 5	Y	Y	0.00139	N	No detected value of B. Step	No	UD; MEC-C & B is ND

a. According to Table 1 of Section (b)(1) of CTR (40CFR 131.38), those criteria should use Basin Plan objectives; criteria for Se and CN are specified by the NTR.
b. Acronyms in the "Final Result" column:
UD: Cannot determine reasonable potential due to the absence of data or because Minimum DL is greater than water quality objective or CTR criteria
IM: Interim monitoring is required

Fact Sheet Appendix F-5(b)

City of Calistoga NPDES Permit Reissuance

RPA Results for Outfall 002

Beginning	C (ug/L) Lowest (most stringent) Criteria (Enter "No Criteria" for no criteria)	Step 2 Effluent Data Available (Y/N)?	Step 3 Are all data points non-defects (Y/N)? If all data points ND Enter the min detection limit (MDL) (ug/L) Enter the pollutant effluent detected max conc (ug/L)	Concentration from the effluent (MEC) (MEC=detected max value; if all ND & MDL<C then MEC=MDL)	Step 4 MEC vs. C 1. If MEC > or =C, effluent limitation is required; 2. If MEC<C, go to Step 5	Step 2 B Available (Y/N)?	Step 3 Are all B data points non-defects (Y/N)?	Step 5 If all data points ND Enter the min detection limit (MDL) (ug/L) Enter the pollutant B detected max conc (ug/L)	Step 6 If all B is ND, is MDL<C? If B-C, effluent limitation is required	Steps 7 & 8 B vs. C 7) Review other information in the SIP page 4. If information is unavailable or insufficient: B) the RWOCB shall establish interim monitoring requirements.	Final Result				
											RPA Result	Reason			
95	Nitrobenzene	17	Y	0.7	All ND, MDL<C, MEC=MDL	0.7	MEC<C, go to Step 5	Y	Y	0.3	N	No detected value of B, Step 7	No	Ud/MEC-C & B is ND	
96	N-Nitrosodimethylamine	0.0069	Y	0.6	All ND, MinDL>C, Go to Step 5, & IM			Y	Y	0.4	Y	No detected value of B, Step 7	No	Ud, effluent data and B are ND	
97	N-Nitrosodi-n-Propylamine	0.005	Y	0.8	All ND, MinDL>C, Go to Step 5, & IM			Y	Y	0.3	Y	No detected value of B, Step 7	No	Ud, effluent data and B are ND	
98	N-Nitrosodiphenylamine	5	Y	0.6	All ND, MDL<C, MEC=MDL	0.6	MEC<C, go to Step 5	Y	Y	0.4	N	No detected value of B, Step 7	No	Ud/MEC-C & B is ND	
99	Phenanthrene	No Criteria	Y	0.02	No Criteria	No Criteria	No Criteria	Y	Y	0.03	N	No Criteria	No Criteria	Uc	No Criteria
100	Pyrene	960	Y	0.02	All ND, MDL<C, MEC=MDL	0.02	MEC<C, go to Step 5	Y	Y	0.03	N	No detected value of B, Step 7	No	Ud/MEC-C & B is ND	
101	1,2,4-Trichlorobenzene	No Criteria	Y	0.6	No Criteria	No Criteria	No Criteria	Y	Y	0.3	N	No Criteria	No Criteria	Uc	No Criteria
102	Aldrin	0.0013	Y	0.002	All ND, MinDL>C, Go to Step 5, & IM			Y	Y	0.003	Y	No detected value of B, Step 7	No	Ud, effluent data and B are ND	
103	alpha-BHC	0.0039	Y	0.003	All ND, MDL<C, MEC=MDL	0.003	MEC<C, go to Step 5	Y	Y	0.002	N	No detected value of B, Step 7	No	Ud/MEC-C & B is ND	
104	beta-BHC	0.014	Y	0.003	All ND, MDL<C, MEC=MDL	0.003	MEC<C, go to Step 5	Y	Y	0.001	N	No detected value of B, Step 7	No	Ud/MEC-C & B is ND	
105	gamma-BHC	0.019	Y	0.002	All ND, MDL<C, MEC=MDL	0.002	MEC<C, go to Step 5	Y	Y	0.001	N	No detected value of B, Step 7	No	Ud/MEC-C & B is ND	
106	delta-BHC	No Criteria	Y	0.002	No Criteria	No Criteria	No Criteria	Y	Y	0.001	N	No Criteria	No Criteria	Uc	No Criteria
107	Chlordane	0.0057	Y	0.005	All ND, MinDL>C, Go to Step 5, & IM			Y	Y	0.005	Y	No detected value of B, Step 7	No	Ud, effluent data and B are ND	
108	4,4'-DDT	0.0059	Y	0.002	All ND, MinDL>C, Go to Step 5, & IM			Y	Y	0.001	Y	No detected value of B, Step 7	No	Ud, effluent data and B are ND	
109	4,4'-DDE (linked to DDT)	0.0059	Y	0.002	All ND, MinDL>C, Go to Step 5, & IM			Y	Y	0.001	Y	No detected value of B, Step 7	No	Ud, effluent data and B are ND	
110	4,4'-DDD	0.0083	Y	0.002	All ND, MinDL>C, Go to Step 5, & IM			Y	Y	0.001	Y	No detected value of B, Step 7	No	Ud, effluent data and B are ND	
111	Dieldrin	0.0014	Y	0.002	All ND, MinDL>C, Go to Step 5, & IM			Y	Y	0.002	Y	No detected value of B, Step 7	No	Ud, effluent data and B are ND	
112	alpha-Endosulfan	0.056	Y	0.002	All ND, MDL<C, MEC=MDL	0.002	MEC<C, go to Step 5	Y	Y	0.002	N	No detected value of B, Step 7	No	Ud/MEC-C & B is ND	
113	beta-Endosulfan	0.056	Y	0.002	All ND, MDL<C, MEC=MDL	0.002	MEC<C, go to Step 5	Y	Y	0.001	N	No detected value of B, Step 7	No	Ud/MEC-C & B is ND	
114	Endosulfan Sulfate	110	Y	0.002	All ND, MDL<C, MEC=MDL	0.002	MEC<C, go to Step 5	Y	Y	0.001	N	No detected value of B, Step 7	No	Ud/MEC-C & B is ND	
115	Endrin	0.036	Y	0.002	All ND, MDL<C, MEC=MDL	0.002	MEC<C, go to Step 5	Y	Y	0.002	N	No detected value of B, Step 7	No	Ud/MEC-C & B is ND	
116	Endrin Aldehyde	0.76	Y	0.002	All ND, MDL<C, MEC=MDL	0.002	MEC<C, go to Step 5	Y	Y	0.002	N	No detected value of B, Step 7	No	Ud/MEC-C & B is ND	
117	Heptachlor	0.0021	Y	0.003	All ND, MinDL>C, Go to Step 5, & IM			Y	Y	0.003	Y	No detected value of B, Step 7	No	Ud, effluent data and B are ND	
118	Heptachlor Epoxide	0.0001	Y	0.002	All ND, MinDL>C, Go to Step 5, & IM			Y	Y	0.002	Y	No detected value of B, Step 7	No	Ud, effluent data and B are ND	
118-125	PCBs sum (2)	0.0017	Y	0.07	All ND, MinDL>C, Go to Step 5, & IM			Y	Y	0.34	Y	No detected value of B, Step 7	No	Ud, effluent data and B are ND	
126	Toxaphene	0.0002	Y	0.15	All ND, MinDL>C, Go to Step 5, & IM			Y	Y	0.2	Y	No detected value of B, Step 7	No	Ud, effluent data and B are ND	
	Tributyltin	0.072	Y	0.00048	All ND, MDL<C, MEC=MDL	0.00048	MEC<C, go to Step 5	Y	Y	0.00139	N	No detected value of B, Step 7	No	Ud/MEC-C & B is ND	

a. According to Table 1 of Section (b)(1) of CTR (40CFR 131.38), those criteria should use Basin Plan objectives; criteria for Se and CN are specified by the NTR.
 b. Acronyms in the "Final Result" column: Ud: Cannot determine reasonable potential due to the absence of data or because Minimum DL is greater than water quality objective or CTR criteria
 IM: Interim monitoring is required

Fact Sheet Appendix F-6

Effluent Data for Priority Pollutants

Fact Sheet Appendix F-6(a)

City of Calistoga
 NPDES Permit Reissuance
 E-1 Effluent Data

CTR #	Pollutant	SAMPLE	Qualifier	RESULT	RL	MDL	UNITS	ANALYTICAL METHOD	NOTES
1	Antimony	01/09/04		10	0.5	0.2	ug/L	EPA 200.8	
1	Antimony	01/04/05		11	0.5	0.14	ug/L	EPA 200.8	
2	Arsenic	11/19/03		14	0.5	0.2	ug/L	EPA 200.8	
2	Arsenic	12/10/03		14	0.5	0.2	ug/L	EPA 200.8	
2	Arsenic	01/09/04		10	0.5	0.2	ug/L	EPA 200.8	
2	Arsenic	02/11/04		13	0.5	0.2	ug/L	EPA 200.8	
2	Arsenic	03/02/04		9.9	0.5	0.2	ug/L	EPA 200.8	
2	Arsenic	04/07/04		16	0.5	0.2	ug/L	EPA 200.8	
2	Arsenic	05/05/04		21	0.5	0.2	ug/L	EPA 200.8	
2	Arsenic	11/17/04		19	0.5	0.14	ug/L	EPA 200.8	
2	Arsenic	12/09/04		16	0.5	0.14	ug/L	EPA 200.8	
2	Arsenic	01/04/05		8.4	0.5	0.14	ug/L	EPA 200.8	
2	Arsenic	02/08/05		14	0.5	0.14	ug/L	EPA 200.8	
2	Arsenic	03/03/05		9	0.5	0.14	ug/L	EPA 200.8	
2	Arsenic	04/05/05		11	0.5	0.14	ug/L	EPA 200.8	
2	Arsenic	05/04/05		14	0.5	0.14	ug/L	EPA 200.8	
2	Arsenic	11/29/05		19	1	0.28	ug/L	EPA 200.8	
2	Arsenic	12/07/05		17	1	0.28	ug/L	EPA 200.8	
2	Arsenic	01/03/06		7.5	0.5	0.2	ug/L	EPA 200.8	
3	Beryllium	01/09/04	ND	0.06	0.2	0.06	ug/L	EPA 200.8	
3	Beryllium	01/04/05	ND	0.06	0.1	0.06	ug/L	EPA 200.8	
4	Cadmium	11/19/03		0.1	0.1	0.03	ug/L	EPA 200.8	
4	Cadmium	12/10/03		0.1	0.1	0.03	ug/L	EPA 200.8	
4	Cadmium	01/09/04	J	0.07	0.1	0.03	ug/L	EPA 200.8	1
4	Cadmium	02/11/04		0.1	0.1	0.03	ug/L	EPA 200.8	
4	Cadmium	03/02/04	ND	0.03	0.1	0.03	ug/L	EPA 200.8	
4	Cadmium	04/07/04		0.2	0.1	0.03	ug/L	EPA 200.8	
4	Cadmium	05/05/04		0.1	0.1	0.03	ug/L	EPA 200.8	
4	Cadmium	11/17/04	J	0.07	0.1	0.03	ug/L	EPA 200.8	1
4	Cadmium	12/09/04	J	0.05	0.1	0.03	ug/L	EPA 200.8	1
4	Cadmium	01/04/05	ND	0.03	0.1	0.03	ug/L	EPA 200.8	
4	Cadmium	02/08/05	ND	0.03	0.1	0.03	ug/L	EPA 200.8	
4	Cadmium	03/03/05	ND	0.03	0.1	0.03	ug/L	EPA 200.8	
4	Cadmium	04/05/05	ND	0.03	0.1	0.03	ug/L	EPA 200.8	
4	Cadmium	05/04/05	J	0.09	0.1	0.03	ug/L	EPA 200.8	
4	Cadmium	11/29/05	J	0.03	0.1	0.03	ug/L	EPA 200.8	
4	Cadmium	12/07/05	ND	0.03	0.1	0.03	ug/L	EPA 200.8	
4	Cadmium	01/03/06	ND	0.04	0.1	0.04	ug/L	EPA 200.8	
5a	Chromium (III)	11/19/03	ND	0.2	0.5	0.2	ug/L	EPA 200.8	
5a	Chromium (III)	12/10/03	J	0.2	0.5	0.2	ug/L	EPA 200.8	1
5a	Chromium (III)	01/09/04	J	0.3	0.5	0.2	ug/L	EPA 200.8	1
5a	Chromium (III)	02/11/04	ND	0.2	0.5	0.2	ug/L	EPA 200.8	
5a	Chromium (III)	03/02/04	ND	0.2	0.5	0.2	ug/L	EPA 200.8	
5a	Chromium (III)	04/07/04	ND	0.2	0.5	0.2	ug/L	EPA 200.8	
5a	Chromium (III)	05/05/04	ND	0.2	0.5	0.2	ug/L	EPA 200.8	2
5a	Chromium (III)	11/17/04	ND	0.2	0.5	0.2	ug/L	EPA 200.8	
5a	Chromium (III)	12/09/04	ND	0.2	0.5	0.2	ug/L	EPA 200.8	
5a	Chromium (III)	01/04/05	ND	0.2	0.5	0.2	ug/L	EPA 200.8	
5a	Chromium (III)	02/08/05	ND	0.2	0.5	0.2	ug/L	EPA 200.8	
5a	Chromium (III)	03/03/05	ND	0.2	0.5	0.2	ug/L	EPA 200.8	
5a	Chromium (III)	04/05/05	ND	0.2	0.5	0.2	ug/L	EPA 200.8	
5a	Chromium (III)	05/04/05	J	0.4	0.5	0.2	ug/L	EPA 200.8	
5a	Chromium (III)	11/29/05	ND	0.4	1	0.4	ug/L	EPA 200.8	2
5a	Chromium (III)	12/07/05	ND	0.4	1	0.4	ug/L	EPA 200.8	2
5a	Chromium (III)	01/03/06	ND	0.2	0.5	0.2	ug/L	EPA 200.8	
5b	Chromium (VI)	01/08/04	ND	10	10		ug/L	SM3500CR	
5b	Chromium (VI)	03/03/04	ND	0.9	10	0.9	ug/L	SM3500CR	
5b	Chromium (VI)	04/07/04	ND	0.9	10	0.9	ug/L	SM3500CR	
5b	Chromium (VI)	05/05/04	ND	0.9	2	0.9	ug/L	SM3500CR	
5b	Chromium (VI)	01/05/05	ND	0.5	10	0.5	ug/L	SM3500CR	
6	Copper	11/19/03		3	0.5	0.3	ug/L	EPA 200.8	
6	Copper	12/10/03		3.8	0.5	0.3	ug/L	EPA 200.8	
6	Copper	01/09/04		4	0.5	0.3	ug/L	EPA 200.8	
6	Copper	02/11/04		4	0.5	0.3	ug/L	EPA 200.8	
6	Copper	03/02/04		4.3	0.5	0.3	ug/L	EPA 200.8	
6	Copper	04/07/04		6.7	0.5	0.3	ug/L	EPA 200.8	
6	Copper	05/05/04		9	1	0.3	ug/L	EPA 200.8	
6	Copper	11/17/04		4.6	0.5	0.28	ug/L	EPA 200.8	
6	Copper	12/09/04		5	0.5	0.28	ug/L	EPA 200.8	
6	Copper	01/04/05		2.1	0.5	0.28	ug/L	EPA 200.8	
6	Copper	02/08/05		3.1	0.5	0.28	ug/L	EPA 200.8	
6	Copper	03/03/05		3.4	0.5	0.28	ug/L	EPA 200.8	
6	Copper	04/05/05		3.4	0.5	0.28	ug/L	EPA 200.8	

Fact Sheet Appendix F-6(a)

City of Calistoga

CTR #	Pollutant	SAMPLE	Qualifier	RESULT	RL	MDL	UNITS	ANALYTICAL METHOD	NOTES
6	Copper	05/04/05		E-1 Effluent	Data	0.28	ug/L	EPA 200.8	
6	Copper	11/29/05		5	1	0.56	ug/L	EPA 200.8	
6	Copper	12/07/05		4.4	1	0.56	ug/L	EPA 200.8	
6	Copper	01/03/06		1.7	0.5	0.08	ug/L	EPA 200.8	
7	Lead	11/19/03		0.82	0.25	0.04	ug/L	EPA 200.8	
7	Lead	12/10/03		0.72	0.25	0.04	ug/L	EPA 200.8	
7	Lead	01/09/04		0.75	0.25	0.04	ug/L	EPA 200.8	
7	Lead	02/11/04		0.94	0.25	0.04	ug/L	EPA 200.8	
7	Lead	03/02/04		0.27	0.25	0.04	ug/L	EPA 200.8	
7	Lead	04/07/04		1.2	0.25	0.04	ug/L	EPA 200.8	
7	Lead	05/05/04		0.28	0.25	0.04	ug/L	EPA 200.8	
7	Lead	11/17/04	J	0.2	0.25	0.04	ug/L	EPA 200.8	1
7	Lead	12/09/04	J	0.17	0.25	0.04	ug/L	EPA 200.8	1
7	Lead	01/04/05	J	0.07	0.25	0.04	ug/L	EPA 200.8	1
7	Lead	02/08/05	J	0.14	0.25	0.04	ug/L	EPA 200.8	1
7	Lead	03/03/05	J	0.16	0.25	0.04	ug/L	EPA 200.8	
7	Lead	04/05/05	J	0.16	0.25	0.04	ug/L	EPA 200.8	
7	Lead	05/04/05		0.35	0.25	0.04	ug/L	EPA 200.8	
7	Lead	11/29/05	J	0.15	0.25	0.04	ug/L	EPA 200.8	
7	Lead	12/07/05		0.35	0.25	0.04	ug/L	EPA 200.8	
7	Lead	01/03/06	J	0.1	0.25	0.07	ug/L	EPA 200.8	
8	Mercury	11/19/03		0.0022	0.0005	0.00024	ug/L	EPA 1631	
8	Mercury	12/10/03		0.0016	0.0005	0.00024	ug/L	EPA 1631	
8	Mercury	01/09/04		0.0023	0.0005	0.00024	ug/L	EPA 1631	
8	Mercury	02/11/04		0.0031	0.0005	0.00024	ug/L	EPA 1631	
8	Mercury	03/03/04		0.0021	0.0005	0.00024	ug/L	EPA 1631	
8	Mercury	04/07/04		0.001	0.0005	0.00024	ug/L	EPA 1631	
8	Mercury	05/05/04		0.0012	0.0005	0.00024	ug/L	EPA 1631	
8	Mercury	11/18/04		0.0012	0.0005	0.00024	ug/L	EPA 1631	
8	Mercury	12/10/04		0.0022	0.0005	0.00024	ug/L	EPA 1631	
8	Mercury	01/04/05		0.0021	0.0005	0.00024	ug/L	EPA 1631	
8	Mercury	02/09/05		0.0009	0.0005	0.00024	ug/L	EPA 1631	
8	Mercury	03/04/05		0.0014	0.0005	0.00024	ug/L	EPA 1631	
8	Mercury	04/06/05		0.0008	0.0005	0.00024	ug/L	EPA 1631	
8	Mercury	05/05/05		0.0018	0.0005	0.00024	ug/L	EPA 1631	
8	Mercury	11/30/05		0.0008	0.0005	0.0002	ug/L	EPA 1631	
8	Mercury	12/08/05		0.0008	0.0005	0.0002	ug/L	EPA 1631	
8	Mercury	01/03/06		0.0015	0.0005	0.0002	ug/L	EPA 1631	
9	Nickel	11/19/03		1.6	0.5	0.2	ug/L	EPA 200.8	
9	Nickel	12/10/03		1.8	0.5	0.2	ug/L	EPA 200.8	
9	Nickel	01/09/04		1.5	0.5	0.2	ug/L	EPA 200.8	
9	Nickel	02/11/04		1.3	0.5	0.2	ug/L	EPA 200.8	
9	Nickel	03/02/04		1.5	0.5	0.2	ug/L	EPA 200.8	
9	Nickel	04/07/04		1.8	0.5	0.2	ug/L	EPA 200.8	
9	Nickel	05/05/04		3	1	0.2	ug/L	EPA 200.8	
9	Nickel	11/17/04		1.5	0.5	0.14	ug/L	EPA 200.8	
9	Nickel	12/09/04		1.4	0.5	0.14	ug/L	EPA 200.8	
9	Nickel	01/04/05		1.3	0.5	0.14	ug/L	EPA 200.8	
9	Nickel	02/08/05		1.8	0.5	0.14	ug/L	EPA 200.8	
9	Nickel	03/03/05		1.4	0.5	0.14	ug/L	EPA 200.8	
9	Nickel	04/05/05		2.1	0.5	0.14	ug/L	EPA 200.8	
9	Nickel	05/04/05		3	0.5	0.14	ug/L	EPA 200.8	
9	Nickel	11/29/05		1.4	1	0.28	ug/L	EPA 200.8	
9	Nickel	12/07/05		2	1	0.28	ug/L	EPA 200.8	
9	Nickel	01/03/06		1.3	0.5	0.2	ug/L	EPA 200.8	
10	Selenium	11/19/03	ND	0.5	2	0.5	ug/L	EPA 200.8	2
10	Selenium	12/10/03	ND	0.5	2.5	0.5	ug/L	EPA 200.8	2
10	Selenium	01/09/04	ND	0.5	1	0.5	ug/L	EPA 200.8	
10	Selenium	02/11/04	ND	0.5	2	0.5	ug/L	EPA 200.8	2
10	Selenium	03/02/04	ND	0.5	1	0.5	ug/L	EPA 200.8	2
10	Selenium	04/07/04	ND	0.5	2	0.5	ug/L	EPA 200.8	2
10	Selenium	05/05/04	ND	0.5	2	0.5	ug/L	EPA 200.8	2
10	Selenium	11/17/04	ND	5	60	5	ug/L	EPA 200.8	2
10	Selenium	12/09/04	ND	2.5	5	2.5	ug/L	EPA 200.8	2
10	Selenium	01/04/05	ND	0.5	4	0.5	ug/L	EPA 200.8	2
10	Selenium	02/08/05	ND	1	8	1	ug/L	EPA 200.8	2
10	Selenium	03/03/05	ND	1	2	1	ug/L	EPA 200.8	2
10	Selenium	04/05/05	ND	1.2	2	1.2	ug/L	EPA 200.8	2
10	Selenium	05/04/05	ND	1	2	1	ug/L	EPA 200.8	2
10	Selenium	11/29/05	ND	0.5	1	0.5	ug/L	EPA 200.8	2
10	Selenium	12/07/05	ND	0.5	1	0.5	ug/L	EPA 200.8	
10	Selenium	01/03/06	ND	0.7	1	0.7	ug/L	EPA 200.8	
11	Silver	11/19/03	ND	0.02	0.1	0.02	ug/L	EPA 200.8	
11	Silver	12/10/03	J	0.02	0.1	0.02	ug/L	EPA 200.8	1
11	Silver	01/09/04	ND	0.02	0.1	0.02	ug/L	EPA 200.8	

Fact Sheet Appendix F-6(a)

City of Calistoga

CTR #	Pollutant	SAMPLE	Qualifier	RESULT	RL	MDL	UNITS	ANALYTICAL METHOD	NOTES
11	Silver	02/11/04	ND	E-1 (Effluent Data)	0.02	0.02	ug/L	EPA 200.8	
11	Silver	03/02/04	ND	0.02	0.1	0.02	ug/L	EPA 200.8	
11	Silver	04/07/04	ND	0.02	0.1	0.02	ug/L	EPA 200.8	
11	Silver	05/05/04	J	0.02	0.1	0.02	ug/L	EPA 200.8	
11	Silver	11/17/04	ND	0.03	0.1	0.03	ug/L	EPA 200.8	
11	Silver	12/09/04	ND	0.03	0.1	0.03	ug/L	EPA 200.8	
11	Silver	01/04/05	ND	0.03	0.1	0.03	ug/L	EPA 200.8	
11	Silver	02/08/05	ND	0.03	0.1	0.03	ug/L	EPA 200.8	
11	Silver	03/03/05	ND	0.03	0.1	0.03	ug/L	EPA 200.8	
11	Silver	04/05/05	ND	0.03	0.1	0.03	ug/L	EPA 200.8	
11	Silver	05/04/05	ND	0.03	0.1	0.03	ug/L	EPA 200.8	
11	Silver	11/29/05	ND	0.03	0.1	0.03	ug/L	EPA 200.8	
11	Silver	12/07/05	ND	0.03	0.1	0.03	ug/L	EPA 200.8	
11	Silver	01/03/06	ND	0.02	0.1	0.02	ug/L	EPA 200.8	
12	Thallium	01/09/04	0.03	ND	0.1	0.03	ug/L	EPA 200.8	
12	Thallium	01/04/05	0.03	ND	0.1	0.03	ug/L	EPA 200.8	
13	Zinc	11/19/03		43	1	0.3	ug/L	EPA 200.8	
13	Zinc	12/10/03		35	2	0.3	ug/L	EPA 200.8	
13	Zinc	01/09/04		35	2	0.3	ug/L	EPA 200.8	
13	Zinc	02/11/04		41	1	0.3	ug/L	EPA 200.8	
13	Zinc	03/02/04		25	2	0.3	ug/L	EPA 200.8	
13	Zinc	04/07/04		60	2	0.3	ug/L	EPA 200.8	
13	Zinc	05/05/04		50	4	0.3	ug/L	EPA 200.8	
13	Zinc	11/17/04		46	2	0.3	ug/L	EPA 200.8	
13	Zinc	12/09/04		29	1	0.3	ug/L	EPA 200.8	
13	Zinc	01/04/05		9	1	0.3	ug/L	EPA 200.8	
13	Zinc	02/08/05		27	1	0.3	ug/L	EPA 200.8	
13	Zinc	03/03/05		24	1	0.3	ug/L	EPA 200.8	
13	Zinc	04/05/05		24	1	0.3	ug/L	EPA 200.8	
13	Zinc	05/04/05		65	1	0.3	ug/L	EPA 200.8	
13	Zinc	11/29/05		35	2	0.6	ug/L	EPA 200.8	
13	Zinc	12/07/05		54	2	0.6	ug/L	EPA 200.8	
13	Zinc	01/03/06		8	1	0.8	ug/L	EPA 200.8	
14	Cyanide	11/18/03	J	1.9	3	0.9	ug/L	EPA 335.2	1
14	Cyanide	12/09/03	ND	3	3		ug/L	EPA 335.2	
14	Cyanide	01/09/04	ND	3	3	0.9	ug/L	EPA 335.2	
14	Cyanide	02/10/04		4	3		ug/L	EPA 335.2	
14	Cyanide	03/02/04		6	3	0.9	ug/L	EPA 335.2	
14	Cyanide	04/06/04		6	3	0.9	ug/L	EPA 335.2	
14	Cyanide	05/11/04	J	1	3		ug/L	EPA 335.2	1
14	Cyanide	11/17/04		4.7	3	0.8	ug/L	EPA 335.2	
14	Cyanide	12/08/04	ND	0.8	3	0.8	ug/L	EPA 335.2	
14	Cyanide	01/04/05	ND	0.8	3	0.8	ug/L	EPA 335.2	
14	Cyanide	02/08/05	ND	0.8	3	0.8	ug/L	EPA 335.2	
14	Cyanide	03/03/05	ND	0.8	3	0.8	ug/L	EPA 335.2	
14	Cyanide	04/05/05		4.3	3	0.8	ug/L	EPA 335.2	
14	Cyanide	05/04/05	ND	0.8	3	0.8	ug/L	EPA 335.2	
14	Cyanide	11/29/05		3.9	3	0.8	ug/L	EPA 335.2	
14	Cyanide	12/13/05		4.4	3	0.8	ug/L	EPA 335.2	
14	Cyanide	01/03/06		4.6	3	0.8	ug/L	EPA 335.2	
16	2,3,7,8-TCDD (Dioxin)	01/09/04	ND	0.637	1.81	0.637	pg/L	EPA 1613	
16	2,3,7,8-TCDD (Dioxin)	01/05/05	ND	0.699	0.276	0.699	pg/L	EPA 1613	
16	2,3,7,8-TCDD (Dioxin)	01/03/06	ND	1.18	1.18		pg/L	EPA 1613	
17	Acrolein	01/09/04	ND	5	5	1	ug/L	EPA 624	
17	Acrolein	01/04/05	ND	0.56	5	0.56	ug/L	EPA 624	5
17	Acrolein	01/03/06	ND	0.56	5	0.56	ug/L	EPA 624	6
18	Acrylonitrile	01/09/04	ND	1	2	1	ug/L	EPA 624	
18	Acrylonitrile	01/04/05	ND	0.33	2	0.33	ug/L	EPA 624	
18	Acrylonitrile	01/03/06	ND	0.33	2	0.33	ug/L	EPA 624	
19	Benzene	01/09/04	ND	0.3	0.5	0.3	ug/L	EPA 624	
19	Benzene	01/04/05	ND	0.06	0.5	0.06	ug/L	EPA 624	
19	Benzene	01/03/06	ND	0.06	0.5	0.06	ug/L	EPA 624	
20	Bromoform	01/09/04	J	0.4	0.5	0.2	ug/L	EPA 624	1
20	Bromoform	01/04/05	J	0.2	0.5	0.07	ug/L	EPA 624	1
20	Bromoform	01/03/06	J	0.3	0.5	0.07	ug/L	EPA 624	
21	Carbon Tetrachloride	01/09/04	ND	0.42	0.5	0.42	ug/L	EPA 624	
21	Carbon Tetrachloride	01/04/05	ND	0.06	0.5	0.06	ug/L	EPA 624	
21	Carbon Tetrachloride	01/03/06	J	0.2	0.5	0.06	ug/L	EPA 624	
22	Chlorobenzene	01/09/04	ND	0.3	0.5	0.3	ug/L	EPA 624	
22	Chlorobenzene	01/04/05	ND	0.06	0.5	0.06	ug/L	EPA 624	
22	Chlorobenzene	01/03/06	ND	0.06	0.5	0.06	ug/L	EPA 624	
23	Chlorodibromomethane	01/09/04		4.5	0.5	0.3	ug/L	EPA 624	
23	Chlorodibromomethane	01/04/05		2.9	0.5	0.3	ug/L	EPA 624	
23	Chlorodibromomethane	01/03/06		3	0.5	0.07	ug/L	EPA 624	
24	Chloroethane	01/09/04	ND	0.34	0.5	0.34	ug/L	EPA 624	

Fact Sheet Appendix F-6(a)

City of Calistoga

CTR #	Pollutant	SAMPLE	Qualifier	RESULT	RL	MDL	UNITS	ANALYTICAL METHOD	NOTES
24	Chloroethane	01/04/05	ND	E-1 (Effluent Data)		0.07	ug/L	EPA 624	
24	Chloroethane	01/03/06	ND	0.07	0.5	0.07	ug/L	EPA 624	
25	2-Chloroethylvinyl Ether	01/09/04	ND	0.32	1	0.32	ug/L	EPA 624	
25	2-Chloroethylvinyl Ether	01/04/05	ND	0.1	1	0.1	ug/L	EPA 624	
25	2-Chloroethylvinyl Ether	01/03/06	ND	0.1	1	0.1	ug/L	EPA 624	7
26	Chloroform	01/09/04		34	0.5	0.31	ug/L	EPA 624	
26	Chloroform	01/04/05		30	0.5	0.05	ug/L	EPA 624	
26	Chloroform	01/03/06		16	0.5	0.05	ug/L	EPA 624	
27	Dichlorobromomethane	01/09/04		13	0.5	0.2	ug/L	EPA 624	
27	Dichlorobromomethane	01/04/05		10	0.5	0.07	ug/L	EPA 624	
27	Dichlorobromomethane	01/03/06		9	0.5	0.06	ug/L	EPA 624	
28	1,1-Dichloroethane	01/09/04	ND	0.34	0.5	0.34	ug/L	EPA 624	
28	1,1-Dichloroethane	01/04/05	ND	0.05	0.5	0.05	ug/L	EPA 624	
28	1,1-Dichloroethane	01/03/06	ND	0.05	0.5	0.05	ug/L	EPA 624	
29	1,2-Dichloroethane	01/09/04	ND	0.2	0.5	0.2	ug/L	EPA 624	
29	1,2-Dichloroethane	01/04/05	ND	0.06	0.5	0.06	ug/L	EPA 624	
29	1,2-Dichloroethane	01/03/06	ND	0.06	0.5	0.06	ug/L	EPA 624	
30	1,1-Dichloroethene	01/09/04	ND	0.49	0.5	0.49	ug/L	EPA 624	
30	1,1-Dichloroethene	01/04/05	ND	0.06	0.5	0.06	ug/L	EPA 624	
30	1,1-Dichloroethene	01/03/06	ND	0.07	0.5	0.07	ug/L	EPA 624	
31	1,2-Dichloropropane	01/09/04	ND	0.2	0.5	0.2	ug/L	EPA 624	
31	1,2-Dichloropropane	01/04/05	ND	0.05	0.5	0.05	ug/L	EPA 624	
31	1,2-Dichloropropane	01/03/06	ND	0.05	0.5	0.05	ug/L	EPA 624	
32	cis-1,3-Dichloropropene	01/09/04	ND	0.2	0.5	0.2	ug/L	EPA 624	
32	trans-1,3-Dichloropropene	01/09/04	ND	0.3	0.5	0.3	ug/L	EPA 624	
32	cis-1,3-Dichloropropene	01/04/05	ND	0.06	0.5	0.06	ug/L	EPA 624	
32	trans-1,3-Dichloropropene	01/04/05	ND	0.06	0.5	0.06	ug/L	EPA 624	
32	cis-1,3-Dichloropropene	01/03/06	ND	0.06	0.5	0.06	ug/L	EPA 624	
32	trans-1,3-Dichloropropene	01/03/06	ND	0.05	0.5	0.05	ug/L	EPA 624	
33	Ethylbenzene	01/09/04	ND	0.4	0.5	0.4	ug/L	EPA 624	
33	Ethylbenzene	01/04/05	ND	0.06	0.5	0.06	ug/L	EPA 624	
33	Ethylbenzene	01/03/06	ND	0.06	0.5	0.06	ug/L	EPA 624	
34	Methyl Bromide	01/09/04	ND	0.42	0.5	0.42	ug/L	EPA 624	
34	Methyl Bromide	01/04/05	ND	0.05	0.5	0.05	ug/L	EPA 624	
34	Methyl Bromide	01/03/06	ND	0.05	0.5	0.05	ug/L	EPA 624	
35	Methyl Chloride	01/09/04		0.8	0.5	0.46	ug/L	EPA 624	
35	Methyl Chloride	01/04/05	ND	0.04	0.5	0.04	ug/L	EPA 624	
35	Methyl Chloride	01/03/06		1	0.5	0.04	ug/L	EPA 624	
36	Methylene Chloride	01/09/04	ND	0.4	0.5	0.4	ug/L	EPA 624	
36	Methylene Chloride	01/04/05	ND	0.07	0.5	0.07	ug/L	EPA 624	
36	Methylene Chloride	01/03/06	J	0.37	0.5	0.07	ug/L	EPA 624	
37	1,1,2,2-Tetrachloroethane	01/09/04	ND	0.3	0.5	0.3	ug/L	EPA 624	
37	1,1,2,2-Tetrachloroethane	01/04/05	ND	0.06	0.5	0.06	ug/L	EPA 624	
37	1,1,2,2-Tetrachloroethane	01/03/06	ND	0.06	0.5	0.06	ug/L	EPA 624	
38	Tetrachloroethylene	01/09/04	ND	0.44	0.5	0.44	ug/L	EPA 624	
38	Tetrachloroethylene	01/04/05	ND	0.06	0.5	0.06	ug/L	EPA 624	
38	Tetrachloroethylene	01/03/06	ND	0.06	0.5	0.06	ug/L	EPA 624	
39	Toluene	01/09/04	ND	0.32	0.5	0.32	ug/L	EPA 624	
39	Toluene	01/04/05	ND	0.06	0.5	0.06	ug/L	EPA 624	
39	Toluene	01/03/06	ND	0.06	0.5	0.06	ug/L	EPA 624	
40	1,2-trans-Dichloroethylene	01/09/04	ND	0.43	0.5	0.43	ug/L	EPA 624	
40	1,2-trans-Dichloroethylene	01/04/05	ND	0.05	0.5	0.05	ug/L	EPA 624	
40	1,2-trans-Dichloroethylene	01/03/06	ND	0.05	0.5	0.05	ug/L	EPA 624	
41	1,1,1-Trichloroethane	01/09/04	ND	0.49	0.5	0.49	ug/L	EPA 624	
41	1,1,1-Trichloroethane	01/04/05	ND	0.06	0.5	0.06	ug/L	EPA 624	
41	1,1,1-Trichloroethane	01/03/06	ND	0.06	0.5	0.06	ug/L	EPA 624	
42	1,1,2-Trichloroethane	01/09/04	ND	0.3	0.5	0.3	ug/L	EPA 624	
42	1,1,2-Trichloroethane	01/04/05	ND	0.07	0.5	0.07	ug/L	EPA 624	
42	1,1,2-Trichloroethane	01/03/06	ND	0.07	0.5	0.07	ug/L	EPA 624	
43	Trichloroethene	01/09/04	ND	0.3	0.5	0.3	ug/L	EPA 624	
43	Trichloroethene	01/04/05	ND	0.06	0.5	0.06	ug/L	EPA 624	
43	Trichloroethene	01/03/06	ND	0.06	0.5	0.06	ug/L	EPA 624	
44	Vinyl Chloride	01/09/04	ND	0.47	0.5	0.47	ug/L	EPA 624	
44	Vinyl Chloride	01/04/05	ND	0.05	0.5	0.05	ug/L	EPA 624	
44	Vinyl Chloride	01/03/06	ND	0.05	0.5	0.05	ug/L	EPA 624	
45	2-Chlorophenol	01/09/04	ND	0.6	2	0.6	ug/L	EPA 625	
45	2-Chlorophenol	01/04/05	ND	1.2	2	1.2	ug/L	EPA 625	4
45	2-Chlorophenol	01/03/06	ND	1.2	2	1.2	ug/L	EPA 625	4
46	2,4-Dichlorophenol	01/09/04	ND	0.7	1	0.7	ug/L	EPA 625	
46	2,4-Dichlorophenol	01/04/05	ND	0.9	1	0.9	ug/L	EPA 625	4
46	2,4-Dichlorophenol	01/03/06	ND	0.9	1	0.9	ug/L	EPA 625	4
47	2,4-Dimethylphenol	01/09/04	ND	0.9	2	0.9	ug/L	EPA 625	
47	2,4-Dimethylphenol	01/04/05	ND	1.1	2	1.1	ug/L	EPA 625	4
47	2,4-Dimethylphenol	01/03/06	ND	1.1	2	1.1	ug/L	EPA 625	4
48	2-Methyl-4,6-Dinitrophenol	01/09/04	ND	0.9	5	0.9	ug/L	EPA 625	

Fact Sheet Appendix F-6(a)

City of Calistoga

CTR #	Pollutant	SAMPLE	Qualifier	RESULT	RL	MDL	UNITS	ANALYTICAL METHOD	NOTES
48	2-Methyl-4,6-Dinitrophenol	01/04/05	ND	E-1 Effluent	Data	2	ug/L	EPA 625	4
48	2-Methyl-4,6-Dinitrophenol	01/03/06	ND	2	5	2	ug/L	EPA 625	4
49	2,4-Dinitrophenol	01/09/04	ND	0.6	5	0.6	ug/L	EPA 625	
49	2,4-Dinitrophenol	01/04/05	ND	2	5	2	ug/L	EPA 625	4
49	2,4-Dinitrophenol	01/03/06	ND	2	5	2	ug/L	EPA 625	4
50	2-Nitrophenol	01/09/04	ND	0.7	5	0.7	ug/L	EPA 625	
50	2-Nitrophenol	01/04/05	ND	1.1	5	1.1	ug/L	EPA 625	4
50	2-Nitrophenol	01/03/06	ND	1.1	5	1.1	ug/L	EPA 625	4
51	4-Nitrophenol	01/09/04	ND	0.6	5	0.6	ug/L	EPA 625	
51	4-Nitrophenol	01/04/05	<	5	5	1	ug/L	EPA 625	4
51	4-Nitrophenol	01/03/06	<	5	5	1	ug/L	EPA 625	4
52	4-Chloro-3-Methylphenol	01/09/04	<	1	1	0.5	ug/L	EPA 625	
52	4-Chloro-3-Methylphenol	01/04/05	ND	0.93	1	0.93	ug/L	EPA 625	4
52	4-Chloro-3-Methylphenol	01/03/06	ND	0.93	1	0.93	ug/L	EPA 625	4
53	Pentachlorophenol	01/09/04	ND	0.9	1	0.9	ug/L	EPA 625	
53	Pentachlorophenol	01/04/05	ND	0.98	1	0.98	ug/L	EPA 625	4
53	Pentachlorophenol	01/03/06	ND	0.98	1	0.98	ug/L	EPA 625	4
54	Phenol	01/09/04	ND	0.4	1	0.4	ug/L	EPA 625	
54	Phenol	01/04/05	ND	0.8	1	0.8	ug/L	EPA 625	4
54	Phenol	01/03/06	ND	0.8	1	0.8	ug/L	EPA 625	4
55	2,4,6-Trichlorophenol	01/09/04	ND	0.6	5	0.6	ug/L	EPA 625	
55	2,4,6-Trichlorophenol	01/04/05	ND	2	5	2	ug/L	EPA 625	4
55	2,4,6-Trichlorophenol	01/03/06	ND	2	5	2	ug/L	EPA 625	4
56	Acenaphthene	11/19/03	ND	0.17	0.3	0.17	ug/L	EPA 610	
56	Acenaphthene	01/09/04	ND	0.17	0.3	0.17	ug/L	EPA 610	
56	Acenaphthene	01/04/05	ND	0.032	0.32	0.032	ug/L	EPA 610	
56	Acenaphthene	01/03/06	ND	0.03	0.3	0.03	ug/L	EPA 610	
57	Acenaphthylene	11/19/03	ND	0.03	0.2	0.03	ug/L	EPA 610	
57	Acenaphthylene	01/09/04	ND	0.03	0.2	0.03	ug/L	EPA 610	
57	Acenaphthylene	01/04/05	ND	0.021	0.21	0.021	ug/L	EPA 610	
57	Acenaphthylene	01/03/06	ND	0.02	0.2	0.02	ug/L	EPA 610	
58	Anthracene	11/19/03	ND	0.16	0.3	0.16	ug/L	EPA 610	
58	Anthracene	01/09/04	ND	0.16	0.3	0.16	ug/L	EPA 610	
58	Anthracene	01/04/05	ND	0.032	0.32	0.032	ug/L	EPA 610	
58	Anthracene	01/03/06	ND	0.03	0.3	0.03	ug/L	EPA 610	
59	Benzidine	01/09/04	ND	1	5	1	ug/L	EPA 625	
59	Benzidine	01/04/05	ND	1	5	1	ug/L	EPA 625	4
59	Benzidine	01/03/06	ND	1	5	1	ug/L	EPA 625	4
60	Benzo(a)Anthracene	11/19/03	ND	0.12	0.3	0.12	ug/L	EPA 610	
60	Benzo(a)Anthracene	01/09/04	ND	0.12	0.3	0.12	ug/L	EPA 610	
60	Benzo(a)anthracene	02/11/04	ND	0.12	0.3	0.12	ug/L	EPA 610	
60	Benzo(a)Anthracene	01/04/05	ND	0.021	0.32	0.021	ug/L	EPA 610	
60	Benzo(a)Anthracene	01/03/06	ND	0.02	0.3	0.02	ug/L	EPA 610	
61	Benzo(a)Pyrene	11/19/03	ND	0.09	0.3	0.09	ug/L	EPA 610	
61	Benzo(a)Pyrene	01/09/04	ND	0.09	0.3	0.09	ug/L	EPA 610	
61	Benzo(a)Pyrene	01/04/05	ND	0.021	0.32	0.021	ug/L	EPA 610	
61	Benzo(a)Pyrene	01/03/06	ND	0.02	0.3	0.02	ug/L	EPA 610	
62	Benzo(b)Fluoranthene	11/19/03	ND	0.11	0.3	0.11	ug/L	EPA 610	
62	Benzo(b)Fluoranthene	01/09/04	ND	0.11	0.3	0.11	ug/L	EPA 610	
62	Benzo(b)Fluoranthene	01/04/05	ND	0.032	0.32	0.032	ug/L	EPA 610	
62	Benzo(b)Fluoranthene	01/03/06	ND	0.02	0.3	0.02	ug/L	EPA 610	
63	Benzo(ghi)Perylene	11/19/03	ND	0.06	0.1	0.06	ug/L	EPA 610	
63	Benzo(ghi)Perylene	01/09/04	ND	0.06	0.1	0.06	ug/L	EPA 610	
63	Benzo(ghi)Perylene	01/04/05	ND	0.032	0.11	0.032	ug/L	EPA 610	
63	Benzo(ghi)Perylene	01/03/06	ND	0.02	0.1	0.02	ug/L	EPA 610	
64	Benzo(k)Fluoranthene	11/19/03	ND	0.16	0.3	0.16	ug/L	EPA 610	
64	Benzo(k)Fluoranthene	01/09/04	ND	0.16	0.3	0.16	ug/L	EPA 610	
64	Benzo(k)Fluoranthene	01/04/05	ND	0.043	0.32	0.043	ug/L	EPA 610	
64	Benzo(k)Fluoranthene	01/03/06	<	0.02	0.3	0.02	ug/L	EPA 610	
65	Bis(2-Chloroethoxy)Methane	01/09/04	<	0.9	5	0.9	ug/L	EPA 625	
65	Bis(2-Chloroethoxy)Methane	01/04/05	<	0.8	5	0.8	ug/L	EPA 625	4
65	Bis(2-Chloroethoxy)Methane	01/03/06	<	0.8	5	0.8	ug/L	EPA 625	4
66	Bis(2-Chloroethyl)Ether	01/09/04	<	0.7	1	0.7	ug/L	EPA 625	
66	Bis(2-Chloroethyl)Ether	01/04/05	<	0.7	1	0.7	ug/L	EPA 625	4
66	Bis(2-Chloroethyl)Ether	01/03/06	<	0.7	1	0.7	ug/L	EPA 625	4
67	Bis(2-Chloroisopropyl)Ether	01/09/04	ND	0.6	2	0.6	ug/L	EPA 625	
67	Bis(2-Chloroisopropyl)Ether	01/04/05	ND	0.7	2	0.7	ug/L	EPA 625	4
67	Bis(2-Chloroisopropyl)Ether	01/03/06	ND	0.7	2	0.7	ug/L	EPA 625	4
68	Bis(2-Ethylhexyl)Phthalate	11/19/03							
68	Bis(2-Ethylhexyl)Phthalate	01/09/04	ND	0.8	5	0.8	ug/L	EPA 625	
68	Bis(2-Ethylhexyl)Phthalate	01/04/05	ND	0.5	3	0.5	ug/L	EPA 625	4
68	Bis(2-Ethylhexyl)Phthalate	01/03/06	ND	0.5	3	0.5	ug/L	EPA 625	4
69	4-Bromophenyl Phenyl Ether	11/19/03	ND	0.4	5	0.4	ug/L	EPA 625	
69	4-Bromophenyl Phenyl Ether	01/09/04	ND	0.4	5	0.4	ug/L	EPA 625	
69	4-Bromophenyl Phenyl Ether	01/04/05	ND	2	5	2	ug/L	EPA 625	4

Fact Sheet Appendix F-6(a)

City of Calistoga

CTR #	Pollutant	SAMPLE	Qualifier	RESULT	RL	MDL	UNITS	ANALYTICAL METHOD	NOTES
69	4-Bromophenyl Phenyl Ether	01/03/06	ND	E-1 Effluent Data		2	ug/L	EPA 625	4
70	Butylbenzyl Phthalate	11/19/03	ND	0.8	5	0.8	ug/L	EPA 625	
70	Butylbenzyl Phthalate	01/09/04	ND	0.8	5	0.8	ug/L	EPA 625	
70	Butylbenzyl Phthalate	01/04/05	ND	2	5	2	ug/L	EPA 625	4
70	Butylbenzyl Phthalate	01/03/06	ND	2	5	2	ug/L	EPA 625	4
71	2-Chloronaphthalene	11/19/03	ND	0.5	5	0.5	ug/L	EPA 625	
71	2-Chloronaphthalene	01/09/04	ND	0.5	5	0.5	ug/L	EPA 625	
71	2-Chloronaphthalene	01/04/05	ND	0.6	5	0.6	ug/L	EPA 625	4
71	2-Chloronaphthalene	01/03/06	ND	0.6	5	0.6	ug/L	EPA 625	4
72	4-Chlorophenyl Phenyl Ether	11/19/03	ND	0.5	5	0.5	ug/L	EPA 625	
72	4-Chlorophenyl Phenyl Ether	01/09/04	ND	0.5	5	0.5	ug/L	EPA 625	
72	4-Chlorophenyl Phenyl Ether	01/04/05	ND	2	5	2	ug/L	EPA 625	4
72	4-Chlorophenyl Phenyl Ether	01/03/06	ND	2	5	2	ug/L	EPA 625	4
73	Chrysene	11/19/03	ND	0.14	0.3	0.14	ug/L	EPA 610	
73	Chrysene	01/09/04	ND	0.14	0.3	0.14	ug/L	EPA 610	
73	Chrysene	01/04/05	ND	0.043	0.32	0.043	ug/L	EPA 610	
73	Chrysene	01/03/06	ND	0.02	0.3	0.02	ug/L	EPA 610	
74	Dibenzo(a,h)Anthracene	11/19/03	ND	0.04	0.1	0.04	ug/L	EPA 610	
74	Dibenzo(a,h)Anthracene	01/09/04	ND	0.04	0.1	0.04	ug/L	EPA 610	
74	Dibenzo(a,h)Anthracene	01/04/05	ND	0.032	0.11	0.032	ug/L	EPA 610	
74	Dibenzo(a,h)Anthracene	01/03/06	ND	0.03	0.1	0.03	ug/L	EPA 610	
75	1,2-Dichlorobenzene	11/19/03	ND	0.2	0.5	0.2	ug/L	EPA 624	
75	1,2-Dichlorobenzene	01/09/04	ND	0.2	0.5	0.2	ug/L	EPA 624	
75	1,2-Dichlorobenzene	01/04/05	ND	0.05	0.5	0.05	ug/L	EPA 624	
75	1,2-Dichlorobenzene	01/03/06	ND	0.06	0.5	0.06	ug/L	EPA 624	
76	1,3-Dichlorobenzene	11/19/03	ND	0.3	0.5	0.3	ug/L	EPA 624	
76	1,3-Dichlorobenzene	01/09/04	ND	0.3	0.5	0.3	ug/L	EPA 624	
76	1,3-Dichlorobenzene	01/04/05	ND	0.07	0.5	0.07	ug/L	EPA 624	
76	1,3-Dichlorobenzene	01/03/06	ND	0.07	0.5	0.07	ug/L	EPA 624	
77	1,4-Dichlorobenzene	11/19/03	ND	0.3	0.5	0.3	ug/L	EPA 624	
77	1,4-Dichlorobenzene	01/09/04	ND	0.3	0.5	0.3	ug/L	EPA 624	
77	1,4-Dichlorobenzene	01/04/05	J	0.1	0.5	0.06	ug/L	EPA 624	1
77	1,4-Dichlorobenzene	01/03/06	J	0.2	0.5	0.06	ug/L	EPA 624	1
78	3,3'-Dichlorobenzidine	11/19/03	ND	0.3	5	0.3	ug/L	EPA 625	
78	3,3'-Dichlorobenzidine	01/09/04	ND	0.3	5	0.3	ug/L	EPA 625	
78	3,3'-Dichlorobenzidine	01/04/05	ND	0.6	5	0.6	ug/L	EPA 625	4
78	3,3'-Dichlorobenzidine	01/03/06	ND	0.6	5	0.6	ug/L	EPA 625	4
79	Diethyl Phthalate	11/19/03	ND	0.7	2	0.7	ug/L	EPA 625	
79	Diethyl Phthalate	01/09/04	ND	0.7	2	0.7	ug/L	EPA 625	
79	Diethyl Phthalate	01/04/05	ND	0.9	2	0.9	ug/L	EPA 625	4
79	Diethyl Phthalate	01/03/06	ND	0.9	2	0.9	ug/L	EPA 625	4
80	Dimethyl Phthalate	11/19/03	ND	0.7	2	0.7	ug/L	EPA 625	
80	Dimethyl Phthalate	01/09/04	ND	0.7	2	0.7	ug/L	EPA 625	
80	Dimethyl Phthalate	01/04/05	ND	0.6	2	0.6	ug/L	EPA 625	4
80	Dimethyl Phthalate	01/03/06	ND	0.6	2	0.6	ug/L	EPA 625	4
81	Di-n-Butyl Phthalate	11/19/03	ND	1	5	1	ug/L	EPA 625	
81	Di-n-Butyl Phthalate	01/09/04	ND	1	5	1	ug/L	EPA 625	
81	Di-n-Butyl Phthalate	01/04/05	ND	0.6	5	0.6	ug/L	EPA 625	4
81	Di-n-Butyl Phthalate	01/03/06	ND	0.6	5	0.6	ug/L	EPA 625	4
82	2,4-Dinitrotoluene	11/19/03	ND	0.6	5	0.6	ug/L	EPA 625	
82	2,4-Dinitrotoluene	01/09/04	ND	0.6	5	0.6	ug/L	EPA 625	
82	2,4-Dinitrotoluene	01/04/05	ND	0.9	5	0.9	ug/L	EPA 625	4
82	2,4-Dinitrotoluene	01/03/06	ND	0.9	5	0.9	ug/L	EPA 625	4
83	2,6-Dinitrotoluene	11/19/03	ND	0.6	5	0.6	ug/L	EPA 625	
83	2,6-Dinitrotoluene	01/09/04	ND	0.6	5	0.6	ug/L	EPA 625	
83	2,6-Dinitrotoluene	01/04/05	ND	0.5	5	0.5	ug/L	EPA 625	4
83	2,6-Dinitrotoluene	01/03/06	ND	0.5	5	0.5	ug/L	EPA 625	4
84	Di-n-Octyl Phthalate	11/19/03	ND	0.9	5	0.9	ug/L	EPA 625	
84	Di-n-Octyl Phthalate	01/09/04	ND	0.9	5	0.9	ug/L	EPA 625	
84	Di-n-Octyl Phthalate	01/04/05	ND	0.7	5	0.7	ug/L	EPA 625	4
84	Di-n-Octyl Phthalate	01/03/06	ND	0.7	5	0.7	ug/L	EPA 625	4
85	1,2-Diphenylhydrazine	11/19/03	ND	0.6	1	0.6	ug/L	EPA 625	
85	1,2-Diphenylhydrazine	01/09/04	ND	0.6	1	0.6	ug/L	EPA 625	
85	1,2-Diphenylhydrazine	01/04/05	ND	0.9	1	0.9	ug/L	EPA 625	4
85	1,2-Diphenylhydrazine	01/03/06	ND	0.9	1	0.9	ug/L	EPA 625	4
86	Fluoranthene	11/19/03	ND	0.03	0.05	0.03	ug/L	EPA 610	
86	Fluoranthene	01/09/04	ND	0.03	0.05	0.03	ug/L	EPA 610	
86	Fluoranthene	01/04/05	ND	0.032	0.05	0.032	ug/L	EPA 610	
86	Fluoranthene	01/03/06	ND	0.03	0.05	0.03	ug/L	EPA 610	
87	Fluorene	11/19/03	ND	0.02	0.1	0.02	ug/L	EPA 610	
87	Fluorene	01/09/04	ND	0.02	0.1	0.02	ug/L	EPA 610	
87	Fluorene	01/04/05	ND	0.032	0.11	0.032	ug/L	EPA 610	
87	Fluorene	01/03/06	ND	0.03	0.1	0.03	ug/L	EPA 610	
88	Hexachlorobenzene	11/19/03	ND	0.4	1	0.4	ug/L	EPA 625	
88	Hexachlorobenzene	01/09/04	ND	0.4	1	0.4	ug/L	EPA 625	

Fact Sheet Appendix F-6(a)

City of Calistoga

CTR #	Pollutant	SAMPLE	Qualifier	RESULT	RL	MDL	UNITS	ANALYTICAL METHOD	NOTES
88	Hexachlorobenzene	01/04/05	ND	E-1 Effluent	Data	0.8	ug/L	EPA 625	4
88	Hexachlorobenzene	01/03/06	ND	0.8	1	0.8	ug/L	EPA 625	4
89	Hexachlorobutadiene	11/19/03	ND	0.7	1	0.7	ug/L	EPA 625	
89	Hexachlorobutadiene	01/09/04	ND	0.7	1	0.7	ug/L	EPA 625	
89	Hexachlorobutadiene	01/04/05	ND	0.8	1	0.8	ug/L	EPA 625	4
89	Hexachlorobutadiene	01/03/06	ND	0.8	1	0.8	ug/L	EPA 625	4
90	Hexachlorocyclopentadiene	11/19/03	ND	0.4	5	0.4	ug/L	EPA 625	
90	Hexachlorocyclopentadiene	01/09/04	ND	0.4	5	0.4	ug/L	EPA 625	
90	Hexachlorocyclopentadiene	01/04/05	ND	0.8	1	0.8	ug/L	EPA 625	4
90	Hexachlorocyclopentadiene	01/03/06	ND	0.8	1	0.8	ug/L	EPA 625	4
91	Hexachloroethane	11/19/03	ND	0.6	1	0.6	ug/L	EPA 625	
91	Hexachloroethane	01/09/04	ND	0.6	1	0.6	ug/L	EPA 625	
91	Hexachloroethane	01/04/05	ND	0.9	1	0.9	ug/L	EPA 625	4
91	Hexachloroethane	01/03/06	ND	0.9	1	0.9	ug/L	EPA 625	4
92	Indeno(1,2,3-cd)Pyrene	11/19/03	ND	0.04	0.05	0.04	ug/L	EPA 610	
92	Indeno(1,2,3-cd)Pyrene	01/09/04	ND	0.04	0.05	0.04	ug/L	EPA 610	
92	Indeno(1,2,3-cd)Pyrene	01/04/05	ND	0.032	0.05	0.032	ug/L	EPA 610	
92	Indeno(1,2,3-cd)Pyrene	01/03/06	ND	0.02	0.05	0.02	ug/L	EPA 610	
93	Isophorone	11/19/03	ND	0.8	1	0.8	ug/L	EPA 625	
93	Isophorone	01/09/04	ND	0.8	1	0.8	ug/L	EPA 625	
93	Isophorone	01/04/05	ND	0.5	1	0.5	ug/L	EPA 625	4
93	Isophorone	01/03/06	ND	0.5	1	0.5	ug/L	EPA 625	4
94	Naphthalene	11/19/03	ND	0.05	0.2	0.05	ug/L	EPA 610	
94	Naphthalene	01/09/04	ND	0.05	0.2	0.05	ug/L	EPA 610	
94	Naphthalene	01/04/05	ND	0.021	0.2	0.021	ug/L	EPA 610	
94	Naphthalene	01/03/06	ND	0.02	0.2	0.02	ug/L	EPA 610	
95	Nitrobenzene	11/19/03	ND	0.7	1	0.7	ug/L	EPA 625	
95	Nitrobenzene	01/09/04	ND	0.7	1	0.7	ug/L	EPA 625	
95	Nitrobenzene	01/04/05	ND	0.7	1	0.7	ug/L	EPA 625	4
95	Nitrobenzene	01/03/06	ND	0.7	1	0.7	ug/L	EPA 625	4
96	N-Nitrosodimethylamine	11/19/03	ND	0.6	5	0.6	ug/L	EPA 625	
96	N-Nitrosodimethylamine	01/09/04	ND	0.6	5	0.6	ug/L	EPA 625	
96	N-Nitrosodimethylamine	01/04/05	ND	0.6	5	0.6	ug/L	EPA 625	4
96	N-Nitrosodimethylamine	01/03/06	ND	0.6	5	0.6	ug/L	EPA 625	4
97	N-Nitrosodi-n-Propylamine	11/19/03	ND	0.8	5	0.8	ug/L	EPA 625	
97	N-Nitrosodi-n-Propylamine	01/09/04	ND	0.8	5	0.8	ug/L	EPA 625	
97	N-Nitrosodi-n-Propylamine	01/04/05	ND	0.8	5	0.8	ug/L	EPA 625	4
97	N-Nitrosodi-n-Propylamine	01/03/06	ND	0.8	5	0.8	ug/L	EPA 625	4
98	N-Nitrosodiphenylamine	11/19/03	ND	0.7	1	0.7	ug/L	EPA 625	
98	N-Nitrosodiphenylamine	01/09/04	ND	0.7	1	0.7	ug/L	EPA 625	
98	N-Nitrosodiphenylamine	01/04/05	ND	0.6	1	0.6	ug/L	EPA 625	4
98	N-Nitrosodiphenylamine	01/03/06	ND	0.6	1	0.6	ug/L	EPA 625	4
99	Phenanthrene	11/19/03	ND	0.03	0.05	0.03	ug/L	EPA 610	
99	Phenanthrene	01/09/04	ND	0.03	0.05	0.03	ug/L	EPA 610	
99	Phenanthrene	01/04/05	ND	0.032	0.05	0.032	ug/L	EPA 610	
99	Phenanthrene	01/03/06	ND	0.02	0.05	0.02	ug/L	EPA 610	
100	Pyrene	11/19/03	ND	0.03	0.05	0.03	ug/L	EPA 610	
100	Pyrene	01/09/04	ND	0.03	0.05	0.03	ug/L	EPA 610	
100	Pyrene	01/04/05	ND	0.032	0.05	0.032	ug/L	EPA 610	
100	Pyrene	01/03/06	ND	0.02	0.05	0.02	ug/L	EPA 610	
101	1,2,4-Trichlorobenzene	01/09/04	ND	0.6	5	0.6	ug/L	EPA 625	
101	1,2,4-Trichlorobenzene	01/04/05	ND	1.3	5	1.3	ug/L	EPA 625	4
101	1,2,4-Trichlorobenzene	01/03/06	ND	1.3	5	1.3	ug/L	EPA 625	4
102	Aldrin	01/09/04	ND	0.003	0.005	0.003	ug/L	EPA 608	
102	Aldrin	01/04/05	ND	0.003	0.005	0.003	ug/L	EPA 608	
102	Aldrin	01/03/06	ND	0.002	0.005	0.002	ug/L	EPA 200.8	
103	alpha-BHC	01/09/04	ND	0.003	0.01	0.003	ug/L	EPA 608	
103	alpha-BHC	01/04/05	ND	0.003	0.01	0.003	ug/L	EPA 608	
103	alpha-BHC	01/03/06	ND	0.003	0.01	0.003	ug/L	EPA 200.8	
104	beta-BHC	01/09/04	ND	0.004	0.005	0.004	ug/L	EPA 608	
104	beta-BHC	01/04/05	ND	0.003	0.005	0.003	ug/L	EPA 608	
104	beta-BHC	01/03/06	ND	0.003	0.005	0.003	ug/L	EPA 200.8	
105	gamma-BHC (Lindane)	01/09/04	ND	0.003	0.01	0.003	ug/L	EPA 608	
105	gamma-BHC (Lindane)	01/04/05	ND	0.003	0.01	0.003	ug/L	EPA 608	
105	gamma-BHC (Lindane)	01/03/06	ND	0.002	0.01	0.002	ug/L	EPA 200.8	
106	delta-BHC	01/09/04	ND	0.002	0.005	0.002	ug/L	EPA 608	
106	delta-BHC	01/04/05	ND	0.003	0.005	0.003	ug/L	EPA 608	
106	delta-BHC	01/03/06	ND	0.002	0.005	0.002	ug/L	EPA 200.8	
107	Chlordane	01/09/04	ND	0.005	0.02	0.005	ug/L	EPA 608	
107	Chlordane	01/04/05	ND	0.02	0.02	0.02	ug/L	EPA 608	
107	Chlordane	01/03/06	ND	0.02	0.02	0.02	ug/L	EPA 200.8	
108	4,4'-DDT	01/09/04	ND	0.003	0.01	0.003	ug/L	EPA 608	
108	4,4'-DDT	01/04/05	ND	0.003	0.01	0.003	ug/L	EPA 608	
108	4,4'-DDT	01/03/06	ND	0.002	0.01	0.002	ug/L	EPA 200.8	
109	4,4'-DDE	01/09/04	ND	0.002	0.01	0.002	ug/L	EPA 608	

Fact Sheet Appendix F-6(a)

City of Calistoga

CTR #	Pollutant	SAMPLE	Qualifier	RESULT	RL	MDL	UNITS	ANALYTICAL METHOD	NOTES
109	4,4'-DDE	01/04/05	ND	E-10 Effluent Data	0.003	0.003	ug/L	EPA 608	
109	4,4'-DDE	01/03/06	ND	0.003	0.01	0.003	ug/L	EPA 200.8	
110	4,4'-DDD	01/09/04	ND	0.002	0.01	0.002	ug/L	EPA 608	
110	4,4'-DDD	01/04/05	ND	0.002	0.01	0.002	ug/L	EPA 608	
110	4,4'-DDD	01/03/06	ND	0.002	0.01	0.002	ug/L	EPA 200.8	
111	Dieldrin	01/09/04	ND	0.002	0.01	0.002	ug/L	EPA 608	
111	Dieldrin	01/04/05	ND	0.002	0.01	0.002	ug/L	EPA 608	
111	Dieldrin	01/03/06	ND	0.002	0.01	0.002	ug/L	EPA 200.8	
112	Endosulfan I (alpha)	01/09/04	ND	0.002	0.01	0.002	ug/L	EPA 608	
112	Endosulfan I (alpha)	01/04/05	ND	0.002	0.01	0.002	ug/L	EPA 608	
112	Endosulfan I (alpha)	01/03/06	ND	0.003	0.01	0.003	ug/L	EPA 200.8	
113	Endosulfan II (beta)	01/09/04	ND	0.002	0.01	0.002	ug/L	EPA 608	
113	Endosulfan II (beta)	01/04/05	ND	0.002	0.01	0.002	ug/L	EPA 608	
113	Endosulfan II (beta)	01/03/06	ND	0.002	0.01	0.002	ug/L	EPA 200.8	
114	Endosulfan Sulfate	01/09/04	ND	0.002	0.01	0.002	ug/L	EPA 608	
114	Endosulfan Sulfate	01/04/05	ND	0.003	0.01	0.003	ug/L	EPA 608	
114	Endosulfan Sulfate	01/03/06	ND	0.002	0.01	0.002	ug/L	EPA 200.8	
115	Endrin	01/09/04	ND	0.002	0.01	0.002	ug/L	EPA 608	
115	Endrin	01/04/05	ND	0.002	0.01	0.002	ug/L	EPA 608	
115	Endrin	01/03/06	ND	0.002	0.01	0.002	ug/L	EPA 200.8	
116	Endrin Aldehyde	01/09/04	ND	0.002	0.01	0.002	ug/L	EPA 608	
116	Endrin Aldehyde	01/04/05	ND	0.003	0.01	0.003	ug/L	EPA 608	
116	Endrin Aldehyde	01/03/06	ND	0.003	0.01	0.003	ug/L	EPA 200.8	
117	Heptachlor	01/09/04	ND	0.003	0.01	0.003	ug/L	EPA 608	
117	Heptachlor	01/04/05	ND	0.003	0.01	0.003	ug/L	EPA 608	
117	Heptachlor	01/03/06	ND	0.003	0.01	0.003	ug/L	EPA 200.8	
118	Heptachlor Epoxide	01/09/04	ND	0.003	0.01	0.003	ug/L	EPA 608	
118	Heptachlor Epoxide	01/04/05	ND	0.002	0.01	0.002	ug/L	EPA 608	
118	Heptachlor Epoxide	01/03/06	ND	0.002	0.01	0.002	ug/L	EPA 200.8	
119	PCB 1016	01/09/04	ND	0.05	0.1	0.05	ug/L	EPA 608	
119	PCB 1016	01/04/05	ND	0.03	0.1	0.03	ug/L	EPA 608	
119	PCB 1016	01/03/06	ND	0.05	0.1	0.05	ug/L	EPA 200.8	
120	PCB 1221	01/09/04	ND	0.03	0.1	0.03	ug/L	EPA 608	
120	PCB 1221	01/04/05	ND	0.05	0.1	0.05	ug/L	EPA 608	
120	PCB 1221	01/03/06	ND	0.06	0.1	0.06	ug/L	EPA 200.8	
121	PCB 1232	01/09/04	ND	0.04	0.1	0.04	ug/L	EPA 608	
121	PCB 1232	01/04/05	ND	0.06	0.1	0.06	ug/L	EPA 608	
121	PCB 1232	01/03/06	ND	0.04	0.1	0.04	ug/L	EPA 200.8	
122	PCB 1242	01/09/04	ND	0.05	0.1	0.05	ug/L	EPA 608	
122	PCB 1242	01/04/05	ND	0.04	0.1	0.04	ug/L	EPA 608	
122	PCB 1242	01/03/06	ND	0.06	0.1	0.06	ug/L	EPA 200.8	
123	PCB 1248	01/09/04	ND	0.05	0.1	0.05	ug/L	EPA 608	
123	PCB 1248	01/04/05	ND	0.05	0.1	0.05	ug/L	EPA 608	
123	PCB 1248	01/03/06	ND	0.05	0.1	0.05	ug/L	EPA 200.8	
124	PCB 1254	01/09/04	ND	0.07	0.1	0.07	ug/L	EPA 608	
124	PCB 1254	01/04/05	ND	0.06	0.1	0.06	ug/L	EPA 608	
124	PCB 1254	01/03/06	ND	0.04	0.1	0.04	ug/L	EPA 200.8	
125	PCB 1260	01/09/04	ND	0.05	0.1	0.05	ug/L	EPA 608	
125	PCB 1260	01/04/05	ND	0.06	0.1	0.06	ug/L	EPA 608	
125	PCB 1260	01/03/06	ND	0.03	0.1	0.03	ug/L	EPA 200.8	
126	Toxaphene	01/09/04	ND	0.4	0.5	0.4	ug/L	EPA 608	
126	Toxaphene	01/04/05	ND	0.15	0.5	0.15	ug/L	EPA 608	
126	Toxaphene	01/03/06	ND	0.15	0.5	0.15	ug/L	EPA 200.8	
	Chlorpyrifos	01/09/04	ND	0.04	0.05	0.04	ug/L	EPA 614	
	Chlorpyrifos	01/04/05	ND	0.03	0.05	0.03	ug/L	EPA 614	
	Chlorpyrifos	01/03/06	ND	0.03	0.05	0.03	ug/L	EPA 614	
	Diazinon	01/09/04	ND	0.04	0.05	0.04	ug/L	EPA 614	
	Diazinon	01/04/05	ND	0.04	0.05	0.04	ug/L	EPA 614	
	Diazinon	01/03/06	ND	0.04	0.05	0.04	ug/L	EPA 614	
	Tributyltin	01/09/04	ND	0.000482	0.00151	0.000482	ug/L	Krone	
	Tributyltin	01/05/05	ND	0.000496	0.00155	0.000496	ug/L	Krone	
	Tributyltin	01/03/06	ND	0.00051	0.0021	0.00051	ug/L	Krone	

Fact Sheet Appendix F-6(b)

City of Calistoga
NPDES Permit Reissuance
Effluent Data E-2

CTR #	CONSTITUENT	SAMPLE DATE	SAMPLE LOCATION	RESULT	RL	MDL	UNITS	ANALYTICAL LABORATORY	ANALYTICAL METHOD	NOTES
1	Antimony	01/09/04	E-2 Effluent	= 12	0.5	0.2	ug/L	Caltest	EPA 200.8	
2	Arsenic	12/31/03	E-2 Effluent	= 10	0.5	0.2	ug/L	Caltest	EPA 200.8	
2	Arsenic	01/09/04	E-2 Effluent	= 11	0.5	0.2	ug/L	Caltest	EPA 200.8	
2	Arsenic	02/11/04	E-2 Effluent	= 12	0.5	0.2	ug/L	Caltest	EPA 200.8	
2	Arsenic	03/02/04	E-2 Effluent	= 10	0.5	0.2	ug/L	Caltest	EPA 200.8	
2	Arsenic	12/09/04	E-2 Effluent	= 16	0.5	0.14	ug/L	Caltest	EPA 200.8	
2	Arsenic	01/04/05	E-2 Effluent	= 8.4	0.5	0.14	ug/L	Caltest	EPA 200.8	
2	Arsenic	03/03/05	E-2 Effluent	= 9.7	0.5	0.14	ug/L	Caltest	EPA 200.8	
2	Arsenic	05/11/05	E-2 Effluent	= 12	1	0.28	ug/L	Caltest	EPA 200.8	
2	Arsenic	12/27/05	E-2 Effluent	= 10	0.5	0.14	ug/L	Caltest	EPA 200.8	
2	Arsenic	01/03/06	E-2 Effluent	= 7.1	0.5	0.2	ug/L	Caltest	EPA 200.8	
3	Beryllium	01/09/04	E-2 Effluent	< 0.2	0.2	0.06	ug/L	Caltest	EPA 200.8	
4	Cadmium	12/31/03	E-2 Effluent	= 0.2	0.1	0.03	ug/L	Caltest	EPA 200.8	
4	Cadmium	01/09/04	E-2 Effluent	J 0.07	0.1	0.03	ug/L	Caltest	EPA 200.8	1
4	Cadmium	02/11/04	E-2 Effluent	J 0.1	0.1	0.03	ug/L	Caltest	EPA 200.8	
4	Cadmium	03/02/04	E-2 Effluent	< 0.1	0.1	0.03	ug/L	Caltest	EPA 200.8	
4	Cadmium	12/09/04	E-2 Effluent	J 0.05	0.1	0.03	ug/L	Caltest	EPA 200.8	1
4	Cadmium	01/04/05	E-2 Effluent	< 0.1	0.1	0.03	ug/L	Caltest	EPA 200.8	
4	Cadmium	03/03/05	E-2 Effluent	J 0.03	0.1	0.03	ug/L	Caltest	EPA 200.8	
4	Cadmium	05/11/05	E-2 Effluent	J 0.05	0.1	0.03	ug/L	Caltest	EPA 200.8	
4	Cadmium	12/27/05	E-2 Effluent	< 0.1	0.1	0.03	ug/L	Caltest	EPA 200.8	
4	Cadmium	01/03/06	E-2 Effluent	< 0.1	0.1	0.04	ug/L	Caltest	EPA 200.8	
5a	Chromium (III)	12/31/03	E-2 Effluent	J 0.4	0.5	0.2	ug/L	Caltest	EPA 200.8	1
5a	Chromium (III)	01/09/04	E-2 Effluent	J 0.2	0.5	0.2	ug/L	Caltest	EPA 200.8	1
5a	Chromium (III)	02/11/04	E-2 Effluent	J 0.2	0.5	0.2	ug/L	Caltest	EPA 200.8	1
5a	Chromium (III)	03/02/04	E-2 Effluent	< 0.5	0.5	0.2	ug/L	Caltest	EPA 200.8	
5a	Chromium (III)	12/09/04	E-2 Effluent	< 0.5	0.5	0.2	ug/L	Caltest	EPA 200.8	
5a	Chromium (III)	01/04/05	E-2 Effluent	J 0.3	0.5	0.2	ug/L	Caltest	EPA 200.8	1
5a	Chromium (III)	03/03/05	E-2 Effluent	< 0.5	0.5	0.2	ug/L	Caltest	EPA 200.8	
5a	Chromium (III)	05/11/05	E-2 Effluent	< 1	1	0.4	ug/L	Caltest	EPA 200.8	
5a	Chromium (III)	12/27/05	E-2 Effluent	< 0.5	0.5	0.2	ug/L	Caltest	EPA 200.8	
5a	Chromium (III)	01/03/06	E-2 Effluent	J 0.2	0.5	0.2	ug/L	Caltest	EPA 200.8	
5b	Chromium (VI)	01/08/04	E-2 Effluent	< 10	10		ug/L	Caltest	SM3500CR	
5b	Chromium (VI)	03/03/04	E-2 Effluent	< 10	10	0.9	ug/L	Caltest	SM3500CR	
5b	Chromium (VI)	01/05/05	E-2 Effluent	< 10	10	0.5	ug/L	Caltest	SM3500CR	
6	Copper	12/31/03	E-2 Effluent	= 8.8	0.5	0.3	ug/L	Caltest	EPA 200.8	
6	Copper	01/09/04	E-2 Effluent	= 5.0	0.5	0.3	ug/L	Caltest	EPA 200.8	
6	Copper	02/11/04	E-2 Effluent	= 4.4	0.5	0.3	ug/L	Caltest	EPA 200.8	
6	Copper	03/02/04	E-2 Effluent	= 5.0	0.5	0.3	ug/L	Caltest	EPA 200.8	
6	Copper	12/09/04	E-2 Effluent	= 5.7	0.5	0.28	ug/L	Caltest	EPA 200.8	
6	Copper	01/04/05	E-2 Effluent	= 2.9	0.5	0.28	ug/L	Caltest	EPA 200.8	
6	Copper	03/03/05	E-2 Effluent	= 4.8	0.5	0.28	ug/L	Caltest	EPA 200.8	
6	Copper	05/11/05	E-2 Effluent	= 8.1	1	0.56	ug/L	Caltest	EPA 200.8	
6	Copper	12/27/05	E-2 Effluent	= 3.4	0.5	0.28	ug/L	Caltest	EPA 200.8	
6	Copper	01/03/06	E-2 Effluent	= 2.5	0.5	0.08	ug/L	Caltest	EPA 200.8	
7	Lead	12/31/03	E-2 Effluent	= 0.55	0.25	0.04	ug/L	Caltest	EPA 200.8	
7	Lead	01/09/04	E-2 Effluent	= 0.76	0.25	0.04	ug/L	Caltest	EPA 200.8	
7	Lead	02/11/04	E-2 Effluent	= 0.98	0.25	0.04	ug/L	Caltest	EPA 200.8	
7	Lead	03/02/04	E-2 Effluent	J 0.24	0.25	0.04	ug/L	Caltest	EPA 200.8	1
7	Lead	12/09/04	E-2 Effluent	J 0.2	0.25	0.04	ug/L	Caltest	EPA 200.8	1
7	Lead	01/04/05	E-2 Effluent	J 0.11	0.25	0.04	ug/L	Caltest	EPA 200.8	1
7	Lead	03/03/05	E-2 Effluent	J 0.23	0.25	0.04	ug/L	Caltest	EPA 200.8	
7	Lead	05/11/05	E-2 Effluent	J 0.24	0.25	0.04	ug/L	Caltest	EPA 200.8	
7	Lead	12/27/05	E-2 Effluent	J 0.16	0.25	0.04	ug/L	Caltest	EPA 200.8	
7	Lead	01/03/06	E-2 Effluent	J 0.15	0.25	0.07	ug/L	Caltest	EPA 200.8	
8	Mercury	12/31/03	E-2 Effluent	= 0.0068	0.0005	0.00024	ug/L	Caltest	EPA 1631	
8	Mercury	01/09/04	E-2 Effluent	= 0.0042	0.0005	0.00024	ug/L	Caltest	EPA 1631	
8	Mercury	02/11/04	E-2 Effluent	= 0.0042	0.0005	0.00024	ug/L	Caltest	EPA 1631	
8	Mercury	03/03/04	E-2 Effluent	= 0.0043	0.0005	0.00024	ug/L	Caltest	EPA 1631	
8	Mercury	12/09/04	E-2 Effluent	= 0.0052	0.0005	0.00024	ug/L	Caltest	EPA 1631	
8	Mercury	01/04/05	E-2 Effluent	= 0.0074	0.0005	0.00024	ug/L	Caltest	EPA 1631	
8	Mercury	03/04/05	E-2 Effluent	= 0.0042	0.0005	0.00024	ug/L	Caltest	EPA 1631	
8	Mercury	05/12/05	E-2 Effluent	= 0.0044	0.0005	0.0002	ug/L	Caltest	EPA 1631	
8	Mercury	12/28/05	E-2 Effluent	= 0.0059	0.0005	0.0002	ug/L	Caltest	EPA 1631	
8	Mercury	01/03/06	E-2 Effluent	= 0.0044	0.0005	0.0002	ug/L	Caltest	EPA 1631	
9	Nickel	03/03/05	E-2 Effluent	= 1.5	0.5	0.14	ug/L	Caltest	EPA 200.8	
9	Nickel	05/11/05	E-2 Effluent	= 2.4	1	0.28	ug/L	Caltest	EPA 200.8	
9	Nickel	12/27/05	E-2 Effluent	= 1.1	0.5	0.14	ug/L	Caltest	EPA 200.8	
9	Nickel	12/31/03	E-2 Effluent	= 2.1	0.5	0.2	ug/L	Caltest	EPA 200.8	

Fact Sheet Appendix F-6(b)

City of Calistoga
NPDES Permit Reissuance
Effluent Data E-2

CTR #	CONSTITUENT	SAMPLE DATE	SAMPLE LOCATION	RESULT	RL	MDL	UNITS	ANALYTICAL LABORATORY	ANALYTICAL METHOD	NOTES
9	Nickel	01/09/04	E-2 Effluent	= 1.6	0.5	0.2	ug/L	Caltest	EPA 200.8	
9	Nickel	02/11/04	E-2 Effluent	= 1.3	0.5	0.2	ug/L	Caltest	EPA 200.8	
9	Nickel	03/02/04	E-2 Effluent	= 1.6	0.5	0.2	ug/L	Caltest	EPA 200.8	
9	Nickel	12/09/04	E-2 Effluent	= 1.5	0.5	0.14	ug/L	Caltest	EPA 200.8	
9	Nickel	01/04/05	E-2 Effluent	= 1.4	0.5	0.14	ug/L	Caltest	EPA 200.8	
9	Nickel	01/03/06	E-2 Effluent	= 1.3	0.5	0.2	ug/L	Caltest	EPA 200.8	
10	Selenium	03/03/05	E-2 Effluent	< 4	4	2	ug/L	Caltest	EPA 200.8	2
10	Selenium	05/11/05	E-2 Effluent	< 2	2	1	ug/L	Caltest	EPA 200.8	2
10	Selenium	12/27/05	E-2 Effluent	< 2	2	1.4	ug/L	Caltest	EPA 200.8	2
10	Selenium	12/31/03	E-2 Effluent	< 3	3	0.5	ug/L	Caltest	EPA 200.8	2
10	Selenium	01/09/04	E-2 Effluent	< 1	1	0.5	ug/L	Caltest	EPA 200.8	
10	Selenium	02/11/04	E-2 Effluent	< 1	1	0.5	ug/L	Caltest	EPA 200.8	2
10	Selenium	03/02/04	E-2 Effluent	< 1	1	0.5	ug/L	Caltest	EPA 200.8	
10	Selenium	12/09/04	E-2 Effluent	< 5	5	2.5	ug/L	Caltest	EPA 200.8	2
10	Selenium	01/04/05	E-2 Effluent	< 2	2	1.2	ug/L	Caltest	EPA 200.8	2
10	Selenium	01/03/06	E-2 Effluent	< 1	1	0.7	ug/L	Caltest	EPA 200.8	
11	Silver	03/03/05	E-2 Effluent	< 0.1	0.1	0.03	ug/L	Caltest	EPA 200.8	
11	Silver	05/11/05	E-2 Effluent	J 0.03	0.1	0.03	ug/L	Caltest	EPA 200.8	
11	Silver	12/27/05	E-2 Effluent	< 0.1	0.1	0.03	ug/L	Caltest	EPA 200.8	
11	Silver	12/31/03	E-2 Effluent	= 0.2	0.1	0.02	ug/L	Caltest	EPA 200.8	
11	Silver	01/09/04	E-2 Effluent	J 0.03	0.1	0.02	ug/L	Caltest	EPA 200.8	1
11	Silver	02/11/04	E-2 Effluent	J 0.02	0.1	0.02	ug/L	Caltest	EPA 200.8	1
11	Silver	03/02/04	E-2 Effluent	J 0.03	0.1	0.02	ug/L	Caltest	EPA 200.8	1
11	Silver	12/09/04	E-2 Effluent	J 0.03	0.1	0.03	ug/L	Caltest	EPA 200.8	1
11	Silver	01/04/05	E-2 Effluent	< 0.1	0.1	0.03	ug/L	Caltest	EPA 200.8	
11	Silver	01/03/06	E-2 Effluent	< 0.1	0.1	0.02	ug/L	Caltest	EPA 200.8	
12	Thallium	01/09/04	E-2 Effluent	J 0.04	0.1	0.03	ug/L	Caltest	EPA 200.8	1
13	Zinc	12/31/03	E-2 Effluent	= 25	1	0.3	ug/L	Caltest	EPA 200.8	
13	Zinc	01/09/04	E-2 Effluent	= 35	2	0.3	ug/L	Caltest	EPA 200.8	
13	Zinc	02/11/04	E-2 Effluent	= 44	2	0.3	ug/L	Caltest	EPA 200.8	
13	Zinc	03/02/04	E-2 Effluent	= 24	2	0.3	ug/L	Caltest	EPA 200.8	
13	Zinc	12/09/04	E-2 Effluent	= 33	1	0.3	ug/L	Caltest	EPA 200.8	
13	Zinc	01/04/05	E-2 Effluent	= 10	1	0.3	ug/L	Caltest	EPA 200.8	
13	Zinc	03/03/05	E-2 Effluent	= 30	1	0.3	ug/L	Caltest	EPA 200.8	
13	Zinc	05/11/05	E-2 Effluent	= 37	2	0.6	ug/L	Caltest	EPA 200.8	
13	Zinc	12/27/05	E-2 Effluent	= 16	1	0.3	ug/L	Caltest	EPA 200.8	
13	Zinc	01/03/06	E-2 Effluent	= 8	1	0.8	ug/L	Caltest	EPA 200.8	
14	Cyanide	03/03/05	E-2 Effluent	= 3.3	3	0.8	ug/L	Caltest	EPA 335.2	
14	Cyanide	05/11/05	E-2 Effluent	= 9.2	3	0.8	ug/L	Caltest	EPA 335.2	
14	Cyanide	12/27/05	E-2 Effluent	= 3	3	0.8	ug/L	Caltest	EPA 335.2	
14	Cyanide	12/30/03	E-2 Effluent	J 1.1	3	0.9	ug/L	Caltest	EPA 335.2	1
14	Cyanide	01/09/04	E-2 Effluent	< 3	3	0.9	ug/L	Caltest	EPA 335.2	
14	Cyanide	02/10/04	E-2 Effluent	J 2.8	3	0.9	ug/L	Caltest	EPA 335.2	1
14	Cyanide	03/02/04	E-2 Effluent	= 4	3	0.9	ug/L	Caltest	EPA 335.2	
14	Cyanide	12/09/04	E-2 Effluent	< 3	3		ug/L	Caltest	EPA 335.2	
14	Cyanide	01/04/05	E-2 Effluent	= 4	3	0.8	ug/L	Caltest	EPA 335.2	
14	Cyanide	01/03/06	E-2 Effluent	= 3.1	3	0.8	ug/L	Caltest	EPA 335.2	
16	2,3,7,8-TCDD (Dioxin)	01/09/04	E-2 Effluent	< 1.69	1.69	0.637	pg/L	Alta	EPA 1613	
16	2,3,7,8-TCDD (Dioxin)	01/05/05	E-2 Effluent	< 0.369	0.369	0.699	pg/L	Alta	EPA 1613	
16	2,3,7,8-TCDD (Dioxin)	01/03/06	E-2 Effluent				pg/L	Alta	EPA 1613	
17	Acrolein	01/09/04	E-2 Effluent	< 5	5	1	ug/L	Caltest	EPA 624	
17	Acrolein	01/04/05	E-2 Effluent	< 5	5	0.56	ug/L	Caltest	EPA 624	5
17	Acrolein	01/03/06	E-2 Effluent	< 5	5	0.56	ug/L	Caltest	EPA 624	6
18	Acrylonitrile	01/09/04	E-2 Effluent	< 2	2	1	ug/L	Caltest	EPA 624	
18	Acrylonitrile	01/04/05	E-2 Effluent	< 2	2	0.33	ug/L	Caltest	EPA 624	
18	Acrylonitrile	01/03/06	E-2 Effluent	< 2	2	0.33	ug/L	Caltest	EPA 624	
19	Benzene	01/09/04	E-2 Effluent	< 0.5	0.5	0.3	ug/L	Caltest	EPA 624	
19	Benzene	01/04/05	E-2 Effluent	< 0.5	0.5	0.06	ug/L	Caltest	EPA 624	
19	Benzene	01/03/06	E-2 Effluent	< 0.5	0.5	0.06	ug/L	Caltest	EPA 624	
20	Bromoform	01/09/04	E-2 Effluent	J 0.4	0.5	0.2	ug/L	Caltest	EPA 624	1
20	Bromoform	01/04/05	E-2 Effluent	J 0.4	0.5	0.07	ug/L	Caltest	EPA 624	1
20	Bromoform	01/03/06	E-2 Effluent	J 0.3	0.5	0.07	ug/L	Caltest	EPA 624	
21	Carbon Tetrachloride	01/04/05	E-2 Effluent	< 0.5	0.5	0.06	ug/L	Caltest	EPA 624	
21	Carbon Tetrachloride	01/03/06	E-2 Effluent	J 0.09	0.5	0.06	ug/L	Caltest	EPA 624	
21	Carbon Tetrachloride	01/09/04	E-2 Effluent	< 0.5	0.5	0.42	ug/L	Caltest	EPA 624	
22	Chlorobenzene	01/09/04	E-2 Effluent	< 0.5	0.5	0.3	ug/L	Caltest	EPA 624	
22	Chlorobenzene	01/04/05	E-2 Effluent	< 0.5	0.5	0.06	ug/L	Caltest	EPA 624	
22	Chlorobenzene	01/03/06	E-2 Effluent	< 0.5	0.5	0.06	ug/L	Caltest	EPA 624	

Fact Sheet Appendix F-6(b)

City of Calistoga
 NPDES Permit Reissuance
 Effluent Data E-2

CTR #	CONSTITUENT	SAMPLE DATE	SAMPLE LOCATION	RESULT	RL	MDL	UNITS	ANALYTICAL LABORATORY	ANALYTICAL METHOD	NOTES
23	Chlorodibromomethane	01/09/04	E-2 Effluent	= 4.5	0.5	0.3	ug/L	Caltest	EPA 624	
23	Chlorodibromomethane	01/04/05	E-2 Effluent	= 4.9	0.5	0.07	ug/L	Caltest	EPA 624	
23	Chlorodibromomethane	01/03/06	E-2 Effluent	= 2.1	0.5	0.07	ug/L	Caltest	EPA 624	
24	Chloroethane	01/09/04	E-2 Effluent	< 0.5	0.5	0.34	ug/L	Caltest	EPA 624	
24	Chloroethane	01/04/05	E-2 Effluent	< 0.5	0.5	0.07	ug/L	Caltest	EPA 624	
24	Chloroethane	01/03/06	E-2 Effluent	< 0.5	0.5	0.07	ug/L	Caltest	EPA 624	
25	2-Chloroethylvinyl Ether	01/09/04	E-2 Effluent	< 1	1	0.32	ug/L	Caltest	EPA 624	
25	2-Chloroethylvinyl Ether	01/04/05	E-2 Effluent	< 1	1	0.1	ug/L	Caltest	EPA 624	
25	2-Chloroethylvinyl Ether	01/03/06	E-2 Effluent	< 1	1	0.1	ug/L	Caltest	EPA 624	7
26	Chloroform	01/09/04	E-2 Effluent	= 23	0.5	0.31	ug/L	Caltest	EPA 624	
26	Chloroform	01/04/05	E-2 Effluent	= 20	0.5	0.05	ug/L	Caltest	EPA 624	
26	Chloroform	01/03/06	E-2 Effluent	= 9.8	0.5	0.05	ug/L	Caltest	EPA 624	
27	Dichlorobromomethane	01/09/04	E-2 Effluent	= 12	0.5	0.2	ug/L	Caltest	EPA 624	
27	Dichlorobromomethane	01/04/05	E-2 Effluent	= 13	0.5	0.06	ug/L	Caltest	EPA 624	
27	Dichlorobromomethane	01/03/06	E-2 Effluent	= 6.5	0.5	0.06	ug/L	Caltest	EPA 624	
28	1,1-Dichloroethane	01/09/04	E-2 Effluent	< 0.5	0.5	0.34	ug/L	Caltest	EPA 624	
28	1,1-Dichloroethane	01/04/05	E-2 Effluent	< 0.5	0.5	0.05	ug/L	Caltest	EPA 624	
28	1,1-Dichloroethane	01/03/06	E-2 Effluent	< 0.5	0.5	0.05	ug/L	Caltest	EPA 624	
29	1,2-Dichloroethane	01/09/04	E-2 Effluent	< 0.5	0.5	0.2	ug/L	Caltest	EPA 624	
29	1,2-Dichloroethane	01/04/05	E-2 Effluent	< 0.5	0.5	0.06	ug/L	Caltest	EPA 624	
29	1,2-Dichloroethane	01/03/06	E-2 Effluent	< 0.5	0.5	0.06	ug/L	Caltest	EPA 624	
30	1,1-Dichloroethene	01/09/04	E-2 Effluent	< 0.5	0.5	0.49	ug/L	Caltest	EPA 624	
30	1,1-Dichloroethene	01/04/05	E-2 Effluent	< 0.5	0.5	0.06	ug/L	Caltest	EPA 624	
30	1,1-Dichloroethene	01/03/06	E-2 Effluent	< 0.5	0.5	0.07	ug/L	Caltest	EPA 624	
31	1,2-Dichloropropane	01/09/04	E-2 Effluent	< 0.5	0.5	0.2	ug/L	Caltest	EPA 624	
31	1,2-Dichloropropane	01/04/05	E-2 Effluent	< 0.5	0.5	0.05	ug/L	Caltest	EPA 624	
31	1,2-Dichloropropane	01/03/06	E-2 Effluent	< 0.5	0.5	0.05	ug/L	Caltest	EPA 624	
32	cis-1,3-Dichloropropene	01/09/04	E-2 Effluent	< 0.5	0.5	0.2	ug/L	Caltest	EPA 624	
32	cis-1,3-Dichloropropene	01/04/05	E-2 Effluent	< 0.5	0.5	0.06	ug/L	Caltest	EPA 624	
32	cis-1,3-Dichloropropene	01/03/06	E-2 Effluent	< 0.5	0.5	0.06	ug/L	Caltest	EPA 624	
32	trans-1,3-Dichloropropene	01/09/04	E-2 Effluent	< 0.5	0.5	0.3	ug/L	Caltest	EPA 624	
32	trans-1,3-Dichloropropene	01/04/05	E-2 Effluent	< 0.5	0.5	0.06	ug/L	Caltest	EPA 624	
32	trans-1,3-Dichloropropene	01/03/06	E-2 Effluent	< 0.5	0.5	0.05	ug/L	Caltest	EPA 624	
33	Ethylbenzene	01/09/04	E-2 Effluent	< 0.5	0.5	0.4	ug/L	Caltest	EPA 624	
33	Ethylbenzene	01/04/05	E-2 Effluent	< 0.5	0.5	0.06	ug/L	Caltest	EPA 624	
33	Ethylbenzene	01/03/06	E-2 Effluent	< 0.5	0.5	0.06	ug/L	Caltest	EPA 624	
34	Methyl Bromide	01/09/04	E-2 Effluent	= 0.6	0.5	0.42	ug/L	Caltest	EPA 624	
34	Methyl Bromide	01/04/05	E-2 Effluent	< 0.5	0.5	0.05	ug/L	Caltest	EPA 624	
34	Methyl Bromide	01/03/06	E-2 Effluent	J 0.4	0.5	0.05	ug/L	Caltest	EPA 624	3
35	Methyl Chloride	01/09/04	E-2 Effluent	= 1.4	0.5	0.46	ug/L	Caltest	EPA 624	
35	Methyl Chloride	01/04/05	E-2 Effluent	< 0.5	0.5	0.04	ug/L	Caltest	EPA 624	
35	Methyl Chloride	01/03/06	E-2 Effluent	J 0.26	0.5	0.04	ug/L	Caltest	EPA 624	3
36	Methylene Chloride	01/09/04	E-2 Effluent	= 0.5	0.5	0.4	ug/L	Caltest	EPA 624	
36	Methylene Chloride	01/04/05	E-2 Effluent	< 0.5	0.5	0.07	ug/L	Caltest	EPA 624	
36	Methylene Chloride	01/03/06	E-2 Effluent	J 0.17	0.5	0.07	ug/L	Caltest	EPA 624	3
37	1,1,2,2-Tetrachloroethane	01/09/04	E-2 Effluent	< 0.5	0.5	0.3	ug/L	Caltest	EPA 624	
37	1,1,2,2-Tetrachloroethane	01/04/05	E-2 Effluent	< 0.5	0.5	0.06	ug/L	Caltest	EPA 624	
37	1,1,2,2-Tetrachloroethane	01/03/06	E-2 Effluent	< 0.5	0.5	0.06	ug/L	Caltest	EPA 624	
38	Tetrachloroethylene	01/09/04	E-2 Effluent	< 0.5	0.5	0.44	ug/L	Caltest	EPA 624	
38	Tetrachloroethylene	01/04/05	E-2 Effluent	< 0.5	0.5	0.06	ug/L	Caltest	EPA 624	
38	Tetrachloroethylene	01/03/06	E-2 Effluent	< 0.5	0.5	0.06	ug/L	Caltest	EPA 624	
39	Toluene	01/09/04	E-2 Effluent	< 0.5	0.5	0.32	ug/L	Caltest	EPA 624	
39	Toluene	01/04/05	E-2 Effluent	J 0.1	0.5	0.06	ug/L	Caltest	EPA 624	1
39	Toluene	01/03/06	E-2 Effluent	< 0.5	0.5	0.06	ug/L	Caltest	EPA 624	
40	1,2-trans-Dichloroethylene	01/09/04	E-2 Effluent	< 0.5	0.5	0.43	ug/L	Caltest	EPA 624	
40	1,2-trans-Dichloroethylene	01/04/05	E-2 Effluent	< 0.5	0.5	0.05	ug/L	Caltest	EPA 624	
40	1,2-trans-Dichloroethylene	01/03/06	E-2 Effluent	< 0.5	0.5	0.05	ug/L	Caltest	EPA 624	
41	1,1,1-Trichloroethane	01/09/04	E-2 Effluent	< 0.5	0.5	0.49	ug/L	Caltest	EPA 624	
41	1,1,1-Trichloroethane	01/04/05	E-2 Effluent	< 0.5	0.5	0.06	ug/L	Caltest	EPA 624	
41	1,1,1-Trichloroethane	01/03/06	E-2 Effluent	< 0.5	0.5	0.06	ug/L	Caltest	EPA 624	
42	1,1,2-Trichloroethane	01/09/04	E-2 Effluent	< 0.5	0.5	0.3	ug/L	Caltest	EPA 624	
42	1,1,2-Trichloroethane	01/04/05	E-2 Effluent	< 0.5	0.5	0.07	ug/L	Caltest	EPA 624	
42	1,1,2-Trichloroethane	01/03/06	E-2 Effluent	< 0.5	0.5	0.07	ug/L	Caltest	EPA 624	
43	Trichloroethene	01/09/04	E-2 Effluent	< 0.5	0.5	0.3	ug/L	Caltest	EPA 624	

Fact Sheet Appendix F-6(b)

City of Calistoga
 NPDES Permit Reissuance
 Effluent Data E-2

CTR #	CONSTITUENT	SAMPLE DATE	SAMPLE LOCATION	RESULT	RL	MDL	UNITS	ANALYTICAL LABORATORY	ANALYTICAL METHOD	NOTES
43	Trichloroethene	01/04/05	E-2 Effluent	< 0.5	0.5	0.06	ug/L	Caltest	EPA 624	
43	Trichloroethene	01/03/06	E-2 Effluent	< 0.5	0.5	0.06	ug/L	Caltest	EPA 624	
44	Vinyl Chloride	01/09/04	E-2 Effluent	< 0.5	0.5	0.47	ug/L	Caltest	EPA 624	
44	Vinyl Chloride	01/04/05	E-2 Effluent	< 0.5	0.5	0.05	ug/L	Caltest	EPA 624	
44	Vinyl Chloride	01/03/06	E-2 Effluent	< 0.5	0.5	0.05	ug/L	Caltest	EPA 624	
45	2-Chlorophenol	01/09/04	E-2 Effluent	< 2	2	0.6	ug/L	Caltest	EPA 625	
45	2-Chlorophenol	01/05/05	E-2 Effluent	< 2	2	1.2	ug/L	Caltest	EPA 625	4
45	2-Chlorophenol	01/03/06	E-2 Effluent	< 2	2	1.2	ug/L	Caltest	EPA 625	
46	2,4-Dichlorophenol	01/09/04	E-2 Effluent	< 1	1	0.7	ug/L	Caltest	EPA 625	
46	2,4-Dichlorophenol	01/05/05	E-2 Effluent	< 1	1	0.9	ug/L	Caltest	EPA 625	4
46	2,4-Dichlorophenol	01/03/06	E-2 Effluent	< 1	1	0.9	ug/L	Caltest	EPA 625	
47	2,4-Dimethylphenol	01/09/04	E-2 Effluent	< 2	2	0.9	ug/L	Caltest	EPA 625	
47	2,4-Dimethylphenol	01/05/05	E-2 Effluent	< 2	2	1.1	ug/L	Caltest	EPA 625	4
47	2,4-Dimethylphenol	01/03/06	E-2 Effluent	< 2	2	1.1	ug/L	Caltest	EPA 625	
48	2-Methyl-4,6-Dinitrophenol	01/09/04	E-2 Effluent	< 5	5	0.9	ug/L	Caltest	EPA 625	
48	2-Methyl-4,6-Dinitrophenol	01/05/05	E-2 Effluent	< 5	5	2	ug/L	Caltest	EPA 625	4
48	2-Methyl-4,6-Dinitrophenol	01/03/06	E-2 Effluent	< 5	5	2	ug/L	Caltest	EPA 625	
49	2,4-Dinitrophenol	01/09/04	E-2 Effluent	< 5	5	0.6	ug/L	Caltest	EPA 625	
49	2,4-Dinitrophenol	01/05/05	E-2 Effluent	< 5	5	2	ug/L	Caltest	EPA 625	4
49	2,4-Dinitrophenol	01/03/06	E-2 Effluent	< 5	5	2	ug/L	Caltest	EPA 625	
50	2-Nitrophenol	01/09/04	E-2 Effluent	< 5	5	0.7	ug/L	Caltest	EPA 625	
50	2-Nitrophenol	01/05/05	E-2 Effluent	< 5	5	1.1	ug/L	Caltest	EPA 625	4
50	2-Nitrophenol	01/03/06	E-2 Effluent	< 5	5	1.1	ug/L	Caltest	EPA 625	
51	4-Nitrophenol	01/09/04	E-2 Effluent	< 5	5	0.6	ug/L	Caltest	EPA 625	
51	4-Nitrophenol	01/05/05	E-2 Effluent	< 5	5	1	ug/L	Caltest	EPA 625	4
51	4-Nitrophenol	01/03/06	E-2 Effluent	< 5	5	1	ug/L	Caltest	EPA 625	
52	4-Chloro-3-Methylphenol	01/09/04	E-2 Effluent	< 1	1	0.5	ug/L	Caltest	EPA 625	
52	4-Chloro-3-Methylphenol	01/05/05	E-2 Effluent	< 1	1	0.93	ug/L	Caltest	EPA 625	4
52	4-Chloro-3-Methylphenol	01/03/06	E-2 Effluent	< 1	1	0.93	ug/L	Caltest	EPA 625	
53	Pentachlorophenol	01/09/04	E-2 Effluent	< 1	1	0.9	ug/L	Caltest	EPA 625	
53	Pentachlorophenol	01/05/05	E-2 Effluent	< 1	1	0.98	ug/L	Caltest	EPA 625	4
53	Pentachlorophenol	01/03/06	E-2 Effluent	< 1	1	0.98	ug/L	Caltest	EPA 625	
54	Phenol	01/09/04	E-2 Effluent	< 1	1	0.4	ug/L	Caltest	EPA 625	
54	Phenol	01/05/05	E-2 Effluent	< 1	1	0.8	ug/L	Caltest	EPA 625	4
54	Phenol	01/03/06	E-2 Effluent	< 1	1	0.8	ug/L	Caltest	EPA 625	
55	2,4,6-Trichlorophenol	01/09/04	E-2 Effluent	< 5	5	0.6	ug/L	Caltest	EPA 625	
55	2,4,6-Trichlorophenol	01/05/05	E-2 Effluent	< 5	5	2	ug/L	Caltest	EPA 625	4
55	2,4,6-Trichlorophenol	01/03/06	E-2 Effluent	< 5	5	2	ug/L	Caltest	EPA 625	
56	Acenaphthene	12/31/03	E-2 Effluent	< 0.3	0.3	0.17	ug/L	Caltest	EPA 610	
56	Acenaphthene	01/09/04	E-2 Effluent	< 0.3	0.3	0.17	ug/L	Caltest	EPA 610	
56	Acenaphthene	01/05/05	E-2 Effluent	< 0.33	0.33	0.033	ug/L	Caltest	EPA 610	
56	Acenaphthene	01/03/06	E-2 Effluent	< 0.3	0.3	0.03	ug/L	Caltest	EPA 610	
57	Acenaphthylene	12/31/03	E-2 Effluent	< 0.2	0.2	0.03	ug/L	Caltest	EPA 610	
57	Acenaphthylene	01/09/04	E-2 Effluent	< 0.2	0.2	0.03	ug/L	Caltest	EPA 610	
57	Acenaphthylene	01/05/05	E-2 Effluent	< 0.22	0.22	0.022	ug/L	Caltest	EPA 610	
57	Acenaphthylene	01/03/06	E-2 Effluent	< 0.2	0.2	0.02	ug/L	Caltest	EPA 610	
58	Anthracene	12/31/03	E-2 Effluent	< 0.3	0.3	0.16	ug/L	Caltest	EPA 610	
58	Anthracene	01/09/04	E-2 Effluent	< 0.3	0.3	0.16	ug/L	Caltest	EPA 610	
58	Anthracene	01/05/05	E-2 Effluent	< 0.33	0.33	0.033	ug/L	Caltest	EPA 610	
58	Anthracene	01/03/06	E-2 Effluent	< 0.3	0.3	0.03	ug/L	Caltest	EPA 610	
59	Benzidine	01/09/04	E-2 Effluent	< 5	5	1	ug/L	Caltest	EPA 625	
59	Benzidine	01/05/05	E-2 Effluent	< 5	5	1	ug/L	Caltest	EPA 625	4
59	Benzidine	01/03/06	E-2 Effluent	< 5	5	1	ug/L	Caltest	EPA 625	
60	Benzo(a)Anthracene	12/31/03	E-2 Effluent	< 0.3	0.3	0.12	ug/L	Caltest	EPA 610	
60	Benzo(a)Anthracene	01/09/04	E-2 Effluent	< 0.3	0.3	0.12	ug/L	Caltest	EPA 610	
60	Benzo(a)anthracene	02/11/04	E-2 Effluent	< 0.3	0.3	0.12	ug/L	Caltest	EPA 610	
60	Benzo(a)Anthracene	01/05/05	E-2 Effluent	< 0.33	0.33	0.022	ug/L	Caltest	EPA 610	
60	Benzo(a)Anthracene	01/03/06	E-2 Effluent	< 0.3	0.3	0.02	ug/L	Caltest	EPA 610	
61	Benzo(a)Pyrene	12/31/03	E-2 Effluent	< 0.3	0.3	0.09	ug/L	Caltest	EPA 610	
61	Benzo(a)Pyrene	01/09/04	E-2 Effluent	< 0.3	0.3	0.09	ug/L	Caltest	EPA 610	
61	Benzo(a)Pyrene	01/05/05	E-2 Effluent	< 0.33	0.33	0.022	ug/L	Caltest	EPA 610	
61	Benzo(a)Pyrene	01/03/06	E-2 Effluent	< 0.3	0.3	0.02	ug/L	Caltest	EPA 610	
62	Benzo(b)Fluoranthene	12/31/03	E-2 Effluent	< 0.3	0.3	0.11	ug/L	Caltest	EPA 610	
62	Benzo(b)Fluoranthene	01/09/04	E-2 Effluent	< 0.3	0.3	0.11	ug/L	Caltest	EPA 610	
62	Benzo(b)Fluoranthene	01/05/05	E-2 Effluent	< 0.33	0.33	0.033	ug/L	Caltest	EPA 610	

Fact Sheet Appendix F-6(b)

City of Calistoga
NPDES Permit Reissuance
Effluent Data E-2

CTR #	CONSTITUENT	SAMPLE DATE	SAMPLE LOCATION	RESULT	RL	MDL	UNITS	ANALYTICAL LABORATORY	ANALYTICAL METHOD	NOTES
62	Benzo(b)Fluoranthene	01/03/06	E-2 Effluent	< 0.3	0.3	0.02	ug/L	Caltest	EPA 610	
63	Benzo(ghi)Perylene	12/31/03	E-2 Effluent	< 0.1	0.1	0.06	ug/L	Caltest	EPA 610	
63	Benzo(ghi)Perylene	01/09/04	E-2 Effluent	< 0.1	0.1	0.06	ug/L	Caltest	EPA 610	
63	Benzo(ghi)Perylene	01/05/05	E-2 Effluent	< 0.11	0.11	0.033	ug/L	Caltest	EPA 610	
63	Benzo(ghi)Perylene	01/03/06	E-2 Effluent	< 0.1	0.1	0.02	ug/L	Caltest	EPA 610	
64	Benzo(k)Fluoranthene	12/31/03	E-2 Effluent	< 0.3	0.3	0.16	ug/L	Caltest	EPA 610	
64	Benzo(k)Fluoranthene	01/09/04	E-2 Effluent	< 0.3	0.3	0.16	ug/L	Caltest	EPA 610	
64	Benzo(k)Fluoranthene	01/05/05	E-2 Effluent	< 0.33	0.33	0.044	ug/L	Caltest	EPA 610	
64	Benzo(k)Fluoranthene	01/03/06	E-2 Effluent	< 0.3	0.3	0.02	ug/L	Caltest	EPA 610	
65	Bis(2-Chloroethoxy)Methane	01/09/04	E-2 Effluent	< 5	5	0.9	ug/L	Caltest	EPA 625	
65	Bis(2-Chloroethoxy)Methane	01/05/05	E-2 Effluent	< 5	5	0.8	ug/L	Caltest	EPA 625	4
65	Bis(2-Chloroethoxy)Methane	01/03/06	E-2 Effluent	< 5	5	0.8	ug/L	Caltest	EPA 625	
66	Bis(2-Chloroethyl)Ether	01/09/04	E-2 Effluent	< 1	1	0.7	ug/L	Caltest	EPA 625	
66	Bis(2-Chloroethyl)Ether	01/05/05	E-2 Effluent	< 1	1	0.7	ug/L	Caltest	EPA 625	4
66	Bis(2-Chloroethyl)Ether	01/03/06	E-2 Effluent	< 1	1	0.7	ug/L	Caltest	EPA 625	
67	Bis(2-Chloroisopropyl)Ether	01/09/04	E-2 Effluent	< 2	2	0.6	ug/L	Caltest	EPA 625	
67	Bis(2-Chloroisopropyl)Ether	01/05/05	E-2 Effluent	< 2	2	0.7	ug/L	Caltest	EPA 625	4
67	Bis(2-Chloroisopropyl)Ether	01/03/06	E-2 Effluent	< 2	2	0.7	ug/L	Caltest	EPA 625	
68	Bis(2-Ethylhexyl)Phthalate	01/09/04	E-2 Effluent	< 5	5	0.8	ug/L	Caltest	EPA 625	
68	Bis(2-Ethylhexyl)Phthalate	01/05/05	E-2 Effluent	< 3	3	0.5	ug/L	Caltest	EPA 625	4
68	Bis(2-Ethylhexyl)Phthalate	01/03/06	E-2 Effluent	< 3	3	0.5	ug/L	Caltest	EPA 625	
69	4-Bromophenyl Phenyl Ether	01/09/04	E-2 Effluent	< 5	5	0.4	ug/L	Caltest	EPA 625	
69	4-Bromophenyl Phenyl Ether	01/05/05	E-2 Effluent	< 5	5	2	ug/L	Caltest	EPA 625	4
69	4-Bromophenyl Phenyl Ether	01/03/06	E-2 Effluent	< 5	5	2	ug/L	Caltest	EPA 625	
70	Butylbenzyl Phthalate	01/09/04	E-2 Effluent	< 5	5	0.8	ug/L	Caltest	EPA 625	
70	Butylbenzyl Phthalate	01/05/05	E-2 Effluent	< 5	5	2	ug/L	Caltest	EPA 625	4
70	Butylbenzyl Phthalate	01/03/06	E-2 Effluent	< 5	5	2	ug/L	Caltest	EPA 625	
71	2-Chloronaphthalene	01/09/04	E-2 Effluent	< 5	5	0.5	ug/L	Caltest	EPA 625	
71	2-Chloronaphthalene	01/05/05	E-2 Effluent	< 5	5	0.6	ug/L	Caltest	EPA 625	4
71	2-Chloronaphthalene	01/03/06	E-2 Effluent	< 5	5	0.6	ug/L	Caltest	EPA 625	
72	4-Chlorophenyl Phenyl Ether	01/09/04	E-2 Effluent	< 5	5	0.5	ug/L	Caltest	EPA 625	
72	4-Chlorophenyl Phenyl Ether	01/05/05	E-2 Effluent	< 5	5	2	ug/L	Caltest	EPA 625	4
72	4-Chlorophenyl Phenyl Ether	01/03/06	E-2 Effluent	< 5	5	2	ug/L	Caltest	EPA 625	
73	Chrysene	12/31/03	E-2 Effluent	< 0.3	0.3	0.14	ug/L	Caltest	EPA 610	
73	Chrysene	01/09/04	E-2 Effluent	< 0.3	0.3	0.14	ug/L	Caltest	EPA 610	
73	Chrysene	01/05/05	E-2 Effluent	< 0.33	0.33	0.044	ug/L	Caltest	EPA 610	
73	Chrysene	01/03/06	E-2 Effluent	< 0.3	0.3	0.02	ug/L	Caltest	EPA 610	
74	Dibenzo(a,h)Anthracene	12/31/03	E-2 Effluent	< 0.1	0.1	0.04	ug/L	Caltest	EPA 610	
74	Dibenzo(a,h)Anthracene	01/09/04	E-2 Effluent	< 0.1	0.1	0.04	ug/L	Caltest	EPA 610	
74	Dibenzo(a,h)Anthracene	01/05/05	E-2 Effluent	< 0.11	0.11	0.033	ug/L	Caltest	EPA 610	
74	Dibenzo(a,h)Anthracene	01/03/06	E-2 Effluent	< 0.1	0.1	0.03	ug/L	Caltest	EPA 610	
75	1,2-Dichlorobenzene	01/09/04	E-2 Effluent	< 0.5	0.5	0.2	ug/L	Caltest	EPA 624	
75	1,2-Dichlorobenzene	01/04/05	E-2 Effluent	< 0.5	0.5	0.05	ug/L	Caltest	EPA 624	
75	1,2-Dichlorobenzene	01/03/06	E-2 Effluent	< 0.5	0.5	0.06	ug/L	Caltest	EPA 624	
76	1,3-Dichlorobenzene	01/09/04	E-2 Effluent	< 0.5	0.5	0.3	ug/L	Caltest	EPA 624	
76	1,3-Dichlorobenzene	01/04/05	E-2 Effluent	< 0.5	0.5	0.07	ug/L	Caltest	EPA 624	
76	1,3-Dichlorobenzene	01/03/06	E-2 Effluent	< 0.5	0.5	0.07	ug/L	Caltest	EPA 624	
77	1,4-Dichlorobenzene (volatile)	01/09/04	E-2 Effluent	< 0.5	0.5	0.3	ug/L	Caltest	EPA 624	1
77	1,4-Dichlorobenzene (volatile)	01/04/05	E-2 Effluent	< 0.5	0.5	0.06	ug/L	Caltest	EPA 624	
77	1,4-Dichlorobenzene (volatile)	01/03/06	E-2 Effluent	J 0.2	0.5	0.06	ug/L	Caltest	EPA 624	
78	3,3'-Dichlorobenzidine	01/09/04	E-2 Effluent	< 5	5	0.3	ug/L	Caltest	EPA 625	
78	3,3'-Dichlorobenzidine	01/05/05	E-2 Effluent	< 5	5	0.6	ug/L	Caltest	EPA 625	4
78	3,3'-Dichlorobenzidine	01/03/06	E-2 Effluent	< 5	5	0.6	ug/L	Caltest	EPA 625	
79	Diethyl Phthalate	01/09/04	E-2 Effluent	< 2	2	0.7	ug/L	Caltest	EPA 625	
79	Diethyl Phthalate	01/05/05	E-2 Effluent	< 2	2	0.9	ug/L	Caltest	EPA 625	4
79	Diethyl Phthalate	01/03/06	E-2 Effluent	< 2	2	0.9	ug/L	Caltest	EPA 625	
80	Dimethyl Phthalate	01/09/04	E-2 Effluent	< 2	2	0.7	ug/L	Caltest	EPA 625	
80	Dimethyl Phthalate	01/05/05	E-2 Effluent	< 2	2	0.6	ug/L	Caltest	EPA 625	4
80	Dimethyl Phthalate	01/03/06	E-2 Effluent	< 2	2	0.6	ug/L	Caltest	EPA 625	
81	Di-n-Butyl Phthalate	01/09/04	E-2 Effluent	< 5	5	1	ug/L	Caltest	EPA 625	
81	Di-n-Butyl Phthalate	01/05/05	E-2 Effluent	< 5	5	0.6	ug/L	Caltest	EPA 625	4
81	Di-n-Butyl Phthalate	01/03/06	E-2 Effluent	< 5	5	0.6	ug/L	Caltest	EPA 625	

Fact Sheet Appendix F-6(b)

City of Calistoga
NPDES Permit Reissuance
Effluent Data E-2

CTR #	CONSTITUENT	SAMPLE DATE	SAMPLE LOCATION	RESULT	RL	MDL	UNITS	ANALYTICAL LABORATORY	ANALYTICAL METHOD	NOTES
82	2,4-Dinitrotoluene	01/09/04	E-2 Effluent	< 5	5	0.6	ug/L	Caltest	EPA 625	
82	2,4-Dinitrotoluene	01/05/05	E-2 Effluent	< 5	5	0.9	ug/L	Caltest	EPA 625	4
82	2,4-Dinitrotoluene	01/03/06	E-2 Effluent	< 5	5	0.9	ug/L	Caltest	EPA 625	
83	2,6-Dinitrotoluene	01/09/04	E-2 Effluent	< 5	5	0.6	ug/L	Caltest	EPA 625	
83	2,6-Dinitrotoluene	01/05/05	E-2 Effluent	< 5	5	0.5	ug/L	Caltest	EPA 625	4
83	2,6-Dinitrotoluene	01/03/06	E-2 Effluent	< 5	5	0.6	ug/L	Caltest	EPA 625	
84	Di-n-Octyl Phthalate	01/09/04	E-2 Effluent	< 5	5	0.9	ug/L	Caltest	EPA 625	
84	Di-n-Octyl Phthalate	01/05/05	E-2 Effluent	< 5	5	0.7	ug/L	Caltest	EPA 625	4
84	Di-n-Octyl Phthalate	01/03/06	E-2 Effluent	< 5	5	0.7	ug/L	Caltest	EPA 625	
85	1,2-Diphenylhydrazine	01/09/04	E-2 Effluent	< 1	1	0.6	ug/L	Caltest	EPA 625	
85	1,2-Diphenylhydrazine	01/05/05	E-2 Effluent	< 1	1	0.9	ug/L	Caltest	EPA 625	4
85	1,2-Diphenylhydrazine	01/03/06	E-2 Effluent	< 1	1	0.9	ug/L	Caltest	EPA 625	
86	Fluoranthene	12/31/03	E-2 Effluent	< 0.05	0.05	0.03	ug/L	Caltest	EPA 610	
86	Fluoranthene	01/09/04	E-2 Effluent	< 0.05	0.05	0.03	ug/L	Caltest	EPA 610	
86	Fluoranthene	01/05/05	E-2 Effluent	< 0.06	0.06	0.033	ug/L	Caltest	EPA 610	
86	Fluoranthene	01/03/06	E-2 Effluent	< 0.05	0.05	0.03	ug/L	Caltest	EPA 610	
87	Fluorene	12/31/03	E-2 Effluent	< 0.1	0.1	0.02	ug/L	Caltest	EPA 610	
87	Fluorene	01/09/04	E-2 Effluent	< 0.1	0.1	0.02	ug/L	Caltest	EPA 610	
87	Fluorene	01/05/05	E-2 Effluent	< 0.11	0.11	0.032	ug/L	Caltest	EPA 610	
87	Fluorene	01/03/06	E-2 Effluent	< 0.1	0.1	0.03	ug/L	Caltest	EPA 610	
88	Hexachlorobenzene	01/09/04	E-2 Effluent	< 1	1	0.4	ug/L	Caltest	EPA 625	
88	Hexachlorobenzene	01/05/05	E-2 Effluent	< 1	1	0.8	ug/L	Caltest	EPA 625	4
88	Hexachlorobenzene	01/03/06	E-2 Effluent	< 1	1	0.8	ug/L	Caltest	EPA 625	
89	Hexachlorobutadiene	01/09/04	E-2 Effluent	< 1	1	0.7	ug/L	Caltest	EPA 625	
89	Hexachlorobutadiene	01/05/05	E-2 Effluent	< 1	1	0.8	ug/L	Caltest	EPA 625	4
89	Hexachlorobutadiene	01/03/06	E-2 Effluent	< 1	1	0.8	ug/L	Caltest	EPA 625	
90	Hexachlorocyclopentadiene	01/09/04	E-2 Effluent	< 5	5	0.4	ug/L	Caltest	EPA 625	
90	Hexachlorocyclopentadiene	01/05/05	E-2 Effluent	< 1	1	0.8	ug/L	Caltest	EPA 625	4
90	Hexachlorocyclopentadiene	01/03/06	E-2 Effluent	< 1	1	0.8	ug/L	Caltest	EPA 625	
91	Hexachloroethane	01/09/04	E-2 Effluent	< 1	1	0.6	ug/L	Caltest	EPA 625	
91	Hexachloroethane	01/05/05	E-2 Effluent	< 1	1	0.9	ug/L	Caltest	EPA 625	4
91	Hexachloroethane	01/03/06	E-2 Effluent	< 1	1	0.8	ug/L	Caltest	EPA 625	
92	Indeno(1,2,3-cd)Pyrene	12/31/03	E-2 Effluent	< 0.05	0.05	0.04	ug/L	Caltest	EPA 610	
92	Indeno(1,2,3-cd)Pyrene	01/09/04	E-2 Effluent	< 0.05	0.05	0.04	ug/L	Caltest	EPA 610	
92	Indeno(1,2,3-cd)Pyrene	01/05/05	E-2 Effluent	< 0.06	0.06	0.033	ug/L	Caltest	EPA 610	
92	Indeno(1,2,3-cd)Pyrene	01/03/06	E-2 Effluent	< 0.05	0.05	0.02	ug/L	Caltest	EPA 610	
93	Isophorone	01/09/04	E-2 Effluent	< 1	1	0.8	ug/L	Caltest	EPA 625	
93	Isophorone	01/05/05	E-2 Effluent	< 1	1	0.5	ug/L	Caltest	EPA 625	4
93	Isophorone	01/03/06	E-2 Effluent	< 1	1	0.5	ug/L	Caltest	EPA 625	
94	Naphthalene	12/31/03	E-2 Effluent	< 0.2	0.2	0.05	ug/L	Caltest	EPA 610	
94	Naphthalene	01/09/04	E-2 Effluent	< 0.2	0.2	0.05	ug/L	Caltest	EPA 610	
94	Naphthalene	01/05/05	E-2 Effluent	< 0.2	0.2	0.022	ug/L	Caltest	EPA 610	
94	Naphthalene	01/03/06	E-2 Effluent	< 0.2	0.2	0.02	ug/L	Caltest	EPA 610	
95	Nitrobenzene	01/09/04	E-2 Effluent	< 1	1	0.7	ug/L	Caltest	EPA 625	
95	Nitrobenzene	01/05/05	E-2 Effluent	< 1	1	0.7	ug/L	Caltest	EPA 625	4
95	Nitrobenzene	01/03/06	E-2 Effluent	< 1	1	0.7	ug/L	Caltest	EPA 625	
96	N-Nitrosodimethylamine	01/09/04	E-2 Effluent	< 5	5	0.6	ug/L	Caltest	EPA 625	
96	N-Nitrosodimethylamine	01/05/05	E-2 Effluent	< 5	5	0.6	ug/L	Caltest	EPA 625	4
96	N-Nitrosodimethylamine	01/03/06	E-2 Effluent	< 5	5	0.6	ug/L	Caltest	EPA 625	
97	N-Nitrosodi-n-Propylamine	01/09/04	E-2 Effluent	< 5	5	0.8	ug/L	Caltest	EPA 625	
97	N-Nitrosodi-n-Propylamine	01/05/05	E-2 Effluent	< 5	5	0.8	ug/L	Caltest	EPA 625	4
97	N-Nitrosodi-n-Propylamine	01/03/06	E-2 Effluent	< 5	5	0.8	ug/L	Caltest	EPA 625	
98	N-Nitrosodiphenylamine	01/09/04	E-2 Effluent	< 1	1	0.7	ug/L	Caltest	EPA 625	
98	N-Nitrosodiphenylamine	01/05/05	E-2 Effluent	< 1	1	0.6	ug/L	Caltest	EPA 625	4
98	N-Nitrosodiphenylamine	01/03/06	E-2 Effluent	< 1	1	0.6	ug/L	Caltest	EPA 625	
99	Phenanthrene	12/31/03	E-2 Effluent	< 0.05	0.05	0.03	ug/L	Caltest	EPA 610	
99	Phenanthrene	01/09/04	E-2 Effluent	< 0.05	0.05	0.03	ug/L	Caltest	EPA 610	
99	Phenanthrene	01/05/05	E-2 Effluent	< 0.06	0.06	0.033	ug/L	Caltest	EPA 610	
99	Phenanthrene	01/03/06	E-2 Effluent	< 0.05	0.05	0.02	ug/L	Caltest	EPA 610	
100	Pyrene	12/31/03	E-2 Effluent	< 0.05	0.05	0.03	ug/L	Caltest	EPA 610	
100	Pyrene	01/09/04	E-2 Effluent	< 0.05	0.05	0.03	ug/L	Caltest	EPA 610	
100	Pyrene	01/05/05	E-2 Effluent	< 0.06	0.06	0.033	ug/L	Caltest	EPA 610	
100	Pyrene	01/03/06	E-2 Effluent	< 0.05	0.05	0.02	ug/L	Caltest	EPA 610	
101	1,2,4-Trichlorobenzene	01/09/04	E-2 Effluent	< 5	5	0.6	ug/L	Caltest	EPA 625	
101	1,2,4-Trichlorobenzene	01/05/05	E-2 Effluent	< 5	5	1.3	ug/L	Caltest	EPA 625	4

Fact Sheet Appendix F-6(b)

City of Calistoga
NPDES Permit Reissuance
Effluent Data E-2

CTR #	CONSTITUENT	SAMPLE DATE	SAMPLE LOCATION	RESULT	RL	MDL	UNITS	ANALYTICAL LABORATORY	ANALYTICAL METHOD	NOTES
101	1,2,4-Trichlorobenzene	01/03/06	E-2 Effluent	< 5	5	1.3	ug/L	Caltest	EPA 625	
102	Aldrin	01/09/04	E-2 Effluent	< 0.005	0.005	0.003	ug/L	Caltest	EPA 608	
102	Aldrin	01/05/05	E-2 Effluent	< 0.005	0.005	0.0032	ug/L	Caltest	EPA 608	
102	Aldrin	01/03/06	E-2 Effluent	< 0.005	0.005	0.002	ug/L	Caltest	EPA 608	
103	alpha-BHC	01/09/04	E-2 Effluent	< 0.01	0.01	0.003	ug/L	Caltest	EPA 608	
103	alpha-BHC	01/05/05	E-2 Effluent	< 0.011	0.011	0.0032	ug/L	Caltest	EPA 608	
103	alpha-BHC	01/03/06	E-2 Effluent	< 0.01	0.01	0.003	ug/L	Caltest	EPA 608	
104	beta-BHC	01/09/04	E-2 Effluent	< 0.005	0.005	0.004	ug/L	Caltest	EPA 608	
104	beta-BHC	01/05/05	E-2 Effluent	< 0.005	0.005	0.0032	ug/L	Caltest	EPA 608	
104	beta-BHC	01/03/06	E-2 Effluent	< 0.005	0.005	0.003	ug/L	Caltest	EPA 608	
105	gamma-BHC (Lindane)	01/09/04	E-2 Effluent	< 0.01	0.01	0.003	ug/L	Caltest	EPA 608	
105	gamma-BHC (Lindane)	01/05/05	E-2 Effluent	< 0.011	0.011	0.0032	ug/L	Caltest	EPA 608	
105	gamma-BHC (Lindane)	01/03/06	E-2 Effluent	< 0.01	0.01	0.002	ug/L	Caltest	EPA 608	
106	delta-BHC	01/09/04	E-2 Effluent	< 0.005	0.005	0.002	ug/L	Caltest	EPA 608	
106	delta-BHC	01/05/05	E-2 Effluent	< 0.005	0.005	0.0032	ug/L	Caltest	EPA 608	
106	delta-BHC	01/03/06	E-2 Effluent	< 0.005	0.005	0.002	ug/L	Caltest	EPA 608	
107	Chlordane	01/09/04	E-2 Effluent	< 0.02	0.02	0.005	ug/L	Caltest	EPA 608	
107	Chlordane	01/05/05	E-2 Effluent	< 0.022	0.022	0.022	ug/L	Caltest	EPA 608	
107	Chlordane	01/03/06	E-2 Effluent	< 0.02	0.02	0.02	ug/L	Caltest	EPA 608	
108	4,4'-DDT	01/09/04	E-2 Effluent	< 0.01	0.01	0.003	ug/L	Caltest	EPA 608	
108	4,4'-DDT	01/05/05	E-2 Effluent	< 0.011	0.011	0.0032	ug/L	Caltest	EPA 608	
108	4,4'-DDT	01/03/06	E-2 Effluent	< 0.01	0.01	0.002	ug/L	Caltest	EPA 608	
109	4,4'-DDE	01/09/04	E-2 Effluent	< 0.01	0.01	0.002	ug/L	Caltest	EPA 608	
109	4,4'-DDE	01/05/05	E-2 Effluent	< 0.011	0.011	0.0032	ug/L	Caltest	EPA 608	
109	4,4'-DDE	01/03/06	E-2 Effluent	< 0.01	0.01	0.003	ug/L	Caltest	EPA 608	
110	4,4'-DDD	01/09/04	E-2 Effluent	< 0.01	0.01	0.002	ug/L	Caltest	EPA 608	
110	4,4'-DDD	01/05/05	E-2 Effluent	< 0.011	0.011	0.0022	ug/L	Caltest	EPA 608	
110	4,4'-DDD	01/03/06	E-2 Effluent	< 0.01	0.01	0.002	ug/L	Caltest	EPA 608	
111	Dieldrin	01/09/04	E-2 Effluent	< 0.01	0.01	0.002	ug/L	Caltest	EPA 608	
111	Dieldrin	01/05/05	E-2 Effluent	< 0.011	0.011	0.0022	ug/L	Caltest	EPA 608	
111	Dieldrin	01/03/06	E-2 Effluent	< 0.01	0.01	0.002	ug/L	Caltest	EPA 608	
112	Endosulfan I (alpha)	01/09/04	E-2 Effluent	< 0.01	0.01	0.002	ug/L	Caltest	EPA 608	
112	Endosulfan I (alpha)	01/05/05	E-2 Effluent	< 0.011	0.011	0.0022	ug/L	Caltest	EPA 608	
112	Endosulfan I (alpha)	01/03/06	E-2 Effluent	< 0.01	0.01	0.003	ug/L	Caltest	EPA 608	
113	Endosulfan II (beta)	01/09/04	E-2 Effluent	< 0.01	0.01	0.002	ug/L	Caltest	EPA 608	
113	Endosulfan II (beta)	01/05/05	E-2 Effluent	< 0.011	0.011	0.0022	ug/L	Caltest	EPA 608	
113	Endosulfan II (beta)	01/03/06	E-2 Effluent	< 0.01	0.01	0.002	ug/L	Caltest	EPA 608	
114	Endosulfan Sulfate	01/09/04	E-2 Effluent	< 0.01	0.01	0.002	ug/L	Caltest	EPA 608	
114	Endosulfan Sulfate	01/05/05	E-2 Effluent	< 0.011	0.011	0.0032	ug/L	Caltest	EPA 608	
114	Endosulfan Sulfate	01/03/06	E-2 Effluent	< 0.01	0.01	0.002	ug/L	Caltest	EPA 608	
115	Endrin	01/09/04	E-2 Effluent	< 0.01	0.01	0.002	ug/L	Caltest	EPA 608	
115	Endrin	01/05/05	E-2 Effluent	< 0.011	0.011	0.0022	ug/L	Caltest	EPA 608	
115	Endrin	01/03/06	E-2 Effluent	< 0.01	0.01	0.002	ug/L	Caltest	EPA 608	
116	Endrin Aldehyde	01/09/04	E-2 Effluent	< 0.01	0.01	0.002	ug/L	Caltest	EPA 608	
116	Endrin Aldehyde	01/05/05	E-2 Effluent	< 0.011	0.011	0.0032	ug/L	Caltest	EPA 608	
116	Endrin Aldehyde	01/03/06	E-2 Effluent	< 0.01	0.01	0.003	ug/L	Caltest	EPA 608	
117	Heptachlor	01/09/04	E-2 Effluent	< 0.01	0.01	0.003	ug/L	Caltest	EPA 608	
117	Heptachlor	01/05/05	E-2 Effluent	< 0.011	0.011	0.0032	ug/L	Caltest	EPA 608	
117	Heptachlor	01/03/06	E-2 Effluent	< 0.01	0.01	0.003	ug/L	Caltest	EPA 608	
118	Heptachlor Epoxide	01/09/04	E-2 Effluent	< 0.01	0.01	0.003	ug/L	Caltest	EPA 608	
118	Heptachlor Epoxide	01/05/05	E-2 Effluent	< 0.011	0.011	0.0022	ug/L	Caltest	EPA 608	
118	Heptachlor Epoxide	01/03/06	E-2 Effluent	< 0.01	0.01	0.002	ug/L	Caltest	EPA 608	
119	PCB 1016	01/09/04	E-2 Effluent	< 0.1	0.1	0.05	ug/L	Caltest	EPA 608	
119	PCB 1016	01/05/05	E-2 Effluent	< 0.11	0.11	0.032	ug/L	Caltest	EPA 608	
119	PCB 1016	01/03/06	E-2 Effluent	< 0.1	0.1	0.05	ug/L	Caltest	EPA 608	
120	PCB 1221	01/09/04	E-2 Effluent	< 0.1	0.1	0.03	ug/L	Caltest	EPA 608	
120	PCB 1221	01/05/05	E-2 Effluent	< 0.11	0.11	0.054	ug/L	Caltest	EPA 608	
120	PCB 1221	01/03/06	E-2 Effluent	< 0.1	0.1	0.06	ug/L	Caltest	EPA 608	
121	PCB 1232	01/09/04	E-2 Effluent	< 0.1	0.1	0.04	ug/L	Caltest	EPA 608	
121	PCB 1232	01/05/05	E-2 Effluent	< 0.11	0.11	0.065	ug/L	Caltest	EPA 608	
121	PCB 1232	01/03/06	E-2 Effluent	< 0.1	0.1	0.04	ug/L	Caltest	EPA 608	
122	PCB 1242	01/09/04	E-2 Effluent	< 0.1	0.1	0.05	ug/L	Caltest	EPA 608	
122	PCB 1242	01/05/05	E-2 Effluent	< 0.11	0.11	0.043	ug/L	Caltest	EPA 608	
122	PCB 1242	01/03/06	E-2 Effluent	< 0.1	0.1	0.06	ug/L	Caltest	EPA 608	

Fact Sheet Appendix F-6(b)

City of Calistoga
 NPDES Permit Reissuance
 Effluent Data E-2

CTR #	CONSTITUENT	SAMPLE DATE	SAMPLE LOCATION	RESULT	RL	MDL	UNITS	ANALYTICAL LABORATORY	ANALYTICAL METHOD	NOTES
123	PCB 1248	01/09/04	E-2 Effluent	< 0.1	0.1	0.05	ug/L	Caltest	EPA 608	
123	PCB 1248	01/05/05	E-2 Effluent	< 0.11	0.11	0.054	ug/L	Caltest	EPA 608	
123	PCB 1248	01/03/06	E-2 Effluent	< 0.1	0.1	0.05	ug/L	Caltest	EPA 608	
124	PCB 1254	01/09/04	E-2 Effluent	< 0.1	0.1	0.07	ug/L	Caltest	EPA 608	
124	PCB 1254	01/05/05	E-2 Effluent	< 0.11	0.11	0.065	ug/L	Caltest	EPA 608	
124	PCB 1254	01/03/06	E-2 Effluent	< 0.1	0.1	0.04	ug/L	Caltest	EPA 608	
125	PCB 1260	01/09/04	E-2 Effluent	< 0.1	0.1	0.05	ug/L	Caltest	EPA 608	
125	PCB 1260	01/05/05	E-2 Effluent	< 0.11	0.11	0.065	ug/L	Caltest	EPA 608	
125	PCB 1260	01/03/06	E-2 Effluent	< 0.1	0.1	0.03	ug/L	Caltest	EPA 608	
126	Toxaphene	01/09/04	E-2 Effluent	< 0.5	0.5	0.4	ug/L	Caltest	EPA 608	
126	Toxaphene	01/05/05	E-2 Effluent	< 0.5	0.5	0.16	ug/L	Caltest	EPA 608	
126	Toxaphene	01/03/06	E-2 Effluent	< 0.5	0.5	0.15	ug/L	Caltest	EPA 608	
	Chlorpyrifos	01/09/04	E-2 Effluent	< 0.05	0.05	0.04	ug/L	Caltest	EPA 614	
	Chlorpyrifos	01/04/05	E-2 Effluent	< 0.06	0.06	0.033	ug/L	Caltest	EPA 614	
	Chlorpyrifos	01/03/06	E-2 Effluent	< 0.05	0.05	0.03	ug/L	Caltest	EPA 614	
	Diazinon	01/09/04	E-2 Effluent	< 0.05	0.05	0.04	ug/L	Caltest	EPA 614	
	Diazinon	01/04/05	E-2 Effluent	< 0.06	0.06	0.044	ug/L	Caltest	EPA 614	
	Diazinon	01/03/06	E-2 Effluent	< 0.05	0.05	0.04	ug/L	Caltest	EPA 614	
	Tributyltin	01/09/04	E-2 Effluent	< 0.0015	0.0015	0.00048	ug/L	STL	Krone	
	Tributyltin	01/05/05	E-2 Effluent	< 0.0015	0.0015	0.00049	ug/L	STL	Krone	
	Tributyltin	01/03/06	E-2 Effluent	< 0.0021	0.0021	0.00051	ug/L	STL	Krone	

Fact Sheet Appendix 6(c)

City of Calistoga
Effluent Data
Dioxin Congeners

January 9, 2004	E-1				E-2				
	Analyte	Concentration (pg/L)	DL	MDL	Qualifiers	Concentration (pg/L)	DL	MDL	Qualifiers
2,3,7,8-TCDD	ND	1.81	0.637			ND	1.69	0.637	
1,2,3,7,8-PeCDD	ND	2.97	2.81			ND	2.99	2.81	
1,2,3,4,7,8-HxCDD	ND	3.56	1.75			ND	2.77	1.75	
1,2,3,6,7,8-HxCDD	ND	3.8	1.87			ND	2.95	1.87	
1,2,3,7,8,9-HxCDD	ND	3.66	2.71			ND	2.85	2.71	
1,2,3,4,6,7,8-HpCDD	ND	4.99	3.05			ND	2.47	3.05	
OCDD	7.77		6.96	A		ND		6.96	
2,3,7,8-TCDF	ND	1.77	1.03			ND	1.62	1.03	
1,2,3,7,8-PeCDF	ND	2.96	2.25			ND	2.94	2.25	
2,3,4,7,8-PeCDF	ND	2.55	2.38			ND	2.71	2.38	
1,2,3,4,7,8-HxCDF	ND	2.02	2.38			ND	1.51	2.38	
1,2,3,6,7,8-HxCDF	ND	2.05	2.44			ND	1.53	2.44	
2,3,4,6,7,8-HxCDF	ND	2.22	3.06			ND	1.68	3.06	
1,2,3,7,8,9-HxCDF	ND	3.16	2.31			ND	2.31	2.31	
1,2,3,4,6,7,8-HpCDF	ND	3.18	3.57			ND	1.82	3.57	
1,2,3,4,7,8,9-HpCDF	ND	3.89	3.13			ND	2.26	3.13	
OCDF	ND	6.63	6.17			ND	7.4	6.17	
E-1 TEQ: 0.000777					E-2 TEQ: 0				
Blank TEQ:					Blank TEQ:				

January 5, 2005	E-1				E-2				
	Analyte	Concentration (pg/L)	DL	MDL	Qualifiers	Concentration (pg/L)	DL	MDL	Qualifiers
2,3,7,8-TCDD	ND	0.276	0.699			ND	0.369	0.699	
1,2,3,7,8-PeCDD	ND	0.527	1.12			ND	0.974	1.12	
1,2,3,4,7,8-HxCDD	ND	0.780	0.727			ND	0.844	0.727	
1,2,3,6,7,8-HxCDD	ND	0.794	0.729			ND	0.813	0.729	
1,2,3,7,8,9-HxCDD	ND	0.711	2.22			ND	0.748	2.22	
1,2,3,4,6,7,8-HpCDD	ND		0.826	EMPC = 0.939		ND		0.826	EMPC = 1.49
OCDD	ND		2.43	EMPC = 3.12		6.70		2.43	1
2,3,7,8-TCDF	ND	0.371	0.486			ND	0.432	0.486	
1,2,3,7,8-PeCDF	ND	0.443	1.26			ND	0.657	1.26	
2,3,4,7,8-PeCDF	ND	0.430	0.707			ND	0.568	0.707	
1,2,3,4,7,8-HxCDF	ND	0.310	0.932			ND	0.214	0.932	
1,2,3,6,7,8-HxCDF	ND	0.324	0.937			ND	0.937	0.937	*
2,3,4,6,7,8-HxCDF	ND	0.343	0.932			ND	0.226	0.932	
1,2,3,7,8,9-HxCDF	ND	0.462	1.65			ND	0.306	1.65	
1,2,3,4,6,7,8-HpCDF	ND	0.308	1.21			ND	0.388	1.21	
1,2,3,4,7,8,9-HpCDF	ND	0.253	1.52			ND	0.505	1.52	
OCDF	ND	1.29	1.78			ND	1.31	1.78	
E-1 TEQ: 0					E-2 TEQ: 0.000670				
Blank TEQ: 0					Blank TEQ: 0				

Data for Priority Pollutants with Effluent Limitations and Probability Plots

Outfall	Cu			Hg			CN			Chlorodibromomethane			Dichlorobromomethane			
	Date	<	ug/l	Date	<	ug/l	Date	<	ug/l	Date	<	ug/l	Date	<	ug/l	
E-1	11/19/03	<	3	11/19/03	<	0.0022	11/18/03	J	1.9	E-1	01/09/04	<	4.5	01/09/04	<	13
E-1	12/10/03	<	3.8	12/10/03	<	0.0016	12/09/03	<	3	E-1	01/04/05	<	2.9	01/04/05	<	10
E-1	01/09/04	<	4	01/09/04	<	0.0023	01/09/04	<	0.9	E-1	01/03/06	<	3	01/03/06	<	9
E-1	02/11/04	<	4	02/11/04	<	0.0031	02/10/04	<	4	E-2	01/09/04	<	4.5	01/09/04	<	12
E-1	03/02/04	<	4.3	03/02/04	<	0.0021	03/02/04	<	6	E-2	01/04/05	<	4.9	01/04/05	<	13
E-1	04/07/04	<	6.7	04/07/04	<	0.001	04/06/04	<	6	E-2	01/03/06	<	2.1	01/03/06	<	6.5
E-1	05/05/04	<	9	05/05/04	<	0.0012	05/11/04	J	1							
E-1	11/17/04	<	4.6	11/17/04	<	0.0012	11/17/04	<	4.7							
E-1	12/09/04	<	5	12/09/04	<	0.0022	12/08/04	<	0.8							
E-1	01/04/05	<	2.1	01/04/05	<	0.0021	01/04/05	<	0.8							
E-1	02/08/05	<	3.1	02/08/05	<	0.0009	02/08/05	<	0.8							
E-1	03/03/05	<	3.4	03/03/05	<	0.0014	03/03/05	<	0.8							
E-1	04/05/05	<	3.4	04/05/05	<	0.0008	04/05/05	<	4.3							
E-1	05/04/05	<	7.1	05/04/05	<	0.0018	05/04/05	<	0.8							
E-1	11/29/05	<	5	11/29/05	<	0.0008	11/29/05	<	3.9							
E-1	12/07/05	<	4.4	12/07/05	<	0.0008	12/13/05	<	4.4							
E-1	01/03/06	<	1.7	01/03/06	<	0.0015	01/03/06	<	4.6							
E-2	12/31/03	<	8.8	12/31/03	<	0.0068	12/30/03	J	1.1							
E-2	01/09/04	<	5.0	01/09/04	<	0.0042	01/09/04	<	3							
E-2	02/11/04	<	4.4	02/11/04	<	0.0042	02/10/04	J	2.8							
E-2	03/02/04	<	5.0	03/03/04	<	0.0043	03/02/04	<	4							
E-2	12/09/04	<	5.7	12/09/04	<	0.0052	12/09/04	<	3							
E-2	01/04/05	<	2.9	01/04/05	<	0.0074	01/04/05	<	4							
E-2	03/03/05	<	4.8	03/04/05	<	0.0042	03/03/05	<	3.3							
E-2	05/11/05	<	8.1	05/12/05	<	0.0044	05/11/05	<	9.2							
E-2	12/27/05	<	3.4	12/28/05	<	0.0059	12/27/05	<	3							
E-2	01/03/06	<	2.5	01/03/06	<	0.0044	01/03/06	<	3.1							

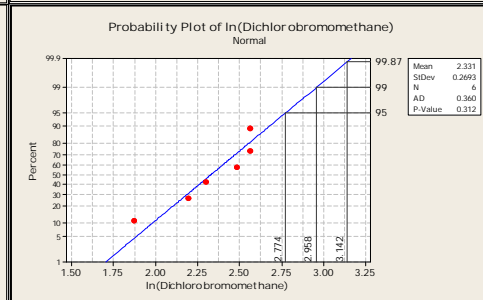
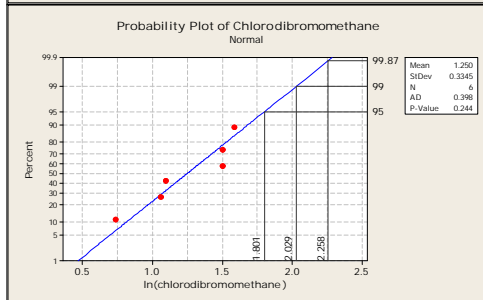
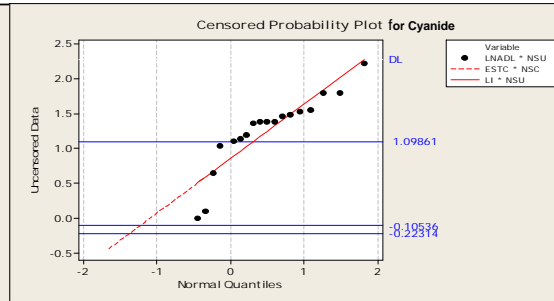
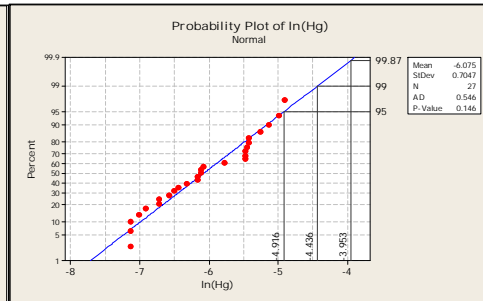
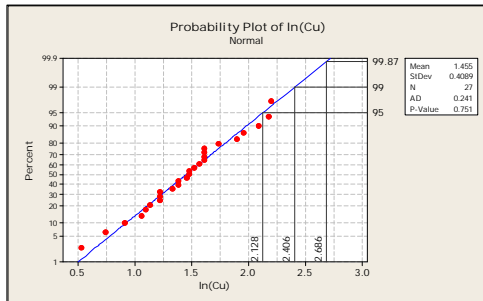

Fact Sheet Appendix F-7

**Napa River Ambient Monitoring Data
(Calistoga Station)**

Fact Sheet Appendix F-7

Napa River Ambient Background Monitoring Data
Calistoga Station

CTR#	CONSTITUENT	C-1	C-2	C-3	C-4	C-MEC
1	Antimony	0.7	1	0.3	< 0.2	0.7
2	Arsenic	1.3	2.4	5.9	6	6
3	Beryllium	< 0.06	< 0.06	< 0.06	< 0.06	< 0.06
4	Cadmium	< 0.04	< 0.04	< 0.03	< 0.03	< 0.03
5a	Chromium (III)	0.6	< 0.2	< 0.2	< 0.2	0.6
5b	Chromium (VI)	< 2	< 0.15	< 0.15	< 0.15	< 0.15
6	Copper	0.9	1	1.1	1	1.1
7	Lead	0.21	0.012	0.053	< 0.04	0.21
8	Mercury	0.015	0.0066	0.0061	0.003	0.015
9	Nickel	1.9	2.2	3.8	4	4
10	Selenium	< 0.3	< 0.5	< 0.5	< 0.5	< 0.3
11	Silver	0.02	0.03	< 0.02	< 0.02	0.03
12	Thallium	0.2	0.08	< 0.03	< 0.03	0.2
13	Zinc	2	0.9	1	1.6	2
14	Cyanide	< 0.6	< 0.1	0.197	< 0.1	< 0.1
15	Asbestos	< 0.19	< 0.2	< 0.2	< 0.2	< 0.19
16	2, 3, 7, 8-TCDD (Dioxin)	< 0.847	< 0.847	< 0.637	< 0.637	
17	Acrolein	< 3.3	< 3.3	< 1	< 1	< 1
18	Acrylonitrile	< 1.6	< 1.6	< 1	< 1	< 1
19	Benzene	< 0.27	< 0.27	< 0.3	< 0.3	< 0.27
20	Bromoform	< 0.1	< 0.1	< 0.2	< 0.2	< 0.1
21	Carbon Tetrachloride	< 0.42	< 0.42	< 0.42	< 0.42	< 0.42
22	Chlorobenzene	< 0.19	< 0.19	< 0.3	< 0.3	< 0.19
23	Chlorodibromomethane	< 0.18	< 0.18	< 0.3	< 0.3	< 0.18
24	Chloroethane	< 0.34	< 0.34	< 0.34	< 0.34	< 0.34
25	2-Chloroethylvinyl Ether	< 0.31	< 0.31	< 0.32	< 0.32	< 0.31
26	Chloroform	< 0.24	< 0.24	< 0.31	< 0.31	< 0.24
27	Dichlorobromomethane	< 0.46	< 0.46	< 0.2	< 0.2	< 0.2
28	1,1-Dichloroethane	< 0.28	< 0.28	< 0.34	< 0.34	< 0.28
29	1,2-Dichloroethane	< 0.18	< 0.18	< 0.2	< 0.2	< 0.18
30	1, 1-Dichloroethylene or 1,1 Dichloroethene	< 0.37	< 0.37	< 0.49	< 0.49	< 0.37
31	1, 2-Dichloropropane	< 0.22	< 0.22	< 0.2	< 0.2	< 0.2
32	cis-1,3 Dichloropropene	< 0.25	< 0.25	< 0.2	< 0.2	< 0.2
32	trans-1,3-Dichloropropene	< 0.22	< 0.22	< 0.3	< 0.3	< 0.22
33	Ethylbenzene	< 0.3	< 0.3	< 0.4	< 0.4	< 0.3
34	Methyl Bromide	< 0.46	< 0.46	< 0.42	< 0.42	< 0.42
35	Methyl Chloride or Chloromethane	< 0.36	< 0.36	< 0.4	< 0.46	< 0.36
36	Methylene Chloride or Dichloromethane	< 0.38	< 0.38	< 0.4	< 0.4	< 0.38
37	1,1, 2,2-Tetrachloroethane	< 0.34	< 0.34	< 0.3	< 0.3	< 0.3
38	Tetrachloroethylene	< 0.32	< 0.32	< 0.44	< 0.44	< 0.32
39	Toluene	< 0.25	< 0.25	< 0.32	< 0.32	< 0.25
40	1,2-Trans-Dichloroethylene	< 0.3	< 0.3	< 0.43	< 0.43	< 0.3
41	1,1,1-Trichloroethane	< 0.35	< 0.35	< 0.49	< 0.49	< 0.35
42	1,1,2-Trichloroethane	< 0.27	< 0.27	< 0.3	< 0.3	< 0.27
43	Trichloroethylene or Trichloroethene	< 0.29	< 0.29	< 0.3	< 0.3	< 0.29
44	Vinyl Chloride	< 0.34	< 0.34	< 0.47	< 0.47	< 0.34
45	2-Chlorophenol	< 0.4	< 0.4	< 0.6	< 0.6	< 0.4
46	2, 4 Dichlorophenol	< 0.3	< 0.3	< 0.7	< 0.7	< 0.3
47	2,4-Dimethylphenol	< 0.3	< 0.3	< 0.9	< 0.9	< 0.3
48	methylphenol	< 0.4	< 0.4	< 0.9	< 0.9	< 0.4
49	2,4-Dinitrophenol	< 0.3	< 0.3	< 0.6	< 0.6	< 0.3
50	2-Nitrophenol	< 0.3	< 0.3	< 0.7	< 0.7	< 0.3
51	4-Nitrophenol	< 0.2	< 0.2	< 0.6	< 0.6	< 0.2
52	4-chloro-3-methylphenol	< 0.3	< 0.3	< 0.5	< 0.5	< 0.3
53	Pentachlorophenol	< 0.4	< 0.4	< 0.9	< 0.9	< 0.4
54	Phenol	< 0.2	< 0.2	< 0.4	< 0.4	< 0.2
55	2, 4, 6 Trichlorophenol	< 0.2	< 0.2	< 0.6	< 0.6	< 0.2
56	Acenaphthene	< 0.17	< 0.17	< 0.17	< 0.17	< 0.17
57	Acenaphthylene	< 0.03	< 0.03	< 0.03	< 0.03	< 0.03
58	Anthracene	< 0.16	< 0.16	< 0.16	< 0.16	< 0.16
59	Benidine	< 0.3	< 0.3	< 1	< 1	< 0.3
60	Benzo(a)Anthracene or 1,2 Benzanthracene	< 0.12	< 0.12	< 0.12	< 0.12	< 0.12
61	Benzo(a)Pyrene	< 0.09	< 0.09	< 0.09	< 0.09	< 0.09
62	Benzo(b)Fluoranthene or 3,4 Benzofluoranthene	< 0.11	< 0.11	< 0.11	< 0.11	< 0.11
63	Benzo(ghi)Perylene	< 0.06	< 0.06	< 0.06	< 0.06	< 0.06
64	Benzo(k)Fluoranthene	< 0.16	< 0.16	< 0.16	< 0.16	< 0.16
65	Bis(2-Chloroethoxy) Methane	< 0.3	< 0.3	< 0.9	< 0.9	< 0.3
66	Bis(2-Chloroethyl) Ether	< 0.3	< 0.3	< 0.7	< 0.7	< 0.3

Fact Sheet Appendix F-7

Napa River Ambient Background Monitoring Data
Calistoga Station

CTR#	CONSTITUENT		C-1		C-2		C-3		C-4		C-MEC
67	Bis(2-Chloroisopropyl) Ether	<	1	<	1	<	0.6	<	0.6	<	0.6
68	Bis(2-Ethylhexyl) Phthalate		0.3		0.6	<	0.8	<	0.8		0.6
69	4-Bromophenyl Phenyl Ether	<	0.5	<	0.5	<	0.4	<	0.4	<	0.4
70	Butylbenzyl Phthalate	<	0.4	<	0.4	<	0.8	<	0.8	<	0.4
71	2-Chloronaphthalene	<	0.3	<	0.3	<	0.5	<	0.5	<	0.3
72	4-Chlorophenyl Phenyl Ether	<	0.4	<	0.4	<	0.5	<	0.5	<	0.4
73	Chrysene	<	0.14	<	0.14	<	0.14	<	0.14	<	0.14
74	Dibenzo(a,h) Anthracene	<	0.04	<	0.04	<	0.04	<	0.04	<	0.04
75	1, 2 Dichlorobenzene (semi-volatile)	<	0.4	<	0.4	<	0.6	<	0.6	<	0.4
75	1, 2 Dichlorobenzene (volatile)	<	0.12	<	0.12	<	0.2	<	0.2	<	0.12
76	1, 3 Dichlorobenzene (semi-volatile)	<	0.2	<	0.2	<	0.6	<	0.6	<	0.2
76	1, 3 Dichlorobenzene (volatile)	<	0.16	<	0.16	<	0.3	<	0.3	<	0.16
77	1, 4 Dichlorobenzene (semi-volatile)	<	0.3	<	0.3	<	0.6	<	0.6	<	0.3
77	1, 4 Dichlorobenzene (volatile)	<	0.12	<	0.12	<	0.3	<	0.3	<	0.12
78	3,3'-Dichlorobenzidine	<	0.4	<	0.4	<	0.3	<	0.3	<	0.3
79	Diethyl Phthalate	<	0.4	<	0.4	<	0.7	<	0.7	<	0.4
80	Dimethyl Phthalate	<	0.4	<	0.4	<	0.7	<	0.7	<	0.4
81	Di-n-Butyl Phthalate	<	0.4	<	0.4	<	1	<	1	<	0.4
82	2,4-Dinitrotoluene	<	0.3	<	0.3	<	0.6	<	0.6	<	0.3
83	2,6-Dinitrotoluene	<	0.3	<	0.3	<	0.6	<	0.6	<	0.3
84	Di-n-Octyl Phthalate	<	0.4	<	0.4	<	0.9	<	0.9	<	0.4
85	1,2-Diphenylhydrazine	<	0.3	<	0.3	<	0.6	<	0.6	<	0.3
86	Fluoranthene	<	0.03	<	0.03	<	0.03	<	0.03	<	0.03
87	Fluorene	<	0.02	<	0.02	<	0.02	<	0.02	<	0.02
88	Hexachlorobenzene	<	0.4	<	0.4	<	0.4	<	0.4	<	0.4
89	Hexachlorobutadiene	<	0.2	<	0.2	<	0.7	<	0.7	<	0.2
90	Hexachlorocyclopentadiene	<	0.1	<	0.1	<	0.4	<	0.4	<	0.1
91	Hexachloroethane	<	0.2	<	0.2	<	0.6	<	0.6	<	0.2
92	Indeno(1,2,3-cd)Pyrene	<	0.04	<	0.04	<	0.04	<	0.04	<	0.04
93	Isophorone	<	0.3	<	0.3	<	0.8	<	0.8	<	0.3
94	Naphthalene	<	0.05	<	0.05	<	0.05	<	0.05	<	0.05
95	Nitrobenzene	<	0.3	<	0.3	<	0.7	<	0.7	<	0.3
96	N-Nitrosodimethylamine	<	0.4	<	0.4	<	0.6	<	0.6	<	0.4
97	N-Nitrosodi-n-Propylamine	<	0.3	<	0.3	<	0.8	<	0.8	<	0.3
98	N-Nitrosodiphenylamine	<	0.4	<	0.4	<	0.7	<	0.7	<	0.4
99	Phenanthrene	<	0.03	<	0.03	<	0.03	<	0.03	<	0.03
100	Pyrene	<	0.03	<	0.03	<	0.03	<	0.03	<	0.03
101	1,2,4-Trichlorobenzene	<	0.3	<	0.3	<	0.6	<	0.6	<	0.3
102	Aldrin	<	0.003	<	0.003	<	0.003	<	0.003	<	0.003
103	a-BHC	<	0.002	<	0.002	<	0.003	<	0.003	<	0.002
104	b-BHC	<	0.001	<	0.001	<	0.004	<	0.004	<	0.001
105	g-BHC (Lindane)	<	0.001	<	0.001	<	0.003	<	0.003	<	0.001
106	•-BHC	<	0.001	<	0.001	<	0.002	<	0.002	<	0.001
107	Chlordane	<	0.005	<	0.005	<	0.005	<	0.005	<	0.005
108	4,4'-DDT	<	0.001	<	0.001	<	0.003	<	0.003	<	0.001
109	4,4'-DDE	<	0.001	<	0.001	<	0.002	<	0.002	<	0.001
110	4,4'-DDD	<	0.001	<	0.001	<	0.002	<	0.002	<	0.001
111	Dieldrin	<	0.002	<	0.002	<	0.002	<	0.002	<	0.002
112	Endosulfan I (alpha)	<	0.003	<	0.003	<	0.002	<	0.002	<	0.002
113	Endosulfan II (beta)	<	0.001	<	0.001	<	0.002	<	0.002	<	0.001
114	Endosulfan Sulfate	<	0.001	<	0.001	<	0.002	<	0.002	<	0.001
115	Endrin	<	0.002	<	0.002	<	0.002	<	0.002	<	0.002
116	Endrin Aldehyde	<	0.002	<	0.002	<	0.002	<	0.002	<	0.002
117	Heptachlor	<	0.003	<	0.003	<	0.003	<	0.003	<	0.003
118	Heptachlor Epoxide	<	0.002	<	0.002	<	0.003	<	0.003	<	0.002
119-125	PCBs (h)										
119	PCB 1016	<	0.08	<	0.08	<	0.05	<	0.05	<	0.05
120	PCB 1221	<	0.03	<	0.03	<	0.03	<	0.03	<	0.03
121	PCB 1232	<	0.04	<	0.04	<	0.04	<	0.04	<	0.04
122	PCB 1242	<	0.08	<	0.08	<	0.05	<	0.05	<	0.05
123	PCB 1248	<	0.05	<	0.05	<	0.05	<	0.05	<	0.05
124	PCB 1254	<	0.07	<	0.07	<	0.07	<	0.07	<	0.07
125	PCB 1260	<	0.05	<	0.05	<	0.05	<	0.05	<	0.05
126	Toxaphene	<	0.2	<	0.2	<	0.4	<	0.4	<	0.2
	Chlorpyrifos	<	0.12	<	0.12	<	0.2	<	0.2	<	0.12
	Diazinon	<	0.32	<	0.32	<	0.3	<	0.3	<	0.3
	Tributyltin	<	0.00177	<	0.00158	<	0.0017	<	0.00139	<	0.00139

Fact Sheet Appendix F-8

Calculation of Final QBELs

Fact Sheet Appendix F-8

City of Calistoga
 NPDES Permit Reissuance
 WQBEL Calculation

PRIORITY POLLUTANTS	Copper	Mercury	Cyanide	Chlorodibromo- methane	Dichlorobromo- methane
Units	ug/L	ug/L	ug/L	ug/L	ug/L
Basis and Criteria type	BP FW	BP FW (4-d, 1-hr avg)	NTR FW	CTR Hh	CTR HH
Lowest WQO	6.50	0.025	5.20	0.41	0.56
Translators					
Dilution Factor (D) (if applicable)	0	0	0	0	0
No. of samples per month	4	4	4	4	4
Aquatic life criteria analysis required? (Y/N)	Y	Y	Y	N	N
HH criteria analysis required? (Y/N)	N	Y	Y	Y	Y
Applicable Acute WQO	9.30	2.4	22	na	na
Applicable Chronic WQO	6.50	0.025	5.2	na	na
HH criteria		0.5	700	0.41	0.56
Background (max conc for Aq Life calc)	1.1	0.015	0.197		
Background (avg conc for HH calc)			0.25	0.24	0.33
Is the pollutant Bioaccumulative(Y/N)? (e.g., Hg)	N	Y	N	N	N
ECA acute	93.0	2.4	22		
ECA chronic	6.5	0.025	5.2		
ECA HH		0.5	700	0.41	0.56
No. of data points <10 or at least 80% of data reported non detect? (Y/N)	N	N	N	Y	Y
Avg of effluent data points	4.637	0.0029	2.8981		
Std Dev of effluent data points	1.905	0.0019	2.1934		
CV calculated	0.41	0.67	0.76	N/A	N/A
CV (Selected) - Final	0.41	0.67	0.76	0.6	0.6
ECA acute mult99	0.43	0.29	0.26		
ECA chronic mult99	0.64	0.49	0.46		
LTA acute	40.12	0.70	5.77		
LTA chronic	4.14	0.012	2.37		
minimum of LTAs	4.14	0.012	2.37		
AMEL mult95	1.37	1.62	1.71	1.55	1.55
MDEL mult99	2.32	3.43	3.81	3.11	3.11
AMEL (aq life)	5.66	0.020	4.05		
MDEL(aq life)	9.59	0.042	9.06		
MDEL/AMEL Multiplier	1.69	2.11	2.23	2.01	2.01
AMEL (human hlth)		0.500	700	0.410	0.560
MDEL (human hlth)		1.057	1564	0.823	1.123
minimum of AMEL for Aq. life vs HH	5.7	0.02	4.05	0.410	0.560
minimum of MDEL for Aq. Life vs HH	9.6	0.042	9.06	0.823	1.123
Final limit - AMEL	5.7	0.020	4.1	0.41	0.56
Final limit - MDEL	9.6	0.042	9.1	0.82	1.12
Max Effl Conc (MEC)	9.0	0.0074	9.2	5	13
Feasibility to comply?	No	Yes	No	No	No
Inteirm limit	14.7	NA	21.6	9.5	23
Distribution	lognormal	lognormal	lognormal	lognormal	lognormal
lg mean	1.455	-6.075	0.862	1.25	2.331
lg stdev	0.4089	0.7047	0.737	0.3345	0.2693
95th percentile	8.4	0.0073	8.0	6.1	16.0
99th percentile	11.1	0.0118	13.1	7.6	19.2

Fact Sheet Appendix F-9

Basis for Compliance Schedules

General Basis for Final Compliance Dates [1]
for Discharges North of the Dumbarton Bridge
Revised March 23, 2006

Constituent	Reference for applicable standard	Maximum compliance schedule allowed	Compliance date and Basis
Cyanide Selenium	NTR	10 years	10-yr, but no later than April 28, 2010 (10 years from effective date of SIP). Basis is the Basin Plan, see note [2].
Copper (salt)	CTR	5 years	5-yr, but no later than May 18, 2010. Bases are CTR and SIP. See note [4]
Mercury PAH EPA 610	Numeric Basin Plan (BP)	10 years	10-yr, but no later than April 28, 2010 , which is 10 years from effective date of SIP (April 28, 2000). Basis is the Basin Plan, See note [2a].
Arsenic Cadmium Chromium (VI) Copper (fresh) Lead Nickel Silver (CMC) Zinc	Numeric BP	10 years	10-yr, but no later than January 1, 2015. This is 10 years (using full months) from effective date of 2004 BP amendment (January 5, 2005). Basis is the Basin Plan section 4.3.5.6. See note [2b]. Also, see note [3] for permits issued prior to effective date of 2004 BP amendment.
Dioxins/Furans Tributyltin Other toxic pollutants not in CTR	Narrative BP using SIP methodology	10 years	10-yr from effective date of permit (which is when new standard is adopted; no sunset date). Basis is the Basin Plan, see note [2c].
Other priority pollutants on CTR and not listed above	CTR	5 years	5-yr, but no later than May 18, 2010 (this is 10 years from effective date of CTR/SIP). Basis is the CTR and SIP. See note [4]

[1] These dates are maximum allowable compliance dates applicable. As required by the Basin Plan, CTR, SIP, and 40CFR122.47, compliance should be as short as possible. These are only applicable for discharges north of the Dumbarton Bridge because applicable criteria for the south bay are different than those cited above.

- For pollutants where there are planned TMDLs or SSOs, and final WQBELs may be affected by those TMDLs and SSOs, maximum timeframes may be appropriate due the uncertain length of time it takes to develop the TMDL/SSO.
- However, for pollutants without planned TMDLs or SSOs, the State Board in the EBMUD remand order (WQO 2002-0012), directs the Regional Board to establish schedules that are as short as feasible in accordance with requirements.

[2] The Basin Plan provides for a 10-year compliance schedule for implementation of measures to comply with new standards as of the effective date of those standards. This provision has been construed to authorize compliance schedules for new interpretations of existing standards, such as the numeric and narrative water quality objectives specified in the Basin Plan, if the new interpretations result in more stringent limits than in the previous permit.

- a. For the numeric standards and objectives in place prior to the SIP (these include the 1995 Basin Plan objectives, and NTR criteria that were implemented in accordance with the Basin Plan), due to the adoption of the SIP, the Water Board has newly interpreted these objectives and standards. The effective date of this new interpretation is the effective date of the SIP (April 28, 2000) for implementation of these numeric Basin Plan objectives.

Fact Sheet Appendix F-9

- b. For numeric objectives for the seven pollutants adopted in the 2004 Basin Plan (amendments), the Water Board has newly adopted these objectives. The effective date of these new objectives is the approval date of the 2004 Basin Plan by U.S. EPA (January 5, 2005) for implementation of these numeric Basin Plan objectives. December is the last full month directly preceding the sunset date. Compliance should be set on the first day of the month to ease determination of monthly average limits. Therefore, compliance must begin on January 1, 2015.
- c. For narrative objectives, the Board must newly interpret these objectives using best professional judgment as defined in the Basin Plan for each permit. Therefore, the effective date of this new interpretation will be the effective date of the permit.

[3] The schedules established in permits effective prior to the 2004 Basin Plan (amendments) should be continued into subsequent permits reissued after the 2004 Basin Plan. For example, Permit XX, adopted Nov 2004 became effective Feb 1, 2005. Permit XX establishes a compliance schedule for copper to end April 1, 2010. When next reissued in 2010, the compliance deadline for the same copper limit should remain April 1, 2010. However, if in applying the 2004 BP objective results in a more stringent limit for copper, then a new compliance schedule may extend to the new date in 2015, provided discharger XX justifies the need for the longer compliance schedule.

[4] Permits effective after SIP/CTR that specified 5-yr compliance schedules pursuant to SIP §2.1 for CTR pollutants do not qualify for another compliance schedule for those same CTR pollutants during reissuance.

- a. An exception to this would be if new data collected during the term of the permit results in more stringent limitations, then a compliance schedule may be allowable for the more stringent limits up to May 18, 2010.
- b. Another exception applies to pollutants granted a compliance schedule pursuant to the 2000 SIP §2.2.2, Interim Requirements for Providing Data (note 2005 SIP amendment deleted this section as it is not applicable to permits effective after May 18, 2003). Because SIP §2.1 provides for a maximum 5-year compliance schedule, and permittees granted §2.2.2 schedules have not been previously granted such a schedule under §2.1, those permittees who can demonstrate infeasibility to achieve immediate compliance with limits calculated using the data collected, qualify for a §2.1 schedule up to the maximum statutory date (April 28, 2010).

Cyanide was one pollutant for which the Water Board granted a §2.2.2 compliance schedule to collect better ambient data for cyanide, because the Regional Monitoring Program data were not complete primarily due to inadequate detection limits. BACWA and WSPA funded an effort to collect these data as part of the collaborative receiving water monitoring for other CTR pollutants. The Regional Water Board has received these data, which form the basis for current permits. However, upon further consideration, the SIP §2.2.2 compliance schedule was granted in error, because cyanide is an NTR criterion and not a CTR criterion, and the SIP compliance schedule provisions apply to "...CTR criterion and/or effluent limitations." Thus, it is more appropriate to apply the Basin Plan's compliance schedule provision, which was the implementation tool for NTR criteria prior to the SIP superceding the provisions in the Basin Plan related to calculation of water quality based effluent limitations. As such, the compliance schedule for cyanide should follow note [2a], above.

Fact Sheet Appendix F-10

Mercury Mass Limit and Trigger Calculation

Fact Sheet Appendix F-11
Discharger's Infeasibility Analysis
June 6, 2006

Infeasibility Analyses, Calistoga Wastewater Treatment Plant

Introduction

The City of Calistoga (City) received correspondence from the San Francisco Bay Regional Water Quality Control Board (Regional Water Board) dated May 15, 2006 regarding the Regional Water Board's results of its reasonable potential analysis as well as requesting infeasibility analyses for four priority toxic pollutants subject to the *Policy for Implementation of Toxics Standards for Inland Surface Waters, Enclosed Bays and Estuaries of California* (known as the State Implementation Policy (SIP), effective 4/28/00 and amended 7/13/05). Infeasibility analyses for priority pollutants (constituents listed in the SIP) are required for the Regional Water Board to issue interim limits and compliance schedules for these constituents. The infeasibility analyses contained herein for the two priority pollutants have been conducted in accordance with section 2.1 of the SIP. The analyses contained herein are submitted to the Regional Water Board by the City to demonstrate the City's inability to comply with water-quality based effluent limits for copper, cyanide, chlorodibromomethane, and dichlorobromomethane for discharge from the Calistoga Wastewater Treatment Plant.

Background

The SIP establishes statewide policy for National Pollutant Discharge Elimination System (NPDES) permitting. The SIP provides for the situation where an existing NPDES discharger cannot immediately comply with an effluent limitation derived from a California Toxics Rule (CTR) or more stringent toxic Basin Plan criterion. The SIP allows for the adoption of interim effluent limits and a schedule to come into compliance with the final limit in such cases. To qualify for interim limits and a compliance schedule, the SIP requires that an existing discharger demonstrate that it is infeasible to achieve immediate compliance with the CTR based limit.

The term "infeasible" is defined in the SIP as "not capable of being accomplished in a successful manner within a reasonable period of time, taking into account economic, environmental, legal, social and technological factors."

The SIP requires that the following information be submitted to the Regional Water Board to support a finding of infeasibility:

- (a) documentation that diligent efforts have been made to quantify pollutant levels in the discharge and sources of the pollutant in the waste stream, including the results of those efforts;
- (b) documentation of source control and/or pollution minimization efforts currently under way or completed;
- (c) a proposed schedule for additional or future source control measures, pollutant minimization or waste treatment; and
- (d) a demonstration that the proposed schedule is as short as practicable.

Pollutants to be Evaluated

The pollutants for which an infeasibility analysis and compliance schedule justification were requested by the Regional Water Board in its May 15, 2006 correspondence for the City's Wastewater Treatment Plant are copper, cyanide, chlorodibromomethane, and dichlorobromomethane.

Effluent Limit Attainability

The proposed final effluent limits contained in the Administrative Draft version of the Calistoga NPDES Permit are compared to the maximum observed effluent concentrations at the Wastewater Treatment Plant in Table 1 (no dilution credit).

Table 1. Proposed Effluent Limits for the City of Calistoga Wastewater Treatment Plant

Pollutant	Water Quality Based Effluent Limits		Effluent Quality
	AMEL ^[a]	MDEL ^[b]	MEC ^[c]
Copper (µg/L)	5.7	9.6	9.0
Cyanide (µg/L)	3.1	9.1	9.2
Chlorodibromomethane (µg/L)	0.41	0.82	4.9
Dichlorobromomethane (µg/L)	0.56	1.1	13

[a] AMEL: average monthly effluent limit

[b] MDEL: maximum daily effluent limit

[c] MEC: maximum effluent concentration

[d] Due to the failure of two or more acid surrogates, this acid compound result should be considered an estimated value.

The final effluent limits shown above are calculated using procedures described in Section 1.4 of the SIP for priority pollutants and non-priority pollutants. Background values were based on data from the Napa River. No dilution credit was used and the receiving water was classified as fresh water with municipal drinking water, aquatic life and agricultural beneficial uses. The receiving water hardness was calculated from the average and standard error (65 mg/L), measured in the Napa River at stations C-1 through C-6, and was used to calculate hardness-based metals objectives and conversion factors. Other variables in the effluent limit calculation included coefficients of variation for different pollutants.

Maximum observed (detected) effluent concentrations are based on recent Wastewater Treatment Plant effluent quality data collected annually from two outfalls over three years (2004, 2005, 2006). As shown in the table above, the City may not be able to comply with proposed effluent limits for the listed constituents. The infeasibility analyses and compliance schedule justifications for the listed constituents are discussed below.

Source Control and Pollution Prevention Efforts

The City has not previously identified copper, cyanide, chlorodibromomethane, or dichlorobromomethane as pollutants of concern and therefore has not conducted pollution prevention activities targeting these constituents. The City participates in general pollution prevention activities through its membership in Bay Area Clean Water Agencies (BACWA). The City has also begun a residential outreach program to reduce oil and grease in the sewer lines, and the distribution of educational materials will begin in June and July 2006. A City web page (www.web.ci.calistoga.ca.us) contains information about the proper disposal of hazardous waste, and the City participates in Napa County's hazardous waste collection/disposal program. Other methods of promoting pollution prevention activities include a quarterly City newsletter, informational inserts in bimonthly water bills, a City Access television station, and pollution prevention information distribution at the PW office.

There are two large industries within the City's jurisdiction, the water bottling companies Calistoga Mineral Water and Crystal Geyser Mineral Water. Discharge from these industries to the treatment plant is controlled by local limits, a maximum allowable discharge volume, and cost per pound for the discharge of conventional pollutants.

Copper

The maximum observed effluent concentration for copper is 9.0 µg/L (measured in May 2004, out of 27 data points) which would exceed a final AMEL of 5.7 µg/L. In addition, four more samples collected between November 2003 and January 2006 have copper concentrations that would exceed the proposed final AMEL. Therefore, the City will not be able to immediately comply with the proposed final limits.

No influent data are available for copper at the Wastewater Treatment Plant, therefore influent sources cannot be determined at this time. Copper in influent is often due to corrosion of copper plumbing in the water distribution system, or from the water supply. Typical industrial and commercial sources of copper in influent include radiator repair shops, automotive machine shops, car washes, printers, and metal finishers.

The City will perform a source identification for copper in the wastewater influent. If commercial sources are significant contributors, appropriate source control programs such as inspections and incentive programs that reward clean business practices and encourage zero-discharge can be developed. If industrial sources are significant contributors, the City will work with its two permitted industries to identify reduction opportunities. If corrosion is a major source, the City will review corrosion control measures used by its water purveyor, and distribute plumbing BMPs to pipe fitters and building inspectors in the City's service area.

The City participated with other permittees through the BACWA with the Regional Water Board, USEPA, and BayKeeper in the development of site-specific objectives for copper for San Francisco Bay north of the Dumbarton Bridge. The work has led to a removal of the 303(d) listing for copper in the Bay and development of draft revised water quality objectives for copper in the Bay.

The effluent data for copper is shown with the proposed final effluent limits in Figure 1. It can be seen that four data points exceed the AMEL, two as recently as May 2005.

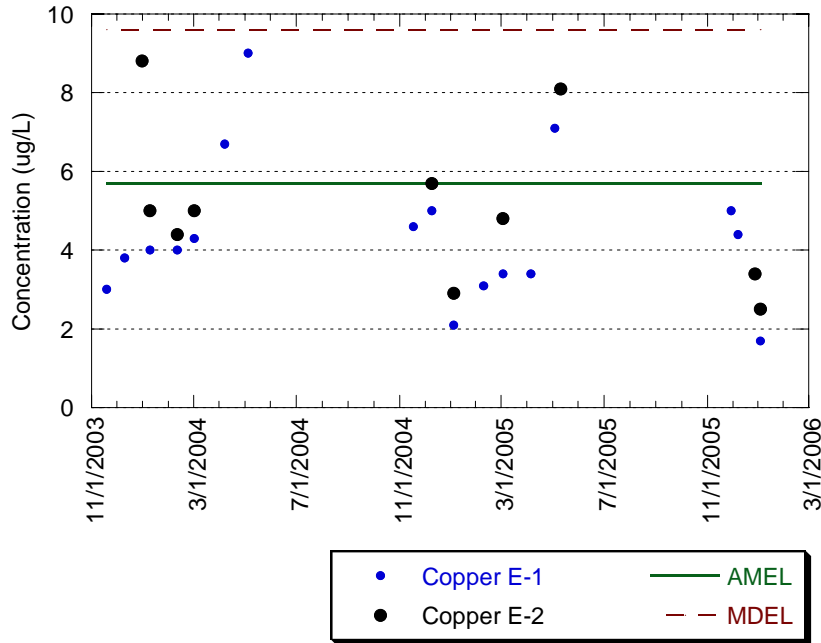

Figure 1. Effluent Copper with Proposed Final Effluent Limits

Cyanide

The maximum observed effluent concentration for cyanide is 9.2 µg/L (measured in May 2005, out of 27 data points) which would exceed a final MDEL of 9.1 µg/L and a final AMEL of 3.1 µg/L. In addition, 11 of 27 samples collected between November 2003 and January 2006 would exceed the proposed final AMEL. The cyanide detection limit is 3 µg/L. Therefore, the City will not be able to immediately comply with the proposed final limits.

As the Regional Water Board has noted previously, “Cyanide is a regional problem associated with the analytical protocol for cyanide analysis due to matrix interferences. A body of evidence exists to show that cyanide measurements in effluent may be an artifact of the analytical method. This question is being explored in a national research study sponsored by the Water Environment Research Foundation (WERF).” No influent data are available for cyanide at the Wastewater Treatment Plant, therefore influent sources cannot be determined at this time. Typically, cyanide is not present in wastewater influent but is generated in the treatment plant disinfection process. The WERF study also indicated that effluent cyanide levels are due to chlorination.

Effluent monitoring for cyanide will continue as required by the City’s NPDES permit, and quarterly influent monitoring for cyanide will be initiated. If half of the influent data are detected at levels exceeding the effluent after two years of monitoring, source identification efforts will be initiated.

The City supports current efforts to develop a site-specific objective (SSO) for cyanide in the Bay through their BACWA affiliation, given that cyanide does not persist in the environment and that the current water quality objective (WQO) was based on testing with East Coast species. A cyanide SSO for Puget Sound, Washington, using West Coast species has been approved by EPA Region X. A final report documenting a regional study for development of a site-specific

objective was submitted to the Regional Water Board on June 29, 2003. The Basin Plan Amendment is currently being developed.

The effluent data for cyanide is shown with the proposed final effluent limits in Figure 2. It can be seen that eleven data points exceed the AMEL, three since May 2005.

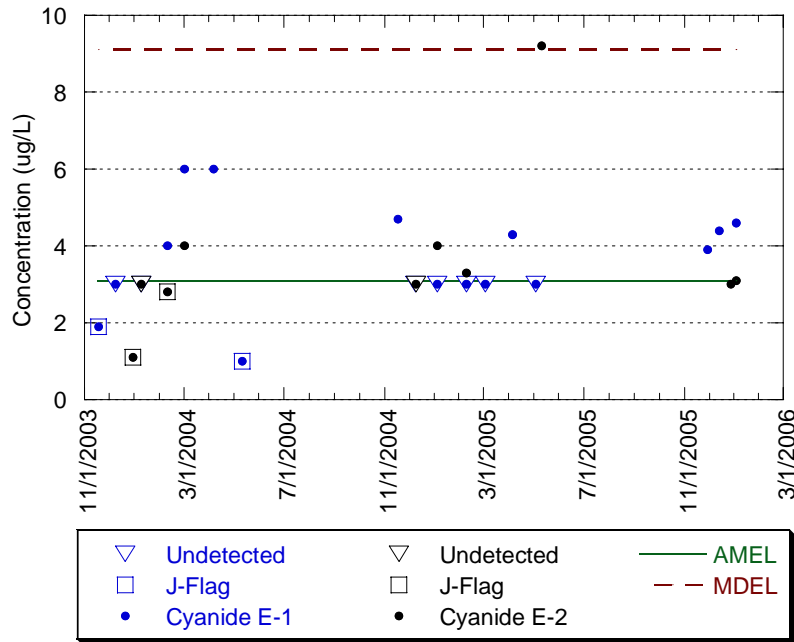

Figure 2. Effluent Cyanide with Proposed Final Effluent Limits

Chlorodibromomethane

The maximum observed effluent concentration for chlorodibromomethane is 4.9 µg/L (measured in January 2005 at outfall E-2, out of 3 samples at each outfall) which would exceed a proposed final MDEL of 0.82 µg/L and AMEL of 0.41 µg/L. In addition, all three samples collected at outfalls E-1 and E-2 have chlorodibromomethane concentrations that would exceed the proposed final AMEL. Therefore, the City will not be able to immediately comply with the proposed final limits.

The City has not previously identified chlorodibromomethane as a problem pollutant and therefore has not initiated source control actions targeting chlorodibromomethane. No influent data are available for chlorodibromomethane at the Wastewater Treatment Plant, therefore influent sources (if any) cannot be determined at this time. However, chlorodibromomethane is a by-product of the chlorination process, therefore the treatment plant’s disinfection process is the most likely source. Typically, for other POTWs, influent sources of chlorodibromomethane are not significant.

Effluent monitoring for chlorodibromomethane will continue as required by the City’s NPDES permit, and bi-annual influent monitoring for chlorodibromomethane will be initiated. If half of the influent data are detected at levels exceeding the effluent after two years of monitoring, source identification efforts will be initiated. If less than half of the influent data are detected at

levels exceeding the effluent after two years of monitoring, efforts will be taken to optimize the chlorination process to decrease the concentration of chlorodibromomethane as a chlorination by-product.

Dichlorobromomethane

The maximum observed effluent concentration for dichlorobromomethane is 13 µg/L (measured in January 2004 at outfall E-1 and January 2005 at Outfall E-2, out of 3 samples at each outfall) which would exceed a proposed final MDEL of 1.1 µg/L and AMEL of 0.56 µg/L. In addition, all three samples collected at outfalls E-1 and E-2 have dichlorobromomethane concentrations that would exceed the proposed final AMEL and MDEL. Therefore, the City will not be able to immediately comply with the proposed final limits.

The City has not previously identified dichlorobromomethane as a problem pollutant and therefore has not initiated source control actions targeting dichlorobromomethane. No influent data are available for dichlorobromomethane at the Wastewater Treatment Plant, therefore influent sources (if any) cannot be determined at this time. However, dichlorobromomethane is a by-product of the chlorination process, therefore the treatment plant's disinfection process is the most likely source. Typically, for other POTWs, influent sources of dichlorobromomethane are not significant.

Effluent monitoring for dichlorobromomethane will continue as required by the City's NPDES permit, and bi-annual influent monitoring for dichlorobromomethane will be initiated. If half of the influent data are detected at levels exceeding the effluent after two years of monitoring, source identification efforts will be initiated. If less than half of the influent data are detected at levels exceeding the effluent after two years of monitoring, efforts will be taken to optimize the chlorination process to decrease the concentration of chlorodibromomethane as a chlorination by-product.

Summary

This evaluation indicates that immediate compliance with proposed final effluent limits for copper, cyanide, chlorodibromomethane, and dichlorobromomethane is not feasible for the City.

In accordance with the requirements of the SIP, the City requests that the Regional Water Board refrain from the adoption of final effluent limits for these constituents. In lieu of final limits, the NPDES permit or compliance order, whichever is applicable, should include interim performance based limits with which the City can comply. The City will continue monitoring and/or implement the source control actions listed in Table 3 for the various constituents as appropriate.

Table 3. Proposed Source Control Actions

Pollutant	Proposed Action	Estimated Time to Complete
Copper	<ul style="list-style-type: none"> • Source identification study • Source control programs for commercial, industrial, corrosion, and water supply sources 	<ul style="list-style-type: none"> • 1 year from permit renewal • Pending results of the source identification study.
Cyanide	<ul style="list-style-type: none"> • Influent monitoring • Source identification study • Participation in development of Site-Specific Objective 	<ul style="list-style-type: none"> • Quarterly, for 2 years after permit renewal • If ½ of the influent concentrations are detected and greater than the effluent concentration, after two years of monitoring. • Ongoing
Chlorodibromomethane	<ul style="list-style-type: none"> • Influent monitoring • Source identification study • Optimization of chlorination process 	<ul style="list-style-type: none"> • Bi-annually, for 2 years after permit renewal • If ½ of the influent concentrations are detected and greater than the effluent concentration, after two years of monitoring. • If less than ½ of the influent concentrations are detected and greater than the effluent concentration, after two years of monitoring.
Dichlorobromomethane	<ul style="list-style-type: none"> • Influent monitoring • Source identification study • Optimization of chlorination process 	<ul style="list-style-type: none"> • Bi-annually, for 2 years after permit renewal • If ½ the influent concentrations are detected and greater than the effluent concentration, after two years of monitoring. • If less than ½ of the influent concentrations are detected and greater than the effluent concentration, after two years of monitoring.

ATTACHMENT G – REGIONAL WATER BOARD ATTACHMENTS

The following documents are part of this Order but are not physically attached due to volume. They are available on the Internet at:

<http://www.waterboards.ca.gov/sanfranciscobay/Download.htm>.

- Self-Monitoring Program, Part A (August 1993)
- Standard Provisions and Reporting Requirements, August 1993
- Regional Water Board Resolution No. 74-10
- August 6, 2001 Regional Water Board staff letter, “Requirement for Monitoring of Pollutants in Effluent and Receiving Water to Implement New Statewide Regulations and Policy”