

***DEVELOPING A DIRECT POTABLE REUSE  
FRAMEWORK DOCUMENT FOR THE  
WATEREUSE ASSOCIATION***

---

**Fifth Meeting**  
**Advisory Group to Expert Panel**  
Sacramento, CA  
May 1, 2015

NATIONAL WATER RESEARCH INSTITUTE  
Fountain Valley, California

***FRAMEWORK DOCUMENT  
INDEPENDENT ADVISORY PANEL***

---

George Tchobanoglous, Panel Chair  
Joseph “Joe” Cotruvo  
James “Jim” Crook  
Ellen McDonald  
Adam Olivieri  
Andrew “Andy” Salveson  
R. Shane Trussell

NATIONAL WATER RESEARCH INSTITUTE  
Fountain Valley, California

## ***ORGANIZATION OF DPR FRAMEWORK DOCUMENT***

---

1. Introduction
2. What is Direct Potable Reuse?
3. Key Components of a Successful/Sustainable DPR Program
4. Public Health Protection
5. Source Control Programs
6. Wastewater Treatment
7. Advanced Water Treatment
8. Purified and Finished Water Management
9. Monitoring and Instrumentation Requirements
10. Residuals Management
11. Facility Operation
12. Public Outreach
13. Future Developments

# ***FORMAT FOR DPR FRAMEWORK DOCUMENT***

---

## *Chapter 1*

### **Introduction**

---

The nation's water supplies are derived from a variety of sources, including local and imported surface water, groundwater, desalinated brackish water and seawater, and recycled water. As a result of population growth, urbanization (especially along coastal regions), and climate change, public water supplies are becoming stressed and the opportunity to develop new groundwater or surface water sources is becoming more difficult, if not impossible. For many of these communities, conservation efforts have reduced the per-capita demand, but are insufficient to meet the overall water need. Consequently, new strategies are needed to help meet future water demands and to develop more sustainable water supplies. One way to meet the increasing demand is to augment public water supplies by means of potable reuse of a community's treated wastewater, which is the focus of this framework document. The following subjects are presented in this introductory chapter:

- What is the difference between direct and indirect potable reuse?
- What is the purpose of framework document?
- What is the scope of framework document?
- What is the organization of framework document?

# ***1. INTRODUCTION***

---

- What is the difference between direct and indirect potable reuse?
- What is the purpose of the framework document?
- What is the scope of the framework document?
- What is the organization of the framework document?

## ***1. PURPOSE OF FRAMEWORK DOCUMENT***

---

To provide an overview of DPR and to provide a framework for assessing the topics and issues that need to be addressed in the development of future DPR Guidelines.

## ***2. WHAT IS DIRECT POTABLE REUSE?***

---

- What is DPR?
- What is IPR?
- What is needed to consider treated wastewater as a new water source?
- What DPR projects are available?
- What does DPR cost?
- What are the energy implications
- How does DPR compare to other sources of water

# 2. OVERVIEW: DIRECT POTABLE REUSE

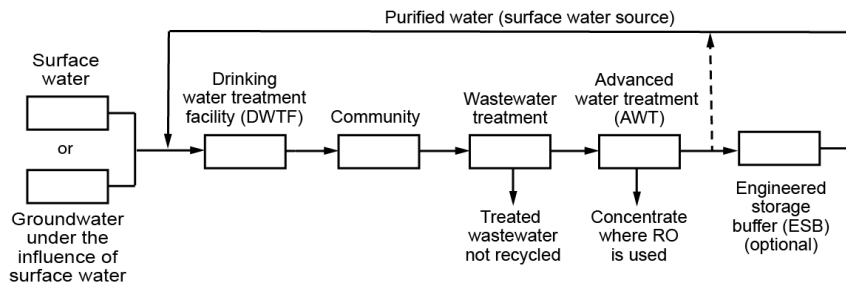

DPR with *purified* water

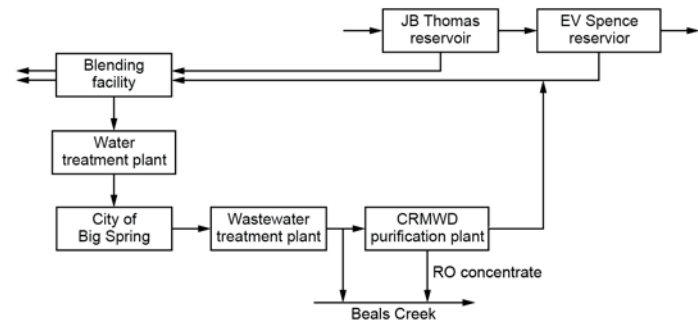

Big Spring, Texas

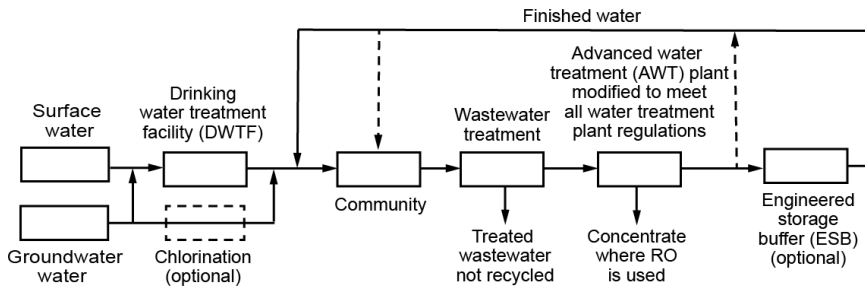

DPR with *finished* water

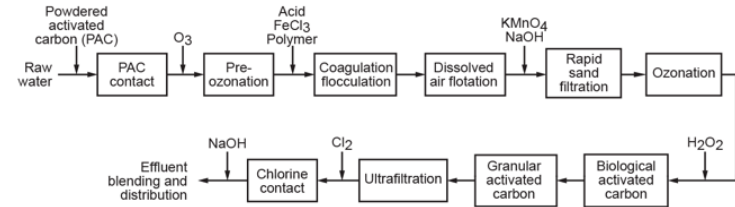

Windhoek, Namibia



## 2. OVERVIEW INDIRECT POTABLE REUSE

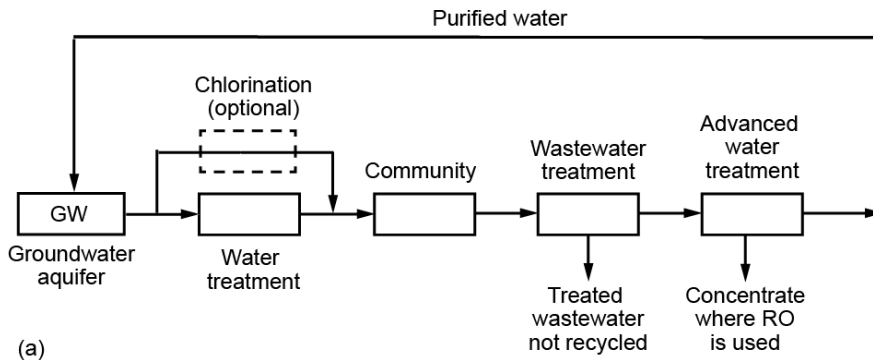

Typical injection well - OCWD

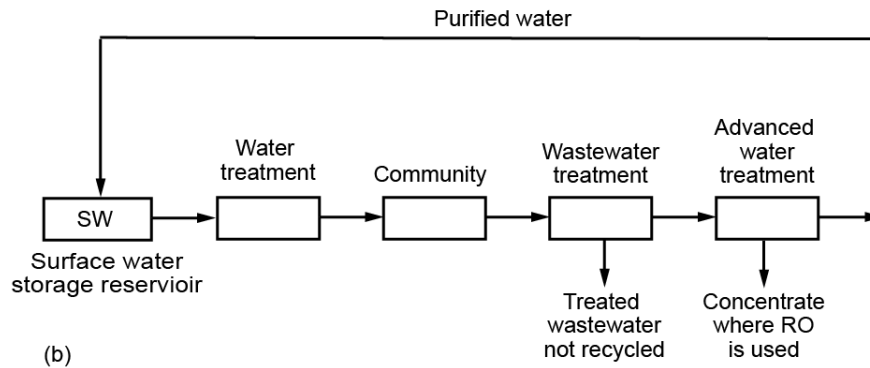

San Vicente reservoir, San Diego, CA

# WHAT DOES DPR COST?

Supply option	Cost, \$/AF			
	Treatment	Residuals Management	Concentrate or brine management	Conveyance and blending facilities
AWT (IPR) with RO	685 - 900	10 - 50	70 - 700	100 - 1,000
AWT (DPR) with RO	700 - 1,000	10 - 50	70 - 700	100 - 1,000
AWT (IPR) without RO	500 - 700	10 - 50	-	100 - 1,000
AWT (DPR) without RO	500 - 800	10 - 50	-	100 - 1,000
Brackish groundwater desalination (inland)	900 - 1,250	20 - 100	70 - 700	300 - 2,000
Sea water desalination	1,800 - 2,100	20 - 100	100 - 200	400 - 3,000
Imported water	400 - 1,300		-	100 - 600
Water use efficiency, conservation, and use restrictions	450 - 950			100 - 400

Note:  $\$/10^3 \text{ gal} \times 325.89 = \$/\text{AF}$

## **DPR ENERGY IMPLICATIONS**

Technology/Water Source	Energy Required			Carbon footprint kg CO <sub>2e</sub> /AF
	Range, kWh/AF	Typical		
		kWh/AF	kWh/10 <sup>3</sup> gal	
Secondary treatment without nutrient removal	330 – 520	450	1.38	244
Tertiary treatment with nutrient removal effluent filtration	520– 670	600	1.84	325
Advanced water treatment	1,050 - 1,140	1080	3.31	585
Ocean desalination	3,100 – 4,900	3,900	11.97	2,112
Brackish water desalination	1,00 – 2,000	1,900	5.83	1,029
California State Project water <sup>e</sup>	3,000 – 5,300	3,300	10.13	1,787
Colorado River water	2,000 - 2,600	2,000	6.14	1,083
Conventional water treatment	120 - 130	124	0.38	43
Membrane based water treatment	140 - 150	145	0.45	79

Note: kWh/10<sup>3</sup> gal x 325.89 = kWh/AF

### ***3. KEY COMPONENTS OF A SUCCESSFUL/SUSTAINABLE DPR PROGRAM***

---

- What are important regulatory considerations?
- What are important technical considerations?
- What are important public outreach considerations?
- What are important regulatory considerations?
- What are technical, operational, and management barriers?
- What are the benefits of implementing DPR?

### ***3. KEY COMPONENTS OF A DPR PROGRAM: TECHNICAL, REGULATORY, AND PUBLIC OUTREACH***

---

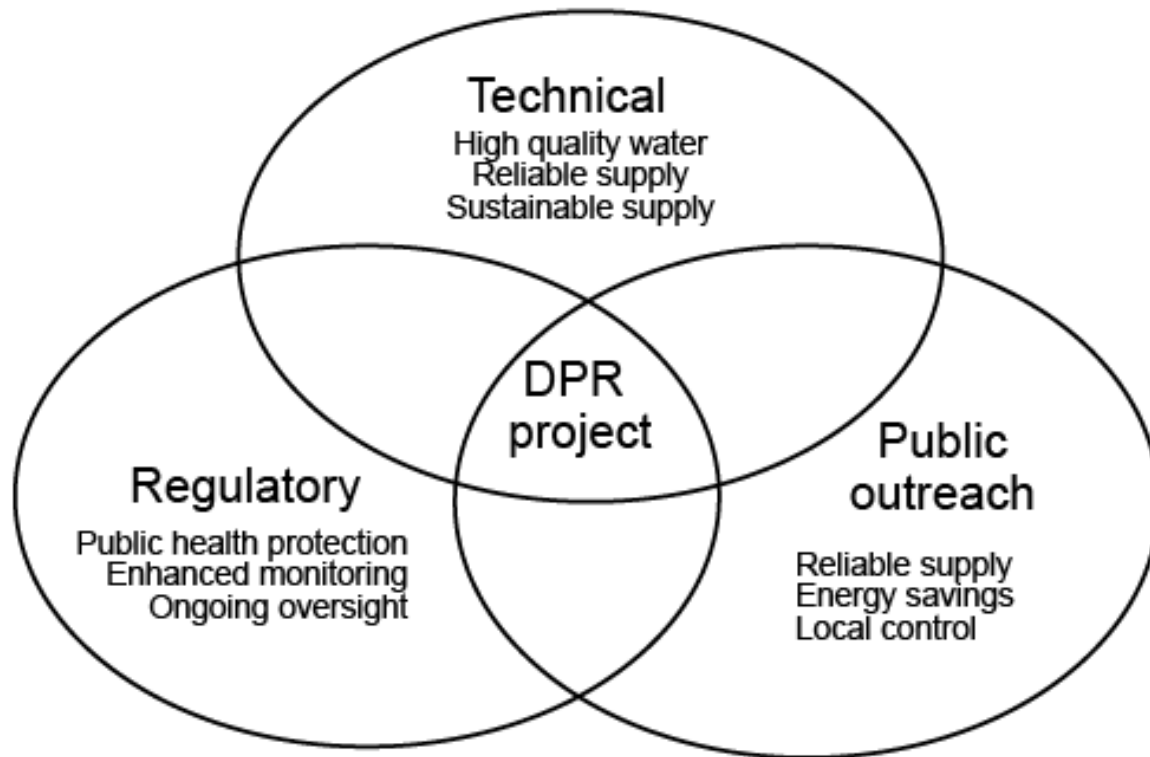

### 3. TECHNICAL, OPERATIONAL, AND MANAGEMENT BARRIERS

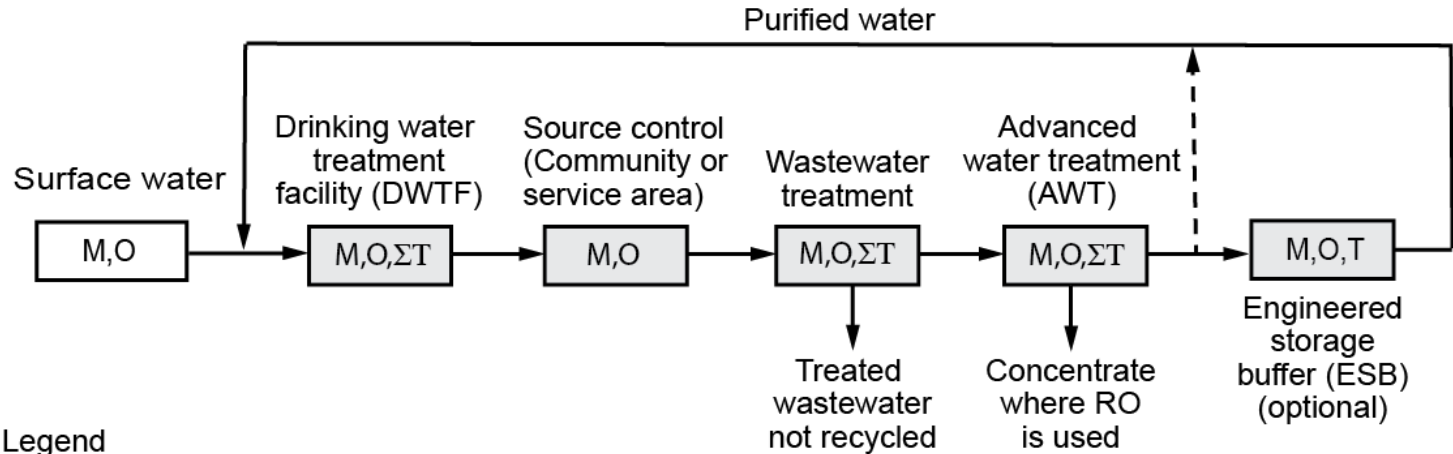

Legend

M = Management barrier

O = Operational barrier

T = Technological barrier

ΣT = Sum of multiple technical barriers

## ***4. PUBLIC HEALTH PROTECTION***

---

- What is public health protection?
- What are the results of health assessments?
- What are the applicable water quality and treatment regulations?
- What are log-reduction values and how do they apply to DPR?
- What regulations would apply to a new third water source?

## 4. LOG-REDUCTION VALUES FOR DPR

Microbial Group	Criterion (log <sub>10</sub> reduction)	Possible surrogates	Source used to develop criteria
Enteric virus	12	MS2 bacteriophage	SWTR (U.S. EPA, 1989a); CDPH (2011); NRC (2012); NRMHC-EPHC-NHMRC (2008)
<i>Cryptosporidium spp.</i>	10	Latex microspheres, AC Fine Dust, inactivated <i>Cryptosporidium</i> oocysts, aerobic spores	Interim ESWTR (U.S. EPA, 1998); LT2 ESWTR (U.S. EPA, 2006); CDPH (2011); NRC (2012); NRMHC-EPHC-NHMRC (2008)
Total coliform bacteria	9	NA <sup>c</sup>	Total Coliform Rule (U.S. EPA, 1989b); NRC (2012) risk assessment for salmonella



## ***5. SOURCE CONTROL PROGRAMS***

---

- What is the importance of source control program for potable reuse
- What are the Federal Pretreatment Standards
- What is the legal framework for a source control program
- What are the principal elements of a source control program
- What are realistic source control program expectations

# 5. ELEMENTS OF A SOURCE CONTROL PROGRAM

---

Item	Description
<b>Regulatory authority</b>	
Legal authority	Ensure that the source control program has sufficient legal authority to develop and implement source control measures.
Discharge permits	Ensure that industrial wastewater discharge permits and other control mechanisms can effectively regulate and reduce the discharge of constituents of concern for DPR.
Enforcement	Ensure that the enforcement response program can identify and respond rapidly to discharges of constituents of concern for DPR.
Alternative control programs	Consider alternative control mechanisms such as best management practices (BMPs) or self-certification for zero discharge of pollutants for classes of industries or commercial businesses.

---

## **Assessment of wastewater collection system service area (sewershed)**

---

### **Source investigations**

---

### **Maintenance of current inventory of chemicals and constituents**

---

### **Source control outreach program**

---

### **Source control program response plan for identified constituents**

---

## ***6. WASTEWATER TREATMENT***

---

- What constitutes wastewater treatment
- What are the differences between secondary treatment processes
- What are the issues related to the use of conventional wastewater treatment in direct potable reuse applications
- What are the benefits of using a higher quality effluent in a potable reuse treatment train

# 6. DIFFERENCES BETWEEN SECONDARY WASTEWATER TREATMENT PROCESSES

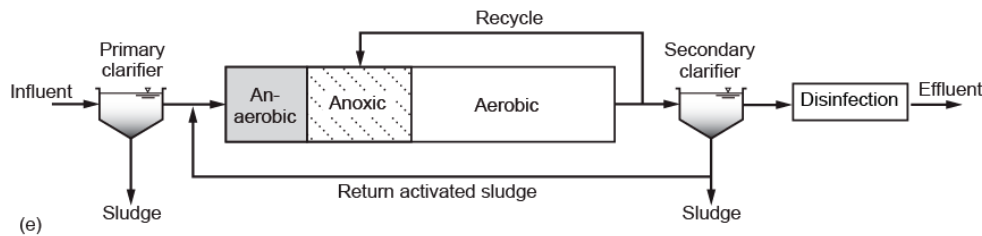
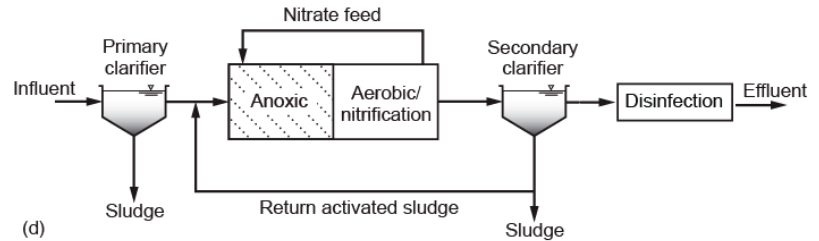
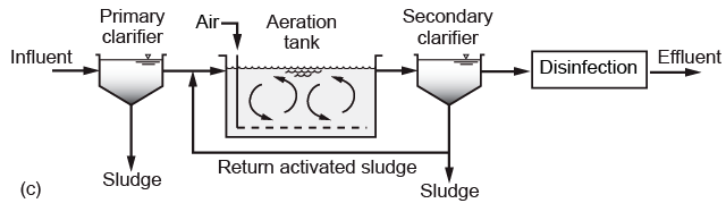
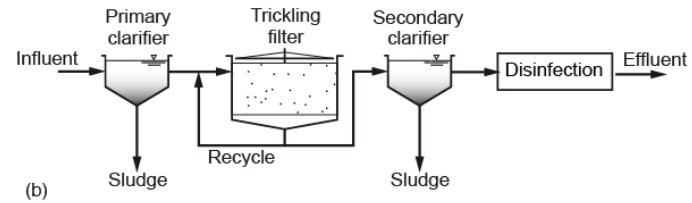
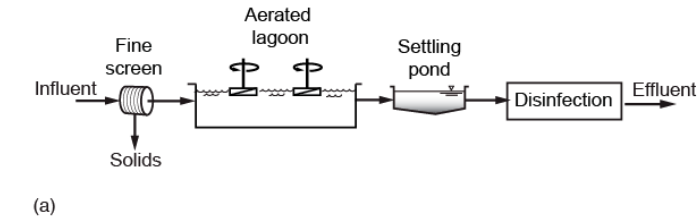

# 6. DIFFERENCES BETWEEN SECONDARY WASTEWATER TREATMENT PROCESSES

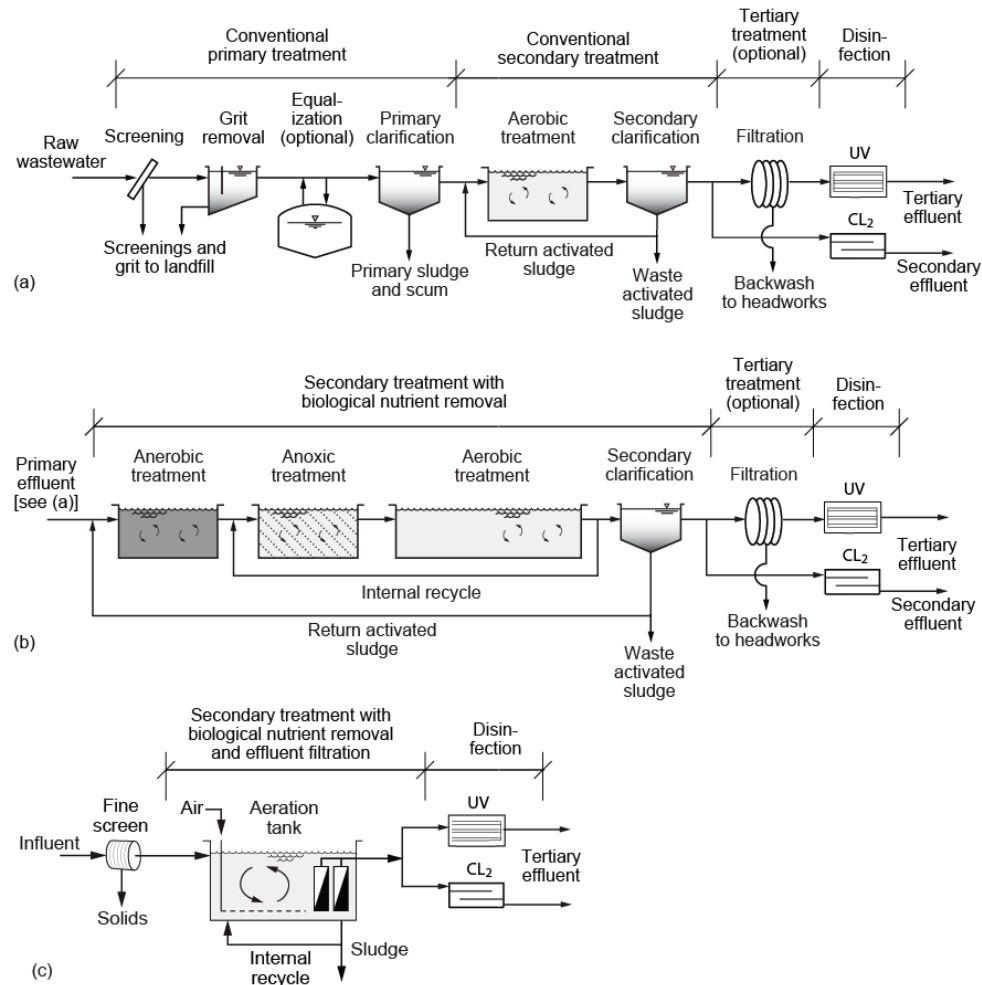

## 6. DIFFERENCES IN EFFLUENT QUALITY BETWEEN ACCEPTED SECONDARY TREATMENT PROCESSES

Constituent	Unit	Untreated wastewater	Range of effluent quality after indicated treatment				
			Conventional activated sludge	Conventional activated sludge with filtration	Activated sludge with BNR	Activated sludge with BNR and filtration	Membrane bioreactor
Total suspended solids (TSS)	mg/L	130 - 389	5 - 25	2 - 8	5 - 20	1 - 4	<1 - 5
Turbidity	NTU	80 - 150	2 - 15	1 - 5	1 - 5	1 - 5	<1 - 2
Biochemical oxygen demand (BOD)	mg/L	133 - 400	5 - 25	< 5 - 20	5 - 15	1 - 5	<1 - 5
Chemical oxygen demand (COD)	mg/L	339 - 1016	40 - 80	30 - 70	20 - 40	20 - 30	<10 - 30
Total organic carbon (TOC)	mg/L	109 - 328	20 - 40	15 - 30	10 - 20	1 - 5	<0.5 - 5
Ammonia nitrogen	mg N/L	14 - 41	1 - 10	1 - 6	1 - 3	1 - 2	<1 - 5
Nitrate nitrogen	mg N/L	0 - trace	5 - 30	5 - 30	<2 - 8	1 - 8	<8 <sup>c</sup>
Nitrite nitrogen	mg N/L	0 - trace	0 - trace	0 - trace	0 - trace	0.001 - 0.1	0 - trace
Total nitrogen	mg N/L	23 - 69	15 - 35	15 - 35	3 - 8	2 - 5	<10 <sup>d</sup>
Total phosphorus	mg P/L	3.7 - 11	3 - 10	3 - 8	1 - 2	≤2	<0.3 <sup>d</sup> - 5
Volatile organic compounds (VOCs)	mg/L	<100 - >400	10 - 40	10 - 40	10 - 20	10 - 20	10 - 20
Iron and Manganese	mg/L	1 - 2.5	1 - 1.5	1 - 1.4	1 - 1.5	1 - 1.5	trace
Surfactants	mg/L	4 - 10	0.5 - 2	0.5 - 1.5	0.1 - 1	0.1 - 1	0.1 - 0.5
Totals dissolved solids (TDS)	mg/L	374 - 1121	374 - 1121	374 - 1121	374 - 1121	374 - 1121	374 - 1121
Trace constituents	mg/L	10 - 50	5 to 40	5 - 30	5 - 30	5 - 30	0.5 - 20
Total coliform	No./100 mL	10 <sup>6</sup> - 10 <sup>10</sup>	10 <sup>4</sup> - 10 <sup>5</sup>	10 <sup>3</sup> - 10 <sup>5</sup>	10 <sup>4</sup> - 10 <sup>5</sup>	10 <sup>4</sup> - 10 <sup>5</sup>	<100
Protozoan cysts and oocysts	No./100 mL	10 <sup>1</sup> - 10 <sup>5</sup>	10 <sup>1</sup> - 10 <sup>2</sup>	0 - 10	0 - 10	0 - 1	0 - 1
Viruses	PFU/100 mL	10 <sup>1</sup> - 10 <sup>4</sup>	10 <sup>1</sup> - 10 <sup>3</sup>	10 <sup>1</sup> - 10 <sup>3</sup>	10 <sup>1</sup> - 10 <sup>3</sup>	10 <sup>1</sup> - 10 <sup>3</sup>	10 <sup>0</sup> - 10 <sup>3</sup>

# 6. DESIGN OF BIOLOGICAL TREATMENT PROCESS FOR ALTERNATIVE END POINT

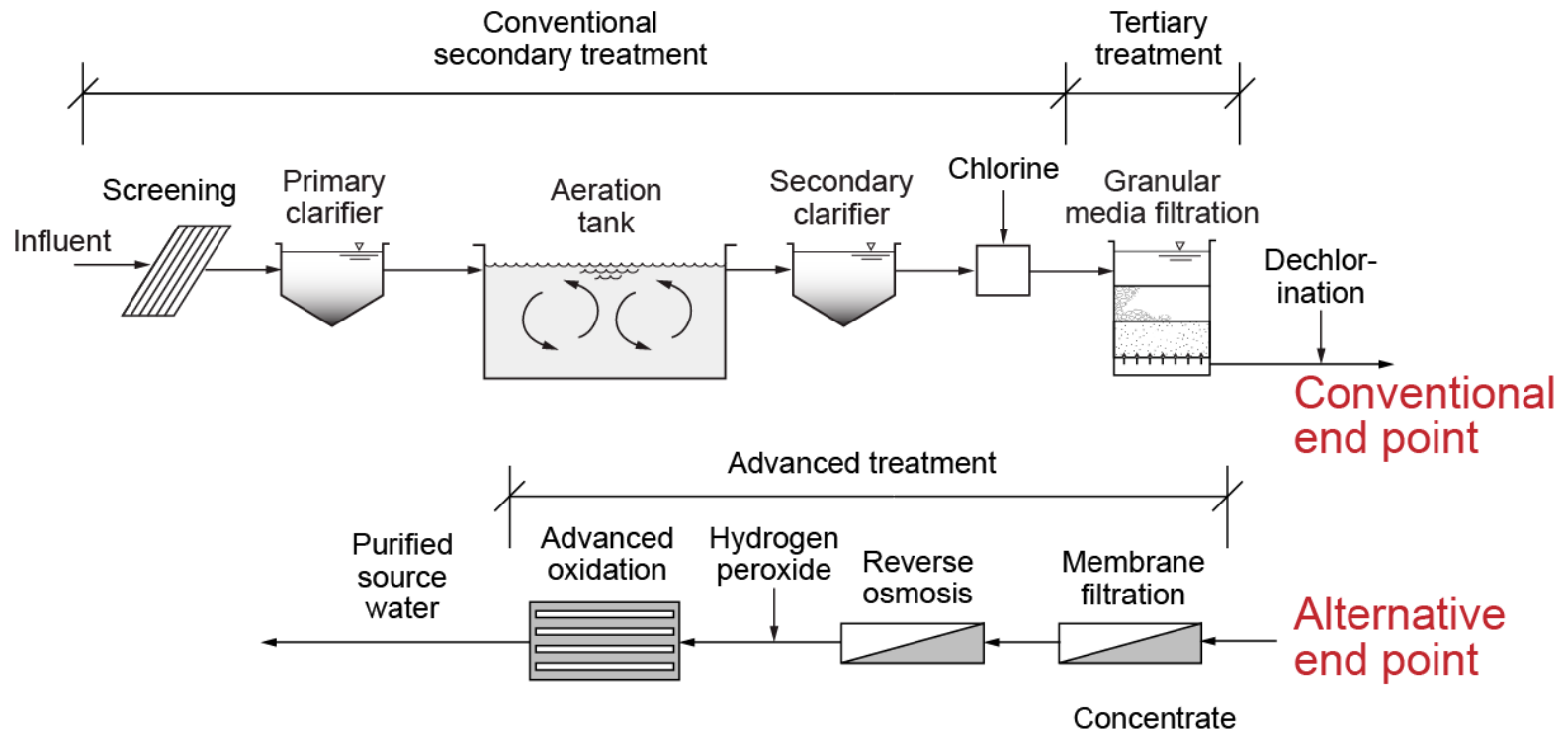

## 6. MEASURES TO IMPROVE PERFORMANCE AND ENHANCE RELIABILITY OF EXISTING WWTPs

Measure	Value of each <u>measure</u> <sup>a</sup>
Enhanced screening process and possibly fine screening (2-6 mm)	Efficiency, reliability
Influent flow equalization	Efficiency, reliability
Elimination (or Equalization) of untreated return flows	Water quality, reliability
Operational mode for biological treatment process	Water quality, reliability
Effluent filtration and disinfection	Water quality, reliability
Improved process monitoring	Water quality, reliability

<sup>a</sup>Efficiency – the recommended improvement increases the overall cost efficiency of operation. *Water quality* – the recommended improvement increases the final potable water quality.

*Reliability* – the recommended improvement



## 6. Alternative Technologies for Enhanced Primary Treatment: Cloth Screen (250-300 $\mu\text{m}$ )

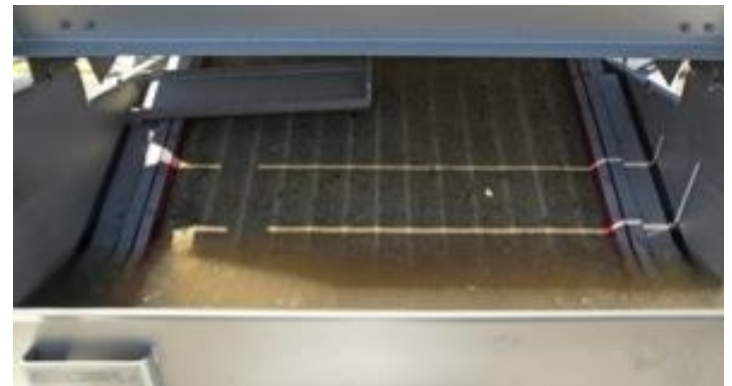
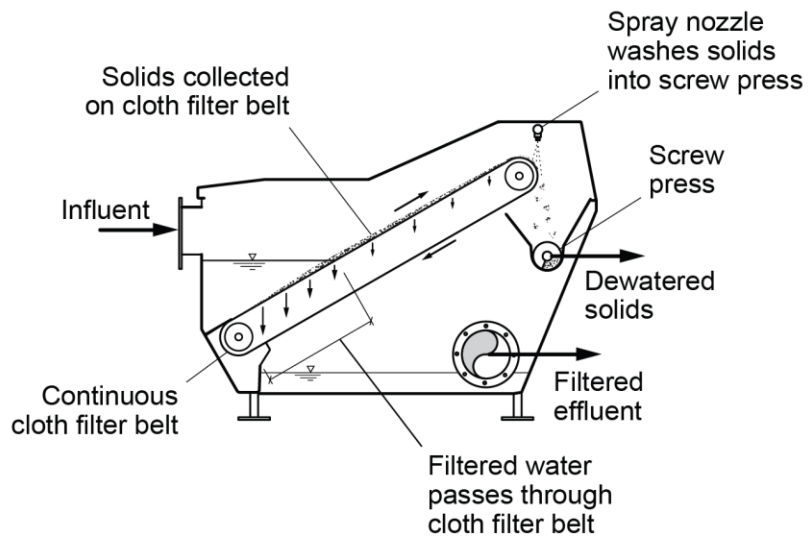
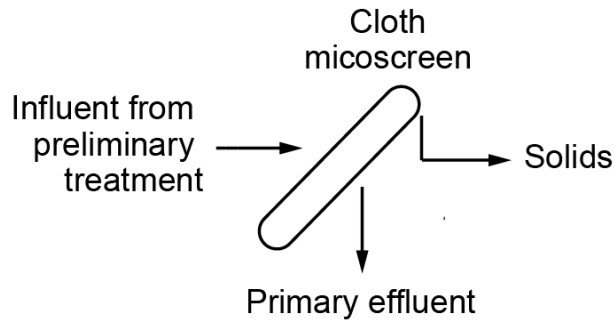

## 6. ALTERNATIVE TECHNOLOGIES FOR ENHANCED PRIMARY TREATMENT: CLOTH DISK FILTER (5-10 $\mu\text{m}$ )

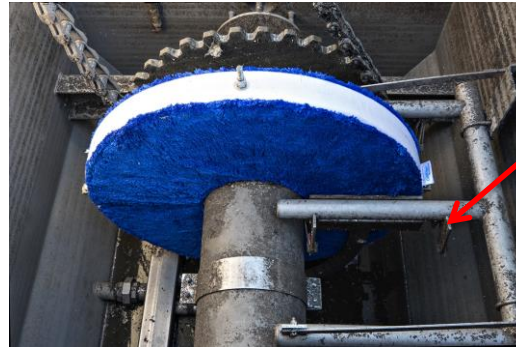
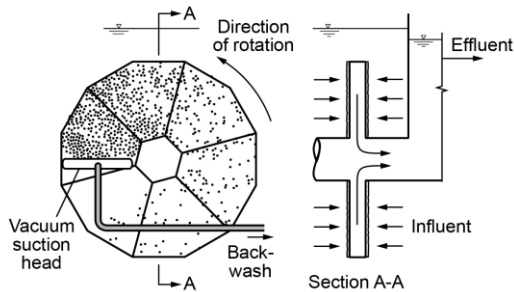

Vacuum suction head

Fiber thickness = 0.007 mm  
 Depth filter L/D = 400 to 800  
 Cloth filter L/D = 425 to 725

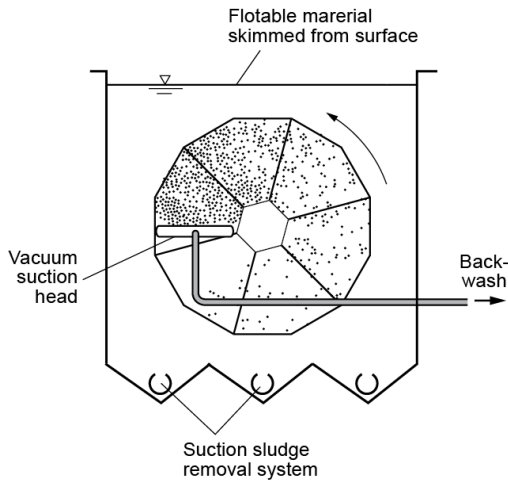

Parameter	Unit	Average influent	Average effluent	Average removal, %
BOD	mg/L	169	59	64.2
COD	mg/L	417	147	62.8
TSS	mg/L	221	26	87.5
VSS	mg/L	116	36	69.0
Turbidity	NTU	143	37	73.5
TKN	mg/L	39	36	7.7
FOG	mg/L	14	10	28.6
UVT	%	28	44	+59.9

## 6. Alternative Technologies for Enhanced Primary Treatment: Charged Bubble Flotation

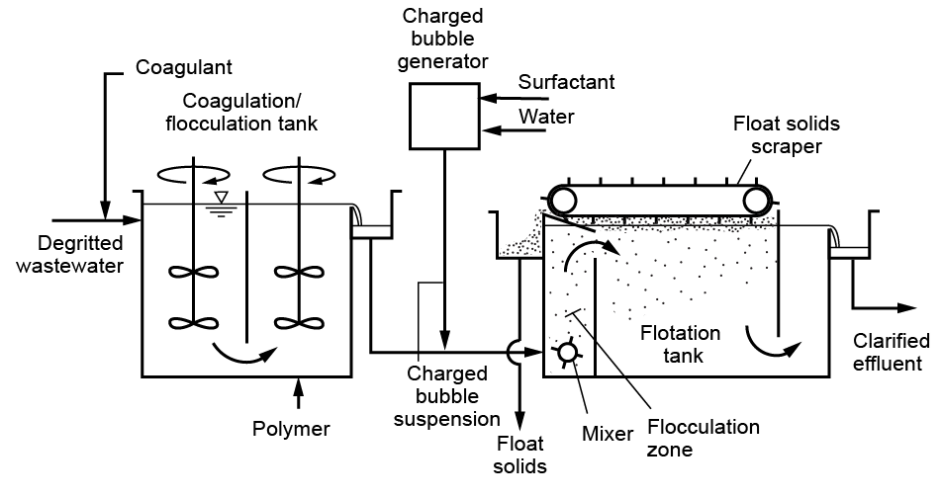

- 1/5<sup>th</sup> the size of conventional clarifiers
- Nanoparticles can be added to charged bubble for removal of specific constituents

# Charged Bubble Flotation for Algal Pond Effluent Reuse

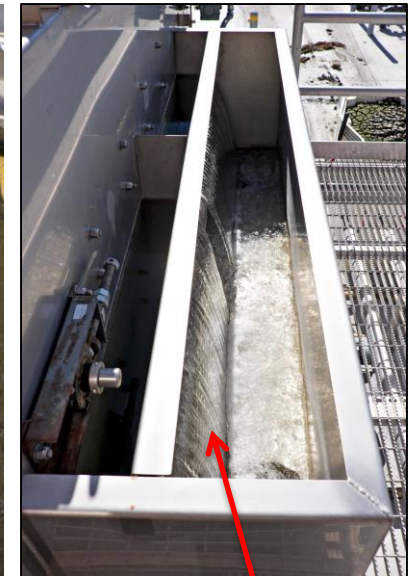
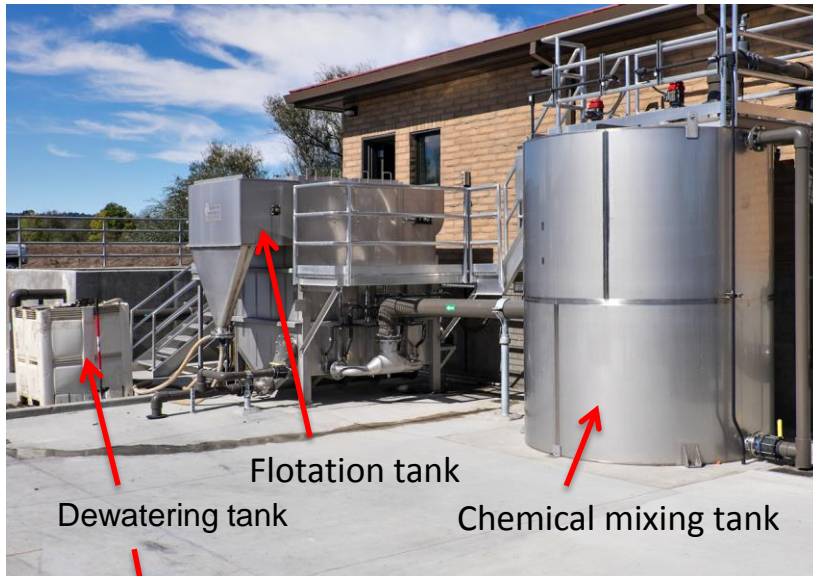

Algae dewatered on straw bed

***OTHER ISSUES THAT IMPACT  
WASTEWATER TREATMENT  
CLIMATE CHANGE AND  
DECREASING PER CAPITA FLOWRATES***

# Impact of Climate Change on Rainfall Intensity and Operation of WWTPs

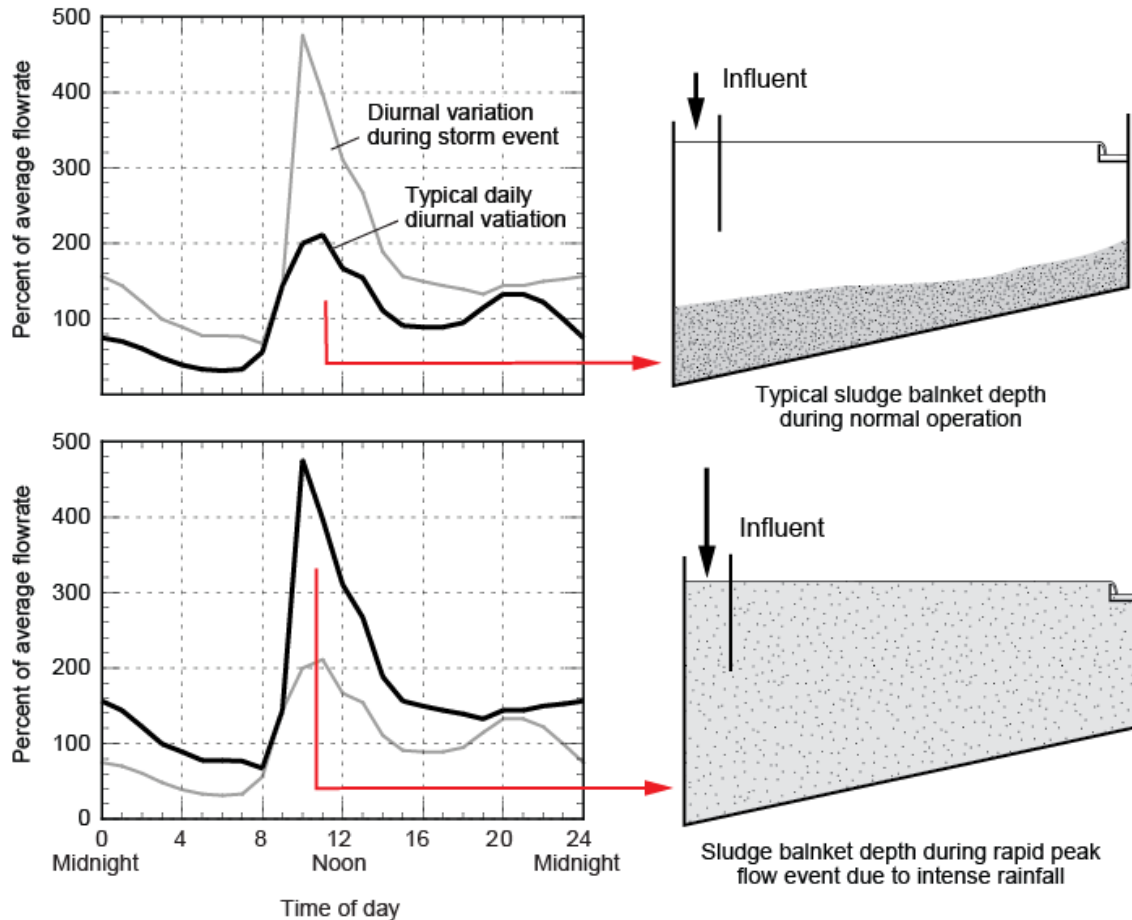

# Impact of Decreasing Flowrates on Operation of Collection Systems and WWTPs

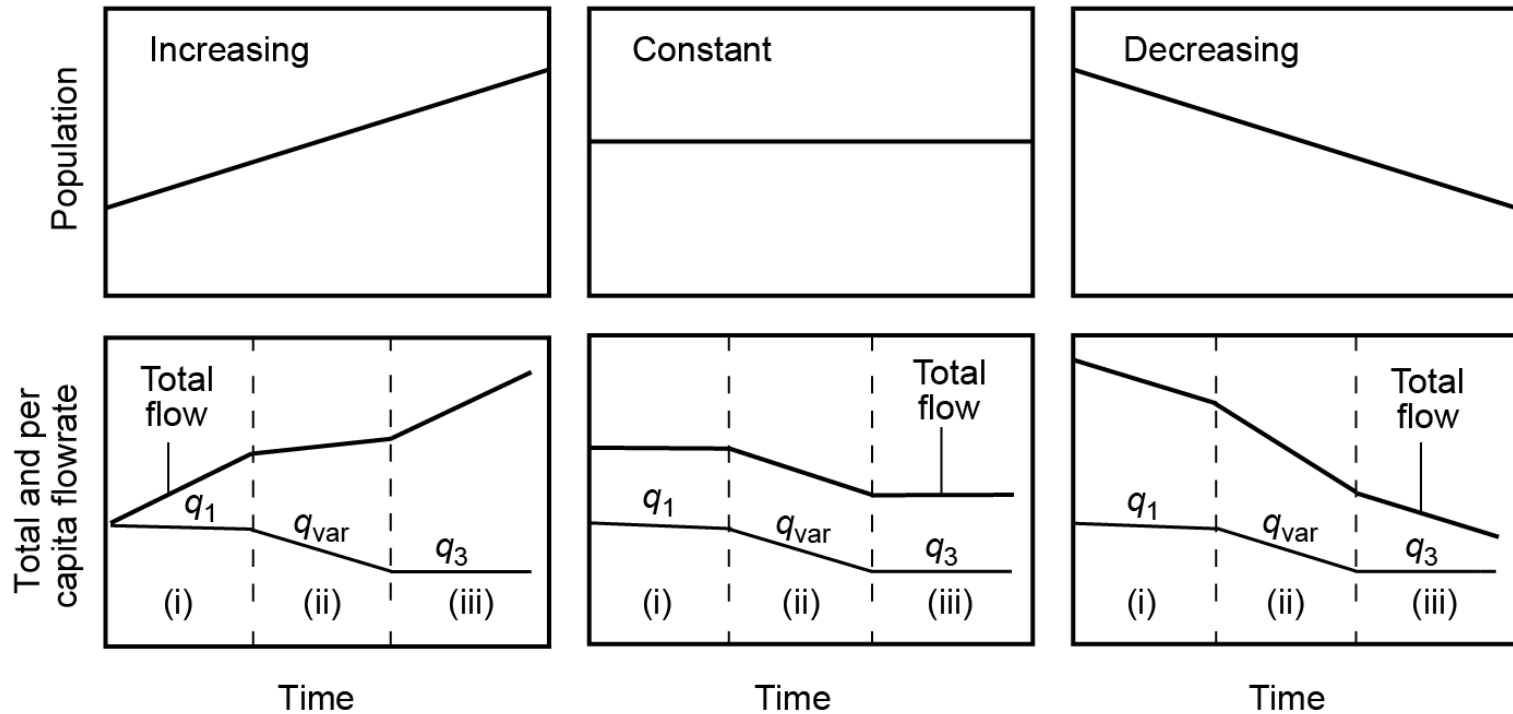

$q$  = per capita wastewater flowrate

(i) Pre-1992

(ii) Improved water conservation, period end point unknown

(iii) Maximum water conservation

# Impact of Water Conservation and Drought: Solids Deposition, H<sub>2</sub>S Formation, and Downstream Corrosion due to Reduced Flows

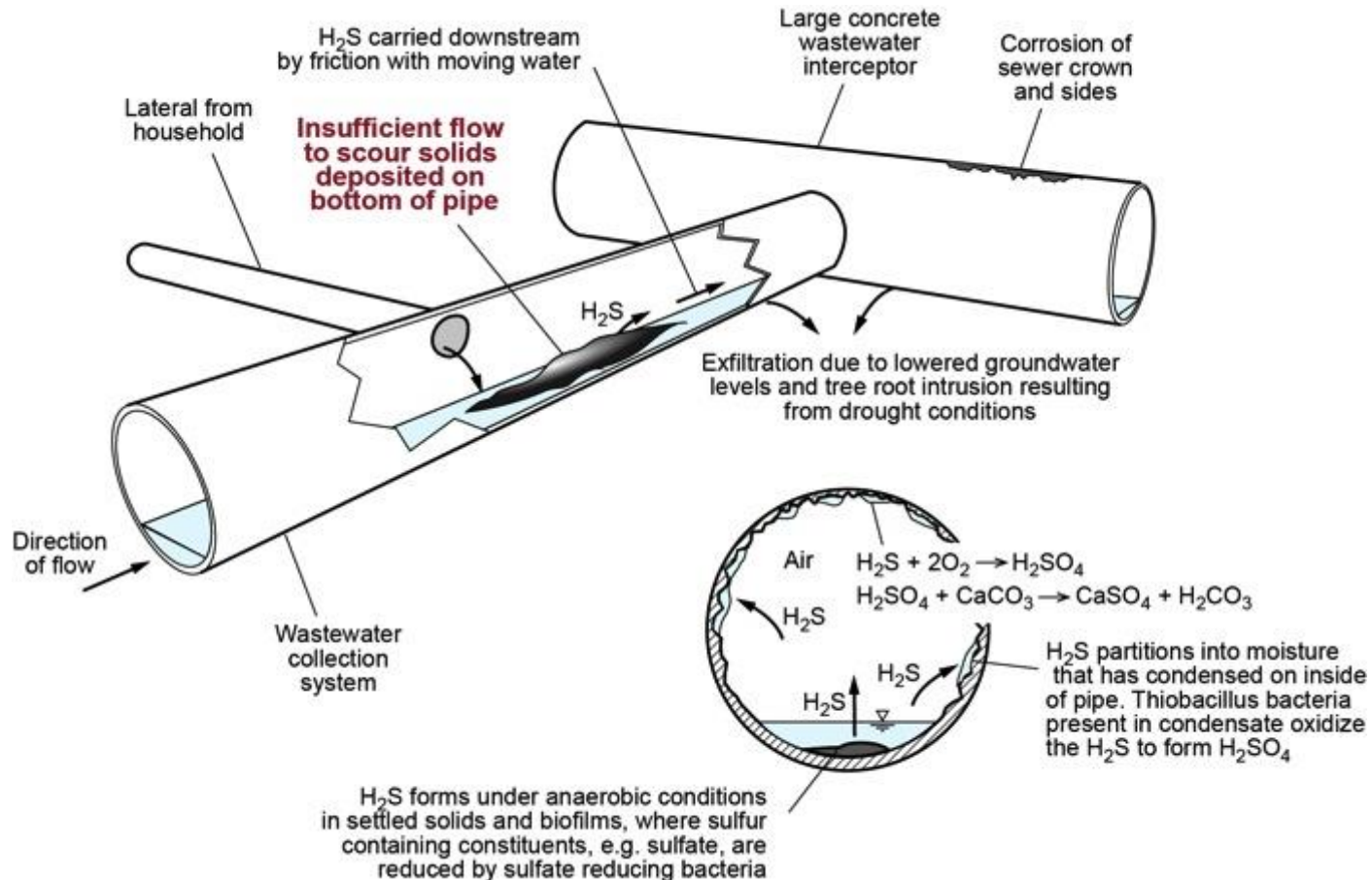



# Alternative Collection Systems for Source Separated Resource Streams

---

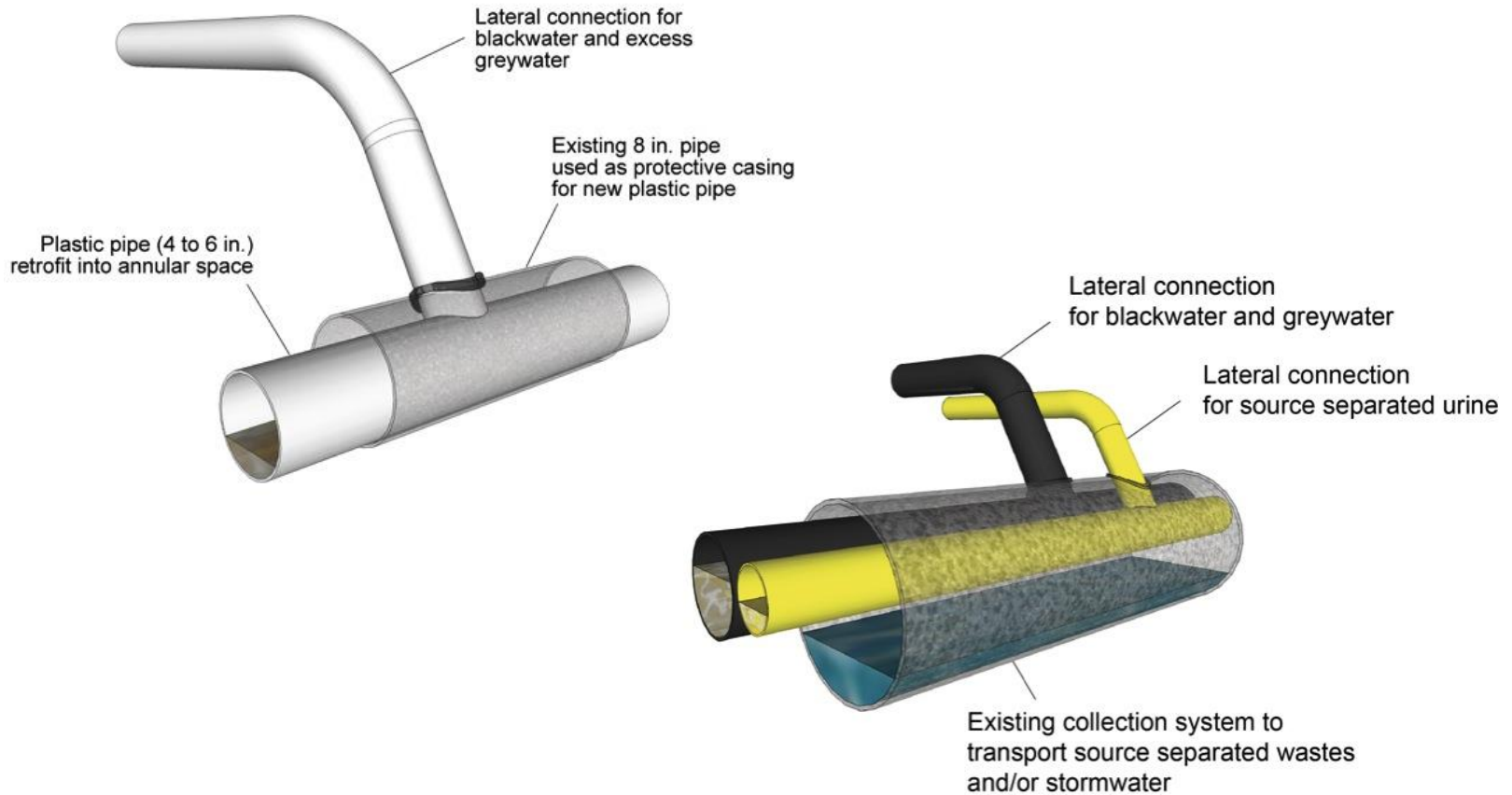

***Impacts of Water Conservation on Treatment Plant Capacity (Approximately 30 Percent Excess Tankage Available, but not Distributed Uniformly)***

---

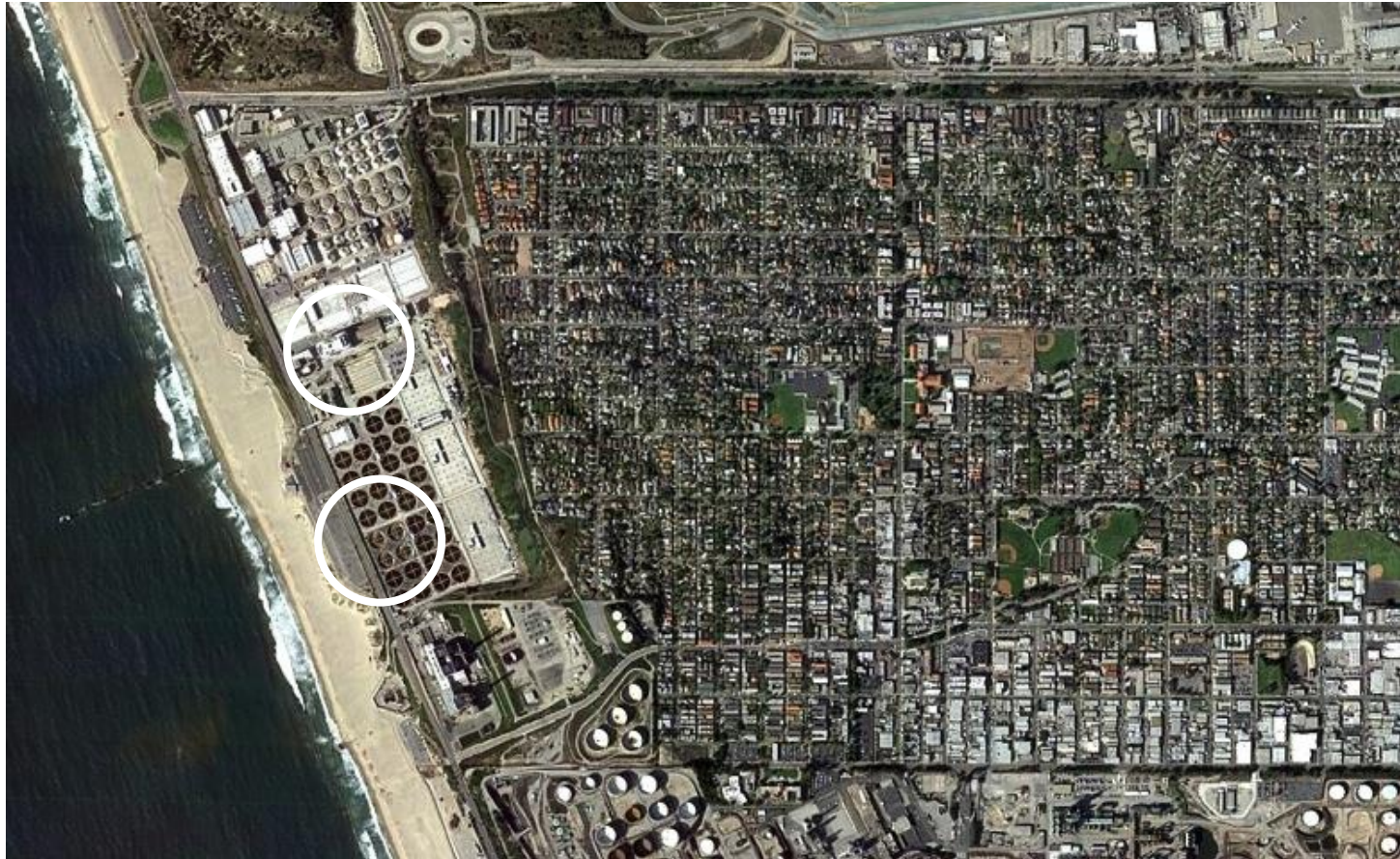

# Impact of Chaos Theory on Achieving Low Effluent Constituent Concentrations

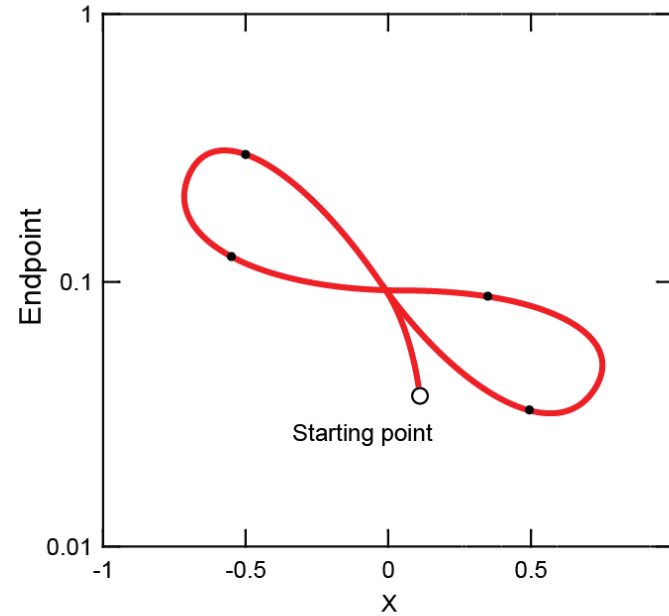
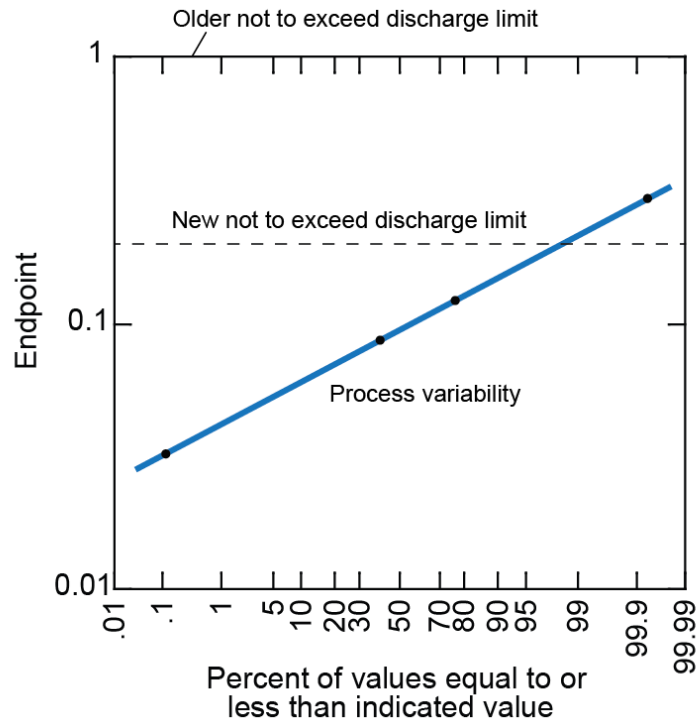

## ***7. ADVANCED WATER TREATMENT***

---

- What are the objectives of advanced water treatment?
- What are typical examples of treatment trains for advanced water treatment?
- What are the performance levels for advanced treatment processes, including determination of pathogen log reduction credit?
- What is the reliability of various treatment trains based on redundancy, robustness, and resilience?
- What happens to the flows when AWT plant must be taken off-line?
- What is use of engineered storage buffers (ESB)?

# 7. TYPICAL TREATMENT TRAINS FOR ADVANCED WATER TREATMENT

---

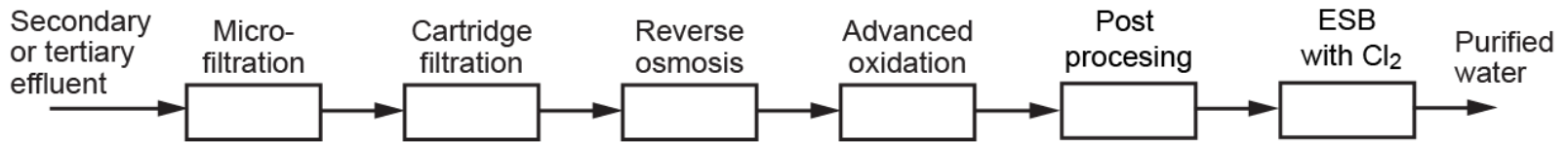

(a)

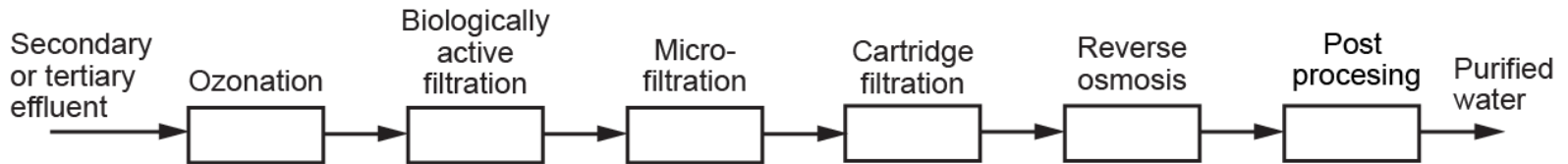

(b)



(c)

# TECHNOLOGIES FOR THE INDIRECT AND DIRECT POTABLE REUSE

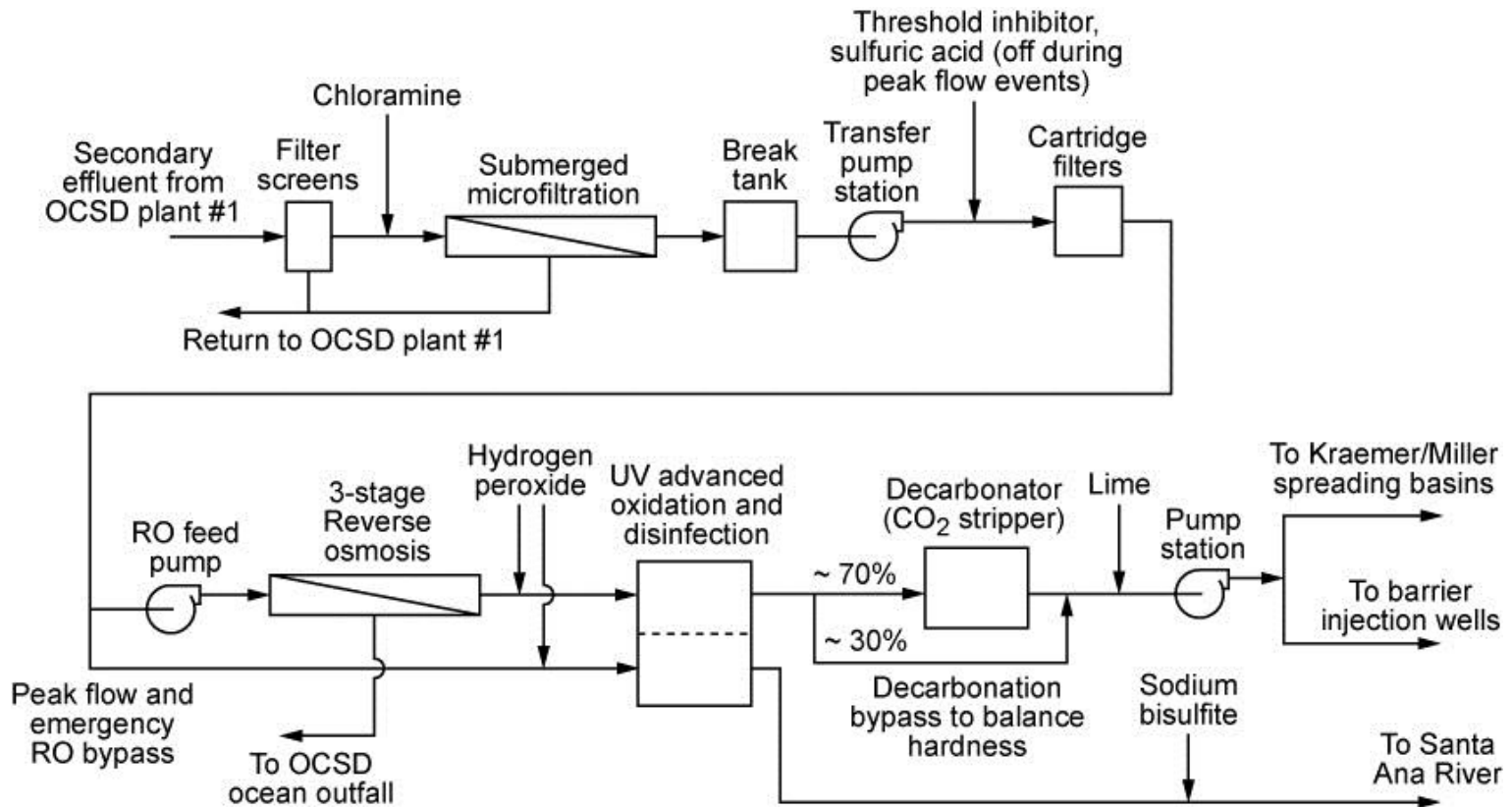

Adapted from OCWD

# *Microfiltration, Cartridge Filters, Reverse Osmosis, and Advanced Treatment (UV) Technologies at OCWD*

---



## **7. DIFFERENCES IN EFFLUENT QUALITY BETWEEN ADVANCED WATER TREATMENT PROCESSES**

Constituent	Unit	Range of effluent quality after indicated treatment				
		Untreated wastewater	Conventional activated sludge with filtration	Activated sludge with O <sub>3</sub> BAF	Activated sludge with MF and RO	Activated sludge with MF, RO, and UV-AOP
Total suspended solids (TSS)	mg/L	130 - 389	2 - 8	1-2	≤1	≤1
Turbidity	NTU	80 – 150	1 - 10	≤1	≤0.1	≤0.1
Biochemical oxygen demand (BOD)	mg/L	133 - 400	< 5 - 20	≤1	≤1	≤1
Chemical oxygen demand (COD)	mg/L	339 - 1016	30 - 70	≤10 - 30	≤2 - 10	≤2 - 10
Total organic carbon (TOC)	mg/L	109 - 328	15 - 30	2 - 5	0.1 - 1	0.1 - 1
Ammonia nitrogen	mg N/L	14 - 41	1 - 6	≤0.1	≤0.1	≤0.1
Nitrate nitrogen	mg N/L	0 - trace	5 - 30	5 - 30	≤1	≤1
Nitrite nitrogen	mg N/L	0 - trace	0 - trace	≤0.001	≤0.001	≤0.001
Total nitrogen	mg N/L	23 - 69	15 - 35	≤1	≤1	≤1
Total phosphorus	mg P/L	3.7 - 11	2 - 6	2 - 6	≤0.5	≤0.5
Volatile organic compounds (VOCs)	mg/L	<100 – >400	10 - 40	≤1	≤1	≤1
Iron and manganese	mg/L	1 – 2.5	1 - 1.4	≤ 0.3	≤ 0.1	≤ 0.1
Surfactants	mg/L	4 - 10	0.5 - 1.5	≤0.5	≤0.1	≤0.1
Totals dissolved solids (TDS)	mg/L	374 - 1121	374 - 1121	374 - 1121	≤5 - 40	≤5 - 40
Trace constituents <sup>a</sup>	mg/L	10 - 50	5 - 30	≤0.1	≤0.1	≤0.1
Total coliform	No./100 mL	10 <sup>6</sup> – 10 <sup>10</sup>	10 <sup>3</sup> - 10 <sup>5</sup>	350	<1	<1
Protozoan cysts and oocysts	No./100 mL	10 <sup>1</sup> – 10 <sup>5</sup>	0 -10	≤0.002	≤0.002	≤0.002
Viruses	PFU/100 mL	10 <sup>1</sup> – 10 <sup>4</sup>	10 <sup>1</sup> - 10 <sup>3</sup>	≤0.03	≤0.03	≤0.03



## 7. PATHOGEN REMOVAL VALUES FOR TREATMENT TRAINS

Process	Performance monitoring method	Log reduction		
		V	G	C
Total, treatment train 1				
Primary and secondary treatment	No existing method	1	0.	1
MF	Twice daily pressure decay testing	0	4.0	4.0
RO	Online TOC	1.5	1.5	1.5
UV AOP	Intensity sensors	6	6	6
ESB with free Cl <sub>2</sub> , CT = 900 mg·min/L	Online Cl <sub>2</sub>	6	3	0
<b>Total, treatment train 1</b>		<b>13.5</b>	<b>14.5</b>	<b>11.5</b>
Total, treatment train 2				
Primary and secondary treatment	No existing method	1	0.	1
Ozone (O <sub>3</sub> ), minimum CT = 1 mg·min/L	Online O <sub>3</sub> <sup>i</sup>	5	3	0
BAF	None	0	0	0
MF	Daily pressure decay testing	0	4.0	4.0
RO	Online TOC	1.5	1.5	1.5
UV (no AOP)	Intensity sensors	6	6	6
<b>Total, treatment train 2</b>		<b>12.5</b>	<b>10.5</b>	<b>7.5</b>
Total, treatment train 3				
Primary and secondary treatment	No existing method	1	0.	1
Ozone (O <sub>3</sub> ), minimum CT = 1 mg·min/L	Online O <sub>3</sub> <sup>i</sup>	5	3	0
BAF	None	0	0	0
UF	Twice daily pressure decay testing	1	4	4
UV AOP	Intensity sensors	6	6	6
ESB with free Cl <sub>2</sub> , CT = 900 mg·min/L	Online Cl <sub>2</sub>	6	3	0
<b>Total, treatment train 3</b>		<b>18</b>	<b>16</b>	<b>10</b>

## 7. RELIABILITY OF VARIOUS TREATMENT TRAINS

---

Term	Definition as pertaining to DPR	Notes
Redundancy	The use of multiple unit processes to attenuate the same type of constituent	More unit processes in series, even with reduced individual performance, can result in improved overall performance
Robustness	The combination of technologies that address a broad variety of constituents	Broad spectrum treatment is required due to the original water source (wastewater)
Resiliency	The capacity of a DPR system to adapt successfully in the face of threats or disaster	Resilience can mean the ability to simply shut off, or the ability to adjust the level of treatment in response to single or multiple process performance failures

# 7. USE OF ENGINEERED STORAGE BUFFERS (ESB)

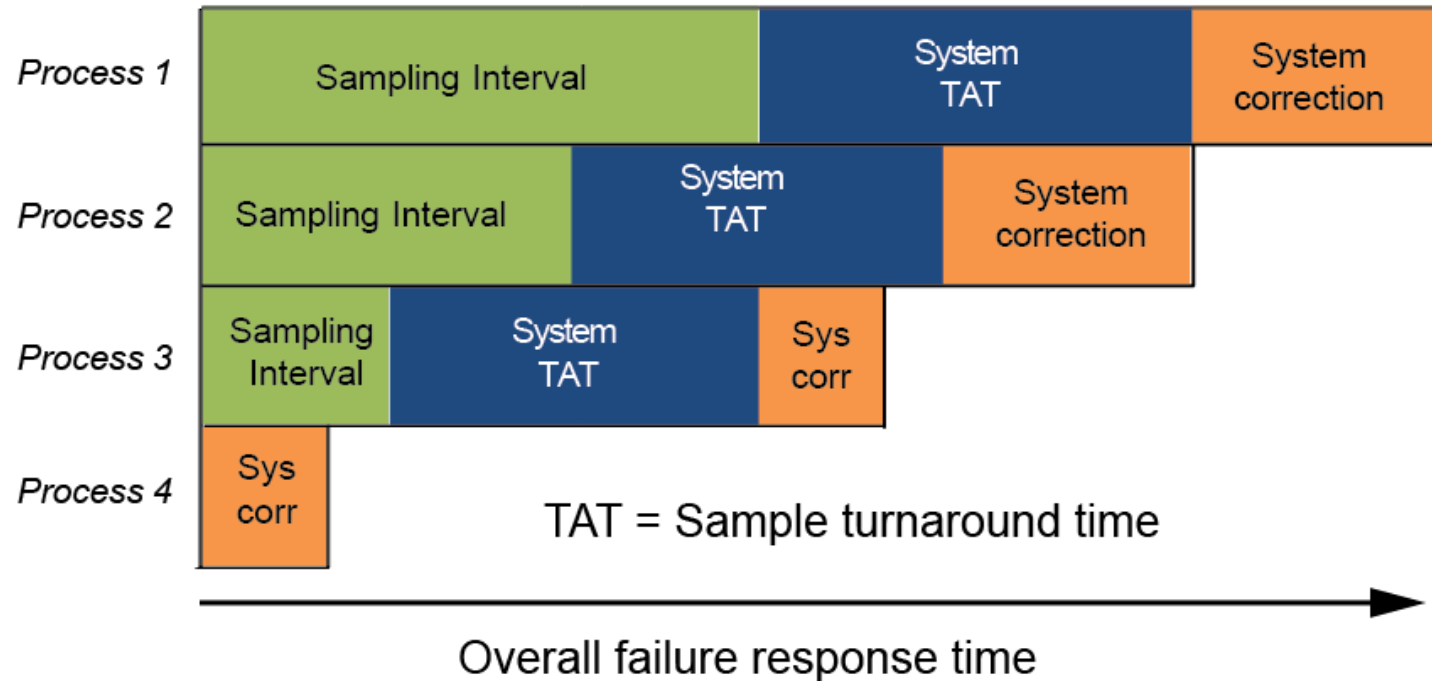

## ***8. PURIFIED AND FINISHED WATER MANAGEMENT***

---

- What potential water quality impacts can result from blending purified water with other raw water sources
- What microbial log reduction credits for can be achieved with water treatment
- What potential water quality impacts can result from blending finished water with other drinking water in the distribution system
- What are appropriate responses to deviations from performance specifications

# 8. FINISHED WATER MANAGEMENT

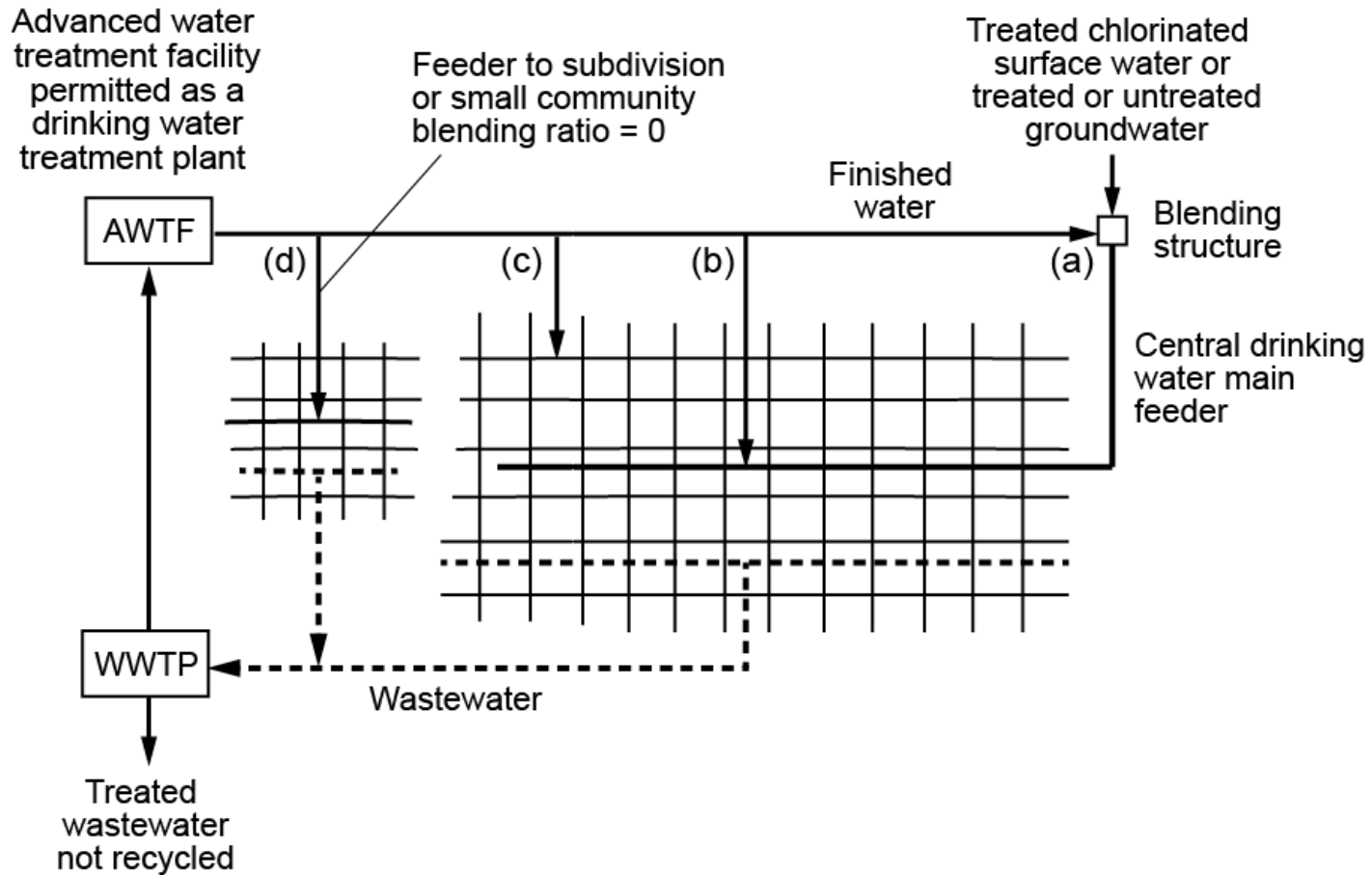

## ***8. BLENDING WITH PURIFIED AND FINISHED WATER***

---

- Blending purified water, **treated with and without RO**, with other source waters before water treatment
- Microbial log reduction credits for water treatment
- Blending finished water, **treated with and without RO**, with other drinking water in the distribution system

## ***8. POTENTIAL WATER QUALITY IMPACTS OF BLENDING PURIFIED WATER WITH SURFACE WATER***

---

- Organic material and nutrients
- Inorganics
- Trace level constituents (e.g., CECs, TOrCs)
- Disinfection stability and DBPs
- Temperature
- Aesthetics
- Pathogens

## ***9. MONITORING AND INSTRUMENTATION REQUIREMENTS***

---

- What are the strategies for process control and monitoring?
- What pathogen credits are allocated for various treatment processes?
- What are the strategies for MCLs, Secondary MCLs, and CECs?
- What constitutes start-up/documentation of baseline performance?
- What are the elements of long-term performance monitoring?



## 9. LONG-TERM ONLINE AND CALIBRATION MONITORING

Process	Test	Grab or online	Frequency of sampling during operation
Secondary Effluent	Turbidity	Both	Online (continuous) and grab (weekly)
	Ammonia, TSS and BOD	Grab	Weekly
UF	PDT	Offline Testing	Daily
	Turbidity	Both	Online (continuous) and grab (weekly)
RO	Influent and Effluent EC and TOC	Both	Online (continuous) and grab (weekly)
UV AOP	UV Sensors	Both	Online (continuous) and grab (weekly)
	Influent UVT	Both	Online (continuous) and grab (weekly)
	Influent and Effluent Chloramine	Both	Online (continuous) and grab (weekly)
ESB with free chlorination	Effluent Free Chlorination	Both	Online (continuous) and grab (weekly)

## ***10. RESIDUALS MANAGEMENT***

---

- What types of residuals are produced from an AWT facility producing purified or finished water?
- What management options are available for non RO concentrate residuals?
- What management options are available for RO concentrate?
- Regulatory concerns with the management of AWT residuals?
- What does residuals management cost?

## ***10. MANAGEMENT OPTIONS FOR RO CONCENTRATE***

---

1. Surface water discharge
2. Discharge to wastewater collection system
3. Deep-well injection
4. Evaporation ponds(without and with greenhouse)
5. Land application
6. Zero liquid discharge (ZLD)
7. RO concentrate discharged through existing wastewater effluent ocean outfall
8. RO concentrate discharged through separate ocean outfall

## 10. MANAGEMENT COSTS FOR RO CONCENTRATE

---

Disposal option	Cost range		Typical cost	
	\$/AF	\$/10 <sup>3</sup> gal	\$/AF	\$/10 <sup>3</sup> gal
Deepwell injection	60 - 80	0.1 – 0.258	70	0.21
Evaporation ponds	140 - 175	0.43 – 0.54	155	0.48
Land application, spray	135-160	0.41 – 0.49	115	0.35
Brine line to ocean	110 - 150	0.35 - 0.38	115	0.35
Zero liquid discharge	700 - 850	2.15 - 2.61	775	2.38

## ***11. FACILITY OPERATION***

---

- What is the importance of facility operation with respect to the production of purified or finished water?
- Why is facility startup and commissioning important?
- What are operator requirements for DPR facilities?
- What are the requirements for an effective facility management program?
- What is an operation plan and how is it developed?

# 11. OPERATOR REQUIREMENTS FOR DPR FACILITIES

---

- Production of **purified** water in an AWT facility not certified as a drinking water plant  
Licensed wastewater operators, but licensed drinking water operators are recommended.
- Production of **finished** water in an AWT facility permitted as a drinking water plant  
Licensed wastewater and drinking water operators.  
Licensed drinking water operators are required by law for a finished water AWT facility.
- Production of **purified** or **finished** water in an AWT facility  
Perhaps a new category of certification “**Advanced Treatment Technologies Operator**” which encompasses water quality, water treatment, and wastewater treatment technologies should be established.

## ***12. PUBLIC OUTREACH***

---

- What constitutes public outreach?
- What are the challenges associated with DPR outreach?
- What is involved in the development of a communication plan?
- What examples of potable reuse outreach programs are available?

## ***13. FUTURE DEVELOPMENTS***

---

- What are future regulatory needs?
- What are future technology needs?
- What are future public outreach needs?



## ***ORGANIZATION OF DPR FRAMEWORK DOCUMENT***

---

1. Introduction
2. What is Direct Potable Reuse?
3. Key Components of a Successful/Sustainable DPR Program
4. Public Health Protection
5. Source Control Programs
6. Wastewater Treatment
7. Advanced Water Treatment
8. Purified and Finished Water Management
9. Monitoring and Instrumentation Requirements
10. Residuals Management
11. Facility Operation
12. Public Outreach
13. Future Developments

## ***A MODEST PROPOSAL FOR WATERREUSE***

---

Use the frame document as the vehicle to access all of the WaterReuse DPR reports online.

For example: IPR regulations have been adopted in a few states such as California  
[http://www.waterboards.ca.gov/drinking/documents/lawbook/RWregulations\\_201406.pdf](http://www.waterboards.ca.gov/drinking/documents/lawbook/RWregulations_201406.pdf),

Virginia

[http://law.lis.virginia.gov/admincode/title9/agency25/chapter\\_740](http://law.lis.virginia.gov/admincode/title9/agency25/chapter_740).